

UFL 26 L PLUG FOR SIGNAL TRANSFER

24 VDC / 1 A - male with LED

Ribbon cable connector + LED
26-pole

Via the combined fixing mechanism, connectors with or without strain relief can be connected.

[Link to Product](#)

Illustration

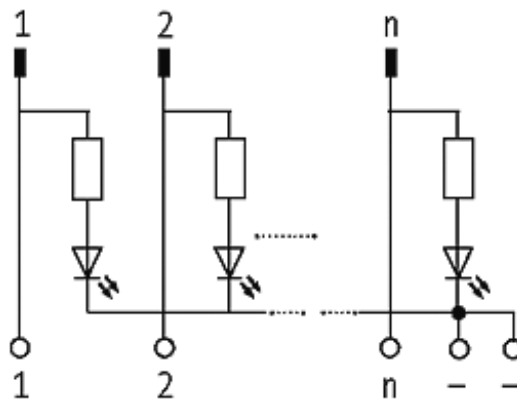

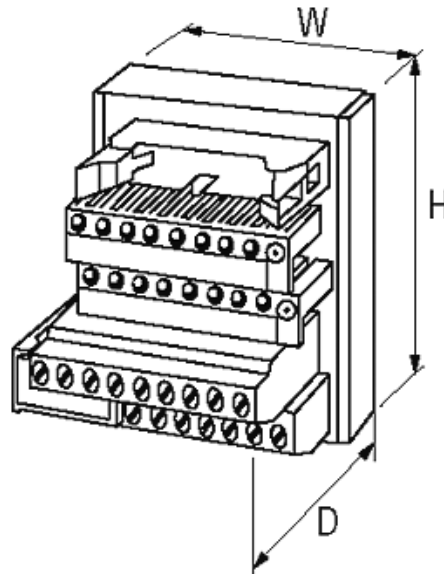

Product may differ from Image

General data

Mounting method	DIN-rail mountable (EN 60715)
Temperature range	-20...+70 °C
Dimensions H × W × D	63×75×48 mm

Commercial data

country of origin	CZ
customs tariff number	85366990
minimum order quantity	1