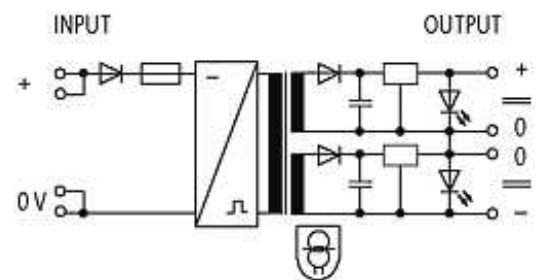

MDD DC/DC-CONVERTOR SWITCH MODE

IN: 24VDC OUT: 2x10V/0,25ADC

INPUT: 24 V DC
OUTPUT: ± 10 V DC
Output rating: 5 W
Current: 2 \times 0.25 A

[Link to Product](#)**Illustration**

stay connected

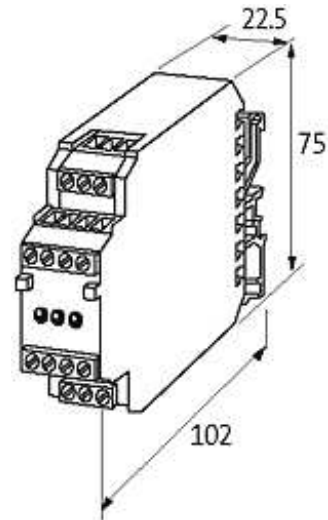

Product may differ from Image

Input

Input voltage	24 V DC
Input current	0.85 A
Input fuse (internal)	1.5 A (T)

General data

Standards	EN 61204-3
Test isolation voltage	4 kV (input/output)
Mounting method	DIN-rail mountable TH35 or G32 (EN 60715)
Temperature range	0...+50 °C, no condensation

Output

Output current	max. 2 × 250 mA
Ripple	max. 0.2 %rms
Output fuse	short-circuit and overload protected, restart after overload by removing power supply
Output voltage	±10 V DC (SELV), ±5 %

Commercial data

country of origin	CZ
customs tariff number	85043121
minimum order quantity	1