

**M12 male 90° shielded B-cod.with cable, Profibus**

PUR 1x2xAWG24 shielded vt UL/CSA+dragchain 1.0m

M12

Male 90°

PROFIBUS, B-coded

2-pole, shielded

Plastic housings with good resistance against chemicals and oils. The resistance to aggressive media should be individually tested for your application. Further details on request. Further cable lengths on request.

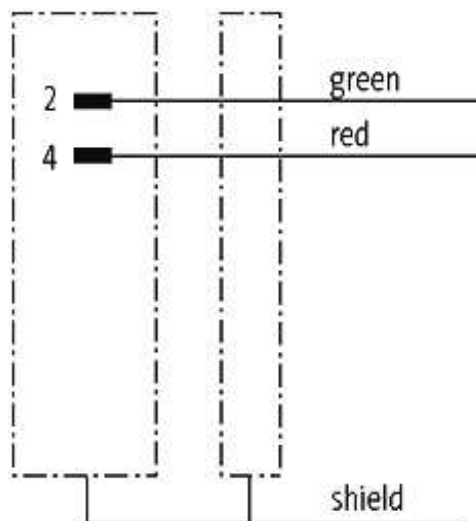
[Link to Product](#)**Illustration**

# Male

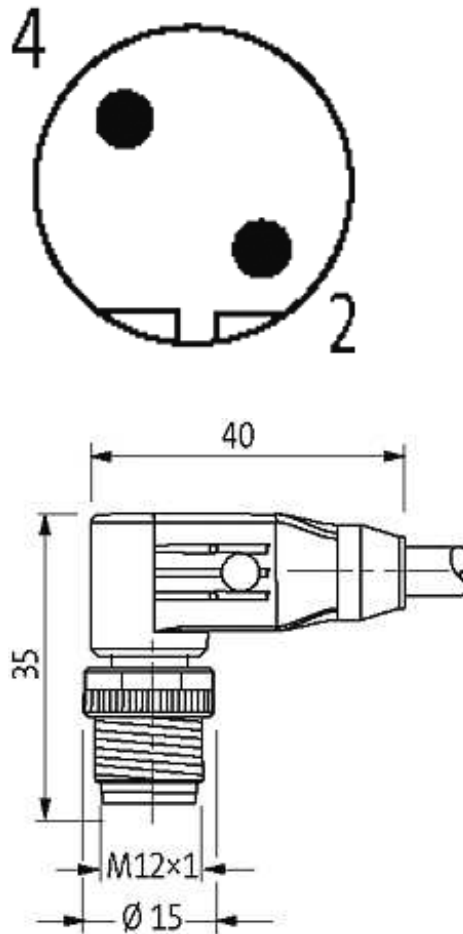

Product may differ from Image

## Approvals



\* only for products with UL/CSA approved cable

## More Info



## Form

Form

14081

## Cables

Cable number	840
No./diameter of wires	1 × 2 × Ø 0.64 mm, (violet)
Wire isolation	PE (rd, gn)
C-track properties	10 Mio.
Jacket Color	violet
Shore hardness outer jacket	90 ± 5A
Material (jacket)	PUR (UL/CSA), Highspeed C-track
Outer Ø	approx. 7.8 mm
Bend radius (fixed)	10 × outer Ø
Bend radius (moving)	15 × outer Ø
Temperature range (fixed)	-40...+80 °C
Temperature range (mobile)	-20...+60 °C
Shielded	yes

#### General data

Temperature range	-25...+85 °C, depending on cable quality
-------------------	--

#### Technical Data

Operating voltage	max. 60 V AC/DC
Operating voltage (only UL listed)	max. 30 V AC/DC
Operating current per contact	max. 4 A
Locking of ports	Screw thread M12 × 1 mm (recommended torque 0.6 Nm) self-securing
Locking material	Zinc die casting, matte nickel plated
Protection	IP66K, IP67 inserted and tightened (EN 60529)

#### Commercial data

country of origin	DE
customs tariff number	85444290
minimum order quantity	1