

M12 MALE 0°

PUR 4X0.75 GRAY, UL/CSA 7m

M12

Male straight

4-pole

Art.-No. 7005 - M12 Lite - (plastic hexagonal screw) on request

Plastic housings with good resistance against chemicals and oils. The resistance to aggressive media should be individually tested for your application. Further details on request. Further cable lengths on request.

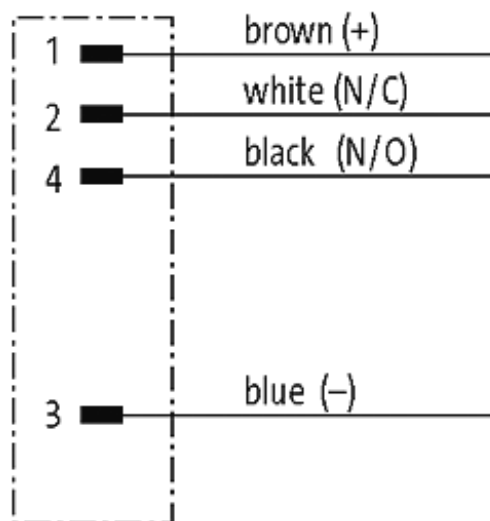
[Link to Product](#)**Illustration**

Male

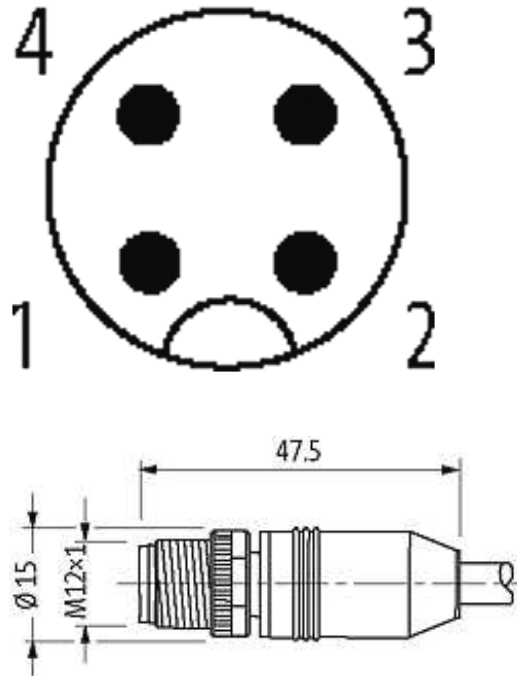

Product may differ from Image

Approvals



Form

Form 12021

Cables

Cable number	862
No./diameter of wires	4 × 0.75 mm ²
Wire isolation	PP (br, wh, bl, bk)
C-track properties	5 Mio.
Jacket Color	gray
Shore hardness outer jacket	85 ± 5A
Material (jacket)	PUR (UL/CSA)
Outer Ø	approx. 6.5 mm
Bend radius (fixed)	7.5 × outer Ø
Bend radius (moving)	10 × outer Ø
Temperature range (fixed)	-40...+80 °C
Temperature range (mobile)	-25...+80 °C

The information in this brochure has been compiled with the utmost care.

Liability for the correctness completeness and topicality of the information is restricted to gross negligence. Version: 05/16

Technical Data

Operating voltage	max. 250 V AC/DC
Operating current per contact	max. 4 A
Locking of ports	Screw thread M12 × 1 mm (recommended torque 0.6 Nm) self-securing
Protection	IP66K, IP67 inserted and tightened (EN 60529)

Commercial data

country of origin	DE
customs tariff number	85444290
minimum order quantity	100