

**M12 FEMALE 90°**

PUR 5X0.75 black UL/CSA, drag ch 15m

M12

Female 90°

5-pole

Plastic housings with good resistance against chemicals and oils. The resistance to aggressive media should be individually tested for your application. Further details on request. Further cable lengths on request.

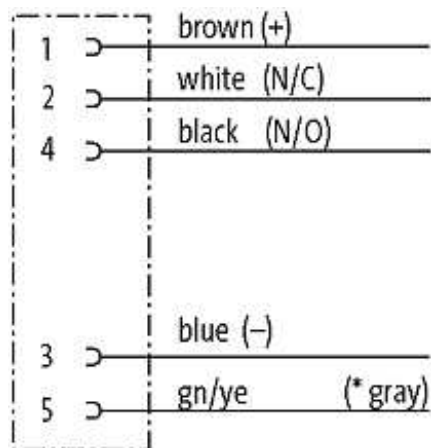
**[Link to Product](#)****Illustration**

(\* for cable type 126, 732, 219, 619)

# Female

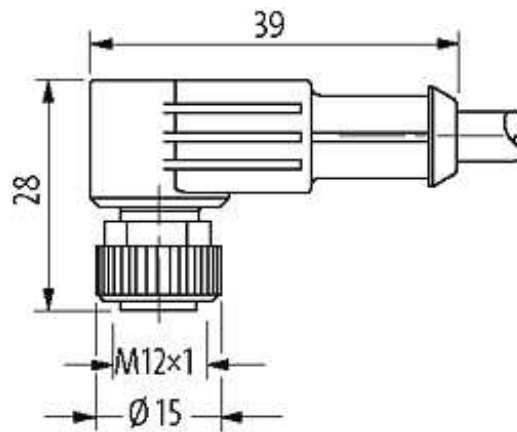
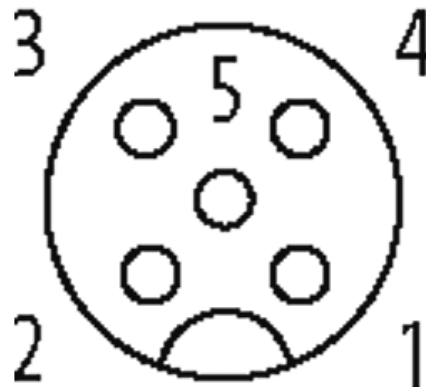

Product may differ from Image

## Approvals



\* only for products with UL/CSA approved cable

## Form

Form 12361

## Cables

Cable number	638
No./diameter of wires	5 × 0.75 mm <sup>2</sup>
Wire isolation	PP (bk num, gnye)
C-track properties	5 Mio.
Torsion	2 Mio. ± 180°/m
Jacket Color	black

Shore hardness outer jacket	90 ± 5A
Material (jacket)	PUR (UL/CSA)
Outer Ø	approx. 7.0 mm
Bend radius (fixed)	5 × outer Ø
Bend radius (moving)	10 × outer Ø
Temperature range (fixed)	-40...+80 °C
Temperature range (mobile)	-25...+80 °C

#### Technical Data

Operating voltage	max. 125 V AC/DC
Operating current per contact	max. 4 A
Locking of ports	Screw thread M12 × 1 mm (recommended torque 0.6 Nm) self-securing
Protection	IP66K, IP67 inserted and tightened (EN 60529)

#### Commercial data

country of origin	DE
customs tariff number	85444290
minimum order quantity	1