

## MICO ELECTRONIC AUXILIARY CIRCUIT, 4 CHANNELS

IN: 24VDC OUT: 24V/1-2-4-6ADC

MICO 4.6

4 channels

Current adjustment 1, 2, 4, 6 A

Fire protection (EN 60950-1) Operating voltage protection (EN 61131-2)

### [Link to Product](#)

#### Illustration

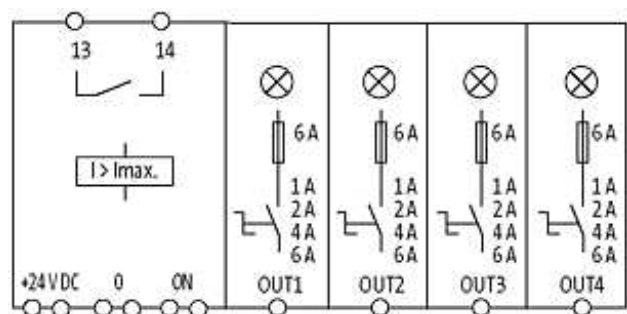

stay connected

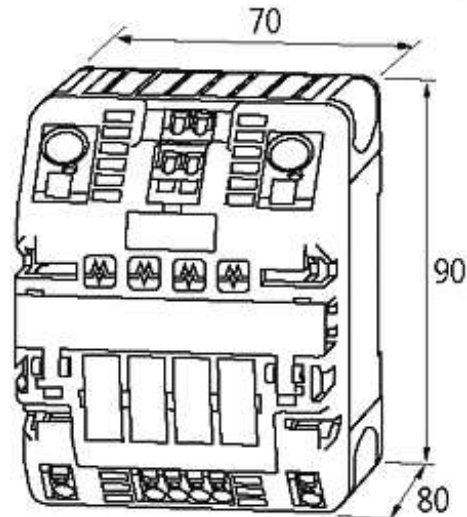

Product may differ from Image

### Approvals



### General data

Connection	Spring clamp terminals
Input terminals	2 × 16 mm <sup>2</sup>
Output terminals	per output 1 × 4 mm <sup>2</sup>
Alarm terminals	2.5 mm <sup>2</sup>
Bridging concept	two sides, with spring clamp terminals or bridge set (max. 40 A)
Mounting method	DIN-rail mountable TH35 (EN 60715)
Temperature range	0...+55 °C (storage temperature -40...+80 °C)

### Technical Data

Operating voltage	24 V DC (18...30 V DC)
Current adjustment	1 A, 2 A, 4 A, 6 A, by countersunk rotary switch, sealed
Inrush capacity	max. 20 mF (per channel)
Group alarm output	potential free 30 V AC/DC, 100 mA
Remote start (ON)	10...30 V DC
Impulse length	min. 20 ms

### Commercial data

country of origin	CZ
customs tariff number	85363010
minimum order quantity	1