



**EN** Operating instructions. . . . .pages 1 to 8  
Translation of the original operating instructions

**Content**

**1 About this document**

1.1 Function . . . . . 1

1.2 Target group: authorised qualified personnel. . . . . 1

1.3 Explanation of the symbols used . . . . . 1

1.4 Appropriate use . . . . . 1

1.5 General safety instructions . . . . . 1

1.6 Warning about misuse . . . . . 2

1.7 Exclusion of liability . . . . . 2

**2 Product description**

2.1 Ordering code . . . . . 2

2.2 Special versions. . . . . 2

2.3 Destination and use . . . . . 2

2.4 Technical data . . . . . 2

2.5 Safety classification . . . . . 3

2.6 Derating curve . . . . . 3

**3 Mounting**

3.1 General mounting instructions . . . . . 3

3.2 Dimensions . . . . . 3

**4 Electrical connection**

4.1 General information for electrical connection. . . . . 3

**5 Operating principle and settings**

5.1 LED functions. . . . . 3

5.2 Description of the terminals . . . . . 4

5.3 Notes . . . . . 5

5.4 Setting report . . . . . 5

**6 Set-up and maintenance**

6.1 Functional testing. . . . . 5

6.2 Maintenance . . . . . 5

**7 Disassembly and disposal**

7.1 Disassembly. . . . . 5

7.2 Disposal . . . . . 5

**8 Appendix**

8.1 Wiring examples . . . . . 5

8.2 Start configuration . . . . . 6

8.3 Sensor configuration . . . . . 6

8.4 Actuator configuration . . . . . 7

**9 Declaration of conformity**

9.1 EC Declaration of conformity . . . . . 8

**1. About this document**

**1.1 Function**

This operating instructions manual provides all the information you need for the mounting, set-up and commissioning to ensure the safe operation and disassembly of the safety-monitoring module. The operating instructions must be available in a legible condition and a complete version in the vicinity of the device.

**1.2 Target group: authorised qualified personnel**

All operations described in this operating instructions manual must be carried out by trained specialist personnel, authorised by the plant operator only.

Please make sure that you have read and understood these operating instructions and that you know all applicable legislations regarding occupational safety and accident prevention prior to installation and putting the component into operation.

The machine builder must carefully select the harmonised standards to be complied with as well as other technical specifications for the selection, mounting and integration of the components.

**1.3 Explanation of the symbols used**



**Information, hint, note:**

This symbol is used for identifying useful additional information.



**Caution:** Failure to comply with this warning notice could lead to failures or malfunctions.

**Warning:** Failure to comply with this warning notice could lead to physical injury and/or damage to the machine.

**1.4 Appropriate use**

The products described in these operating instructions are developed to execute safety-related functions as part of an entire plant or machine. It is the responsibility of the manufacturer of a machine or plant to ensure the correct functionality of the entire machinery or plant.

The safety-monitoring module must be exclusively used in accordance with the versions listed below or for the applications authorised by the manufacturer. Detailed information regarding the range of applications can be found in the chapter "Product description".

**1.5 General safety instructions**

The user must observe the safety instructions in this operating instructions manual, the country-specific installation standards as well as all prevailing safety regulations and accident prevention rules.



Further technical information can be found in the Schmersal catalogues or in the online catalogue on the Internet: [www.schmersal.net](http://www.schmersal.net).

The information contained in this operating instructions manual is provided without liability and is subject to technical modifications.



The entire concept of the control system, in which the safety component is integrated, must be validated to EN ISO 13849-2.

There are no residual risks, provided that the safety instructions as well as the instructions regarding mounting, commissioning, operation and maintenance are observed.

### 1.6 Warning about misuse



In case of inadequate or improper use or manipulations of the component, personal hazards or damage to machinery or plant components cannot be excluded. The relevant requirements of the standards EN 1088 and EN ISO 13850 must be observed.

### 1.7 Exclusion of liability

We shall accept no liability for damages and malfunctions resulting from defective mounting or failure to comply with this operating instructions manual. The manufacturer shall accept no liability for damages resulting from the use of unauthorised spare parts or accessories.

For safety reasons, invasive work on the device as well as arbitrary repairs, conversions and modifications to the device are strictly forbidden; the manufacturer shall accept no liability for damages resulting from such invasive work, arbitrary repairs, conversions and/or modifications to the device.

The safety-monitoring module must only be used when the enclosure is closed, i.e. with the front cover fitted.

## 2. Product description

### 2.1 Ordering code

This operating instructions manual applies to the following types:

#### SRB 211LT<sup>①</sup>

No.	Option	Description
①	/CC /PC	plug-in screw terminals 0.25...2.5 mm <sup>2</sup> plug-in cage clamps 0.25 ... 1.5 mm <sup>2</sup> screw terminals 0.25...2.5 mm <sup>2</sup>



Only if the information described in this operating instructions manual are realised correctly, the safety function and therefore the compliance with the Machinery Directive is maintained.

### 2.2 Special versions

For special versions, which are not listed in the order code below 2.1, these specifications apply accordingly, provided that they correspond to the standard version.

### 2.3 Destination and use

The safety-monitoring modules for integration in safety circuits are designed for fitting in control cabinets. They are used for the safe evaluation of the signals of positive break position switches for safety functions or magnetic safety sensors on sliding, hinged and removable safety guards as well as emergency stop control devices and AOPD's (safety light barriers).

The safety function is defined as the opening of the enabling circuits 13-14 and 23-24 and the delayed opening of the enabling circuits 37-38 when the inputs S11-S12 and/or S21-S22 are opened. The safety-relevant current paths with the outputs contacts 13-14 and 23-24 meet the following requirements under observation of a PFH value assessment (also refer to chapter 2.5 "Safety classification"):

- Control category 4 – PL e to DIN EN ISO 13849-1
- corresponds to SIL 3 to DIN EN 61508-2
- SILCL 3 to DIN EN 62061

The safety-relevant current paths with the outputs contacts 37-38 meet the following requirements under observation of a PFH value assessment (also refer to chapter 2.5 "Safety classification"):

- Control category 3 – PL d to DIN EN ISO 13849-1
- corresponds to SIL 2 to DIN EN 61508-2
- SILCL 2 to DIN EN 62061

To determine the Performance Level (PL) of the entire safety function (e.g. sensor, logic, actuator) to DIN EN ISO 13849-1, an analysis of all relevant components is required.

### 2.4 Technical data

#### General data:

Standards:	IEC/EN 60204-1, EN 60947-5-1, EN ISO 13849-1, IEC/EN 61508
Climate resistance:	EN 60068-2-78
Mounting:	Snaps onto standard DIN rail to EN 60715
Terminal designations:	EN 60947-1
Material of the housings:	Plastic, glass-fibre reinforced thermoplastic, ventilated
Material of the contacts:	AgSnO, AgNi, self-cleaning, positive drive
Weight:	230 g
Start conditions:	Automatic or start button (monitored)
Feedback circuit available:	yes
Pull-in delay for automatic start:	typ. 120 ms, max. 130 ms
Pull-in delay with reset button:	typ. 10 ms, max. 15 ms
Drop-out delay in case of emergency stop:	typ. 15 ms, max. 20 ms
Drop-out delay on "supply failure":	≤ 55 ms

#### Mechanical data:

Connection type:	refer to 2.1 Ordering code
Cable section:	refer to 2.1 Ordering code
Connecting cable:	rigid or flexible
Tightening torque for the terminals:	0.6 Nm
With removable terminals:	refer to 2.1 Ordering code
Mechanical life:	10 million operations
Resistance to shock:	10 g / 11 ms
Resistance to vibrations to EN 60068-2-6:	10 ... 55 Hz, amplitude 0.35 mm
Ambient temperature:	-25 °C ... +60 °C
Storage and transport temperature:	-40 °C ... +85 °C
Protection class:	Enclosure: IP40 Terminals: IP20 Clearance: IP54
Air clearances and creepage distances to IEC/EN 60664-1:	4 kV/2 (basic insulation)
EMC rating:	to EMC Directive

#### Electrical data:

Contact resistance in new state:	max. 100 mΩ
Power consumption:	2.4 W / 5.9 VA, plus signalling output
Rated operating voltage U <sub>e</sub> :	24 VDC: -15% / +20%, residual ripple max. 10% 24 VAC: -15% / +10%
Frequency range:	50 / 60 Hz
Fuse rating for the operating voltage:	Internal electronic trip, tripping current F1: > 750 mA; tripping current F2: > 75 mA; Reset after disconnection of supply voltage; tripping current F3: > 140 mA

#### Current and voltage at the control circuits:

- S11, S12, S21, S22:	24 VDC, 10 mA
- X1, X2:	24 VDC, start impulse 25 mA / 25 ms
- X1, X3:	24 VDC, start impulse 950 mA / 10 ms

#### Monitored inputs:

Cross-wire detection:	optional
Wire breakage detection:	yes
Earth connection detection:	yes
Number of NO contacts:	0
Number of NC contacts:	2
Cable length:	1-channel without cross-wire short detection: - 1,500 m = 1.5 mm <sup>2</sup> - 2,500 m = 2.5 mm <sup>2</sup>
Conduction resistance:	max. 40 Ω

#### Outputs:

Number of safety contacts:	3
Number of auxiliary contacts:	0
Number of signalling outputs:	1

Switching capacity of the safety contacts  
(please observe derating curve Section 2.6):

- 13-14, 23-24 (STOP 0):	max. 250 VAC, 8 A ohmic (inductive in case of appropriate protective wiring); min. 5 V / 5 mA,
- 37-38 (STOP 1):	max. 250 V, 6 A ohmic (inductive in case of appropriate protective wiring); min. 10 V / 10 mA

Switching capacity of the signalling outputs: Y1: 24 VDC / 100 mA

Fuse rating of the safety contacts:	8 A slow blow
- 13-14, 23-24 (STOP 0):	8 A slow blow
- 37-38 (STOP 1):	6.3 A slow blow
Fuse rating of the signalling output:	Y1: 100 mA (internal electronic trip F4)

Utilisation category to EN 60947-5-1:

- 13-14, 23-24, (STOP 0):	AC-15: 230 VAC / 6 A, DC-13: 24 VDC / 5 A;
- 37-38, (STOP 1):	AC-15: 230 VAC / 3 A, DC-13: 24 VDC / 2 A

Dimensions H x W x D:	SRB 211LT/PC: 100 x 22.5 x 121 mm
	SRB 211LT: 120 x 22.5 x 121 mm
	SRB 211LT/CC: 130 x 22.5 x 121 mm

The data specified in this manual are applicable when the component is operated with rated operating voltage  $U_e \pm 0\%$ .

### 2.5 Safety classification

Standards:	EN ISO 13849-1, IEC 61508, EN 60947-5-1
PL:	STOP 0: up to e, STOP 1: up to d
Category:	STOP 0: up to 4, STOP 1: up to 3
PFH value:	STOP 0: $\leq 2.0 \times 10^{-8}/h$ , STOP 1: $\leq 2.0 \times 10^{-7}/h$
DC:	STOP 0: 99% (high), STOP 1: > 60% (low)
CCF:	> 65 points
SIL:	STOP 0: up to 3, STOP 1: up to 2
Service life:	20 years

The PFH values of  $2.0 \times 10^{-8}/h$  and  $2.0 \times 10^{-7}/h$  applies to the combinations of contact load (current through enabling contacts) and number of switching cycles ( $n_{oply}$ ) mentioned in the table below. At 365 operating days per year and a 24-hours operation, this results in the below-mentioned switching cycle times ( $t_{cycle}$ ) for the relay contacts. Diverging applications upon request.

Contact load	$n_{oply}$	$t_{cycle}$
20 %	525,600	1.0 min
40 %	210,240	2.5 min
60 %	75,087	7.0 min
80 %	30,918	17.0 min
100 %	12,223	43.0 min

### 2.6 Derating curve

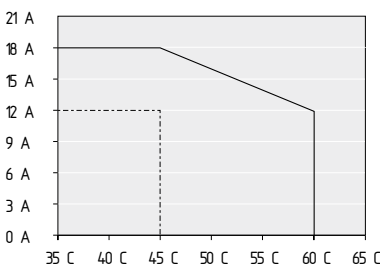

Fig. 1:  
vertical = residual current;  
horizontal = ambient temperature;  
continuous line: operating voltage/thermal test current DC;  
dashed line: operating voltage/thermal test current AC.

Mounting distance to other safety-monitoring modules as of a residual current > 6 A: at least 10 mm

Derating curve depending on the rated operating voltage  $U_e$  of the SRB safety-monitoring module.

## 3. Mounting

### 3.1 General mounting instructions

Mounting: snaps onto standard DIN rails to EN 60715.

Snap the bottom of the enclosure slightly tilted forwards in the DIN rail and push up until it latches in position.

### 3.2 Dimensions

All measurements in mm.

Device dimensions (H/W/D):

SRB 211LT/PC:	100 x 22.5 x 121 mm
SRB 211LT:	120 x 22.5 x 121 mm
SRB 211LT/CC:	130 x 22.5 x 121 mm

## 4. Electrical connection

### 4.1 General information for electrical connection



As far as the electrical safety is concerned, the protection against unintentional contact of the connected and therefore electrically interconnected apparatus and the insulation of the feed cables must be designed for the highest voltage, which can occur in the device.



The electrical connection may only be carried out by authorised personnel in a de-energised condition.

Wiring examples: see appendix



To avoid EMC disturbances, the physical ambient and operational conditions at the place where the product is installed, must meet the provisions laid down in the paragraph "Electromagnetic Compatibility (EMC)" of DIN EN 60204-1.

## 5. Operating principle and settings

### 5.1 LED functions

- K1: Status channel 1
- K2: Status channel 2
- K3: Status delayed enabling circuit channel 1
- K4: Status delayed enabling circuit channel 2
- $U_B$ : Status operating voltage (LED is on, when the operating voltage on the terminals A1-A2 is ON)
- $U_i$ : Status internal operating voltage (LED is on, when the operating voltage on the terminals A1-A2 is ON and the fuse has not been triggered).

### 5.2 Description of the terminals (see Fig. 2)

Voltages:	A1	+24 VDC/24 VAC
	A2	0 VDC/24 VAC
Inputs:	S11-S12	Input channel 1 (+)
	S12-S22	Input channel 2 (+)
	S21-S22	Input channel 2 (-) (with cross-wire short detection)
Outputs:	13-14	First safety enabling circuit (stop 0)
	23-24	Second safety enabling circuit (STOP 0)
	37-38	Third safety enabling circuit (stop 1)
Start:	X1-X2	Feedback circuit and external reset (monitored)
	X1-X3	Automatic start
	Y1	Status enabling paths

### Opening the front cover (see Fig. 3)

- To open the front cover, insert a slotted screwdriver in the top and bottom cover notch and gently lift it.
- When the front cover is open, the electrostatic discharge requirements must be respected and observed.
- After setting, the front cover must be fitted back in position.
- The set drop-out delay must be entered on the front cover.



Only touch the components after electrical discharge!

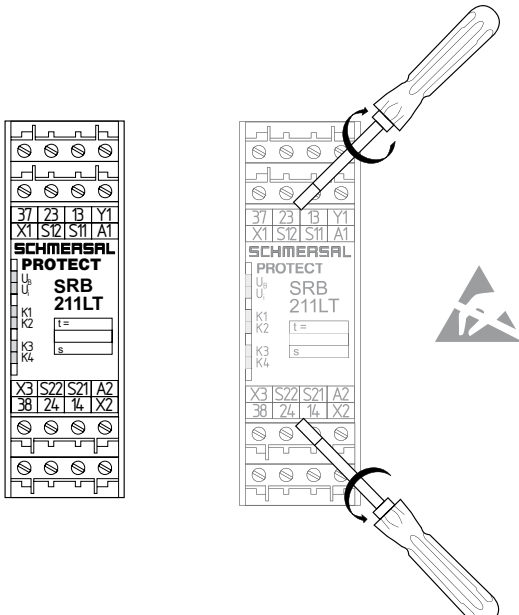

Fig. 2

Fig. 3

### Time setting (see Fig. 4 and 5)



#### DIP switch settings:

- The DIP switches are located underneath the front cover of the safety-monitoring module (see Fig. 3).
- Both DIP switches SW 1 (channel 1) and SW 2 (channel 2) must be set identically.
- The DIP switches can be set when the operating voltage is on; however, in order for the setting to be saved in the SRB 211LT, the voltage supply must be interrupted for approx. 3 seconds.
- The set drop-out delay must be checked and entered on the front cover and in the settings report.

DIP switch setting	Drop-out delay	DIP switch setting	Drop-out delay
	< 0.1 s		60 s
	17 s		100 s
	22 s		120 s
	28 s		180 s
	35 s		220 s
	40 s		240 s
	45 s		300 s
	55 s		480 s

Fig. 4 Tolerance of the drop-out delay  $\pm 2\%$

### Setting the switch (see Fig. 5)

- The cross-wire short monitoring function (factory setting) is programmed by means of switch S1 underneath the front cover of the safety-monitoring module.

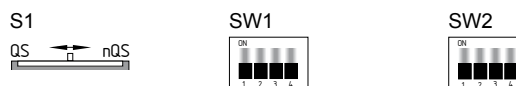

Fig. 5



The switch must only be operated in de-energised condition by means of a finger or an insulated blunt tool.

### Resetting the hybrid fuse

- The hybrid fuse of the safety-monitoring module can be reset by switching the operating voltage off and back on.

5.3 Notes

Delayed enabling circuits (see Fig. 6)

- The drop-out delay of the safety enabling circuits 37-38 can be set within the range of 0...480 seconds by means of DIP switches. The DIP switches are located underneath the front cover of the safety-monitoring module.
- The safety enabling circuit 37-38 meets STOP category 1 to EN 60204-1.
- The drop-out delays of the safety enabling circuits STOP 1 can be reduced in case of a failure.

Signalling output Y1 (see Fig. 7)

- The safety relays K1, K2 are signalled through signalling output Y1.

K1	K2	Y1
On	On	low (0 V)
On	Off	low (0 V)
Off	On	low (0 V)
Off	Off	high (+ 24 V)

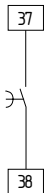

Fig. 6

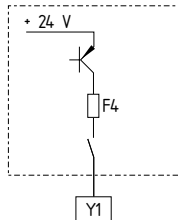

Fig. 7

5.4 Setting report

This report regarding the setting of the device must be completed accordingly by the customer and enclosed in the technical manual of the machine.

The setting report must be available whenever a safety check is performed.  
Company: \_\_\_\_\_

The safety-monitoring module is used in the following machine:

Machine n° \_\_\_\_\_ Machine type \_\_\_\_\_ Module n° \_\_\_\_\_

Set drop-out delay: \_\_\_\_\_

Set on (date) \_\_\_\_\_ Signature of the responsible person \_\_\_\_\_

6. Set-up and maintenance

6.1 Functional testing

The safety function of the safety-monitoring module must be tested.

The following conditions must be previously checked and met:

1. Correct fixing
2. Check the integrity of the cable entry and connections
3. Check the safety-monitoring module's enclosure for damage.
4. Check the electrical function of the connected sensors and their influence on the safety-monitoring module and the downstream actuators

6.2 Maintenance

A regular visual inspection and functional test, including the following steps, is recommended:

1. Check the correct fixing of the safety-monitoring module
2. Check the cable for damages
3. Check electrical function



The device has to be integrated into the periodic check-ups according to the Ordinance on Industrial Safety and Health, however at least 1 × year.

Damaged or defective components must be replaced.

7. Disassembly and disposal

7.1 Disassembly

The safety-monitoring module must be disassembled in a de-energised condition only. Push up the bottom of the enclosure and hang out slightly tilted forwards.

7.2 Disposal

The safety-monitoring module must be disposed of in an appropriate manner in accordance with the national prescriptions and legislations.

8. Appendix

8.1 Wiring examples

Dual-channel control, shown for a guard door monitor; with two contacts A and B, where at least one is a positive break contact; with external reset button (R) (see Fig. 8)

- Relay outputs: Suitable for 2-channel control, for increase in capacity or number of contacts by means of contactors or relays with positive-guided contacts.
- The control system recognises wire-breakage, earth faults and cross-wire shorts in the monitoring circuit.

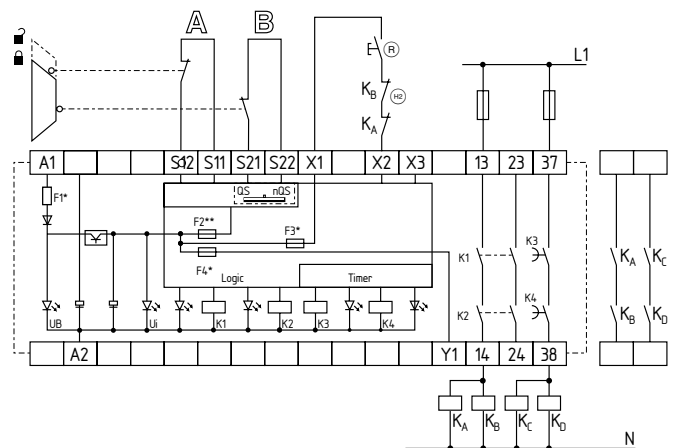

Fig. 8:

- Ⓡ = Feedback circuit;
- \* = Internal electronic fuse;
- \*\* = Hybrid fuse

8.2 Start configuration

External reset button (with edge detection) (see Fig. 9)

- The external reset button is integrated as shown.
- The safety-monitoring module is activated by the reset (after release) of the reset button (= detection of the trailing edge). Faults in the reset button, e.g. welded contacts or manipulations which could lead to an inadvertent restart, are detected in this configuration and will result in an inhibition of the operation.

Automatic start (see Fig. 10)

- The automatic start is programmed by connecting the feedback circuit to the terminals. If the feedback circuit is not required, establish a bridge.
- **Caution:** Not admitted without additional measure due to the risk of gaining access by stepping behind!
- **Caution:** within the meaning of EN IEC 60204-1 paragraph 9.2.5.4.2 and 10.8.3, the operating mode "automatic start" is only restrictedly admissible. Insbesondere ist ein unabsichtlicher Maschinen-Wiederanlauf durch andere geeignete Maßnahmen zu verhindern.

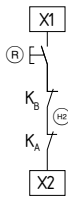

Fig. 9

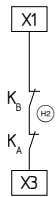

Fig. 10

8.3 Sensor configuration

Dual-channel control of a safety-related electronic (micro-processor-based) safety guard with p-type transistor outputs e.g. AOPD's to EN IEC 61496 (see Fig. 11)

- Wire breakage and earth leakage in the control circuits are detected.
- The safety-monitoring module therefore is not equipped with a cross-wire short detection here. The safety-monitoring module therefore is not equipped with a cross-wire short detection here. The function without cross-wire short monitoring is programmed by means of the switch (switch position = nQS) underneath the front cover.
- Without cross-wire short detection in the control circuits, control category 4 - PL e to DIN EN ISO 13849-1 can be achieved (with protected cable routing).
- If cross-wire shorts in the control circuits are detected by the safety guard: control category 4 – PL e to DIN EN ISO 13849-1 possible.

Single-channel emergency stop circuit with command devices to DIN EN ISO 13850 (EN 418) and EN 60947-5-5 (Fig. 12)

- Wire breakage and earth leakage in the control circuits are detected.
- The function without cross-wire short monitoring is programmed by means of the switch (switch position = nQS) underneath the front cover.

Control category 1 – PL c to DIN EN ISO 13849-1 possible, when tested to DIN EN ISO 13849-1, paragraph 6.5.2.

Dual-channel emergency stop circuit with command devices to DIN EN ISO 13850 (EN 418) and EN 60947-5-5 (Fig. 13)

- Wire breakage and earth leakage in the control circuits are detected.
- Cross-wire shorts between the control circuits are not detected.
- The function without cross-wire short monitoring is programmed by means of the switch (switch position = nQS) underneath the front cover.
- Control category 4 – PL e to DIN EN ISO 13849-1 possible (with protective wiring)

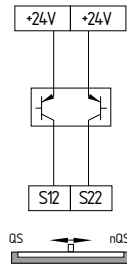

Fig. 11

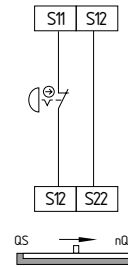

Fig. 12

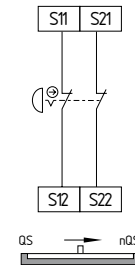

Fig. 13

Dual-channel emergency stop circuit with command devices to DIN EN ISO 13850 (EN 418) and EN 60947-5-5 (Fig. 14)

- Wire breakage and earth leakage in the control circuits are detected.
- Cross-wire shorts between the control circuits are detected.
- The cross-wire short monitoring function is programmed by means of the switch (switch position = QS) underneath the front cover.
- Category 4 – PL e to DIN EN ISO 13849-1 possible.

Single-channel guard door monitoring circuit with interlocking devices to EN 1088 (Fig. 15)

- At least one contact with positive break required.
- Wire breakage and earth leakage in the control circuits are detected.
- The function without cross-wire short monitoring is programmed by means of the switch (switch position = nQS) underneath the front cover.

Control category 1 – PL c to DIN EN ISO 13849-1 possible, when tested to DIN EN ISO 13849-1, paragraph 6.5.2.

Dual-channel guard door monitoring circuit with interlocking device to EN 1088 (Fig. 16)

- With at least one positive-break position switch
- Wire breakage and earth leakage in the control circuits are detected.
- Cross-wire shorts between the control circuits are not detected.
- The function without cross-wire short monitoring is programmed by means of the switch (switch position = nQS) underneath the front cover.
- Control category 4 – PL e to DIN EN ISO 13849-1 possible (with protective wiring)

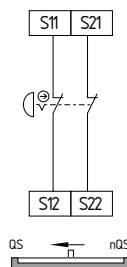

Fig. 14

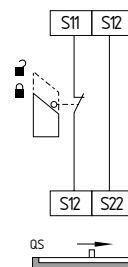

Fig. 15

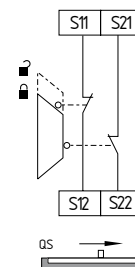

Fig. 16

**Dual-channel guard door monitoring circuit with interlocking device to EN 1088 (Fig. 17)**

- With at least one positive-break position switch
- Wire breakage and earth leakage in the control circuits are detected.
- Cross-wire shorts between the control circuits are detected.
- The cross-wire short monitoring function is programmed by means of the switch (switch position = QS) underneath the front cover.
- Category 4 – PL e to DIN EN ISO 13849-1 possible.

**Dual-channel control of magnetic safety switches to EN 60947-5-3 (see Fig. 18)**

- Wire breakage and earth leakage in the control circuits are detected.
- Cross-wire shorts between the monitoring circuits are not detected.
- The function without cross-wire short monitoring is programmed by means of the switch (switch position = nQS) underneath the front cover.
- Category 3 – PL e to DIN EN ISO 13849-1 possible.

**Dual-channel control of magnetic safety switches to EN 60947-5-3 (see Fig. 19)**

- Wire breakage and earth leakage in the control circuits are detected.
- Cross-wire shorts between the monitoring circuits are detected.
- The cross-wire short monitoring function is programmed by means of the switch (switch position = QS) underneath the front cover.
- Category 3 – PL e to DIN EN ISO 13849-1 possible.

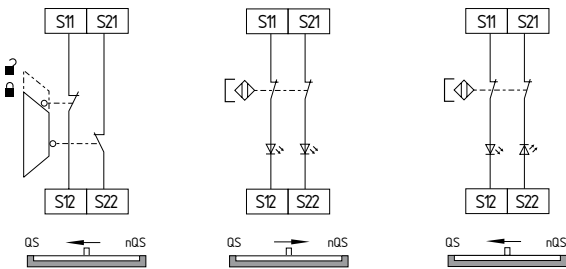

Fig. 17

Fig. 18

Fig. 19



The connection of magnetic safety switches to the SRB 211 safety-monitoring module is only admitted when the requirements of the standard EN 60947-5-3 are observed.

As the technical data are regarded, the following minimum requirements must be met:

- switching capacity: min. 240 mW
- switching voltage: min. 24 VDC
- switching current: min. 10 mA



For example, the following safety sensors meet the requirements:

- BNS33-02z-2187, BNS33-02zG-2187
- BNS260-02z, BNS260-02zG
- BNS260-02-01z, BNS260-02-01zG



Caution! When sensors with LED are wired in the control circuit (protective circuit), the following rated operating voltage must be observed and respected:

- 24 VDC with a max. tolerance of  $-5\%/+20\%$
- 24 VAC with a max. tolerance of  $-5\%/+10\%$

Otherwise availability problems could occur, especially in series-wired sensors, where a voltage drop in the control circuit is triggered by LED's for instance

**8.4 Actuator configuration**

**Single-channel control with feedback circuit (Fig. 20)**

- Suitable for increase in capacity or number of contacts by means of contactors or relays with positive-guided contacts.
- $\text{Ⓜ}$  = feedback circuit:  
If the feedback circuit is not required, establish a bridge.

**Dual-channel control with feedback circuit (Fig. 21)**

- Suitable for increase in capacity or number of contacts by means of contactors or relays with positive-guided contacts.
- $\text{Ⓜ}$  = feedback circuit:  
If the feedback circuit is not required, establish a bridge.

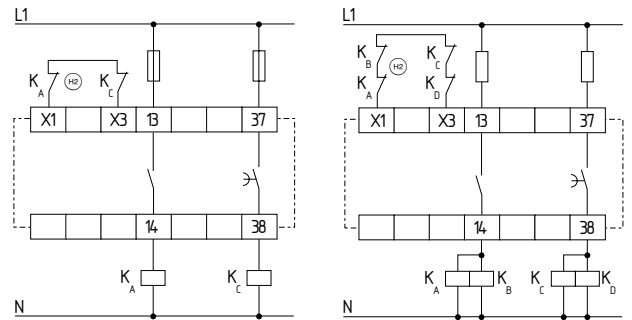

Fig. 20

Fig. 21

**Differential control with feedback circuit (see Fig. 22)**

- Suitable for increase in capacity or number of contacts by means of contactors or relays with positive-guided contacts.
- $\text{Ⓜ}$  = feedback circuit:  
If the feedback circuit is not required, establish a bridge.

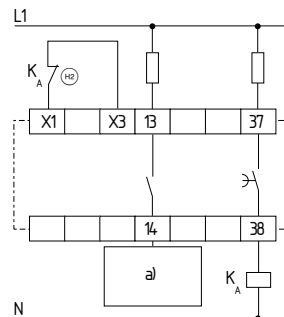

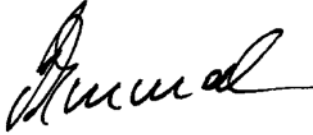

Fig. 22

a) Enabling signal controller

9. Declaration of conformity

9.1 EC Declaration of conformity

	
<h2>EC Declaration of conformity</h2>	
Translation of the original Declaration of Conformity	K.A. Schmersal GmbH & Co. KG Industrielle Sicherheitssysteme Möddinghofe 30, 42279 Wuppertal Germany Internet: www.schmersal.com
<p>We hereby certify that the hereafter described safety components both in its basic design and construction conform to the applicable European Directives.</p>	
<b>Name of the safety component:</b>	SRB 211LT; SRB 211LT/CC; SRB 211LT/PC
<b>Description of the safety component:</b>	Safety-monitoring module for emergency stop circuits, guard door monitoring, magnetic safety switches and AOPD's
<b>Relevant EC-Directives:</b>	2006/42/EC-EC-Machinery Directive 2004/108/EC EMC-Directive
<b>Person authorized for the compilation of the technical documentation:</b>	Oliver Wacker Möddinghofe 30 42279 Wuppertal
<b>Notified body, which approved the full quality assurance system, referred to in Appendix X, 2006/42/EC:</b>	TÜV Rheinland Industrie Service GmbH Alboinstraße 56 12103 Berlin ID n°: 0035
<b>Place and date of issue:</b>	Wuppertal, September 5, 2013
SRB211 LT-C-EN	
	Authorised signature <b>Philip Schmersal</b> Managing Director



The currently valid declaration of conformity can be downloaded from the internet at [www.schmersal.net](http://www.schmersal.net).



**K. A. Schmersal GmbH & Co. KG**  
**Industrielle Sicherheitssysteme**  
Möddinghofe 30, D - 42279 Wuppertal  
Postfach 24 02 63, D - 42232 Wuppertal

Phone: +49 - (0)2 02 - 64 74 - 0  
Telefax +49 - (0)2 02 - 64 74 - 1 00  
E-Mail: [info@schmersal.com](mailto:info@schmersal.com)  
Internet: <http://www.schmersal.com>