



**EN** Operating instructions. . . . .pages 1 to 8  
Translation of the original operating instructions

**Content**

<b>1 About this document</b>	
1.1 Function . . . . .	1
1.2 Target group: authorised qualified personnel. . . . .	1
1.3 Explanation of the symbols used . . . . .	1
1.4 Appropriate use . . . . .	1
1.5 General safety instructions . . . . .	1
1.6 Warning about misuse . . . . .	2
1.7 Exclusion of liability . . . . .	2
<b>2 Product description</b>	
2.1 Ordering code . . . . .	2
2.2 Special versions. . . . .	2
2.3 Destination and use . . . . .	2
2.4 Technical data . . . . .	2
2.5 Safety classification . . . . .	3
<b>3 Mounting</b>	
3.1 General mounting instructions . . . . .	3
3.2 Dimensions . . . . .	3
<b>4 Electrical connection</b>	
4.1 General information for electrical connection. . . . .	3
<b>5 Operating principle and settings</b>	
5.1 LED functions. . . . .	3
5.2 Description of the terminals . . . . .	3
5.3 Notes . . . . .	4
<b>6 Set-up and maintenance</b>	
6.1 Functional testing. . . . .	4
6.2 Maintenance . . . . .	4
<b>7 Disassembly and disposal</b>	
7.1 Disassembly. . . . .	4
7.2 Disposal . . . . .	4
<b>8 Appendix</b>	
8.1 Wiring example . . . . .	4
8.2 Sensor configuration . . . . .	5
8.3 Actuator configuration . . . . .	6
<b>9 Declaration of conformity</b>	
9.1 EC Declaration of conformity . . . . .	7

**1. About this document**

**1.1 Function**

This operating instructions manual provides all the information you need for the mounting, set-up and commissioning to ensure the safe operation and disassembly of the safety switchgear. The operating instructions must be available in a legible condition and a complete version in the vicinity of the device.

**1.2 Target group: authorised qualified personnel**

All operations described in this operating instructions manual must be carried out by trained specialist personnel, authorised by the plant operator only.

Please make sure that you have read and understood these operating instructions and that you know all applicable legislations regarding occupational safety and accident prevention prior to installation and putting the component into operation.

The machine builder must carefully select the harmonised standards to be complied with as well as other technical specifications for the selection, mounting and integration of the components.

**1.3 Explanation of the symbols used**



**Information, hint, note:**

This symbol is used for identifying useful additional information.



**Caution:** Failure to comply with this warning notice could lead to failures or malfunctions.

**Warning:** Failure to comply with this warning notice could lead to physical injury and/or damage to the machine.

**1.4 Appropriate use**

The products described in these operating instructions are developed to execute safety-related functions as part of an entire plant or machine. It is the responsibility of the manufacturer of a machine or plant to ensure the correct functionality of the entire machinery or plant.

The safety switchgear must be exclusively used in accordance with the versions listed below or for the applications authorised by the manufacturer. Detailed information regarding the range of applications can be found in the chapter "Product description".



To avoid EMC disturbances, the physical ambient and operational conditions at the place where the product is installed, must meet the provisions laid down in the paragraph "Electromagnetic Compatibility (EMC)" of DIN EN 60204-1.

**1.5 General safety instructions**

The user must observe the safety instructions in this operating instructions manual, the country-specific installation standards as well as all prevailing safety regulations and accident prevention rules.



Further technical information can be found in the Schmersal catalogues or in the online catalogue on the Internet: [www.schmersal.net](http://www.schmersal.net).

The information contained in this operating instructions manual is provided without liability and is subject to technical modifications.



If multiple safety components are wired in series, the Performance Level to EN ISO 13849-1 will be reduced due to the restricted error detection under certain circumstances. The entire concept of the control system, in which the safety component is integrated, must be validated to EN ISO 13849-2.

There are no residual risks, provided that the safety instructions as well as the instructions regarding mounting, commissioning, operation and maintenance are observed.

### 1.6 Warning about misuse



In case of inadequate or improper use or manipulations of the safety switchgear, personal hazards or damages to machinery or plant components cannot be excluded. The relevant requirements of the standards EN 1088 and EN ISO 13850 must be observed.

### 1.7 Exclusion of liability

We shall accept no liability for damages and malfunctions resulting from defective mounting or failure to comply with this operating instructions manual. The manufacturer shall accept no liability for damages resulting from the use of unauthorised spare parts or accessories.

For safety reasons, invasive work on the device as well as arbitrary repairs, conversions and modifications to the device are strictly forbidden; the manufacturer shall accept no liability for damages resulting from such invasive work, arbitrary repairs, conversions and/or modifications to the device.

The input expander module PROTECT-PE-02 / ...-PE-02-SK must only be used when the enclosure is closed, i.e. with the front cover fitted.

## 2. Product description

### 2.1 Ordering code

This operating instructions manual applies to the following types:

#### PROTECT-PE-①-②

No.	Option	Description
①	02	Connection of NC/NC sensors
	11	Connection of NC/NO sensors
	11-AN	Connection of NC/NO sensors outputs with antivalent enabling contacts with cage clamps
②	SK	with plug-in screw connection



- Possibility to connect up to 4 sensors per interface, e.g. safety magnetic switches of the BNS type, emergency stop control devices, interlocking devices, etc.
- Wiring of up to 4 sensors per interface with signals connected to the potential possible, e.g. CSS type electronic safety sensors and AOPD's (only PROTECT-PE-02)
- Current and voltage limitation of the input circuits
- Cross-wire monitoring of the input circuits
- Signalling output for each sensor (monitoring of both circuits of the sensors)
- Signalling output summation signal of all sensors and one summation signal signalling contact (NC + NO)
- Green LED indications for U, and every sensor contact
- Cascading possible for the connection of up to 80 sensors



This device is designed as input expander module. The safety function is only realised in conjunction with the downstream basic device (SRB). To this effect, the device must be connected in accordance with the wiring example!



Only if the information described in this operating instructions manual are realised correctly, the safety function and therefore the compliance with the Machinery Directive is maintained.

### 2.2 Special versions

For special versions, which are not listed in the order code below 2.1, these specifications apply accordingly, provided that they correspond to the standard version.

### 2.3 Destination and use

The input expander modules for integration in safety circuits are designed for fitting in control cabinets. They are used for the evaluation of the signals of 1...4 sensors and the summarised transmission of the signals to a downstream safety-monitoring module.

The function is defined as the opening of the enabling contacts 13-14 and 23-24 (in variant AN the opening of 13-14 and the closing of 21-22) when one or more of the 8 sensor inputs are actuated. The enabling paths with the outputs contacts 13-14 and 23-24 (21-22) meet the following requirements under observation of a PFH value assessment and in conjunction with an SRB (control category 4 / PLe) (also refer to chapter 2.5 "Safety classification"):

- Control category 3 – PL d to EN ISO 13849-1 (when multiple safety guards are opened within one work cycle)
- SIL 2 to IEC 61508
- SILCL 2 to EN 62061

refer to folder:

[http://www.schmersal.net/Bilddata/broschue/k-info/i\\_diap01.pdf](http://www.schmersal.net/Bilddata/broschue/k-info/i_diap01.pdf)

(german)

[http://www.schmersal.net/Bilddata/broschue/k-info/i\\_diap02.pdf](http://www.schmersal.net/Bilddata/broschue/k-info/i_diap02.pdf)

(english)



The above-described requirements cannot be met by the input expander module solely, but only in combination with a safety-monitoring module as described in this manual.

To determine the Performance Level (PL) to EN ISO 13849-1 of the entire safety function (e.g. sensor, logic, actuator), an assessment of all relevant components is required.

### 2.4 Technical data

#### General data:

Standards:	IEC/EN 60204-1, EN 60947-5-1; EN ISO 13849-1, IEC 61508
Climate resistance:	EN 60068-2-78
Mounting:	snaps onto standard DIN rail to EN 60715
Terminal designations:	EN 60947-1
Material of the housings:	Plastic, thermoplastic
Material of the contacts:	AgSnO
Weight:	160 g
Start conditions:	Automatic
Feedback circuit (Y/N):	No
Pull-in delay:	≤ 10 ms
Drop-out delay in case of "emergency stop":	≤ 10 ms
Drop-out delay on "supply failure":	≤ 60 ms

#### Mechanical data:

Connection type:	Cage clamps;
- SK variant:	plug-in screw connection
Cable section:	
- Cage clamps:	min. 0.08 mm <sup>2</sup> / max. 2.5 mm <sup>2</sup>
- Screw connection:	min. 0.14 mm <sup>2</sup> / max. 1.5 mm <sup>2</sup>
Connecting cable:	rigid or flexible
Tightening torque for the terminals:	0.6 Nm
With removable terminals (Y/N):	SK variant: Yes
Mechanical life:	10 million operations
Electrical life:	Derating curve available on request
Resistance to shock:	30 g / 11 ms
Resistance to vibrations to EN 60068-2-6:	10 ... 55 Hz, amplitude 0.35 mm

#### Ambient conditions:

Ambient temperature:	-25 °C ... +55 °C
Storage and transport temperature:	-40 °C ... +85 °C
Protection class:	IP20
Air clearances and creepage distances to IEC/EN 60664-1:	800 V/2 (basic insulation)
EMC rating:	to EMC Directive

### Electrical data:

Contact resistance in new state:	max. 100 mΩ
Power consumption:	max. max. 1.7 W plus Y1-Y5
Rated operating voltage $U_e$ :	24 VDC -12%/+20%, residual ripple max. 10%
Fuse rating for the operating voltage:	Internal electronic trip, tripping current > 300 mA

### Monitored inputs:

Cross-wire detection (Y/N):	Yes
Wire breakage detection (Y/N):	Yes
Earth leakage detection (Y/N):	Yes
Number of NO contacts:	variant 11: 4
Number of NC contacts:	variant 02: 8; variant 11: 4
Conduction resistance:	max. 40 Ω
Current and voltage limitation of the control contacts:	24 VDC / 10 mA

### Outputs:

Number of enabling paths:	2
Number of auxiliary contacts:	1 change-over contact
Number of signalling outputs:	5
Switching capacity of the enabling paths:	13-14; 23-24, 21-22: max. 24 V, 2 A ohmic (inductive with suitable protective circuit); min. 10 V / 10 mA
Recommended fuse for the enabling paths:	2 A slow blow
Switching capacity of the signalling outputs:	Y1 ... Y5: 24 VDC / 100 mA
Fuse rating of the signalling output:	internal electronic trip, tripping current > 500 mA
Switching capacity of the signalling outputs:	32-33, 33-34: 24 VDC / 2 A
Fuse rating of the signalling outputs:	2 A slow blow
Dimensions H × W × D:	126 mm × 65.5 mm × 61 mm

The data specified in this manual are applicable when the component is operated with rated operating voltage  $U_e \pm 0\%$ .

### 2.5 Safety classification

Standards:	EN ISO 13849-1, IEC 61508
PL:	STOP 0: up to d
Category:	STOP 0: up to 3
DC:	STOP 0: > 60 % (low)
CCF:	> 65 points
PFH value:	STOP 0: $2.00 \times 10^{-7}/h$
SIL:	STOP 0: up to 2
Service life:	20 years

The PFH value of  $2.00 \times 10^{-7}/h$  applies to the combinations of contact load (current through enabling contacts) and number of switching cycles ( $n_{oply}$ ) mentioned in the table below.

At 365 operating days per year and a 24-hours operation, this results in the below-mentioned switching cycle times ( $t_{cycle}$ ) for the relay contacts.

### Diverging applications upon request.

Contact load	$n_{oply}$	$t_{cycle}$
20 %	525,600	1.0 min
40 %	210,240	2.5 min
60 %	75,087	7.0 min
80 %	30,918	17.0 min
100 %	12,223	43.0 min

## 3. Mounting

### 3.1 General mounting instructions

Mounting: snaps onto standard DIN rails to EN 60715.

Snap the bottom of the enclosure slightly tilted backwards in the DIN rail and push down until it latches in position.

### 3.2 Dimensions

All measurements in mm.

Device dimensions (H/W/D): 126 mm × 65.5 mm × 61 mm  
with plug-in terminals: 126 mm × 65.5 mm × 53 mm

## 4. Electrical connection

### 4.1 General information for electrical connection



As far as the electrical safety is concerned, the protection against unintentional contact of the connected and therefore electrically interconnected apparatus and the insulation of the feed cables must be designed for the highest voltage, which can occur in the device.



The electrical connection may only be carried out by authorised personnel in a de-energised condition.

Wiring examples: see appendix

## 5. Operating principle and settings

### 5.1 LED functions

- U: Status operating voltage (LED is on, when the operating voltage is on and the internal electronic fuse has not been triggered)
- Y1...Y4: Status of the inputs S1...S8 (LED is on, when the allocated input circuit is opened)
- Y5: on, when one or more input circuit(s) is/are opened

### 5.2 Description of the terminals

Voltages:	A1	+24 VDC
	A2	0 VDC
	+	24 VDC
	-	0 VDC
	S1 ... S8	+24 VDC / 0 VDC
Outputs:	13-14	1. Enabling circuit
	23-24	2. Enabling circuit
	21-22	2. Enabling circuit at variant AN (NC)
Start:	Y1 ... Y4	Status of the inputs (+24 V, when the allocated input circuit is opened)
	Y5	+24 V, when the input circuit is opened
	32-33	NC contact "input circuit" opened
	33-34	NO contact "input circuit" opened



Signalling outputs must not be used in safety circuits.

### 5.3 Notes

PROTECT-PE-02

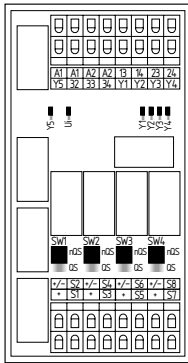

Fig. 1: front view

PROTECT-PE-11

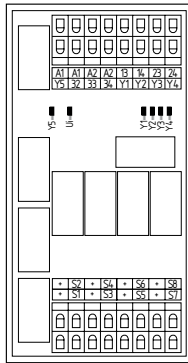

Fig. 2: front view

PROTECT-PE-11-AN

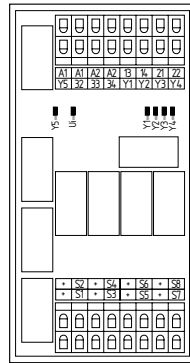

Fig. 3: front view

### Cross-wire short monitoring function can be deactivated (only PROTECT-PE-02/-SK)

#### Opening the front cover:

- To set the switch, the front cover must be removed by unscrewing the 4 fixing screws.



Only touch the components after electrical discharge!



After setting, the front cover must be imperatively fitted back in position.

#### Setting the switch:

- The cross-wire short monitoring function (factory setting) is programmed by means of the switches SW1 ... SW4.
- Allocation of the switches to the inputs: SW1 / S2, SW2 / S4, SW3 / S6, SW4 / S8
- Pos. nQS (top) (see Fig. 4): not cross-wire short proof, suitable for 1-channel applications and applications with outputs connected to the positive potential in the control circuits.
- Pos. QS (below) (see Fig. 5): cross-wire short proof, suitable for 2-channel applications without outputs connected to the potential in the control circuits and applications with outputs connected to the positive and negative potential in the control circuits.



The switch must only be operated in de-energised condition by means of a finger or an insulated blunt tool.



The electrostatic discharge requirements must be respected and observed.

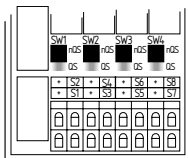

Fig. 4



Fig. 5

## 6. Set-up and maintenance

### 6.1 Functional testing

The function of the component must be tested. The following conditions must be previously checked and met:

- Correct fixing
- Check the integrity of the cable entry and connections
- Check the switch enclosure for damage
- Check the electrical function of the connected sensor technology and their influence on the safety-monitoring module and the downstream actuators

### 6.2 Maintenance

A regular visual inspection and functional test, including the following steps, is recommended:

- Check the correct fixing of the input expander module
- Check the cable for damages
- Check electrical function



The device has to be integrated into the periodic check-ups according to the Ordinance on Industrial Safety and Health, however at least 1 × year.

**Damaged or defective components must be replaced.**

## 7. Disassembly and disposal

### 7.1 Disassembly



The input expander module must be disassembled in the de-energised condition only.

Insert a screwdriver at the marked position (see Fig. 6), press in the direction of the cover and remove.

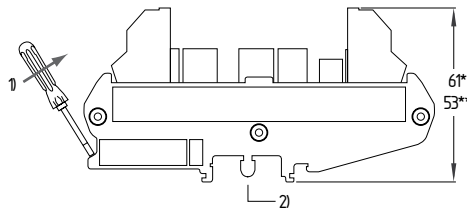

Fig. 6:

- Disassembly;
- DIN rail system to EN 60715;

\* with cage clamps;

\*\* with plug-in terminals (representation of the standard version PROTECT-PE-11)

### 7.2 Disposal

The safety monitoring module must be disposed of in an appropriate manner in accordance with the national prescriptions and legislations.

## 8. Appendix

### 8.1 Wiring example

- Start level: Depends on the wiring of the safety relay module
- Sensor level: 2-channel control of magnetic safety switches according to IEC 60947-5-3
- Output level: dual-channel control of a downstream safety-monitoring module

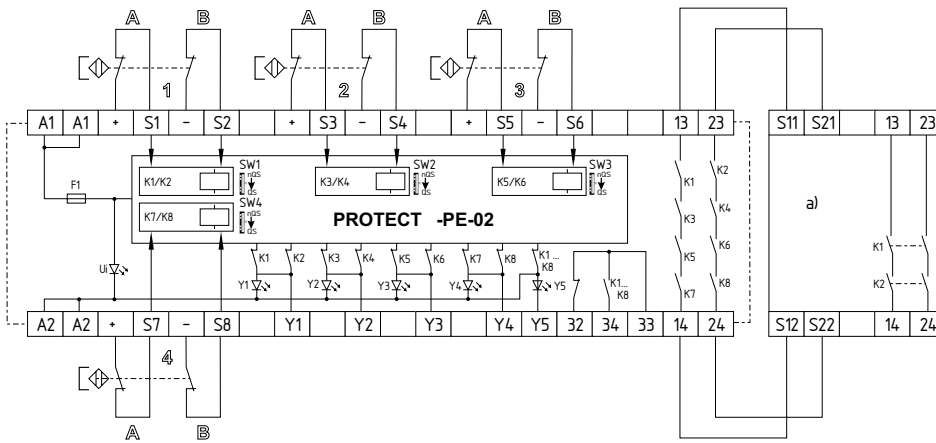

Fig. 7: a) Safety-monitoring module, e.g. SRB 301MC, SRB 301ST, SRB 211ST

8.2 Sensor configuration

Dual-channel control with cross-wire short detection (see Fig. 8 to 10 only PROTECT-PE 02)

- The control system recognises wire-breakage and earth faults in the control circuit.
- Cross-wire shorts between the monitoring circuits are detected.
- If the inputs S1, S3, S5 and S7 are not used, they have to be bridged to +.
- If the inputs S2, S4, S6 and S8 are not used, they have to be bridged to -.

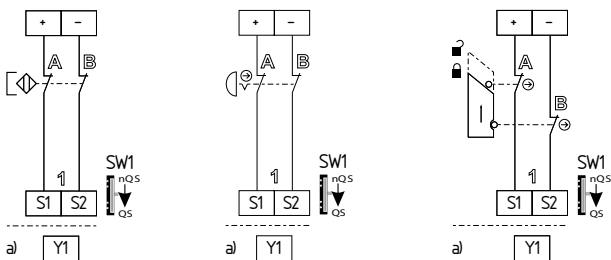

Fig. 8: Magnetic safety switch to IEC 60947-5-3; a) Signalling outputs  
 Fig. 9: Emergency stop circuit to EN ISO 13850 and EN 60947-5-5; a) Signalling outputs  
 Fig. 10: Guard door monitoring to EN 1088; a) Signalling outputs

Dual-channel control without cross-wire short detection (see Fig. 11 to 13 only PROTECT-PE 02)

- The control system recognises wire-breakage and earth faults in the control circuit.
- Cross-wire shorts between the monitoring circuits are not detected.
- If the inputs S1 ... S8 are not used, they have to be bridged to +.

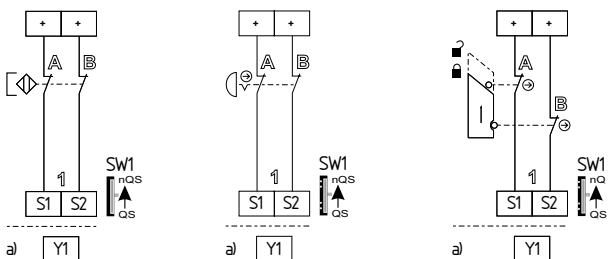

Fig. 11: Magnetic safety switch to IEC 60947-5-3; a) Signalling outputs  
 Fig. 12: Emergency stop circuit to EN ISO 13850 and EN 60947-5-5; a) signal outputs  
 Fig. 13: Guard door monitoring to EN 1088; a) Signalling outputs

Dual-channel control of a safety-related electronic (microprocessor-based) safety guard with p-type transistor outputs e.g. AOPD's to EN 61496-1 (see Fig. 14 only PROTECT-PE 02)

- The control system recognises wire-breakage and earth faults in the control circuit.
- Cross-wire shorts between the monitoring circuits are not detected.
- The safety-monitoring module therefore is not equipped with a cross-wire short detection here.
- If the inputs S1 ... S8 are not used, they have to be bridged to +.

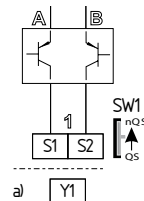

Fig. 14: a) Signalling outputs

Dual-channel antivalent control (see Fig. 15 to 17 only PROTECT-PE 11)

- The control system recognises wire-breakage and earth faults in the control circuit.
- Cross-wire shorts between the monitoring circuits are detected by the downstream safety-monitoring module.
- If the inputs S1, S3, S5 and S7 are not used, they have to be bridged to +.
- The unused inputs S2, S4, S6 and S8 remain vacant.

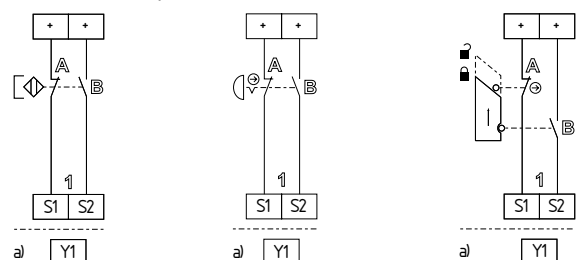

Fig. 15: Magnetic safety switch to IEC 60947-5-3; a) Signalling outputs  
 Fig. 16: Emergency stop circuit to EN ISO 13850 and EN 60947-5-5; a) Signalling outputs  
 Fig. 17: Guard door monitoring to EN 1088; a) Signalling outputs

### 8.3 Actuator configuration

#### Enabling circuits (Fig. 18 and 19)

All safety-monitoring modules with control category 4 or PLe from the Schmersal Group with current < 1 A in the monitoring circuit can be connected to the Protect-PE-02 and Protect-PE-11 devices.

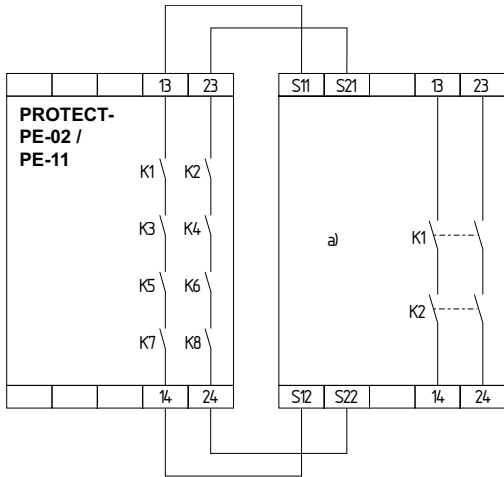

Fig. 18: PROTECT-PE-02 / PROTECT-PE-11  
a) Safety-monitoring module, e.g. SRB 301MC, SRB 301ST, SRB 211ST, ...

- All safety-monitoring modules from the Schmersal Group, which are suitable for setting up an antivalent input circuit, can be connected to the PROTECT-PE-11-AN.

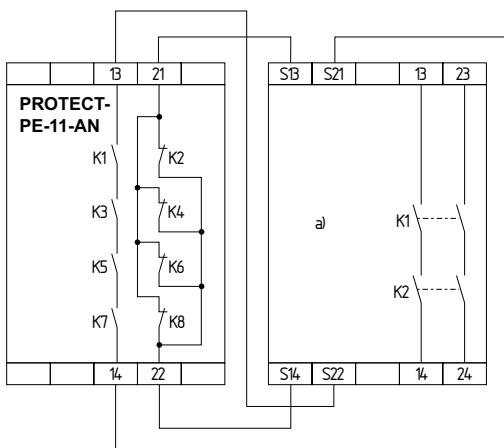



Fig. 19: PROTECT-PE-11-AN  
a) Safety-monitoring module, e.g. SRB 301AN, SRB 211AN, AES 1337, ...

 The safety-monitoring modules must be suitable for the signal processing of 1- or 2-channel potential-free NC contacts or, for the version PROTECT-PE-11-AN, for a combination of NC/NO contacts. The start and actuator configuration must be realised in accordance with this operating instructions manual.

#### Signalling outputs (see fig. 20 and 21)

- The LED's or the signal outputs indicate that the safety guard or the emergency stop circuit is opened.
- Both contact circuits of a sensor are monitored.
- If the safety guard or the emergency stop circuit is opened, a 24V signal is activated at the output concerned (Y1...Y4) and Y5 (summation signal) and the allocated LED's are lit.
- If one or more safety guards or emergency stop circuits are opened, the signalling contact 33-34 is closed and the signalling contact 32-33 is opened.

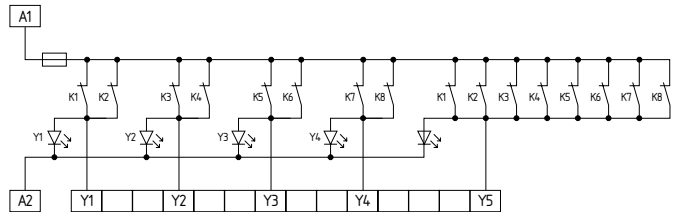

Fig. 20

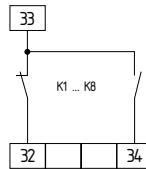



Fig. 21

 Auxiliary contacts must not be used in safety circuits.

#### Cascading (Fig. 22 and 23)

- In this way, up to 20 components can be wired in series. This corresponds to a signal processing of up to 80 sensors.

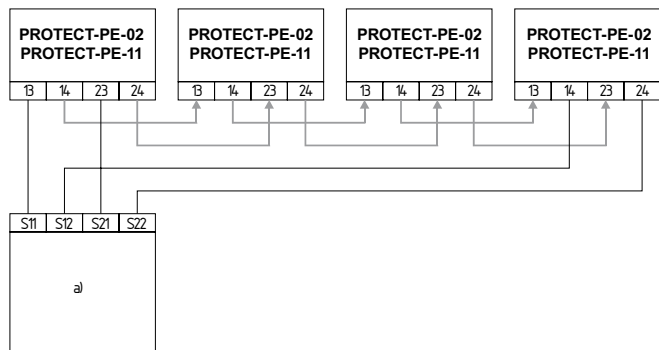

Fig. 22: a) Safety-monitoring module, e.g. SRB 301MC, SRB 301ST, SRB 211ST, ...

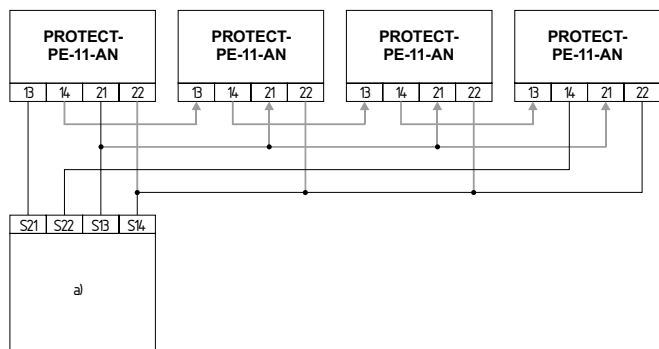

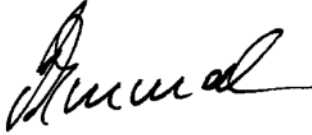

Fig. 23: a) Safety-monitoring module, e.g. SRB 301AN, SRB 211AN, ...

9. Declaration of conformity

9.1 EC Declaration of conformity

	
<h2>EC Declaration of conformity</h2>	
Translation of the original Declaration of Conformity	K.A. Schmersal GmbH & Co. KG Industrielle Sicherheitssysteme Mödinghofe 30, 42279 Wuppertal Germany Internet: www.schmersal.com
We hereby certify that the hereafter described safety components both in its basic design and construction conform to the applicable European Directives.	
<b>Name of the safety component:</b>	PROTECT-PE
<b>Description of the safety component:</b>	Safety-monitoring module as input expander in conjunction with a safety-monitoring module as basic device
<b>Relevant EC-Directives:</b>	2006/42/EC-EC-Machinery Directive 2004/108/EC EMC-Directive
<b>Person authorized for the compilation of the technical documentation:</b>	Ulrich Loss Mödinghofe 30 42279 Wuppertal
<b>Notified body, which approved the full quality assurance system, referred to in Appendix X, 2006/42/EC:</b>	TÜV Rheinland Industrie Service GmbH Alboinstraße 56 12103 Berlin ID n°: 0035
<b>Place and date of issue:</b>	Wettenberg, April 21, 2010
PROTECT PE-BEN	
	Authorised signature <b>Philip Schmersal</b> Managing Director



The currently valid declaration of conformity can be downloaded from the internet at [www.schmersal.net](http://www.schmersal.net).





**K. A. Schmersal GmbH & Co. KG**  
**Industrielle Sicherheitssysteme**  
Möddinghofe 30, D - 42279 Wuppertal  
Postfach 24 02 63, D - 42232 Wuppertal

Phone: +49 - (0)2 02 - 64 74 - 0  
Telefax +49 - (0)2 02 - 64 74 - 1 00  
E-Mail: [info@schmersal.com](mailto:info@schmersal.com)  
Internet: <http://www.schmersal.com>