



EN Operating instructions. pages 1 to 32
Original

Content

1 About this document

1.1 Function 2

1.2 Target group: authorised qualified personnel 2

1.3 Explanation of the symbols used 2

1.4 Appropriate use 2

1.5 General safety instructions 2

1.6 Warning about misuse 2

1.7 Exclusion of liability 2

2 Product description

2.1 Destination and use 3

2.2 Ordering code 3

2.3 Special versions 3

2.4 Included in delivery 3

2.5 Technical data 3

2.6 Response time (reaction time) 4

2.7 Safety classification 4

2.8 Functions 4

2.8.1 Protective mode / Automatic 5

2.8.2 Restart interlock (manual reset) 5

2.8.3 Restart interlock with double acknowledgement/reset 5

2.8.4 Blanking non-changeable objects (only SLC445) 6

2.8.5 Blanking non-changeable objects with moveable edges (only SLC445) 6

2.8.6 Blanking changeable objects (only SLC445) 6

2.8.7 Blanking changeable objects (only SLG445) 7

2.8.8 Contactor control EDM (Parameter P4) 7

2.8.9 Multiple sampling (Parameter P8) 8

2.8.10 Turn display through 180 degrees (Parameter P7) 8

2.8.11 Alternative beam coding 8

2.9 Self-test 8

2.10 Parameter setting 9

3 Bridging function / muting

3.1 Muting configuration 11

3.1.1 Muting with two sensors in parallel arrangement 11

3.1.2 Muting with two sensors in crossed arrangement (F2) 12

3.1.3 Muting with four sensors in parallel arrangement (F3) 13

3.1.4 Special muting applications 14

3.2 Muting parameters 14

3.2.1 Muting cycle time (parameter L1) 15

3.2.2 Time limited monitoring of the switching signals of muting sensors (Parameter L2) 15

3.2.3 Monitoring the switching order from muting sensors (Parameter L3) 15

3.2.4 Reducing the bridging time with muting-end via the AOPD (Parameter L4) 15

3.2.5 Bridging of object gaps (Parameter L5) 16

3.2.6 Muting-end delay (Parameter L6) 16

3.2.7 Muting-start delay (Parameter L7) 16

3.2.8 Limiting the bridged protection area range (Parameter L8) 16

3.2.9 Belt-stop signal (Parameter P4 = 2) 17

3.2.10 Muting release via machine signal (Parameter P4 = 3) 17

3.3 Manual bridging function (Override) 17

3.4 Muting sensors (Parameter F5) 17

3.5 Muting signals and status message 18

4 Cyclic operation

4.1 Betriebsarten 18

5 Mounting

5.1 General conditions 19

5.2 Protection field and approach 19

5.3 Alignment of the sensors 19

5.4 Setting mode 20

5.5 Safety distance 21

5.5.1 Minimum distance to reflecting surfaces 22

5.6 Dimensions 22

5.6.1 Dimensions transmitter and receiver SLC445 22

5.6.2 Dimensions transmitter and receiver SLG445 23

5.7 Fixing 23

5.7.1 Included in delivery 23

5.7.2 Optional accessories 24

6 Electrical connection

6.1 Wiring example Muting 26

6.2 Wiring example cyclic function 27

6.3 Connector configuration Receiver, Transmitter & Cable 28

6.3.1 Muting operation 28

6.3.2 Cyclic operation 28

6.4 Wiring example with safety-monitor module 29

7 Set-up and maintenance

7.1 Check before start-up 29

7.2 Maintenance 29

7.3 Regular check 29

7.4 Half-yearly inspection 29

7.5 Cleaning 29

8 Diagnostic

8.1 Status information LED 30

8.2 Fault diagnostic 31

9 Disassembly and disposal

9.1 Disassembly 31

9.2 Disposal 31

10 Appendix

10.1 Contact 31

11 EU Declaration of conformity

1. About this document

1.1 Function

This operating instructions manual provides all the information you need for the mounting, set-up and commissioning to ensure the safe operation and disassembly of the safety switchgear. The operating instructions must be available in a legible condition and a complete version in the vicinity of the device.

1.2 Target group: authorised qualified personnel

All operations described in this operating instructions manual must be carried out by trained specialist personnel, authorised by the plant operator only.

Please make sure that you have read and understood these operating instructions and that you know all applicable legislations regarding occupational safety and accident prevention prior to installation and putting the component into operation.

The machine builder must carefully select the harmonised standards to be complied with as well as other technical specifications for the selection, mounting and integration of the components.

1.3 Explanation of the symbols used



Information, hint, note:

This symbol is used for identifying useful additional information.



Caution: Failure to comply with this warning notice could lead to failures or malfunctions.

Warning: Failure to comply with this warning notice could lead to physical injury and/or damage to the machine.

1.4 Appropriate use

The products described in these operating instructions are developed to execute safety-related functions as part of an entire plant or machine. It is the responsibility of the manufacturer of a machine or plant to ensure the correct functionality of the entire machine or plant.

The safety switchgear must be exclusively used in accordance with the versions listed below or for the applications authorised by the manufacturer. Detailed information regarding the range of applications can be found in the chapter "Product description".

1.5 General safety instructions

The user must observe the safety instructions in this operating instructions manual, the country-specific installation standards as well as all prevailing safety regulations and accident prevention rules.



Further technical information can be found in the Schmersal catalogues or in the online catalogue on the Internet: www.schmersal.net.

The information contained in this operating instructions manual is provided without liability and is subject to technical modifications.



The entire concept of the control system, in which the safety component is integrated, must be validated to EN ISO 13849-2.

There are no residual risks, provided that the safety instructions as well as the instructions regarding mounting, commissioning, operation and maintenance are observed.

Additional measures could be required to ensure that the system does not present a dangerous breakdown, when other forms of light beams are available in a special application (e.g. use of wireless control devices on cranes, radiation of welding sparks or effects of stroboscopic lights).

1.6 Warning about misuse



In case of improper use or manipulation of the safety switchgear, personal hazards or damages to machinery or plant components cannot be excluded when safety switchgear is used. The relevant requirements of the standards EN ISO 13855 and EN ISO 13857 must be observed.



Only if the configuration described in this operating instructions manual are realised correctly is the safety function and therefore the compliance with the Machinery Directive is maintained.

1.7 Exclusion of liability

We shall accept no liability for damages and malfunctions resulting from defective mounting or failure to comply with this operating instructions manual. The manufacturer shall accept no liability for damages resulting from the use of unauthorised spare parts or accessories.

For safety reasons, invasive work on the device as well as arbitrary repairs, conversions and modifications to the device are strictly forbidden; the manufacturer shall accept no liability for damages resulting from such invasive work, arbitrary repairs, conversions and/or modifications to the device.

2. Product description

2.1 Destination and use

The SLC/SLG445 is a non-contact, self-testing safety guard (AOPD), which is used for the protection of hazardous points, hazardous areas and machine accesses. If one or more light beams are interrupted, the hazardous movement must be stopped.



The user must evaluate and design the safety chain in accordance with the relevant standards and the required safety level.

2.2 Ordering code

This operating instructions manual applies to the following types:

SLC445-ER-①-②-01

No.	Option	Description
①	xxxx	Protection field heights in mm available lengths: 0170, 0250, 0330, 0410, 0490, 0570, 0650, 0730, 0810, 0890, 0970, 1050, 1130, 1210, 1290, 1370, 1450, 1530*, 1610*, 1690*, 1770*
②	14	Resolution 14 mm with a range of 0.3 m ... 7 m
	30	Resolution 30 mm with a range of 0.3 m ... 10 m

-01 = Integrated status indication

* only for resolution 30 mm

SLG445-ER-①-②

No.	Option	Description
①	0500-02	Distance between outermost beams: 500 mm, 2-beam
	0800-03	800 mm, 3-beam
	0900-04	900 mm, 4-beam
②	01	Integrated status indication, range 0.3 ... 12 m
	H1	Integrated status indication, range 3 ... 20 m

2.3 Special versions

For special versions, which are not listed in the order code, these specifications apply accordingly, provided that they correspond to the standard version.

2.4 Included in delivery

- Sensors E, R (receiver with integrated status lamp)
- Mounting kit MS-1100
- Operating instructions DE/EN

2.5 Technical data

Standards:	EN 61496-1; CLC/TS 61496-2; EN ISO 13849; EN 62061
Material of the enclosure:	Aluminium
protection zone heights:	
- SLC445:	Resolution 14 mm: 170 ... 1450 mm, Resolution 30 mm: 170 ... 1770 mm;
- SLG445:	500 mm, 800 mm, 900 mm
Detection ability for test bodies:	
- SLC445:	14 mm, 30 mm;
- SLG445:	2 beams with resolution 500 mm 3 beams with resolution 400 mm 4 beams with resolution 300 mm

Range of the protection zone:

- SLC445:	14 mm: 0.3 ... 7.0 m, 30 mm: 0.3 ... 10.0 m;
- SLG445:	-01: 0.3 ... 12.0 m, -H1: 3.0 ... 20.0 m

Response time:

- beam coding (standard)	1 - 48 L = 10 ms, 49 - 144 L = 20 ms,
- with alternative beam coding	1 - 48 L = 15 ms, 49 - 144 L = 27 ms

Rated operating voltage: 24 VDC ±10% (PELV) supply unit
 I_{max} : 2.0 A, to EN 60204 (power drop ≤ 20 ms)

Rated operating current: 250 mA max. + 2 x 0.25 A each OSSD

Wavelength of the infrared radiation:

880 nm

Transmitter, infrared emitted radiation

- to DIN EN 12198-1:	Category 0
- to DIN EN 62471:	free group

Safety outputs

OSSD1, OSSD2: 2 x short-circuit proof PNP semi-conductor outputs

Test impulse cycle OSSD: 750 ms

Test impulse length: 100 µs

Switching voltage HIGH ¹⁾: 15 ... 26.4 V

Switching voltage LOW ¹⁾: 0 ... 2 V

Switching current each OSSD: 0 ... 250 mA

Leakage current ²⁾: 1 mA

Load capacity: 0 ... 2.2 µF

Load inductance ³⁾: 0 ... 2H

Admissible conduction resistance between OSSD and load: 2.5 Ω

Admissible conduction resistance of the supply cable: 1.5 Ω

Muting lamp output

Input voltage: 24 VDC

Switching current: max. 250mA

Release inputs S1/S2, D_IN, MSG 1, MSG 2

Input voltage HIGH (inactive): 11 ... 30 V

Input voltage LOW (active): 0 ... 2.0 V

Input current HIGH: 3 ... 10 mA

Input current LOW: 0 ... 2 mA

Functions: Automatic operation, restart inhibit, double confirmation, contactor control, object blanking (non-changeable position and changeable position), alternative beam coding, muting, cycle, multiple sampling

Signal times

Contactor control: max. 500 ms

Restart interlock (manual reset): 50 ms ... 1.5 s, signal transmission in case of trailing edge

LED indications transmitter: transmitting, status

LED indications receiver: OSSD ON, OSSD OFF, restart, signal reception, blanking, information

Connection: M12 connector plug with metal thread, receiver 12-pole, transmitter 4-pole

Ambient temperature: -25° C ... +50° C;
at -25° C: Reduction of range by -10%

Storage temperature: -25° C ... +70° C

Status display: Diagnostics and function setting

Protection class: IP67 (IEC 60529)

Resistance to vibration: 10 ... 55 Hz to IEC 60068-2-6

Resistance to shock: 10 g, 16 ms, to IEC 60028-2-29

Year of construction: as of 2014 version 1.0

¹⁾ To IEC 61131-2

²⁾ In case of failure, the leakage current flows to the OSSD cable. The downstream control element must recognise this state as LOW. A safety PLC must detect this state.

³⁾ The load inductivity generates an induced voltage during the switch-off, which compromises the downstream components (spark quenching element).

2.6 Response time (reaction time)

The response time depends on the height of the protection field, the resolution, the number of light beams and the beam coding.

SLC445 Resolution 14 mm				
Protection field height [mm]	Beams (Lines) [Number]	Response time		Weight [kg]
		Standard beam coding [ms]	Alternative beam coding [ms]	
170	16	10	15	0.4
250	24	10	15	0.5
330	32	10	15	0.6
410	40	10	15	0.8
490	48	10	15	0.9
570	56	20	27	1.0
650	64	20	27	1.1
730	72	20	27	1.2
810	80	20	27	1.4
890	88	20	27	1.5
970	96	20	27	1.6
1050	104	20	27	1.7
1130	112	20	27	1.8
1210	120	20	27	2.0
1290	128	20	27	2.1
1370	136	20	27	2.2
1450	144	20	27	2.3

SLC445 Resolution 30 mm				
Protection field height [mm]	Beams (Lines) [Number]	Response time		Weight [kg]
		Standard beam coding [ms]	Alternative beam coding [ms]	
170	8	10	15	0.4
250	12	10	15	0.5
330	16	10	15	0.6
410	20	10	15	0.8
490	24	10	15	0.9
570	28	10	15	1.0
650	32	10	15	1.1
730	36	10	15	1.2
810	40	10	15	1.4
890	44	10	15	1.5
970	48	10	15	1.6
1050	52	20	27	1.7
1130	56	20	27	1.8
1210	60	20	27	2.0
1290	64	20	27	2.1
1370	68	20	27	2.2
1450	72	20	27	2.3
1530	76	20	27	2.4
1610	80	20	27	2.6
1690	84	20	27	2.7
1770	88	20	27	2.8

SLG445				
Beams [Number]	Beam distance [mm]	Response time		Weight [kg]
		Standard beam coding [ms]	Alternative beam coding [ms]	
2	500	10	15	0.8
3	400	10	15	1.3
4	300	10	15	1.4



The response time of the AOPD doubles if the multiple sampling is activated. Perform a new calculation for the safety distance and adjust the safety distance to match your calculation.

2.7 Safety classification

Standards:	EN ISO 13849-1, EN 62061
PL:	up to e
Control category:	up to 4
PFH value:	$5.14 \times 10^{-9} / h$
SIL:	up to 3
Service life:	20 years

2.8 Functions

The system consists of a receiver and a transmitter. No additional safety monitoring modules are required for the functions described.

The diagnostic and function selection takes place with a command device (key release), refer to the chapter on parameterisation.

The system has the following functions:

- Protective mode automatic (automatic start after release of the protection zone)
- Restart Interlock (manual reset)
- Double acknowledgement/reset
- Contactor control (EDM)
- Alternative beam coding
- Blanking non-movable objects
- Blanking non-changeable objects with movable edges
- Blanking changeable objects
- Multiple sampling
- Muting
- Cyclic operation

Factory setting

The system offers a variety of functions without an evaluation unit.

The following table gives an overview of the possible functions and the factory settings configuration.

Function	Factory setting	Configuration
Protective mode, automatic	not active	External wiring
Restart interlock (manual reset)	not active	External wiring
Double acknowledgement/reset	not active	with command device
Blanking objects (non-changeable and changeable)	not active	with command device
Contactor control (EDM)	not active	with command device
Alternative beam coding	not active	with command device
Multiple sampling	not active	with command device
Muting	not active	with command device
Cyclic operation	not active	with command device



No operating mode is active when in the delivery condition. The desired operating mode is set at the time of commissioning of the AOPD by setting a jumper or adjusting a parameter setting. If no operating mode is set the safety switching outputs (OSSD) are not released, the status E1 is issued and the status indication LED OSSD OFF (red) is active.

2.8.1 Protective mode / Automatic

In the automatic mode of operation the safety switching outputs (OSSD) are switched to the ON state if the protection zone is clear, this is done without any release from a command device.

Wiring of the receiver

Jumper connection pin 3 with pin 5

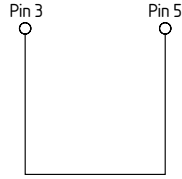

This operating mode initiates an automatic restart of the machine if the protection zone is not interrupted.



The AOPD switches to the setup mode of operation when a HI signal (+24VDC) on input pin 3 is present for at least 2 seconds when the power supply is applied, refer to chapter: Setup Mode.



This operating mode may only be chosen in conjunction with the restart interlock (manual reset) of the machine. This operating mode must not be chosen, when persons can step behind the protection field.

2.8.2 Restart interlock (manual reset)

In the operating mode Inhibit Restart, the safety switching outputs (OSSD) remain in the OFF condition after the power supply is applied or after the protection zone has been interrupted.

The AOPD first switches the OSSDs to the ON state when a signal on the input "Release" is applied from a command device (button).

Wiring of the receiver

Jumper connection pin 8 with pin 5
 Command device (pushbutton for release) at pin 3

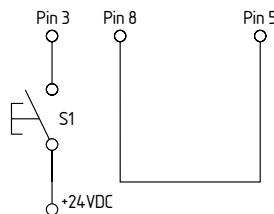

The AOPD switches to the setup mode of operation when a HI signal (+24VDC) on input pin 3 is present for at least 2 seconds when the power supply is applied, refer to chapter: Setup Mode.



The command device (button release) must be located outside the hazardous zone. The hazardous zone must be easily visible to the user.

2.8.3 Restart interlock with double acknowledgement/reset

In applications with access monitoring, a complete overview of the hazardous areas is often not possible; despite that, a reset of the command device for the restart interlock outside of the hazardous area by third parties is at all times enabled, although possible persons/operators are in the non visible area. This hazard can be secured against with the operating mode Restart interlock with double acknowledgement/reset. For this, a command device is to be located within the hazardous area and a second command device outside the hazardous area.



Wiring of the receiver

Command device S1 at pin 3
 Command device S2 at pin 8
 Pin 5, no signal (input open)

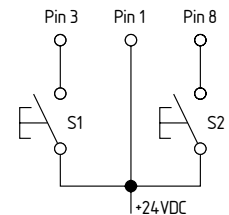

Specification

The operating mode "Restart interlock with double acknowledgement/reset", the setting P5 is activated. See chapter: Parameter setting.

Release after the following sequence

- 1) Actuate command device inside of the hazardous area (S2)
- 2) Pass through the protective field and interrupt at least one beam and release again.
- 3) Actuate the command device outside of the hazardous area (S1)

Acknowledging with S1 is possible within a timeframe of 2 to 60 seconds after pressing S2. If the order or the time requirement is not followed, the process must be repeated.

Signaling LED restart (yellow)

Status	Note
On	AOPD expects release on S2
flashing	AOPD expects release on S1



The Restart interlock with double acknowledgement/reset is not available with muting and cyclic operation.

2.8.4 Blanking non-changeable objects (only SLC445)

The AOPD can blank non-changeable objects in the protection zone. Several non-changeable objects can be blanked in the protection area.

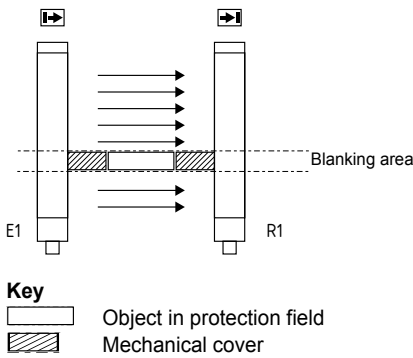

The blanking of objects in the protection area can be freely selected. The first beam line that is located immediately behind the diagnostic window, cannot be blanked.

The blanked area is monitored after the Teach-IN (P1) and is not allowed to be changed. If the blanked area does change or the object is removed from the protection area the AOPD locks in the OFF state. This lock-out can be released by a new Teach-IN.



The function is activated by means of the parameter setting (P1). An active beam blanking is shown via the LED (blanking / blue) on the diagnostic window. See chapter: Parameter setting.



- The remaining lateral areas must be protected against intrusion by means of mechanical covers.
- The lateral covers must be fixed with the object.
- Partial covers are not authorised.
- After the change, the protection zone must be tested by means of the test rod.
- The function AOPD restart interlock or the machine is to be activated.

2.8.5 Blanking non-changeable objects with moveable edges (only SLC445)

This function can compensate for the position change of a changeable object with the tolerance of a single beam. This position change corresponds to a movement of approx. 10 mm (with 14 mm resolution) and approx. 20 mm (with a 30 mm resolution) upwards and downwards in the protection zone.

Example object movement in protection zone

Beam number	3	4	5	6	7	Status OSSDs
Blanking beam 4, 5, 6	○	●	●	●	○	Teach-IN, 4-6
Shift 1 beam down	●	●	●	○	○	ok
Shift 1 beam up	○	○	●	●	●	ok
Object only covers 2 beams	○	○	●	●	○	ok
Object only covers 2 beams	○	●	●	○	○	ok
Object with downward edge displacement	●	●	●	●	○	ok
Object with upward edge displacement	○	●	●	●	●	ok
Object displacement exceeds 1 beam	○	○	○	●	●	Error
Object size changed (1 beam)	○	○	●	○	○	Error
Object size changed (5 beams)	●	●	●	●	●	Error

This function is activated with the parameter P2. See chapter: Parameter setting. A combination with changeable object blending (P1) or changeable object blending (P3) is not possible.

The effective resolution of the AOPD is different in the edge region of the blanked object. Refer to the chapter Blanking changeable objects (1 beam) for the effective resolution in edge regions.



Perform a new calculation of the safety distance with the effective resolution. Adjust the safety distance in accordance with your calculation.

2.8.6 Blanking changeable objects (only SLC445)

The AOPD can blank out changeable objects.

Up to 2 beams (changeable) can be blanked out in the protection zone, refer to parameterisation (P3). Combining with P1 is possible but not with P2.

Example Changeable and non-changeable object blanking

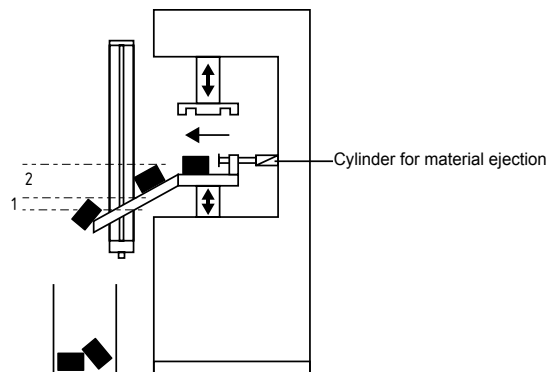

Key

- 1 = Region changeable object blanking
- 2 = Region changeable object blanking

The changeable object blanking is not bound to a position in the protection zone. The first beam immediately after the diagnostic window cannot be blanked.

This function allows a protection zone interruption without switching off the safety exits (e.g. with material movements in the protection zone, material discharge or process controlled material movement). The changeable object blanking causes a reduction in the effective resolution capacity. Depending on the number of beams, the effective resolution has to be taken into consideration for the determination of the safety distance.

In a system with a physical resolution of 14 mm and a changeable object blanking of two beams the effective resolution is reduced to 34 mm. The effective resolution is to be permanently announced and visible on an information sign to the recipient.

Effective resolution

The effective resolution in case of activated blanking can be found in the following table.

Resolution 14 mm		
Blanked beams	Physical resolution	Effective resolution
1	14	24
2	14	34

Resolution 30 mm		
Blanked beams	Physical resolution	Effective resolution
1	30	48
2	30	68



This function is activated in the parameter settings with the parameter P3. The active function is shown via the LED (blanking / blue) in the diagnostic window. See chapter: Parameter settings.



Perform a new calculation of the safety distance with the effective resolution. Adjust the safety distance in accordance with your calculation.



The Standard IEC/TS 62046 describes the measures that may be necessary to protect persons from hazards due to protected areas that are blanked.

2.8.7 Blanking changeable objects (only SLG445)

The AOPD can blank out changeable objects.

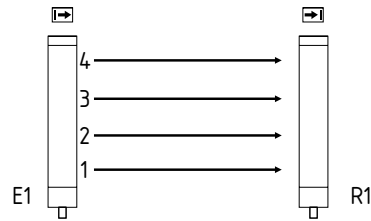

The changeable object blanking is not bound to a position in the protection zone. The first beam immediately after the diagnostic window cannot be blanked.

This function allows a protection zone interruption without switching off the safety exits (e.g. with material movements in the protection zone, material discharge or process controlled material movement).

This function is activated in the parameter settings with the parameter P3. The active function is shown via the LED (blanking / blue) in the diagnostic window. See chapter: Parameter settings.



- Changeable object blanking with the SLG445 not possible with 2 beams.
- The blanking of one beam maximum in the SLG445 3-beam version or the SLG445 4-beam version is possible, provided that the protective function is taken into account.
- The function restart interlock of the AOPD or machine is to be activated.
- The protection zone should be checked after the configuration, the protection zone must be confirmed (recognition of a person).
- The Standard IEC/TS 62046 describes the measures that may be necessary to protect persons from hazards due to protected areas that are blanked.

2.8.8 Contactor control EDM (Parameter P4)

The function protection control is for the monitoring of externally connected switching elements with positively driven feedback contacts (relays, contacts and valves).

To be able to recognise malfunctions of the switching elements such as welding of contacts or a broken contact spring, the signal change is monitored after every condition change of the safety switching outputs with a delay of maximum 500 ms.

If there are malfunctions the switching outputs are locked to the OUT state. After the malfunction has been removed, a restart should take place.



The contactor control is not activated upon delivery. This function is activated in the parameter setting with P4. The signal input D_IN is used in connection with the muting and cyclic functions and also for the monitoring of machine signals.

Connection EDM

Wiring of the receiver

Kn1, Kn2 = Auxiliary contacts
feedback loop

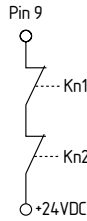

The auxiliary contacts must only be connected, when the function contact control is activated.

2.8.9 Multiple sampling (Parameter P8)

If there are temporary disturbances of the protection zone, availability can be increased by activating this function.

Examples are:

- optical disturbances by pulses of light
- due to chips and remnants flying through the protection zone
- droplets running down the AOPD



The response time of the AOPD doubles if the multiple sampling is activated. Perform a new calculation for the safety distance and adjust the safety distance to match your calculation.



The function is activated in parameter setting mode with the option P 8.

2.8.10 Turn display through 180 degrees (Parameter P7)

The orientation of the 7 segment display can be rotated through 180 degrees via the software option. This ensures that the display remains readable in rotated mounting positions of the AOPD.

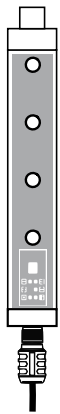

Parameter P 7 –
Display normal orientation

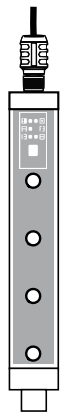

Parameter P 7 A
Display rotated

2.8.11 Alternative beam coding

If there is the possibility that a receiver receives the light signal from two emitters then one of the systems should have an alternative beam coding. In this way a mutual interference of the light beams can be eliminated.

If adjacent systems are operated without alternative beam coding, the user is at risk.

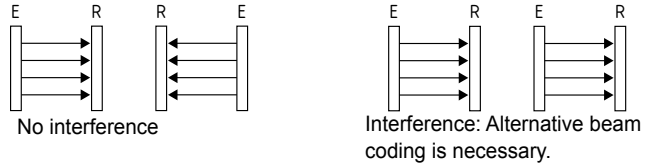

- The alternative beam coding prevents mutual interference for adjacently placed systems. Therefore one of the systems should be altered.
- The beam coding is permanently shown by the transmitter and the receiver by means of flashing LED's (refer to LED status information).
- The alternative beam coding should be set on each **Sensor** (receiver and transmitter) separately.
- The function at the receiver is activated in parameter setting mode (P 6).

Transmitter parameter setting

Wiring of the transmitter

- Jumper connection pin 1 with pin 2
- Jumper connection pin 3 with pin 4

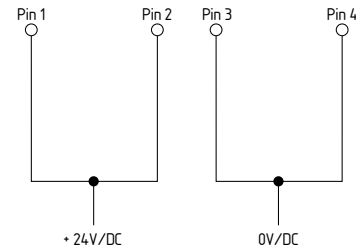

The response time of the system is increased when an alternative beam coding is used. To this end, the safety distance must be adjusted. Refer to chapter: Response time.

2.9 Self-test

The AOPD carries out a self-test within 2 seconds after the power supply is applied. In the event of a malfunction the AOPD locks to a safe operational mode and issues the status (refer to chapter: Troubleshooting). After a successful self-test the AOPD switches to the ON state if the protection zone is clear (automatic operating mode).

During operation, the system executes a cyclic self-test. Safety-relevant faults are detected within the reaction time and cause the outputs to be put in the OFF state and an error code is issued.

2.10 Parameter setting

The parameter setting allows an individual adjustment of the AOPD to the requirements of the present application.

Activating the operating mode parameter setting allows all settings to be made with the help of the 7 segment display and a button.

Procedure

The power supply must be removed by the receiver before changing the operating mode. In the non-powered state the following jumper connection and a pushbutton must be connected:

Wiring of the receiver

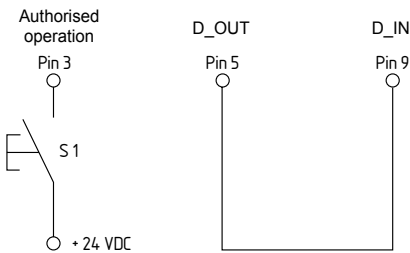

- Possible jumper connections must be removed from pin 3, pin 5, pin 9 or pin 8. If the EDM function is activated the auxiliary contact to pin 9 should be removed.
- Jumper D_OUT (pin 5) to D_IN (pin 9)
- Connection to command device S1 (+24 V) to pin 3
- After the configuration the original wiring should be restored.

Switching on the power supply causes the receiver to start in the parameter setting operating mode.

Signalling the operating state

	7-segment display
●	LED OSSD OFF (red) active
●	LED OSSD ON (green) active

Operation of the menu system

Pushbutton actions

T1	Short pushbutton press (0.1 to 1.5 sec.) to change to the next menu item.
T2	Long pushbutton press (2.5 to 6 sec.) to select a menu item or to select the next parameter value.

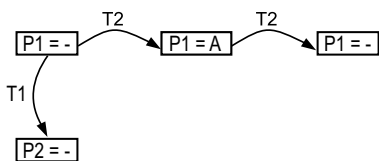

The parameters of the AOPD are divided into three menu groups.

- **P**: general AOPD functions
- **F**: Muting cyclic functions
- **L**: Muting and cyclic parameters

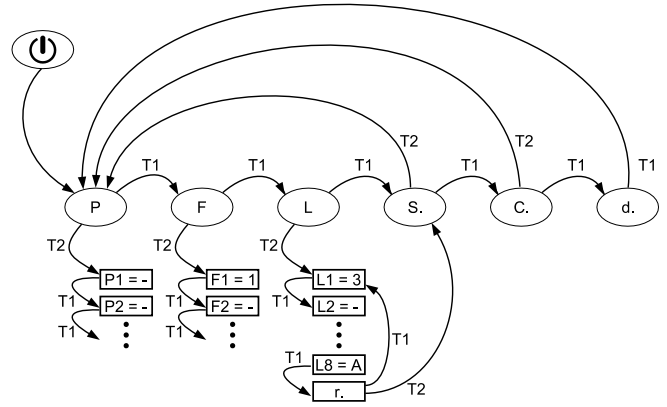

Parameter display

A	Parameter active
-	Parameter not active
n	Parameter not available, disabled
1.2...	Parameter has the configuration 1, 2 ...
S.	Save the current configuration
C.	Reset the current configuration to the factory settings
d.	Diagnostic/setting mode
r.	Leave parameter group

Reset to factory settings

	Display P after start in the operating mode parameter settings
	Repeated short presses on the pushbutton (max. 1.5 sec.) change to menu item C.
	Press the button again and hold (approx. 2.5 sec.) → C. flashes → Release the button as soon as C remains illuminated.
	The AOPD now sets the configuration to the factory settings and carries out a new start. The process is indicated by circulating in the 7 segment display.

Change parameters

In this example the muting function should be changed from F1 = 1 to F2 = 1.

	Display P after start in the operating mode parameter settings
	With a short button push (max. 1.5 sec.) change to menu item F.
	Press the button again and hold (approx. 2.5 sec.) → F flashes. → Release the button as soon as F remains illuminated. Change the menu to select the parameter in group F.
	Display of the current configuration F1 = 1. This causes the display to show the character string F 1 1
	A short press to change to parameter F2. Display: F2 is not active, F 2 -
	Press the button again and hold (approx. 2.5 sec.) → - flashes → Release the button as soon as 1 remains illuminated.
	Repeated short presses on the pushbutton (max. 1.5 sec.) change to menu item r. Then with a long press leave the menu group.
	The menu item save S. is shown. Press the button again and hold (approx. 2.5 sec.) → S. flashes → Release the button as soon as S. remains illuminated.
	The AOPD saves the configuration and initiates a new start. The process is indicated by circulating in the 7 segment display.

Show all configuration

	Display P after start in the operating mode parameter settings. Keep the button pressed for more than 10 seconds. The 10 seconds sequence is shown in the diagnostic window via a short signal of the yellow LED. Now you can release the button.
	The AOPD now shows all the parameters in a row that have been changed and do not correspond to the standard configuration.

General functions of the AOPD (parameter P)

No.	Status	Note
P1	-- = not active A = active n = locked	Blanking non-changeable objects Position active saves all interrupted beams through Teach-in mode.
P2	-- = not active A = active n = locked	Blanking non-changeable objects with moveable edge area Tolerance in edge region ± 1 beam - adjust safety distance.
P3	-- = not active 1 = 1 beam 2 = 2 beams n = locked	Blanking changeable objects Blanking of max. 2 beams - adjust safety distance.
P4	-- = not active 1/A = EDM 2 = belt-stop 3 = Muting-Enable	Function of the input D_IN refer to the description on the chapter: Protection control, muting and cyclic operation.
P5	-- = not active A = active n = locked	Operating mode Restart interlock with double acknowledgement/reset, acknowledge with command device S2
P6	-- = not active A = active	Alternative beam coding Activating upon mutual interference of identical systems.
P7	-- = not active A = active	Rotating the display through 180 degrees Rotating the display through 180 degrees
P8	-- = not active A = active	Multiple sampling Observed doubling of the reaction time, adjust safety distance.



The functions for the object blanking (P1, P2 and P3) are deactivated when the muting function is active. The functions band-stop or muting enable are parametrizable when a muting function is active.

Adapter KA-0976 for the parameter setting

If the wiring for the parameter setting of the receiver is not accessible, the KA-0976 adapter can be used as an alternative. The adapter is connected between the connecting cable and the cable connector of the receiver. The parameters are set by means of the command device (pushbutton), as described in the parameter setting. After the parameters have been set, the adapter is removed and the connecting cable is connected to the receiver.

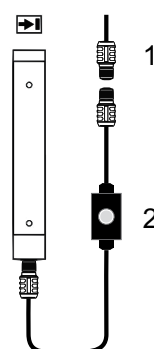

Key

- 1 = Connecting cable Receiver
- 2 = KA-0976 with command device pushbutton

3. Bridging function / muting

If objects are to be transported through the protection zone the protection function of the AOPD can be temporarily bridged via the muting function. The OSSDs remain in the ON state in spite of the interruption.

The interruption is initiated automatically from at least two independent signal sources (muting sensors) and ends after the sequence of the muting conditions or after the sequence of the preset muting cycle are complete.

The bridging function can be used in the automatic operating mode or restart interlock mode.



The operating mode restart interlock with double acknowledgement/reset is not supplied with the muting function.



The condition of the bridging function is shown via the integrated status indicator. An external muting light can be connected as an option. The function of an externally connected muting light is monitored via the AOPD.

Safety instructions for the bridging function



The bridging function should only be used for its intended purpose, the automatic transport of material.



The muting sensors should be placed in such a way that the transported material can be safely recognised and not the means of transporting such as a pallet. The bridging function should not be initiated by just one person (e.g. foot, leg, hand or arm movement).



The operating parameters, especially the muting cyclic time are to be adapted to the transport process of the application. The muting should only be active for the time that the material to be transported is blocking access to the hazardous area.



The access to the hazardous area should be designed in such a way that when the effective bridging function is active, access for persons to the hazardous area is not possible. Catching and crushing hazards must be considered.



The bridging function is initiated when an activation signal is received on the inputs MSG1 and MSG2 in the prescribed order or within the specified time frame.



There are two independent muting signal generators connected to the inputs MSG1 and MSG2 required. The switching edges should not reach the MSG1 and MSG2 at the same time. If switching edges are visible at the same time on the inputs then a short-circuit of the muting sensors is presumed. The muting signals should follow automatically and should not be under the complete control of software functions such by PLC.



The bridging function ends at the latest when the preset muting cyclic time has completed. The end of the bridging function is initiated when the bridged state of the first sensor input (MSG1 or MSG2) is released or inactive. The bridging time can be reduced by using the option "End muting via AOPD". Please observe further information in the description for each of the muting configurations.



The command switching device for release or to activate the manual bridging function (override) must be outside the hazardous area and should not be accessible from within the hazardous area.
 The command switching device should be installed in such a way the the operator can see the entire hazardous area.

3.1 Muting configuration

The AOPD following muting configuration parameter selection is offered.

No.	Status	Note
F1	– = not active n = locked 1,2,3 = Set no.	Muting with two sensors in parallel arrangement
F2	– = not active n = locked 1,2,3 = Set no.	Muting with two sensors in crossed arrangement.
F3	– = not active n = locked 1,2,3 = Set no.	Muting with four sensors in parallel arrangement
F4	– = not active n = locked 1,2,3 = Set no.	Special muting applications such as induction loops or loading/unloading process.
F5	1 = HI-active 2 = LO-active	Muting sensor dark operation Muting sensor light operation

Different configuration sets are offered with the parameter group F that provide the mostly used parameter combinations.

With the parameter group L all muting parameters can be individually set.



The procedure for the parameter setting is described in the section parameter setting.



If, after the selection of a muting configuration set, additional parameters are modified, they are signalled with the current configuration set by a U following the display sequence e.g. "F 1 1 U".

3.1.1 Muting with two sensors in parallel arrangement

When muting with two sensors in parallel, the switching sequence of the muting sensors are monitored sequentially. The bridging function starts as soon as both muting inputs MSG1 and MSG2 are active. Whereby MSG2 must be activated after MSG1.

The bridging function remains active for as long as the inputs (MSG1 and MSG2) are active and the muting cyclic time has not expired.

The next muting cycle can begin only once the whole muting area, with all sensors is free.



This configuration only allows the transport out of the hazardous area. The muting sensors must be installed within the hazardous area.

Multiple transport out of the hazardous area (F1 = 1, F1 = 3)

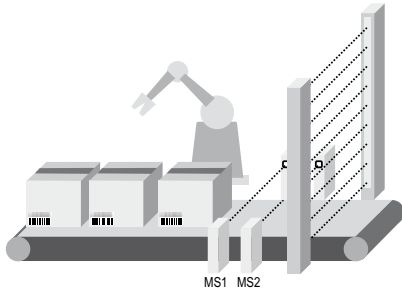

Transport goods at a short distance

If the distance between the transported objects is so small that all the sensors are not freed, the muting cycle has to be restarted differently. For this purpose the configuration F1 = 1 or F1 = 3 monitors the movement of the transport gaps and restarts the muting cycle. The transport gaps must be recognised by the sensors in the correct order, otherwise the muting cycle is not restarted (successive packets).

Individual transport out of the hazardous area (F1 = 2)

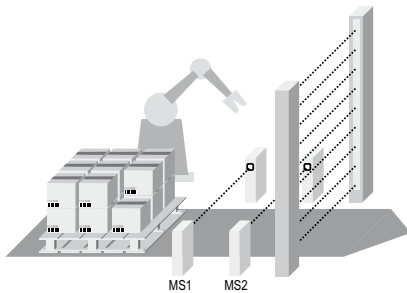

Transport of individual objects

The muting condition ends when one of the two muting inputs (MSG1 or MSG2) become inactive/free. With the end of the muting condition, the bridging is maintained for the duration of the preset muting-end-extension. This allows the transport through the protection zone to be completed.

Depending on which event occurs first the bridging is terminated when:

- the muting cycle time has expired,
- one of the muting inputs becomes free and the started end-extension has expired,
- the transport good is recognised by the AOPD and the protection zone has become free (option muting-end via AOPD).

The next muting cycle can begin once all the sensors have become inactive.



With "Muting-end via AOPD" (L4) the bridging time can be reduced. The transport good is recognised by the AOPD, the bridging is terminated as soon as the protection zone is no longer interrupted.



With "Bridging object gaps" (L5) the availability of the system is increased if the loading process is irregular and full of gaps.

Parameter set F1

Muting with two sensors in parallel arrangement	Parameter set F1			
	1	2	3	Param.
Muting cycle time	10 sec.	30 sec.	8 h.	L1
Sensor sequence (time)	--	--	--	L2
Sensor sequence (order)	✓	✓	✓	L3
Muting end via AOPD	✓	☑	✓	L4
Bridging of object gaps	☐	300 ms	☐	L5
Delay: Muting end	--	☐	--	L6
Delay: Muting start	--	--	--	L7
Partial muting	☐	☐	☐	L8
Successive packets	✓	--	✓	
Contactor control (EDM)	☐	☐	☐	P4
Belt-stop	☐	☐	☐	P4
Machine signal	☐	☐	☐	P4

- ✓ Function is active and cannot be changed.
- Function is inactive and cannot be changed.
- ☐ Function is optional and not active.
- ☑ Function is optional and already active.
- T Function is active, the time can be changed.

3.1.2 Muting with two sensors in crossed arrangement (F2)

In this configuration the muting sensors are arranged in such a manner that the light beams of the muting sensors cross.

The point of crossing is on the level of the AOPD protection zone or in the hazardous area. The muting sensors should be arranged so that the transport good activates them sequentially and not simultaneously. The switching difference should not be less than 50 ms.



Material can be transported in both directions.

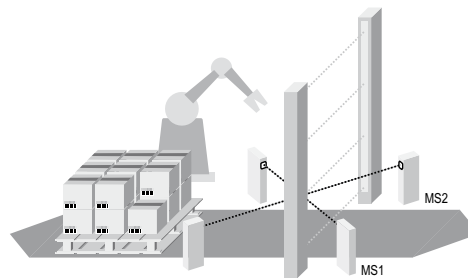

The bridging function starts as soon as both muting inputs (MSG1 and MSG2) are active. The order of switching is arbitrary, however the second input should go active within the preset time frame (parameter L2) of the first signal going active.

The bridging function remains active until one of the two muting inputs (MSG1 or MSG2) goes inactive or the muting cycle time expires.



With "Muting-end via AOPD" (L4) the bridging time can be reduced. The transport good is recognised by the AOPD, the bridging is terminated as soon as the protection zone is no longer interrupted.



With "Bridging object gaps" (L5) the availability of the system is increased if the loading process is irregular and full of gaps.



In this configuration (F2) the use of light switching muting sensors is (normally closed) is not allowed.

Parameter set F2

Muting with two sensors in crossed arrangement.	Parameter set F2			
	1	2	3	Param.
Muting cycle time	10 sec.	10 min.	8 h.	L1
Sensor sequence (time)	5 sec.	30 sec.	10 min.	L2
Sensor sequence (order)	<input type="checkbox"/>	<input type="checkbox"/>	<input type="checkbox"/>	L3
Muting end via AOPD	<input type="checkbox"/>	<input type="checkbox"/>	<input type="checkbox"/>	L4
Bridging of object gaps	100 ms	300 ms	5 sec.	L5
Delay: Muting end	<input type="checkbox"/>	<input type="checkbox"/>	<input type="checkbox"/>	L6
Delay: Muting start	--	--	--	L7
Partial muting	<input type="checkbox"/>	<input type="checkbox"/>	<input type="checkbox"/>	L8
Contactor control (EDM)	<input type="checkbox"/>	<input type="checkbox"/>	<input type="checkbox"/>	P4
Belt-stop	<input type="checkbox"/>	<input type="checkbox"/>	<input type="checkbox"/>	P4
Machine signal	<input type="checkbox"/>	<input type="checkbox"/>	<input type="checkbox"/>	P4

- ✓ Function is active and cannot be changed.
- Function is inactive and cannot be changed.
- Function is optional and not active.
- Function is optional and already active.
- T Function is active, the time can be changed.

3.1.3 Muting with four sensors in parallel arrangement (F3)

In this version two muting sensors are switched together on one sensor input (MSG1 and MSG2). Depending on the circuit, transport is possible in both directions or limited to just one direction.

Transport in both directions

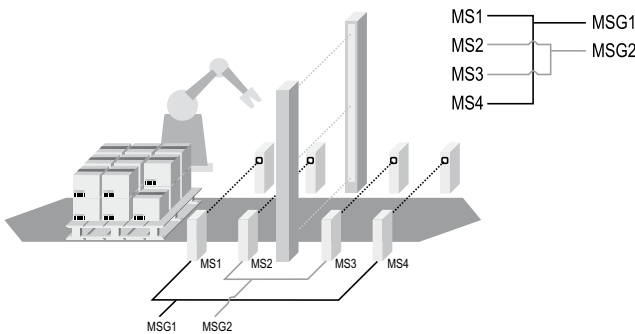

Transport in one direction

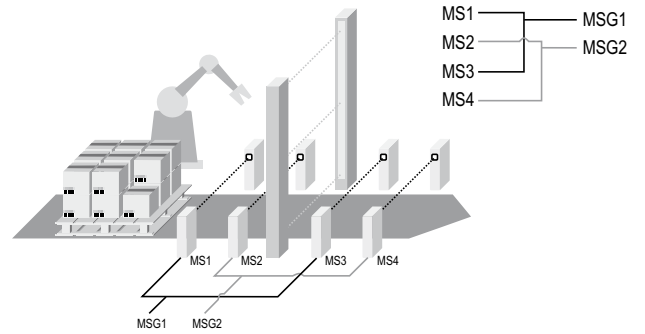

The bridging function starts as soon as both sensor inputs receive an active signal. At the same time the order is monitored so that MSG1 must be active before MSG2.

The bridging function remains active for as long as the inputs are active and the muting cyclic time has not expired. If one of the inputs becomes inactive the muting cycle ends.



With "Muting-end via AOPD" (L4) the bridging time can be reduced. The transport good is recognised by the AOPD, the bridging is terminated as soon as the protection zone is no longer interrupted.



With "Bridging object gaps" (L5) the availability of the system is increased if the loading process is irregular and full of gaps.

Parameter set F3

Muting with four sensors in parallel arrangement	Parameter set F3			
	1	2	3	Param.
Muting cycle time	10 sec.	10 min.	8 h.	L1
Sensor sequence (time)	<input type="checkbox"/>	<input type="checkbox"/>	<input type="checkbox"/>	L2
Sensor sequence (order)	<input checked="" type="checkbox"/>	<input checked="" type="checkbox"/>	<input checked="" type="checkbox"/>	L3
Muting end via AOPD	<input type="checkbox"/>	<input type="checkbox"/>	<input type="checkbox"/>	L4
Bridging of object gaps	100 ms	300 ms	10 sec.	L5
Delay: Muting end	<input type="checkbox"/>	<input type="checkbox"/>	<input type="checkbox"/>	L6
Delay: Muting start	--	--	--	L7
Partial muting	<input type="checkbox"/>	<input type="checkbox"/>	<input type="checkbox"/>	L8
Contactor control (EDM)	<input type="checkbox"/>	<input type="checkbox"/>	<input type="checkbox"/>	P4
Belt-stop	<input type="checkbox"/>	<input type="checkbox"/>	<input type="checkbox"/>	P4
Machine signal	<input type="checkbox"/>	<input type="checkbox"/>	<input type="checkbox"/>	P4

- ✓ Function is active and cannot be changed.
- Function is inactive and cannot be changed.
- Function is optional and not active.
- Function is optional and already active.
- T Function is active, the time can be changed.

3.1.4 Special muting applications

Using the parameter set F4 it is possible to adapt the muting function to special applications.

For example, the loading and unloading using a fork-lift.

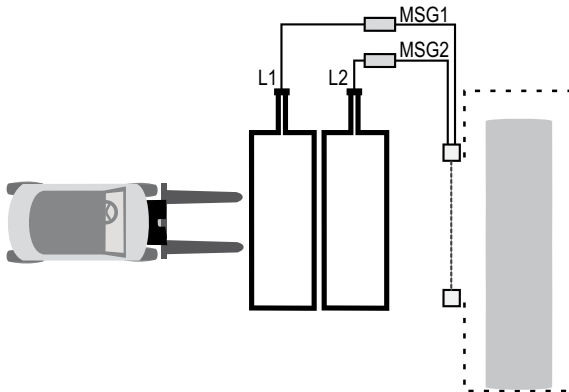

Here two induction loops are used. The induction loop signals are evaluated by feeding the muting inputs MSG1 and MSG2 to a separate electronics unit.

The following process configuration can be configured using F4 = 1:

- The muting sequence starts as soon as the muting inputs are activated and remain active for at least 3 seconds (muting-start-delay, parameter L7).
- The muting cycle time (L1) should be selected to take into account the duration of the loading and unloading.
- The time for the switching sequence is monitored, this means that both sensor inputs must become active within a configured time frame (L2).
- The muting remains active until the first muting sensor becomes free or the muting cycle time has expired.
- To temporarily bridge the interruption of a sensor signal with manoeuvring operations, the bridging time of 3 seconds (L5) is preset.



Further measures are to be provided by the operator to prevent the start of a muting cycle due to crossing traffic. Such as controlling the locking or unlocking of a muting cycle by a machine (option P4 = 3).

Parameter set F4

Special muting applications	Parameter set F4			
	1	2	3	Param.
Muting cycle time	30 sec.	30 sec.	30 sec.	L1
Sensor sequence (time)	5 sec.	<input type="checkbox"/>	5 sec.	L2
Sensor sequence (order)	<input type="checkbox"/>	<input checked="" type="checkbox"/>	<input type="checkbox"/>	L3
Muting end via AOPD	<input type="checkbox"/>	<input type="checkbox"/>	<input checked="" type="checkbox"/>	L4
Bridging of object gaps	3 sec.	3 sec.	3 sec.	L5
Delay: Muting end	<input type="checkbox"/>	<input type="checkbox"/>	<input type="checkbox"/>	L6
Delay: Muting start	3 sec.	3 sec.	3 sec.	L7
Partial muting	<input type="checkbox"/>	<input type="checkbox"/>	<input type="checkbox"/>	L8
Sensor signal after AOPD release	✓	✓	--	
Contactor control (EDM)	<input type="checkbox"/>	<input type="checkbox"/>	<input type="checkbox"/>	P4
Belt-stop	<input type="checkbox"/>	<input type="checkbox"/>	<input type="checkbox"/>	P4
Machine signal	<input type="checkbox"/>	<input type="checkbox"/>	<input type="checkbox"/>	P4

- ✓ Function is active and cannot be changed.
- Function is inactive and cannot be changed.
- Function is optional and not active.
- Function is optional and already active.
- T Function is active, the time can be changed.

3.2 Muting parameters

Summary of the muting parameters

No.	Status	Note
L1	-- = not active 1 = 5 sec. 2 = 10 sec. 3 = 20 sec. 4 = 30 sec. 5 = 10 min. 6 = 1 h. 7 = 8 h. 8 = 80 h.	Cycle time: • Muting cycle time (up to 80 hours) • Cycle time (up to 30 seconds)
L2	-- = not active 1 = 1 sec. 2 = 3 sec. 3 = 5 sec. 4 = 30 sec. 5 = 10 min. 6 = 1 h.	Time limited monitoring of the switching signals of muting sensors.
L3	-- = not active A = active	Monitoring the switching order from muting sensors.
L4	-- = not active A = active	Muting end via AOPD
L5	-- = not active 1 = 100 ms 2 = 300 ms 3 = 500 ms 4 = 1 sec. 5 = 3 sec. 6 = 5 sec. 7 = 10 sec. 8 = 30 sec.	Bridging of object gaps. Drop-out delay of muting sensors and the protection zone when a muting cycle is active.
L6	-- = not active 1 = 1 sec. 2 = 3 sec. 3 = 5 sec. 4 = 10 sec.	Muting end delay
L7	-- = not active 1 = 1 sec. 2 = 3 sec. 3 = 5 sec. 4 = 10 sec.	Muting start delay
L8	-- = not active 1 = 1 beam 2 = 2 beams A = Teach-IN	Limiting the bridged protection area range (partial muting)
P4	-- = not active 1 = EDM 2 = belt-stop 3 = ME	Function of the input D_IN Contactor control Bandstop signal Muting release via machine signal
F5	1 = HI-active 2 = LO-active	Muting sensor dark operation Muting sensor light operation

3.2.1 Muting cycle time (parameter L1)

The muting cycle time (T_z) is the set maximum duration from the start of the bridging until the termination of the bridging by the timer.

The muting cycle starts with fulfillment of the muting start conditions by signals from the muting sensors (both sensor inputs, MSG1 and MSG2 become active) and ends with the intended sequence after reaching the muting end condition (the first sensor input becomes active).

If the muting-end condition is not fulfilled before the preset cycle time has expired the muting is terminated by the counter. If an object is in the protection zone (PZ) at this time the AOPD switches to the OFF state. If the protection zone is clear at this time the AOPD remains in the ON state and the muting warning U5 is shown. The next muting cycle is first possible when all sensors are free (inactive).

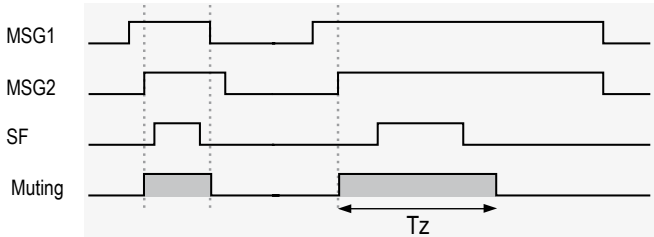

The cycle time should be suitably preset for the transport duration.

3.2.2 Time limited monitoring of the switching signals of muting sensors (Parameter L2)

If it is not possible to monitor the muting sensors order of switching due to their location then the time differences between the first sensor switching and the second sensor is monitored.

If both switching signals are within the preset timeframe (T_s) the bridging function is started. If the second signal is not within the timeframe (T_s) the bridging function will not be activated and the muting warning U4 is shown.

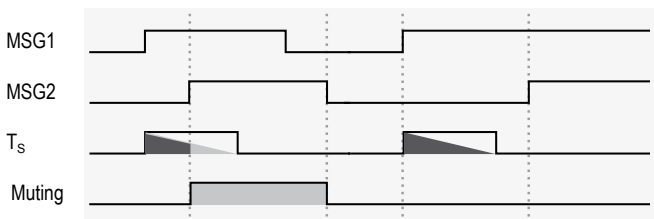

If the time difference between the switching signals is greater than 4 seconds then a muting configuration should be selected that monitors the order of switching.



This configuration should not be used with light switching muting sensors.

3.2.3 Monitoring the switching order from muting sensors (Parameter L3)

If the monitoring of the switching order is activated the time between switching of the first muting input and the switching of the second muting input has no relevance. In this case the order of switching is monitored.

The switching signal must first occur on input MSG1 and then on input MSG2. If MSG2 is active before MSG1, the bridging function cannot be started and a muting warning U3 is shown.

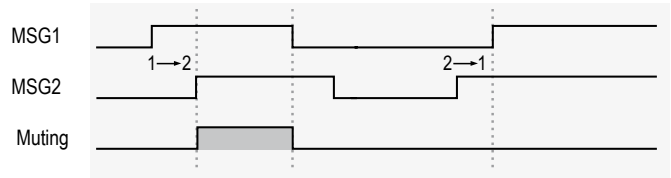

Muting with two sensors is limited to a duration of 8 hours for switching from MSG1 to MSG2. Muting with four sensors is limited to a duration of 80 hours.

3.2.4 Reducing the bridging time with muting-end via the AOPD (Parameter L4)

The muting cycle can be reduced with the option muting-end through the AOPD when the transport good is recognised by the AOPD protection zone (SF) and the bridging function is active. Once the transport good leaves the protection zone the bridging function is terminated.

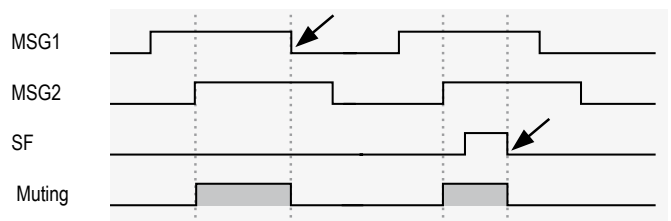

The next muting cycle can begin once all the sensors have become inactive (free).



This function cannot be combined with the "Muting-end delay". Once the "Muting-end via AOPD" is activated, the function "Muting-end delay" is disabled.



The function Muting-end via AOPD does not have any effect on the cordoning measures and protection equipment.

3.2.5 Bridging of object gaps (Parameter L5)

If gaps are expected with the transport goods the function for suppressing the sensor gaps can be activated. Here the maximum bridging duration (TG) of the sensor evaluation can be preset.

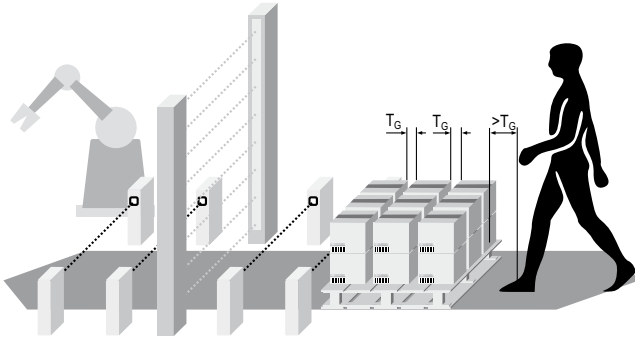

The bridging of object gaps has an effect similar to a drop-out delay of the sensor signals. Makes sure that the preset bridging duration does not allow a person to follow the transport good into the hazardous area.



It should be noted, that the muting-end is delayed by the preset bridging duration (T_G).



The height of the bridged protection zone that a transport good (but not people) can pass through can be preset in the parameter L8.

3.2.6 Muting-end delay (Parameter L6)

The Muting-end delay is needed especially for muting with two sensors arranged in parallel, this allows the transport good sufficient time to leave the muting area after clearing the first sensor.

This can be helpful also with other application to extend the bridging duration when for example the end of the transport good cannot be reliably recognised by the muting sensors (drooping sheet).



The access to the hazardous area should be designed in such a way that when the effective bridging function is active, access for persons to the hazardous area is not possible.



The function cannot be combined with the option "Muting-end via AOPD". If this function is activated an already active option "Muting-end via AOPD" will be deactivated.

3.2.7 Muting-start delay (Parameter L7)

In some special applications it may be necessary to delay the bridging function even though a valid start conditions is present. This options allows a time limited start delay to be preset.

The delay starts when both the sensors inputs MSG1 and MSG2 become active. During this time interval form the start of the delay to the activation of the bridging function, both sensor inputs must remain active.



This option can only be selected in combination with the parameter group F4.

3.2.8 Limiting the bridged protection area range (Parameter L8)

This functions allows the area of the bridged protection zone to be limited. This allows the transport good to pass with a defined height of the bridged protection zone, while the AOPD is in the OFF state due to the interruption of the non-bridged protection zone.

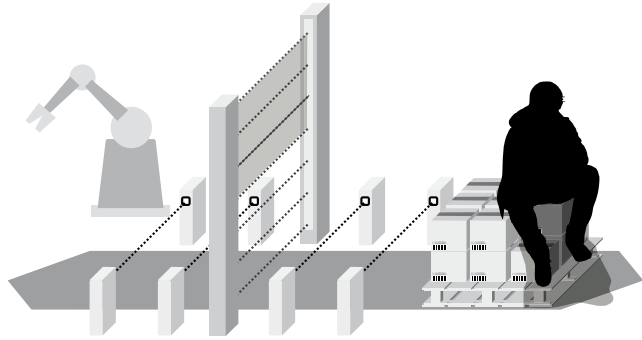

The parameter L8 allows the number of disable beams (one or two) to be preset or an area for the Teach-in process to be defined.



With this function the first beam after the diagnostic window should not be interrupted, therefore the AOPD should be installed with the connector upwards. Turn the 7 segment display by selecting the parameter P7 = A.

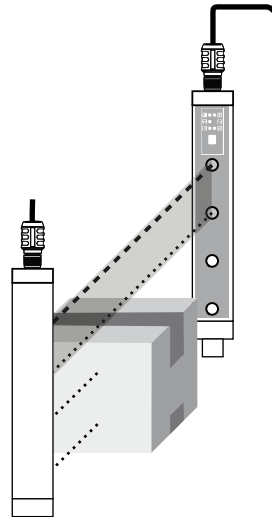

Teach-in process

- When in the operating mode parameterization change to parameter L8.
- Bring the transport good into the protection zone of the AOPD.
- Implement a Teach-in process with the selection of option A.
- The AOPD now saves the height of the transport good. If the Teach-in process was successful this is confirmed with the display sequence "L 8 A". If it was not possible to carry out the Teach-in process this is acknowledged by the display sequence "L 8 -".



The limitation of the bridged protection zone is not possible with a SLG445 with two beams and with a SLG445 with three or four beams is limited to a single beam in the configuration.

3.2.9 Belt-stop signal (Parameter P4 = 2)

The function "belt-stop signal" can be used to temporarily stop an already started bridging action by asserting a HI-level on the input D_IN. This causes all counters to stop until the belt-stop signal is terminated. Once the signal on the input D_IN returns to the LO-level the sequence of the bridging function is continued.

The belt-stop signal of the machine controller is connected to the input D_IN (pin 9). In the hibernation mode a LO-level (0V) is expected on the input. Changing the signal voltage to the HI-level (+24V) signals a belt-stop to the machine control.

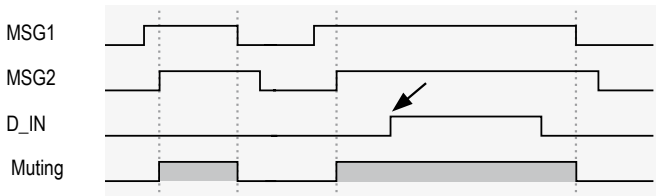

The maximum duration of the belt-stop is limited to 10 hours. At the end of the belt-stop time the AOPD changes to the OFF state and issues the muting warning U7.



When the belt-stop signal is active the sensor inputs and the protection zone continue to be monitored. During the belt-stop only one sensor signal at the most can change (MSG2, MSG2 or protection zone). If more that one sensor changes its signal state, the bridging function is terminated, if at this point in time the protection zone of the AOPD is interrupted the AOPD changes its state to OFF.

3.2.10 Muting release via machine signal (Parameter P4 = 3)

With this function the bridging can be allowed by an external signal of be disabled.

If a HI signal (+24V) is on the input D_IN (pin 9) then at the end of a valid sensor sequence the bridging function is activated. If at the time of the sensor activation a LO signal (0V) on the input D_IN the bridging function is prohibited.



The muting release can be present for 10 hours at the most without interruption. Thereafter the release is automatically disabled until a new LO-HI signal change is recognised.



The muting release signal is allowed to change to the LO-level as soon as the bridging function is active.



After the AOPD system start the external LO-level release signal must be present for at least 50 ms before a HI-signal can be accepted for release.

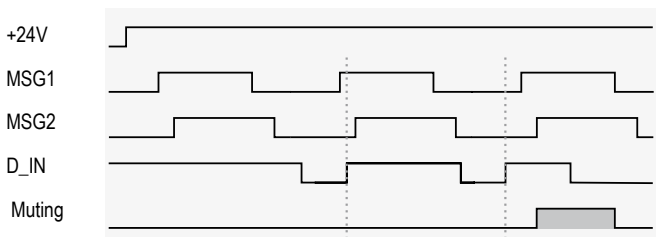

3.3 Manual bridging function (Override)

The muting sequence can be interrupted for operational reasons during the time that a transport good is passing through the muting area (such as with the loss of power).

To be able to remove the transport good from the muting area without any danger, the AOPD offers a restart function to manually drive-clear the muting area.

The bridging function is activated when:

- on the input a defined signal sequence is recognised (long button press (3 to 6 seconds) → pause (max. 1 sec. → press and hold button again).
- at least one sensor is active (muting sensor, AOPD protection zone (SF)).

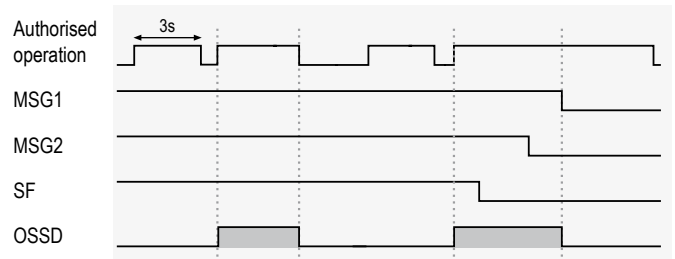

The bridging remains active until all sensors are free (inactive), the release button is no longer held down or the preset duration for the bridging (10 seconds) has expired.

If the muting area is still not free after the expiration of the duration, the process can be repeated.



The bridging function is shown by a signal (yellow) on the status lights.



In the operating mode restart interlock, the AOPD changes after the sensors and the protection zone are free to the OFF state.



In the automatic operation mode the AOPD remains in the ON state after the protection zone sensors are freed, the status light changes from yellow to green.

3.4 Muting sensors (Parameter F5)

All sensors are suitable to be used as muting sensors, they emit a signal level of 0V to +24V.

They are for example:

- Optoelectronic sensors
- Mechanical position switches
- Capacitive and inductive sensors with evaluation electronics
- Signal from a control system

Set the polarity of the sensor signals using the parameter F5:

F5 = 1	Signal HI active, normally open, dark switching sensor.
F5 = 2	Signal LO-active, normally closed, light switching sensor

In configurations with sequence monitoring of the sensor switching order the sensors are to be placed so that the switching signal on input MSG1 is present before MSG2.

In configurations with duration monitoring the sensor switching sequence of the sensors should be so that both sensors switch within the configured timeframe (parameter L2). Simultaneous switching of the sensors should be avoided.

The spacing of the muting sensor to the AOPD should be selected so that the switching signal of the sensor takes place at least 50 mm before the material reaches the protection zone (min. 100 mm with a belt speed of 2 m/s). The distance however should be no more than 200 mm.



The selected sensor model must be suitable for the application and mounted in a tamper proof manner.



The muting sensor should be installed in such a way that the bridging function cannot be triggered by a person (e.g. foot, leg, hand or arm movement), and the transport good can be safely recognised.



When reflection light barriers are used, the sensors and reflectors must be arranged in an alternate order to prevent any mutual interference.

3.5 Muting signals and status message

The current condition of the AOPD is indicated by the status indicator. Alternatively an external muting light can be connected to signal the bridging of the AOPD.

Status signals

AOPD condition	Description
OSSD-EIN	Status display GREEN Muting lamp OFF
OSSD-AUS	Status display RED Muting lamp OFF
Muting / Override	Status display YELLOW Muting lamp ON
Muting state	Status display YELLOW pulses two times per second

Muting state

The following table describes the muting status messages.

CODE	Description
U0	Belt-stop signal is active.
U1	Check for short-circuit on the signal inputs MSG1 and MSG 2.
U2	Check the signal on the signal inputs MSG1 and MSG2.
U3	Switching order of the sensors not complied with.
U4	Time exceeded with the sensor switching sequence monitoring.
U5	Time exceeded with the muting cycle time.
U6	No muting release from the machine control.
U7	Time exceeded with the belt-stop signal.
U8	Interruption of the beams with limited bridging of the protection zone area.

4. Cyclic operation

4.1 Betriebsarten

The operating mode cyclic operation can be used when objects are to be manually placed and removed from the hazardous area. The machine cycle is automatically started again when the protection zone is clear after being interrupted once or twice.

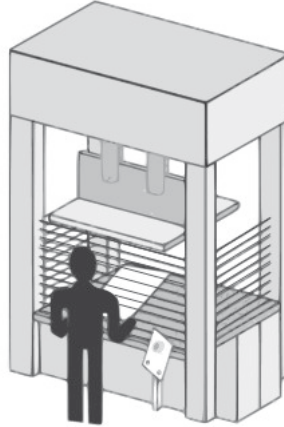

Operating cycle

When starting the machine the start interlock should be cancelled before the first work cycle by releasing the command switching device (button release) and the protection field intervention. The release can only occur after the machine signal is present on the inputs MK1 and MK2.

The restart interlock is activated

- after the operating voltage is switched on,
- when the protection zone (SF) of the AOPD is interrupted during a hazardous movement,
- after expiration of the cycle time(max. 30 sec.), this means if the machine cycle is not completed of the next machine cycle is not activated.

To monitor the machine cycle, a machine signal is required on the inputs MK1 and MK2 of the AOPD. The end of the hazardous movement is signalled by the machine controller with a HI-LO-pulse that has a pulse-width between 50 and 1000 ms.



If only one machine signal is available the signal should be connected to both inputs MK1 and MK2 by using a jumper.

1 cyclic operation

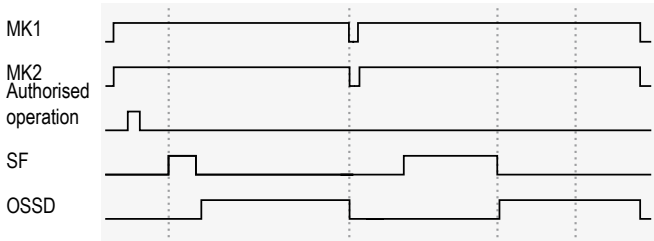

2 cyclic operation

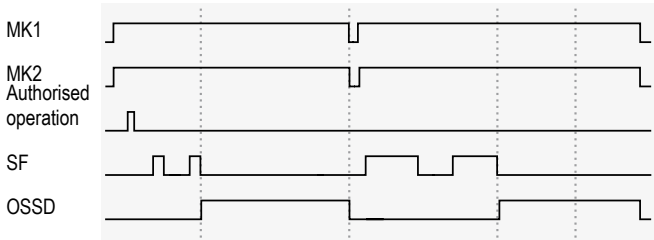

Activating the function and parameter

The cyclic operation is activated in the parameter settings with the parameter F6.

	Cyclic operation not active
	1 cyclic operation
	2 cyclic operation

The cyclic operation can be preset in the range from 5 to 30 seconds with the parameter L1.

Status signals

The current condition of the AOPD is indicated by the status indicator.

AOPD condition	Description
No machine signal	<ul style="list-style-type: none"> Status display RED LED restart (yellow) light pulses in 3 second intervals
Restart interlock (manual reset)	<ul style="list-style-type: none"> Status display RED LED restart (yellow) illuminates
Expected operator intervention to release the machine movement	<ul style="list-style-type: none"> Status display RED LED restart (yellow) 2 light pulses per second.
Machine movement	<ul style="list-style-type: none"> Status display GREEN LED restart (yellow) no light-pulse

The operating mode cyclic operation is signalled cyclically by 3 light pulses on the info LED (yellow-green). Refer to chapter Diagnostics, Status information LED.

5. Mounting

5.1 General conditions

The following guidelines are provided as preventive warning notices to ensure a safe and appropriate handling. These guidelines are an essential part of the safety instructions and therefore must always be observed and respected.



- The AOPD must not be used on machines that cannot be separated from the power in the event of an emergency.
- The safety distance between the AOPD and the hazardous point must always be respected and observed.
- Additional mechanical safety guards must be installed so that the operator has to pass by the protection field to reach the hazardous machine parts.
- The AOPD must be installed so that the personnel always must be within the detection zone when operating the machine. An incorrect installation can lead to serious injuries.
- Never connect the outputs to +24VDC. If the outputs are wired to +24VDC, they are in ON state, as a result of which they are unable to stop a hazardous situation occurring on the application/machine.
- The safety inspections must be conducted regularly.
- The AOPD must not be exposed to inflammable or explosive gasses.
- The connecting cables must be connected in accordance with the installation instructions. The electrical connection should be protected against unauthorised changes.
- The fixing screws of the end caps and the mounting angle must be firmly tightened.

5.2 Protection field and approach

The protection field of the AOPD consists of the entire range located between the protection field markings of transmitter and receiver. Additional protective devices must ensure that the operator has to pass through the protection zone to reach the hazardous area. The AOPD must be installed so that personnel are always located within the detection zone of the safety device when operating the hazardous machine parts to be secure.

Correct installation

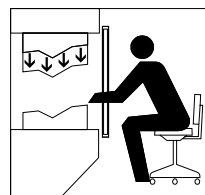

Hazardous machine parts can only be reached after passing through the protection field.

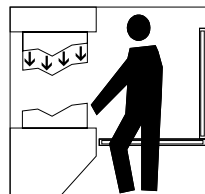

The presence of staff members between the protection field and hazardous machine parts must be prevented/avoided (protection against stepping over).

Unauthorised installation

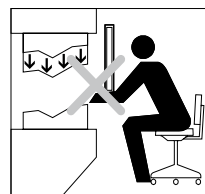

Hazardous machine parts can be reached without passing through the protection field.

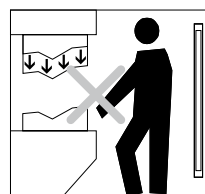

The presence of staff members between the protection field and hazardous machine parts is enabled.

5.3 Alignment of the sensors

Procedure:

1. The transmitter and the receiver must be fitted parallel to each other and at the same height.
2. Choose the operating mode and switch the operating voltage on.
3. The 7 segment display in the receiver shows the current signal strength/fine adjustment (signalling see chapter: "set-up mode") for a duration of 30 seconds.
Rotate the transmitter and then the receiver towards each other until you have the best possible signal strength of 3 horizontal bars (7 segment display) (note that 2 horizontal bars is sufficient). Fix this position using the screws to the mounting angle. If the set-up is not possible within 30 seconds, change to set-up mode (see chapter "set-up mode").
The set-up mode leads to the best possible positioning of the sensors through the basic setting (position of the second and last beam) and the optimisation with the fine adjustment (total signal).
Status indication of the LEDs
OSSD ON (green) is active, signal strength (orange) is not active.

5.4 Setting mode

Set-up tool with 7-segment display



The function supports the best possible alignment between transmitter and receiver. The indication shows the signal strength of the different receivers while the safety outputs are switched off. For the optical indication of the signal strength two areas are available, the signal strength of the second (with SLG445 first) and the last beam in the protection zone (default setting) as well as the best possible orientation of all beams (find adjustment).

Activating setting mode

After the system start, a signal (HI signal 24 VDC) must be present at the input restart interlock (pin 3) of the receiver for at least 2.0 seconds (pushbutton/enabling).
The 7 segment display starts with the default setting (vertical bar). The sensors are aligned in parallel and at the same height until both segments have reached a signal strength of 50% to 100%.
With a signal impulse on the input release (pin 3) you can change between default setting and fine adjustment as long as the signal strength is at 50% of the default setting (vertical bar).
After the setting of the sensors, the setting mode can be terminated by the presence of a HI-signal at pin 3 for at least 2.5 seconds (max. 6 seconds) and the actuation of the enabling button or by a voltage reset at the receiver (+UB).

Alignment

Receiver not parallel

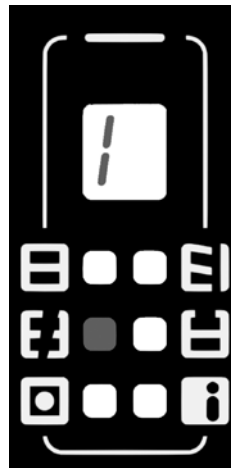
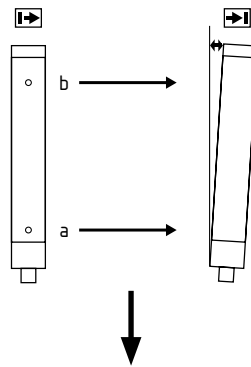

Beam (a) = receive signal OK
Beam (b) = no receive signal

Both sensors parallel

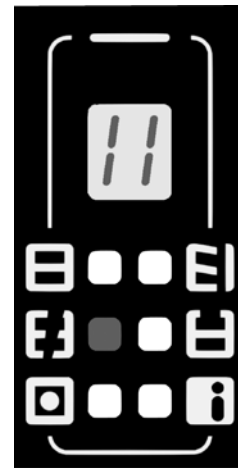
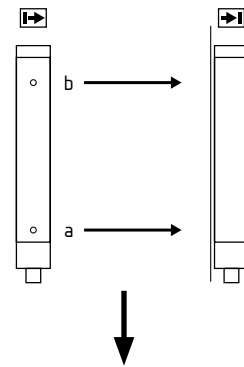

Beam (a) and beam (b) = receive signals OK

Indication basic setting

The signal strength is displayed per beam with two segments for the 2nd (a) and the last (b) beam.

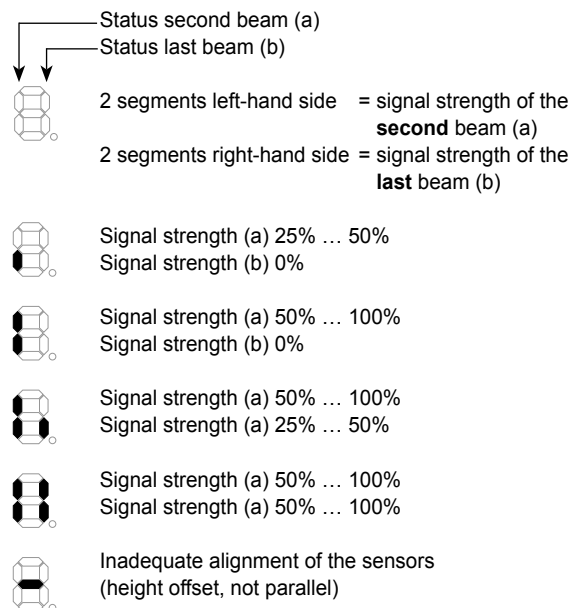

CAUTION! The signal strength of the SLG445 is shown for the first (a) and the last (b) beam.

Indication fine adjustment

The fine adjustment is displayed by means of up to 3 segments (cross-bars) for the best possible signal strength of all beams.

	Best possible signal strength
	Signal strength for normal operation
	- Signal strength is sufficient, if one or more beams in the protection zone are covered (object blanking) - Signal strength insufficient, when no beams are covered



The availability of the system is also assured if due to soiling or operation at nominal range the best possible signal strength (3 segments) is not reached.

5.5 Safety distance

The safety distance is the minimum distance between the protection zone of the AOPD and the hazardous point. The safety distance must be observed to ensure that the hazardous point cannot be reached before the hazardous movement has come to standstill.

Calculation of the safety distance to EN ISO 13855 and EN ISO 13857

The safety distance depends on the following elements:

- Stopping time of the machine (calculation by run-on time measurement)
- Response time of the machine and the safety light curtain and the downstream safety-monitoring module (entire safety guard)
- Approach speed
- Resolution of the AOPD

Safety light curtain SLC445

The safety distance for resolutions 14 mm up to 40 mm is calculated by means of the following formula:

$$(1) S = 2000 \text{ mm/s} * T + 8 (d - 14) \text{ [mm]}$$

S = Safety distance [mm]

T = Total reaction time (machine run-on time, reaction time of the safety guard, relays, etc.)

d = Resolution of the AOPD in mm

The approach speed is covered with a value of 2000 mm/s.

If value $S \leq 500$ mm after the calculation of the safety distance, then use this value.

If value $S \geq 500$ mm, recalculate the distance:

$$(2) S = 1600 \text{ mm/s} * T + 8 (d - 14) \text{ [mm]}$$

If the new value $S > 500$ mm, use this value as safety distance.

If the new value $S < 500$ mm, use a minimum distance of 500 mm.

Example

Response time of the AOPD = 10 ms

Resolution of the AOPD = 14 mm

Stopping time of the machine = 330 ms

$$S = 2000 \text{ mm/s} * (330 \text{ ms} + 10 \text{ ms}) + 8(14 \text{ mm} - 14 \text{ mm})$$

$$S = 680 \text{ mm}$$

$$S > 500 \text{ mm, therefore new calculation with } V = 1600 \text{ mm/s}$$

$$S = 544 \text{ mm}$$

Safety distance to the hazardous area

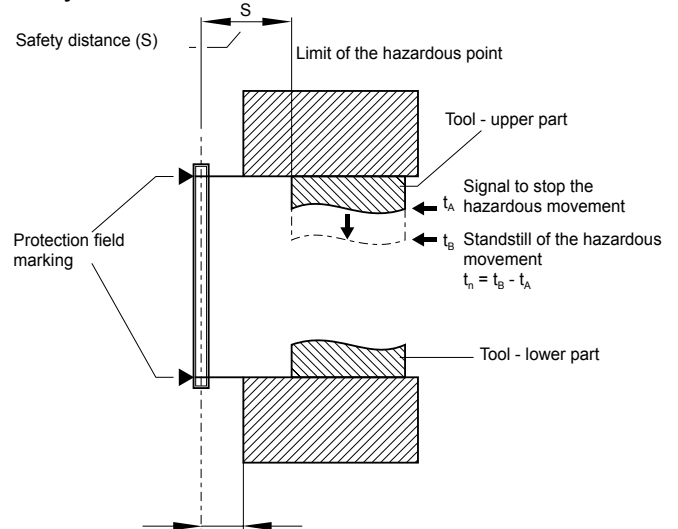

≤ 75 mm = max. distance for protection against stepping over
To prevent persons from stepping over the protection field this dimension must be imperatively respected and observed.

Calculation of the safety distance for the multi-beam light grid SLG445

$$S = (1600 \text{ mm/s} * T) + 850 \text{ mm}$$

S = Safety distance [mm]

T = Total reaction time (machine run-on time, reaction time of the safety guard, relays, etc.)

K = Approach speed 1600 mm/s

C = Safety supplement 850 mm

Example

Reaction time of the SLG445 = 10 ms

Stopping time of the machine T = 170 ms

$$S = 1600 \text{ mm/s} * (170 \text{ ms} + 10 \text{ ms}) + 850 \text{ mm}$$

$$S = 1138 \text{ mm}$$

The following mounting heights must be observed:

Number of beams	Mounting height above reference floor in mm
2	400, 900
3	300, 700, 1100
4	300, 600, 900, 1200

Safety distance to the hazardous area

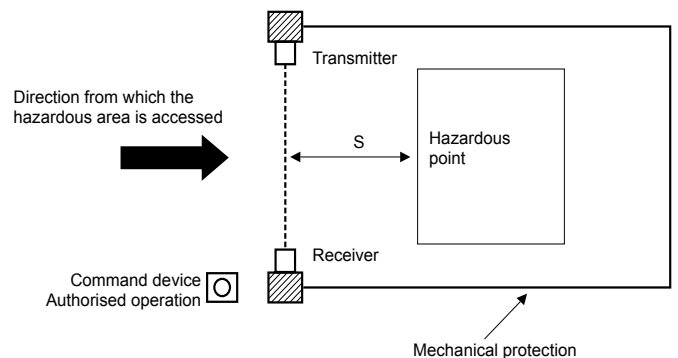

The formulae and calculation examples are related to the vertical set-up (refer to drawing) of the safety light grid with regard to the hazardous point. Please observe the applicable harmonised EN standards and possible applicable national regulations.



The safety distance between the AOPD and the hazardous point must always be respected and observed. If a person reaches the hazardous point before the hazardous movement has come to a standstill, he or she is exposed to serious injuries.



To calculate the minimum distance to the hazardous point the EN ISO 13855 and EN ISO 13857 must be observed. If an overlap of the protection field is possible, take care with the calculation of the safety distance referring to additional CRO according to the table A1 as per norm EN ISO 13855.

5.5.1 Minimum distance to reflecting surfaces

During the installation, the effects of reflecting surfaces must be taken into account. In case of an incorrect installation, interruptions of the protection field could possibly not be detected, which could lead to serious injuries. The hereafter-specified minimum distances with regard to reflecting surfaces (metal walls, floors, ceilings or parts) must be imperatively observed.

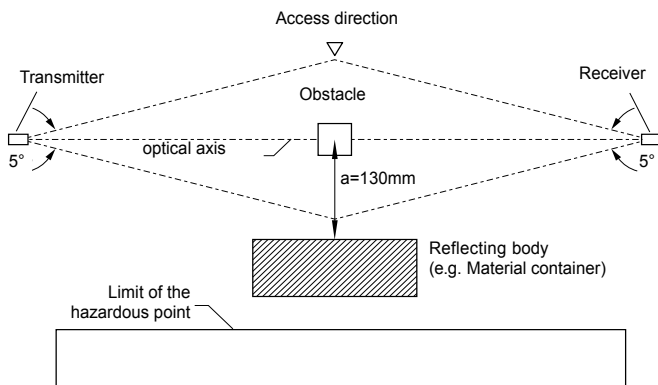

Safety distance a

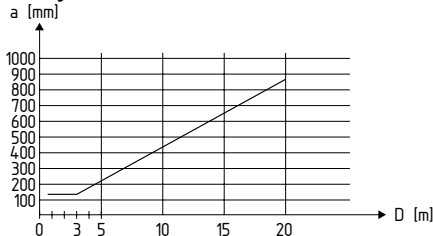

Calculate the minimum distance to reflecting surfaces as a function of the distance with an aperture angles of $\pm 2.5^\circ$ degrees or use the value from the table below:

Distance between transmitter and receiver [m]	Minimum distance a [mm]
0.2 ... 3.0	130
4	175
5	220
7	310
10	440
12	530

Formula $a = \tan 2.5^\circ \times L$ [mm]

a = Minimum distance to reflecting surfaces
L = Distance between transmitter and receiver

5.6 Dimensions

5.6.1 Dimensions transmitter and receiver SLC445

All measurements in mm.

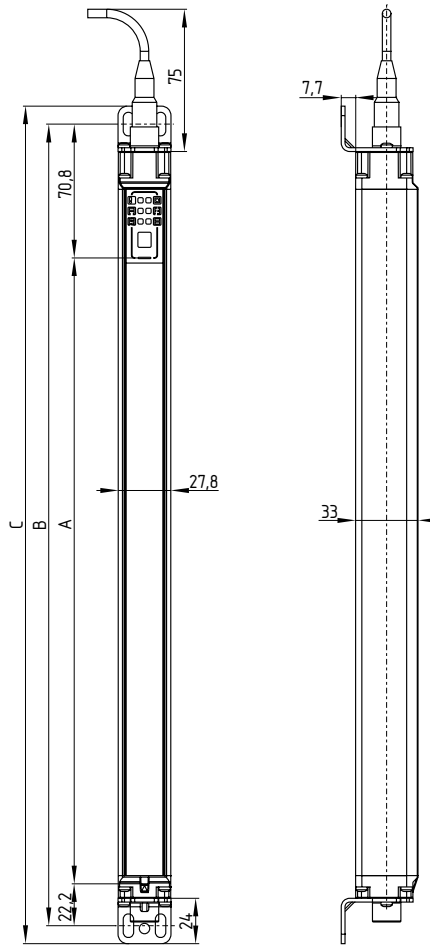

Type	A Protected height ± 1	B Mounting dimension ± 1	C Total length ± 1
SLC445-ER-0170-XX-01	170	264	283
SLC445-ER-0250-XX-01	250	344	363
SLC445-ER-0330-XX-01	330	424	443
SLC445-ER-0410-XX-01	410	504	523
SLC445-ER-0490-XX-01	490	584	603
SLC445-ER-0570-XX-01	570	664	683
SLC445-ER-0650-XX-01	650	744	763
SLC445-ER-0730-XX-01	730	824	843
SLC445-ER-0810-XX-01	810	904	923
SLC445-ER-0890-XX-01	890	984	1003
SLC445-ER-0970-XX-01	970	1064	1083
SLC445-ER-1050-XX-01	1050	1144	1163
SLC445-ER-1130-XX-01	1130	1224	1243
SLC445-ER-1210-XX-01	1210	1304	1323
SLC445-ER-1290-XX-01	1290	1384	1403
SLC445-ER-1370-XX-01	1370	1464	1483
SLC445-ER-1450-XX-01	1450	1544	1563
SLC445-ER-1530-XX-01	1530	1624	1643
SLC445-ER-1610-XX-01	1610	1704	1723
SLC445-ER-1690-XX-01	1690	1784	1803
SLC445-ER-1770-XX-01	1770	1864	1883

The overall length Ls (dimension end cap with regard to the cable connection up to the connector M12) of the sensors is calculated in the following way:

Transmitter

Ls = size B - 13 mm

Example **SLC445-E-0970**

Ls = 1064 - 13 mm

Ls = 1051 mm

Receiver

Ls = size B - 3 mm

Example **SLC445-R-0970-01**

Ls = 1064 - 3 mm

Ls = 1061 mm

5.6.2 Dimensions transmitter and receiver SLG445

All measurements in mm.

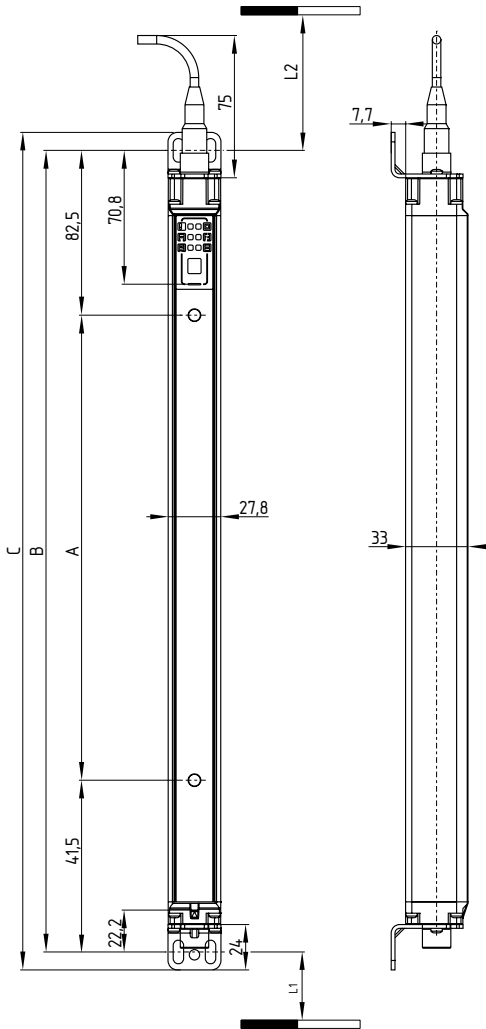

Type	A Beam distance	B Moun- ting dimen- sion	C Total length	L1	L2
SLG445-ER-0500-02-XX	500	624	643	358.5	317.5
SLG445-ER-0800-03-XX	400	924	943	258.5	217.5
SLG445-ER-0900-04-XX	300	1024	1043	258.5	217.5

L1 = Mounting distance (mm) between floor and slotted hole centre (short end cap)

L2 = Mounting distance (mm) between floor and slotted hole centre (diagnostic window)

Total length Ls of the sensors

	Transmitter	Receiver
SLG445-ER-0500-02-XX	611	621
SLG445-ER-0800-03-XX	911	921
SLG445-ER-0900-04-XX	1011	1021

Ls = Dimension end cap with regards to the cable connection up to the connector M12

5.7 Fixing

5.7.1 Included in delivery

Mounting kit MS-1100

The mounting kit consists of 4 steel angles and 8 fixing screws (Type Torx plus 10IP).

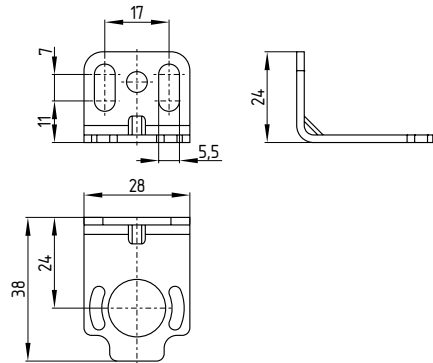

Integrated status indication

The status indication at the receiver indicates the switching condition of the outputs OSSD1 and OSSD2.

- Green = outputs HI-signal 24V
- Red = outputs L-signal 0V
- Colour yellow = Status Muting, WA

5.7.2 Optional accessories

Mounting kit MS-1110

Mounting kit consists of 2 steel angles and 4 spacers for central fixing

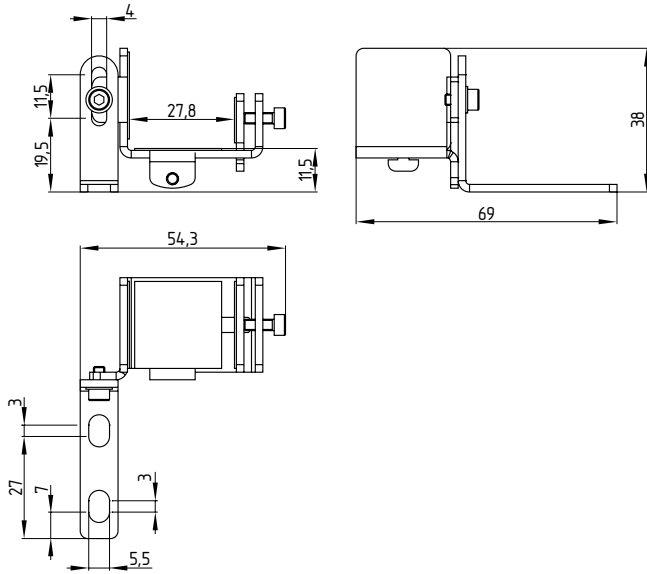

MSD5 spacer

The kit consists of 2 spacers. Available as of a protection zone height of 1050 mm. Mounting recommended in case of vibrations.

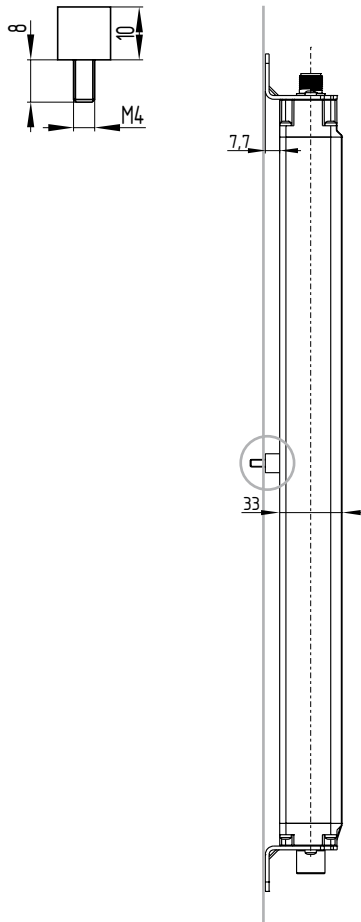

Connecting cable for transmitter

Item No	Designation	Description	Length
101207741	KA-0804	Female connector M12, 4-pole	5 m
101207742	KA-0805	Female connector M12, 4-pole	10 m
101207743	KA-0808	Female connector M12, 4-pole	20 m

Connecting cable for receiver (without MCU-02)

Item No	Designation	Description	Length
101213352	KA-0980	Female connector M12, 12-pole	5 m
101213353	KA-0981	Female connector M12, 12-pole	10 m

Connecting cable for receiver (with MCU-02)

Item No	Designation	Description	Length
101207728	KA-0904	Female connector M12, 8-pole	5 m
101207729	KA-0905	Female connector M12, 8-pole	10 m
101207730	KA-0908	Female connector M12, 8-pole	20 m

Adapter cable for parameter setting

Item No	Designation	Description	Length
103005575	KA-0976	Pushbutton with command device 2x female connectors M12, 12-pole	1 m

Muting sets

Item No	Designation	Description
103006073	MUT-SET-L-01	Muting set L-version for mounting to the assembly stand MST, set complete with 2 muting sensors, MCU-02, attachment and cable
103006074	MUT-SET-L-02	Muting set L-version for mounting to the sensor profile, set complete with 2 muting sensors, MCU-02, attachment and cable
103006075	MUT-SET-T-01	Muting set T-version for mounting to the assembly stand MST, set complete with 4 muting sensors, MCU-02, attachment and cable
103006076	MUT-SET-T-02	Muting set T-version for mounting to the sensor profile, set complete with 4 muting sensors, MCU-02, attachment and cable

Test rod PLS

The test rod is used for testing the protection field.

MSD4 Vibration damper

The MSD4 vibration damper kit is recommend to be used for damping vibrations and oscillations on the AOPD.

Kit consisting of: 8 vibration dampers 15 x 20 mm, 8 M5 cylinder head screws with hexagon socket, 8 spring washers. Mounting using mounting kit MS-1100.

Muting connection unit MCU-02

Muting connection unit with connecting cable for receiver M12, 12-pole, length 1.5 m

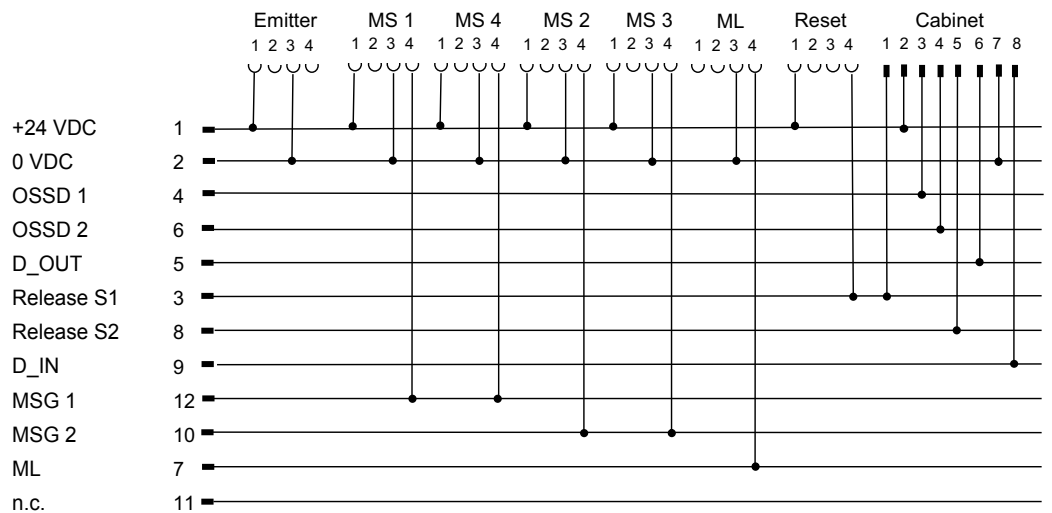

Connections	Designation	Description
7 x connector female M12, 4-pole	MS1	Muting sensor 1
	MS2	Muting sensor 2
1 x connector female M12, 8-pole	MS3	Muting sensor 3
	MS4	Muting sensor 4
	Emitter	Transmitter
	ML	Muting lamp
	Cabinet	Control cabinet
	Reset	Pushbutton release



When using the MCU-02 an M12 8 pin coupling is to be used for the connection to the control cabinet.



More accessories can be found at www.schmersal.net.

6. Electrical connection

6.1 Wiring example Muting

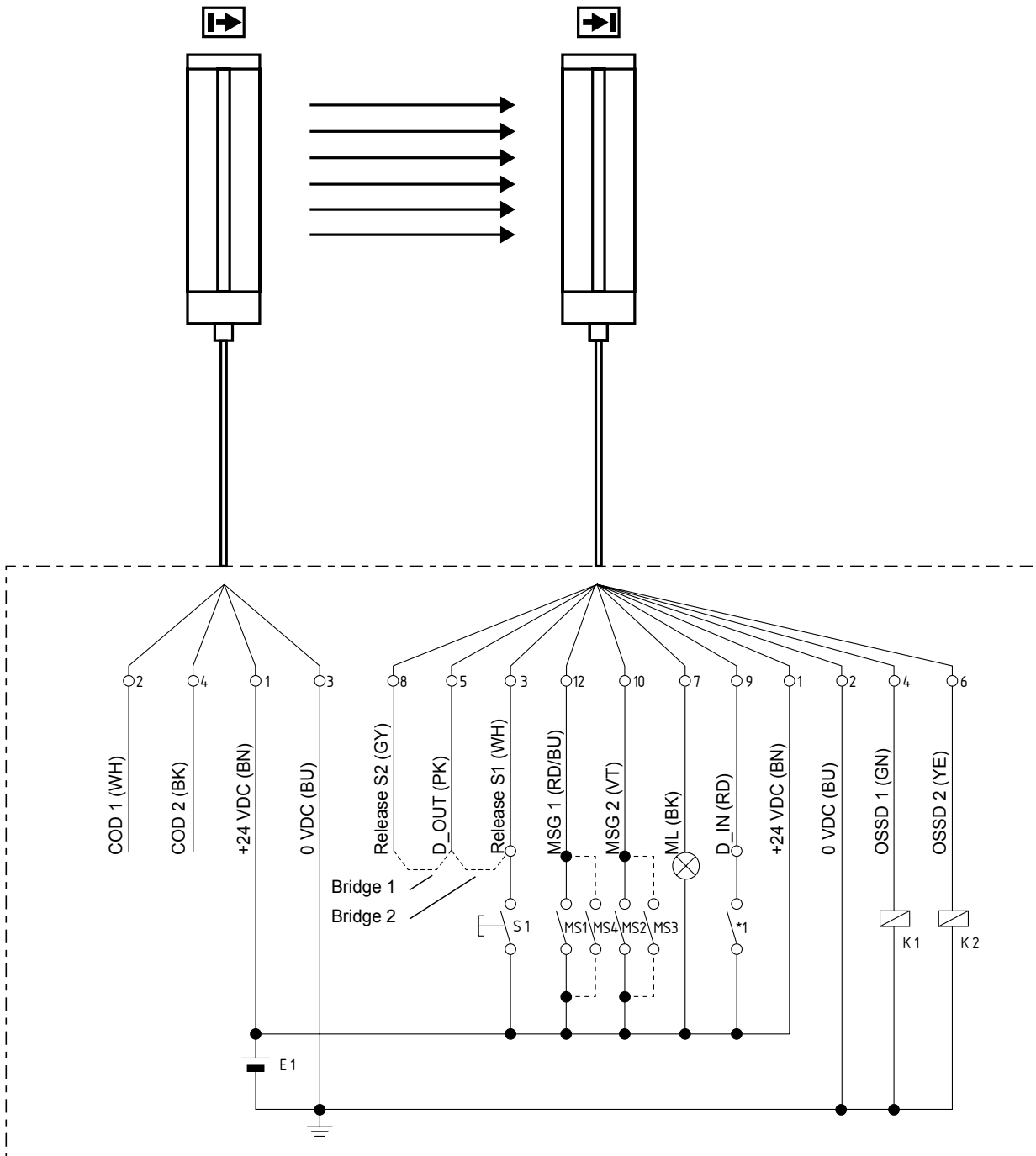

Restart interlock (manual reset) (bridge 1)

By bridging Restart 2 (pin 8) and D_OUT (pin 5), the restart interlock (manual reset) is activated. Connect S1 to pin 3.

Protective mode / Automatic active (bridge 2)

By bridging D_OUT (pin 5) and Release/Override (pin 3), the protective mode is activated. **Do not connect S1.**

K1, K2	Relay for processing the switching outputs OSSD 1, OSSD 2
S1	Command device button for enabling restart/override
E1	Power supply 24 VDC ± 10%
MS1-MS4	Muting sensors
ML	Muting lamp
MSG1	Muting sensor group 1
MSG2	Muting sensor group 2
*1	Connection possibility contactor control, muting enable, belt-stop

6.2 Wiring example cyclic function

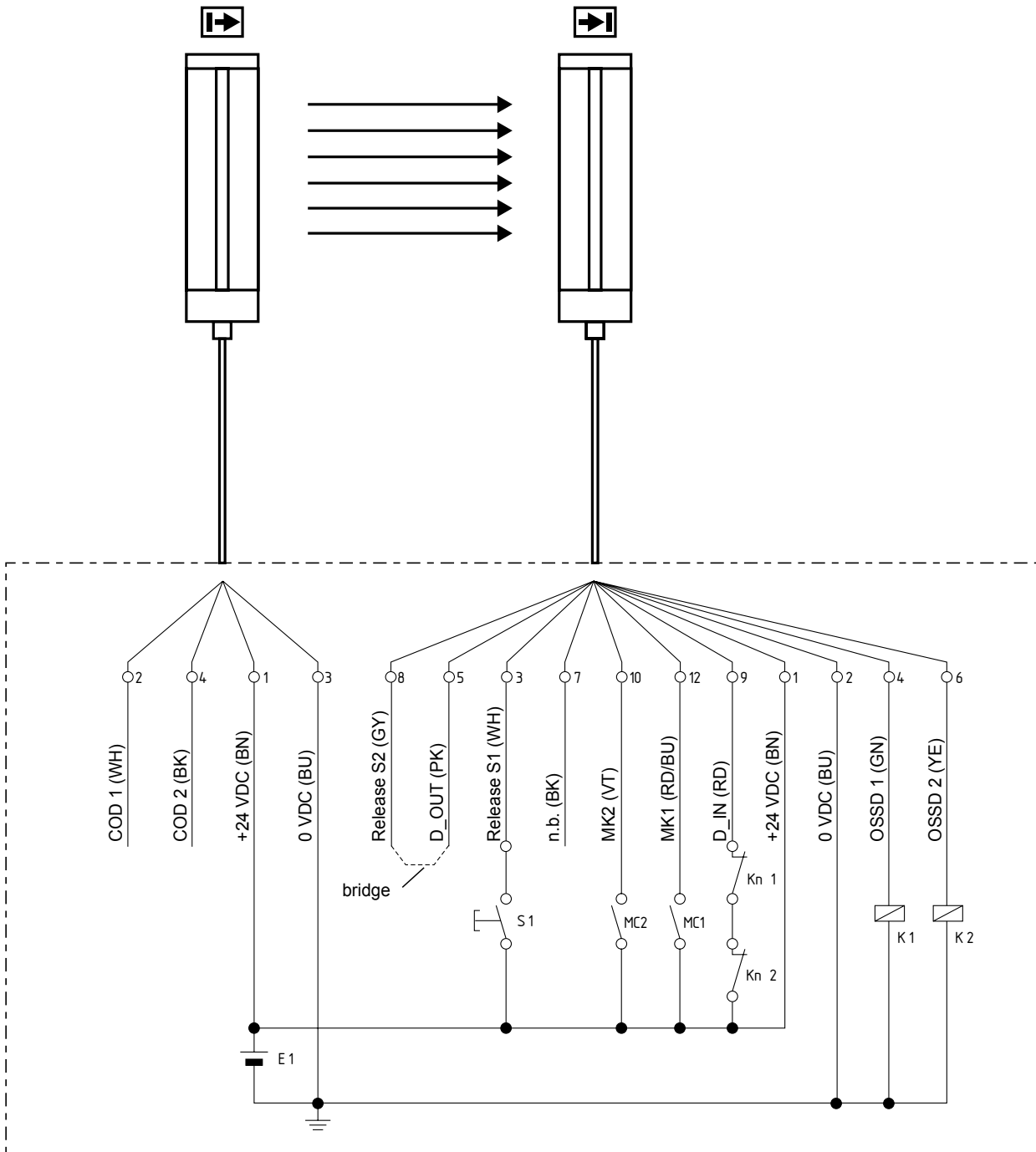

Restart interlock (manual reset) (bridge)

By bridging Restart 2 (pin 8) and D_OUT (pin 5), the restart interlock (manual reset) is activated. Connect S1 to pin 3.

K1, K2	Relay for processing the switching outputs OSSD 1, OSSD 2
S1	Command device for restart
E1	Power supply 24 VDC ± 10%
Kn1, Kn2	Auxiliary contacts of the last switching relay (optional) Signals at input EDM, only to be connected when the function is activated.
MC1	Machine contact 1
MC2	Machine contact 2
n.b.	not used

6.3 Connector configuration Receiver, Transmitter & Cable

6.3.1 Muting operation

RECEIVER

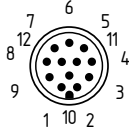
Cable	Signal	Description
M12 connector, 12 pole	Designation	Description
	1 BN	+24 VDC Power supply
	2 BU	0 VDC Power supply
	3 WH	Release S1 Input Release S1
	4 GN	OSSD 1 Safety output 1
	5 PK	D_OUT Operating mode
	6 YE	OSSD 2 Safety output 2
	7 BK	ML Muting lamp
	8 GY	Release S2 Input Release S2
	9 RD	D_IN Input EDM, belt-stop, muting enable
	10VT	MSG 2 Switching input muting sensor group MSG 2
	11 GY/PK	not used not used
12RD/BU	MSG 1 Switching input muting sensor group MSG 1	

Accessories - cable

M12 connector female, 12 pole

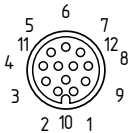

TRANSMITTER

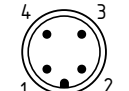
Cable	Signal	Description
M12 connector, 4 pole	Designation	Description
	1 BN	24 VDC Power supply
	2 WH	COD1 Coding 1
	3 BU	0 VDC Power supply
	4 BK	COD2 Coding 2

Accessories - cable

M12 connector female, 4 pole

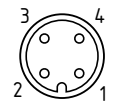

Connection MCU-02 to cabinet

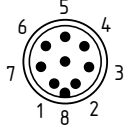
SLC: connector	Signal	Description
M12 / 8-pole	Designation	Description
	1 WH	Release S1 Input Release S1
	2 BN	+24 VDC Power supply
	3 GN	OSSD 1 Safety output 1
	4 YE	OSSD 2 Safety output 2
	5 GY	Release S2 Input Release S2
	6 PK	D_OUT Operating mode
	7 BU	0 VDC Power supply
	8 RD	D_IN Input EDM, belt-stop, muting enable

Cable: Connector female M12 / 8-pole

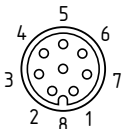

6.3.2 Cyclic operation

RECEIVER

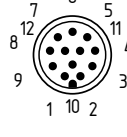
Cable	Signal	Description
M12 connector, 12 pole	Designation	Description
	1 BN	+24 VDC Power supply
	2 BU	0 VDC Power supply
	3 WH	Release S1 Input Release S1
	4 GN	OSSD 1 Safety output 1
	5 PK	D_OUT Operating mode
	6 YE	OSSD 2 Safety output 2
	7 BK	not used not used
	8 GY	Release S2 Input Release S2
	9 RD	D_IN Input EDM
	10VT	MK2 Machine contact 2
	11 GY/PK	not used not used
	12RD/BU	MK1 Machine contact 1

Accessories - cable

M12 connector female, 12 pole

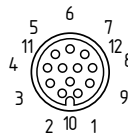

TRANSMITTER

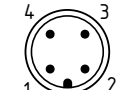
Cable	Signal	Description
M12 connector, 4 pole	Designation	Description
	1 BN	24 VDC Power supply
	2 WH	COD1 Coding 1
	3 BU	0 VDC Power supply
	4 BK	COD2 Coding 2

Accessories - cable

M12 connector female, 4 pole

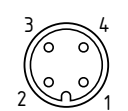

Connect COD 1 / COD 2 only when alternative beam coding is activated.



The colour codes are only valid for the cable types mentioned below "optional accessories".



For UL evaluated products we do recommend to use the UL style cable 20549.

6.4 Wiring example with safety-monitor module

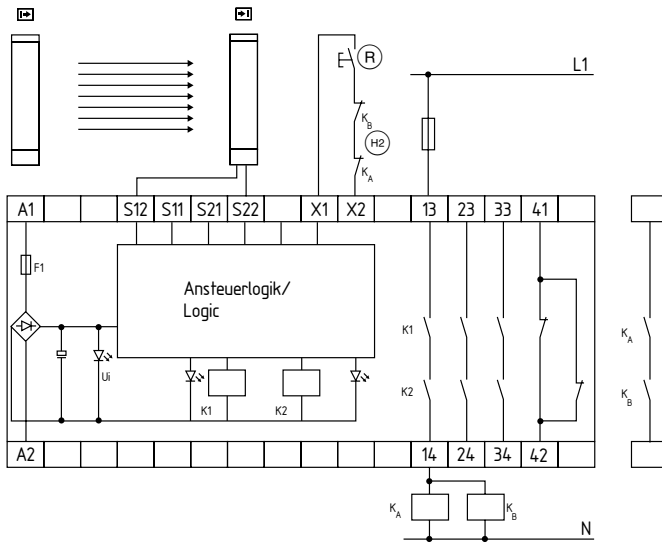

Key safety-monitoring module

- Contactor control K_A and K_B at X1/X2
- Command device \textcircled{R} Restart interlock restart at X1/X2
- OSSD outputs at S12 and S22
- QS-switch = nQS, deactivate cross-wire short detection

7. Set-up and maintenance

7.1 Check before start-up

Prior to start-up, the following items must be checked by the responsible person.

Wiring check prior to start-up

1. The voltage supply is a 24V direct current power supply (see technical specifications), which meets the CE Directives, Low Voltage Directives. A power downtime of 20 ms must be bridged.
2. Presence of a voltage supply with correct polarity at the AOPD.
3. The connecting cable of the transmitter is correctly connected to the transmitter and the connecting cable of the receiver correctly to the receiver.
4. The double insulation between the safety outputs of the AOPD and an external potential is assured.
5. The outputs OSSD1 and OSSD2 are not connected to +24 VDC.
6. The connected switching elements (load) are not connected to +24 VDC.
7. If two or more AOPDs are used within close range compared to each other, an alternating arrangement must be observed. Any mutual interference of the systems must be prevented.

Switch the AOPD on and check the operation.

7.2 Maintenance



Do not use the AOPD before the next inspection is terminated. An incorrect inspection can lead to serious and mortal injuries.

Conditions

For safety reasons, inspection results should be safely archived. The operating principle of the AOPD and the machine must be known in order to be able to conduct an inspection. The inspection and maintenance should only be carried out by authorised persons.

7.3 Regular check

A regular visual inspection and functional test, including the following steps, is recommended:

1. The component does not have any visible damages.
2. The optics cover is neither damaged or soiled
3. Hazardous machinery parts can only be accessed by passing through the protection zone of the AOPD.
4. The staff remains within the detection area, when works are conducted on hazardous machinery parts.
5. The safety distance to the point of danger exceeds the mathematically calculated distance.

Operate the machine and check whether the hazardous movement stops under the hereafter-mentioned circumstances.

1. Hazardous machine parts do not move when the protection field is interrupted.
2. The hazardous machine movement is immediately stopped, when the protection field is interrupted with the test rod immediately before the transmitter, immediately before the receiver and in the middle between the transmitter and the receiver.
3. No hazardous machine movement when the test rod is within the protection field.
4. The hazardous machine movement comes to standstill, when the voltage supply of the AOPD is switched off.

7.4 Half-yearly inspection

The following items must be checked every six months or when a machine setting is changed.

1. Machine stops or does not inhibit any safety function.
2. No machine modification or connection change, which affects the safety system, has taken place.
3. The outputs of the AOPD are correctly connected to the machine.
4. The total response time of the machine has not increased since the machine was commissioned.
5. The cables, the connectors, the caps and the mounting angles are in perfect condition.

7.5 Cleaning

If the optics cover of the sensors is extremely soiled, the OSSD outputs can be disabled. Clean the surface with a clean soft cloth. Do not apply any pressure. Do not use aggressive, abrasive or scratching cleaning agents.

8. Diagnostic

8.1 Status information LED

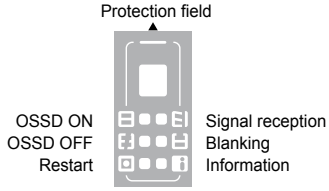
Receiver	Function	LED colour	Description
 <p>Protection field</p> <p>OSSD ON OSSD OFF Restart</p> <p>Signal reception Blanking Information</p>	OSSD ON	green	Safety outputs Signal condition ON
	OSSD OFF	red	Safety outputs Signal condition OFF
	Restart	yellow	AOPD expected release signal
	Signal reception	orange	Signal strength is too low
	Blanking	blue	Protection zones are inactive (object blanking)
	Information	yellow-green	Alternative beam coding, muting, cyclic operation

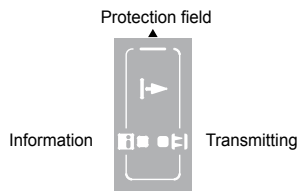





Transmitter	Function	LED colour	Description
 <p>Protection field</p> <p>Information</p> <p>Transmitting</p>	Information	green	Function display alternative beam coding
	Transmitting	orange	Transmitter active

Receiver LED	Status LED	Description
OSSD ON	On	Protection field clear
OSSD OFF	On	Protection field interrupted, system or configuration error
	On	Error output refer to Fault diagnostic table
Restart	On	Restart interlock active, signal expected at restart input
Signal reception	ON/flashing	Signal reception too low, check alignment and installation height between transmitter and receiver
		Cleaning the black profile cover
	OFF	Alignment between transmitter and receiver OK, when the OSSD are enabled
Blanking	1 flash	Changeable object blanking of protection zone(s)
	2 flash	Changeable object blanking. 1 beam
	3 flash	Changeable object blanking. 2 beams
	4 flash	Changeable object blanking with one additional beam
	5 flash	Changeable object blanking with two additional beams
	6 flash	Changeable object blanking with moveable edge region
Information	1 flash	Alternative beam coding is active
	2 flash	Muting function is active
	3 flash	Cyclic operation is active
	4 flash	Muting function with alternative beam coding
	5 flash	Cyclic operation with alternative beam coding
	OFF	Beam coding (standard) is active

Transmitter LED	Status LED	Description
Transmitting	On	Standard operation, transmitter active
	flashing	Configuration error
Information	flashing	Alternative beam coding is active

8.2 Fault diagnostic

The AOPD carries out a self-test after the power supply has been applied. If a malfunction is detected the AOPD switches to the OFF state and repeatedly issues the fault number (e.g. E1)

Status display	Fault feature	Action
	Wiring error, operating mode not defined (automatic or restart mode)	Check all connections at the receiver, Jumper connection 1 or jumper connection 2 present?
	Supply voltage	UB = 24V/DC+/- 10%, check voltage source and primary voltage, note: after the fault message E2 has been displayed three times, a reset is executed.
	Error output(s), OSSD1 or OSSD2	Check the connections of both outputs, short-circuit of both OSSD, connection to level 0V or 24V, deactivate external (relay) cross-wire short monitoring.
	Contactor control (EDM)	EDM active: check connections of both NC contacts, EDM not active: check level at Pin 8, input not switched.
	Beam blanking	Check the blanking area(s) of fixed or floating objects with the selected parameter setting, fault elimination - repeat configuration in the parameter setting, possibly adjust P 1, P 2, P 3.
	Configuration error in parameter setting	Check parameter setting and save/accept with "S." or delete/reset with "C."
	System error	Restart the system, if E 7 display continues, exchange components.

The error display is reset after elimination of the error cause and after the receiver has been switched back on. The error indication displays a 3-digit system error code for every 10th display.

9. Disassembly and disposal

9.1 Disassembly

The safety switchgear must be disassembled in a de-energised condition only.

9.2 Disposal

The safety switchgear must be disposed of in an appropriate manner in accordance with the national prescriptions and legislations.

10. Appendix

10.1 Contact

Consultancy / Sales



K. A. Schmersal GmbH & Co. KG
 Möddinghofe 30
 D-42279 Wuppertal
 Phone +49 (0) 202 64 74 -0
 Fax +49 (0) 202 64 74- 100

You will also find detailed information regarding our product variety on our website: www.schmersal.com

Repair handling / shipping

Safety Control GmbH
 Am Industriepark 11
 D-84453 Mühldorf / Inn
 Phone +49 (0) 8631-18796-0
 Fax +49 (0) 8631-18796-1

11. EU Declaration of conformity

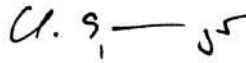
EU Declaration of conformity			
Original	Safety Control GmbH Am Industriepark 33 84453 Mühldorf / Inn Germany		
We hereby certify that the hereafter described components both in their basic design and construction conform to the applicable European Directives.			
Name of the component:	SLC445 SLG445		
Type:	See ordering code		
Description of the component:	Safety light curtain / safety light grid		
Relevant Directives:		Valid up to	Valid as of
		April 19, 2016	April 20, 2016
	Machinery Directive	2006/42/EC	2006/42/EC
	EMC-Directive	2004/108/EC	2014/30/EU
	RoHS-Directive	2011/65/EU	2011/65/EU
Applied standards:	EN 61496-1:2004 + A1:2008, CLS/TS 61496-2:2006, EN ISO 13849-1:2008 + AC:2009, EN 62061:2005 + A1:2013		
Notified body for the prototype test:	TÜV NORD CERT GmbH Langemarckstr. 20, 45141 Essen ID n°: 0044		
EC-prototype test certificate:	44 205 13144604		
Person authorized for the compilation of the technical documentation:	Oliver Wacker Möddinghofe 30 42279 Wuppertal		
Place and date of issue:	Mühldorf, February 24, 2016		
SLC-SLG445-B-EN			
	Authorised signature Klaus Schuster Managing Director	Authorised signature Christian Spranger Managing Director	



The currently valid declaration of conformity can be downloaded from the internet at www.schmersal.net.



K. A. Schmersal GmbH & Co. KG
Möddinghofe 30, D - 42279 Wuppertal
Postfach 24 02 63, D - 42232 Wuppertal

Phone: +49 - (0)2 02 - 64 74 - 0
Telefax: +49 - (0)2 02 - 64 74 - 1 00
E-Mail: info@schmersal.com
Internet: <http://www.schmersal.com>