



EN Operating instructions.pages 1 to 6
Translation of the original operating instructions

Content

1 About this document

1.1 Function 1

1.2 Target group: authorised qualified personnel. 1

1.3 Explanation of the symbols used 1

1.4 Appropriate use 1

1.5 General safety instructions 1

1.6 Warning about misuse 2

1.7 Exclusion of liability 2

2 Product description

2.1 Ordering code 2

2.2 Special versions 2

2.3 Destination and use 2

2.4 Technical data 2

2.5 Safety classification 2

3 Mounting

3.1 General mounting instructions 3

3.2 Dimensions 3

3.3 Axial misalignment 4

3.4 Adjustment 4

4 Electrical connection

4.1 General information for electrical connection. 4

4.2 Contact variants 4

4.3 Connection 4

5 Set-up and maintenance

5.1 Functional testing 4

5.2 Maintenance 4

6 Disassembly and disposal

6.1 Disassembly 4

6.2 Disposal 4

7 Appendix

7.1 EC Declaration of conformity 5

1. About this document

1.1 Function

This operating instructions manual provides all the information you need for the mounting, set-up and commissioning to ensure the safe operation and disassembly of the safety switchgear. The operating instructions must be available in a legible condition and a complete version in the vicinity of the device.

1.2 Target group: authorised qualified personnel

All operations described in this operating instructions manual must be carried out by trained specialist personnel, authorised by the plant operator only.

Please make sure that you have read and understood these operating instructions and that you know all applicable legislations regarding occupational safety and accident prevention prior to installation and putting the component into operation.

The machine builder must carefully select the harmonised standards to be complied with as well as other technical specifications for the selection, mounting and integration of the components.

1.3 Explanation of the symbols used



Information, hint, note:

This symbol is used for identifying useful additional information.



Caution: Failure to comply with this warning notice could lead to failures or malfunctions.

Warning: Failure to comply with this warning notice could lead to physical injury and/or damage to the machine.

1.4 Appropriate use

The products described in these operating instructions are developed to execute safety-related functions as part of an entire plant or machine. It is the responsibility of the manufacturer of a machine or plant to ensure the correct functionality of the entire machinery or plant.

The safety switchgear must be exclusively used in accordance with the versions listed below or for the applications authorised by the manufacturer. Detailed information regarding the range of applications can be found in the chapter "Product description".

1.5 General safety instructions

The user must observe the safety instructions in this operating instructions manual, the country-specific installation standards as well as all prevailing safety regulations and accident prevention rules.



Further technical information can be found in the Schmersal catalogues or in the online catalogue on the Internet: www.schmersal.net.

The information contained in this operating instructions manual is provided without liability and is subject to technical modifications.



If multiple safety components are wired in series, the Performance Level to EN ISO 13849-1 will be reduced due to the restricted error detection under certain circumstances. The entire concept of the control system, in which the safety component is integrated, must be validated to EN ISO 13849-2.

There are no residual risks, provided that the safety instructions as well as the instructions regarding mounting, commissioning, operation and maintenance are observed.

1.6 Warning about misuse



In case of inadequate or improper use or manipulations of the safety switchgear, personal hazards or damage to machinery or plant components cannot be excluded. The relevant requirements of the standard EN 1088 must be observed.

1.7 Exclusion of liability

We shall accept no liability for damages and malfunctions resulting from defective mounting or failure to comply with this operating instructions manual. The manufacturer shall accept no liability for damages resulting from the use of unauthorised spare parts or accessories.

For safety reasons, invasive work on the device as well as arbitrary repairs, conversions and modifications to the device are strictly forbidden; the manufacturer shall accept no liability for damages resulting from such invasive work, arbitrary repairs, conversions and/or modifications to the device.

2. Product description

2.1 Ordering code

This operating instructions manual applies to the following types:

EX-BNS40S-12Z^①-②-3GD

No.	Option	Description
①		without LED
	G	with LED
②		Through-holes
	C	Rear-side threaded hole
Actuator		BPS40S-1, BPS40S-2, BPS40S-1-C, BPS40S-2-C

2.2 Special versions

For special versions, which are not listed in the order code below 2.1, these specifications apply accordingly, provided that they correspond to the standard version.

2.3 Destination and use

The safety sensor is designed for application in safety circuits and is used for monitoring the position of movable safety guards to EN 1088 and EN 60947-5-3. The safety sensor can be used for monitoring the position of movable guards and flaps in explosion-endangered areas of Zone 2 and 22 category 3GD. The installation and maintenance requirements to the standard series EN 60079 must be met. The safety switches are used for applications, in which the hazardous situation is terminated without delay when the safety guard is opened. To actuate the safety sensors, only the above-mentioned actuators can be used.

Only the entire system consisting of the safety sensor, the actuator and the safety-monitoring module meets the requirements of the standard EN 60947-5-3.

The safety sensor is especially suitable for food-processing machinery and plants. Due to the stainless steel enclosure, the safety sensor is resistant to corrosion and cleaning agents. The safety sensor is suitable for concealed mounting behind non-ferromagnetic covers.



Information for the selection of suitable safety-monitoring modules can be found in the Schmersal catalogues or in the online catalogue on the Internet: www.schmersal.net.

Technically, multiple safety sensors can be wired to one AES/SRB safety-monitoring module. To connect multiple safety sensors (check if authorised!), their NO contacts are wired in parallel and their NC contacts in series. The Protect-IE-11 or -02 or PROTECT-PE-11 (-AN) or -02 input expander module can be used to connect up to 4 safety sensors with NC/NC or NC/NO contacts.

Safety sensors equipped with LED's shall not be wired in series, except for the Protect-IE input expander module. As a result of this, the luminosity of the LED's would considerably decrease and the voltage could drop below the minimum input voltage of the downstream safety-monitoring module. Please observe that the diagnostic coverage could reduce if multiple safety sensors are connected to one safety-monitoring module.



The energy restriction for LED versions (24 V/10 mA) must be ensured by the user.



In case of series-wiring at SRB max. 1 sensor with LED indication for U_N .

2.4 Technical data

Equipment category:	⊕ II 3GD
Ex protection:	Ex nAnC IIC T6 Gc; Ex t IIIC T80 °C Dc
Standards:	IEC 60947-5-3, BG-GS-ET-14, EN 60079-0, EN 60079-15, EN 60079-31
Design:	rectangular
Enclosure:	V4A stainless steel to DIN 1.3960
Max. impact energy:	7 J
Protection class:	IP65 / IP67 to IEC/EN 60529
termination:	LIYY cable, 1 m (food safe)
Cable section:	6 × 0.25 mm ²
Operating principle:	magnetic
Actuating magnet:	BPS40S-1, BPS40S-2, BPS40S-1-C, BPS40S-2-C, codiert
S_{a0} :	8 mm
S_{a1} :	18 mm
Switching condition indication:	LED only with ordering suffix G
Switching voltage:	max. 24 VAC/DC
Switching current:	
- without LED:	max. 250 mA
- with LED:	max. 10 mA
Switching capacity:	
- without LED:	max. 3 W
- with LED:	max. 240 mW
Required short-circuit current:	100 A
Ambient temperature:	-20 °C ... +60 °C
Storage and transport temperature:	-25 °C ... +80 °C
Switching frequency:	max. 5 Hz
Resistance to shock:	30 g / 11 ms
Resistance to vibration:	10 ... 55 Hz, amplitude 1 mm

2.5 Safety classification

Standards:	EN ISO 13849-1
B_{10d} (NC/NO contact):	25.000.000
notice:	at 20% contact load
Service life:	20 years

$$MTTF_d = \frac{B_{10d}}{0,1 \times n_{op}} \quad n_{op} = \frac{d_{op} \times h_{op} \times 3600 \text{ s/h}}{t_{cycle}}$$

(Specifications can vary depending on the application-specific parameters h_{op} , d_{op} and t_{cycle} as well as the load.)

3. Mounting

3.1 General mounting instructions

- Fitting is only authorised in a de-energised condition.
- Do not use the sensor and the actuator as a mechanical backstop.
- Any mounting position, provided that the active surfaces are opposite.
- Inseparably fix the sensor and the actuator to the safety guard.
- Do not install the safety sensor and the actuator in strong magnetic fields.
- If possible, do not mount the sensor and the actuator on ferromagnetic material. When the sensor and the actuator are installed on ferromagnetic material, variations can be expected in the limit distances. The use of a non-magnetic spacer of at least 5 mm thick must be used. The use of non-magnetic fixing screws is recommended also.
- Do not subject the safety sensor and actuator to extreme vibrations and shocks.
- Keep away from metal chips.
- The mounting distance between two sensors should always be at least 50 mm.



Also suitable for concealed mounting behind non-ferromagnetic covers.

3.2 Dimensions

All measurements in mm.

EX-BNS40S safety sensor

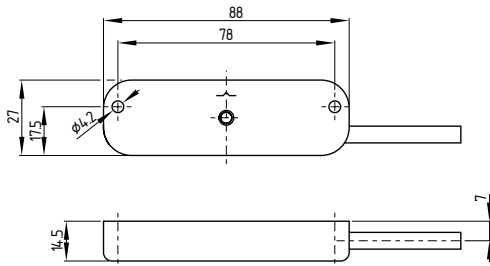

EX-BNS40S-...-C safety sensor

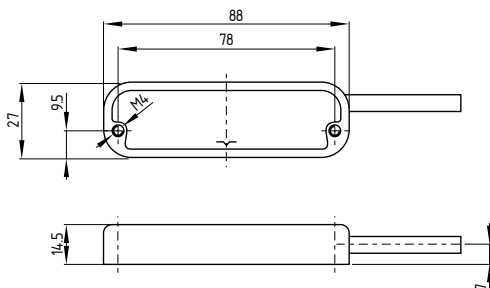

BPS40S-1 Actuator

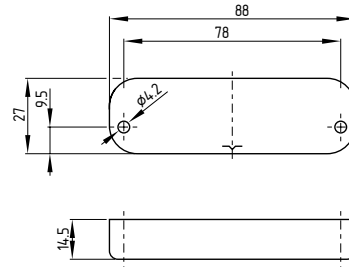

BPS40S-2 Actuator

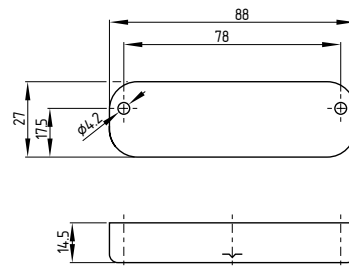

BPS40S-1-C Actuator

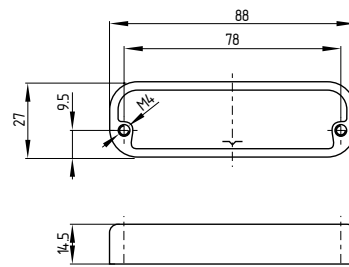

BPS40S-2-C Actuator

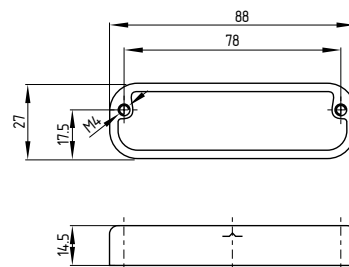

3.3 Axial misalignment

A horizontal and vertical misalignment of the safety sensor and the actuator is tolerated. The possible misalignment depends on the distance of the active surface of the safety sensor and the actuator. The safety sensor remains active within the tolerance range.

The specified switching distances refer to oppositely mounted safety sensors and actuators.

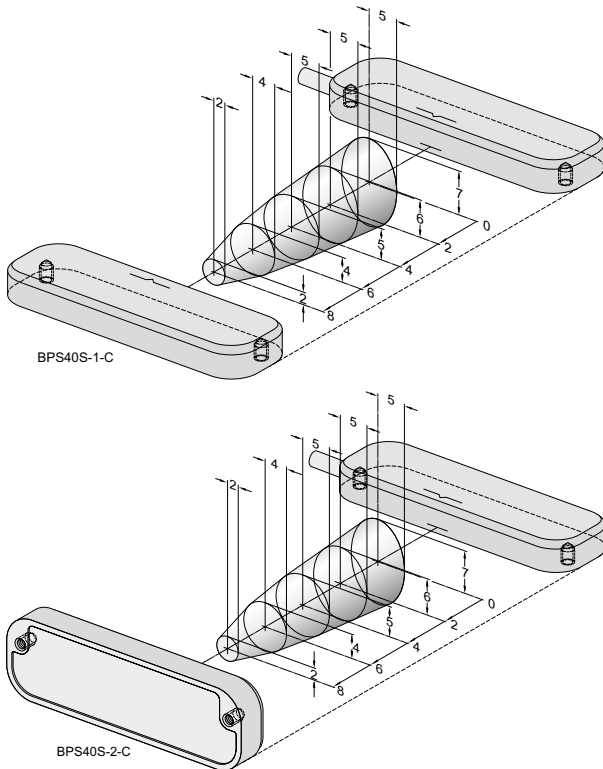

assured switching distance: $s_{ao} = 8 \text{ mm}$
 assured switch-off distance: $s_{ar} = 18 \text{ mm}$

3.4 Adjustment

Align the central markings of the safety sensor and the actuator with each other. The LED can only be used as rough setting tool. The correct functionality of both safety channels must be checked by means of the connected safety-monitoring module.

4. Electrical connection

4.1 General information for electrical connection



The electrical connection may only be carried out by authorised personnel in a de-energised condition.

The safety sensors must be wired in accordance with the specified wire colours.



On the basis of the maximum switching voltage 24 VAC/DC, the safety sensor has a double or reinforced insulation in accordance with EN 60079-0 (paragraph 15.2, devices that do not require an earth connection).

4.2 Contact variants

The contact position shows the actuated sensor function when the safety guard is closed. For safety sensors with LED, the LED is illuminated when the safety guard is closed. The contact configurations of the versions with or without LED are identical.

GY S13 — S14 PK
 GN S21 — S22 YE
 WH S31 — S32 BN

4.3 Connection

The safety sensor is suitable for use in conjunction with safety-monitoring modules, which are controlled through NO/NC safety inputs or NC/NC safety inputs.

In these versions, the optional LED is integrated in the S21-S22 circuit.

Connection to safety-monitoring modules with NO/NC inputs:

NO contacts: S13 - S14 to the NO input of the safety-monitoring module (AES safety-monitoring module: terminal S13 - S14)

NC contacts: S21 - S22 at the NC input S21 - S22 of the safety-monitoring module (AES safety-monitoring module: terminal S21 - S22)

NC contacts: S31 - S32 can be used as signalling contact

Connection to safety-monitoring modules with NC/NC inputs:

NC contacts: S21 - S22 at the 1st NC input safety-monitoring module (AES safety-monitoring module: terminal S11 - S12)

NC contacts: S31 - S32 at the 2nd NC input safety-monitoring module (AES safety-monitoring module: terminal S21 - S22)

NO contacts: S13 - S14 can be used as signalling contact

5. Set-up and maintenance

5.1 Functional testing

The safety function of the safety components must be tested. The following conditions must be previously checked and met:

1. Fitting of the sensor and the actuator.
2. Fitting and integrity of the power cable.
3. The system is free of dirt and soiling (in particular metal chips).

5.2 Maintenance

In the case of correct installation and adequate use, the safety sensor features maintenance-free functionality.

A regular visual inspection and functional test, including the following steps, is recommended:

1. Check of the safety function
 - Check the fitting of the sensor and the actuator.
 - Remove possible metal chips.
 - Check the cable for damage.

Damaged or defective components must be replaced.

6. Disassembly and disposal

6.1 Disassembly

The safety switchgear must be disassembled in a de-energised condition only.

6.2 Disposal

The safety switchgear must be disposed of in an appropriate manner in accordance with the national prescriptions and legislations.

7. Appendix

7.1 EC Declaration of conformity

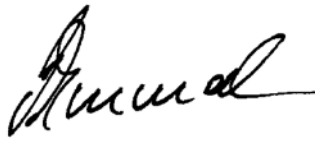
	
<h2>EC Declaration of conformity</h2>	
Translation of the original declaration of conformity	K. A. Schmersal GmbH & Co. KG Industrielle Sicherheitssysteme Möddinghofe 30, 42279 Wuppertal Germany Internet: www.schmersal.com
We hereby certify that the hereafter described safety components both in its basic design and construction conform to the applicable European Directives.	
Name of the safety component:	EX-BNS40S ⊕ Ex nAnC IIC T6 Gc ⊕ Ex t IIIC T80 °C Dc
Type:	Refer to ordering code
Description of the safety component:	Coded safety-sensor with magnetic operating principle in combination with the AES / SRB safety-monitoring modules from Schmersal or an equivalent safety-oriented control system fulfilling the requirements of the IEC 60947-5-3.
Harmonised EC-Directives:	2006/42/EC-EC-Machinery Directive 94/9/EC EC-Explosion Protection Directive (ATEX)
Used harmonized standards:	EN 60079-0, EN 60079-15, EN 60079-31
Person authorized for the compilation of the technical documentation:	Oliver Wacker Möddinghofe 30 42279 Wuppertal
Notified body, which approved the full quality assurance system, referred to in Appendix X, 94/9/EC:	TÜV Rheinland Industrie Service GmbH Am Grauen Stein, 51105 Köln ID n°.: 0035, Certification-n°.: 01 220 4316/02
Place and date of issue:	Wuppertal, September 3, 2012
EX-BNS40S-A-EN	
	Authorised signature Philip Schmersal Managing Director



The currently valid declaration of conformity can be downloaded from the internet at www.schmersal.net.



K. A. Schmersal GmbH & Co. KG
Industrielle Sicherheitssysteme
Möddinghofe 30, D - 42279 Wuppertal
Postfach 24 02 63, D - 42232 Wuppertal

Phone +49 - (0)2 02 - 64 74 - 0
Telefax +49 - (0)2 02 - 64 74 - 1 00
E-Mail: info@schmersal.com
Internet: <http://www.schmersal.com>