



2D vision
CVS, CVS2, CVS2

CVS2-P122



Model Name > CVS2-P122
Part No. > 1027333



At a glance

- Color inspection and sorting on large fields of view
- Inspecting one color, minimum and maximum fill
- 2-color matching
- Sorting up to 15 colors
- Reference capacity of 15 color configurations
- Parameter up- and download to PC
- Compact IP-67 rated housing with integrated display for configuration and monitoring
- Different variants for different fields of view and working distances

Your benefits

- The support for large fields of view ensures reliable color sorting even if your part varies in position
- The minimum and maximum fill tolerance ensures you that there is always correct fill of color on your part before it leaves your line
- The 2-color matching ensures you reliable result on multi- colored objects
- The reference capacity of 15 color configurations gives you the most economic solution for batch production
- Store and restore the configuration from PC will save you time in every repetitive machine installation



Features

Task:	Inspection
Technology:	2D Image analysis Snapshot Color
Toolset:	2-color match Color inspection Color sort
Focus:	Fixed focus
Sensor:	CMOS matrix sensor, color values
Sensing distance:	90 mm ... 150 mm
Spectral range:	Ca. 400 nm ... 750 nm
LED class:	Risk group 1 (low risk, IEC62471 : 2006)
Offline support:	Configuration
Sensor resolution:	208 px x 236 px x 3 px (RGB)

Internal lighting: White

Performance

Maximum performance: 200 fps
Typical performance: 38 fps
Number of inspections: 1

Interfaces

Operator interfaces: External display or integrated display
Digital inputs: HIGH (corresp. 8 V)
Configurable inputs: Reference object selection
External trigger
Digital outputs: PNP
Configurable outputs: Sorting, Auxiliary
Output current: < 100 mA
Default outputs: Inspection passed
Serial (RS-232): 1
Ethernet: -
Control elements: 5 buttons (setup)
Configuration software: CVS device software, CVS2 Dataloader (PC)

Mechanics/electronics

Connectors: HRS, 6-pin (external lighting/monitor)
Cable, 8-wire, 2 m (I/O, power)
Power consumption: < 220 mA Without output load (at 24 V)
Ripple: < 5 Vpp
Enclosure rating: IP 67
Housing material: ABS, Acryl glass, Polycarbonate
Dimensions (L x W x H): 95 mm x 42 mm x 34 mm
Optics: Integrated
Weight: 180 g

Ambient data

Ambient operating temperature¹⁾: 0 °C ... +40 °C
Ambient storage temperature²⁾: -20 °C ... +70 °C

^{1) 2)} Relative humidity: 35 % ... 85 %, 95 % at storage

Dimensional drawing

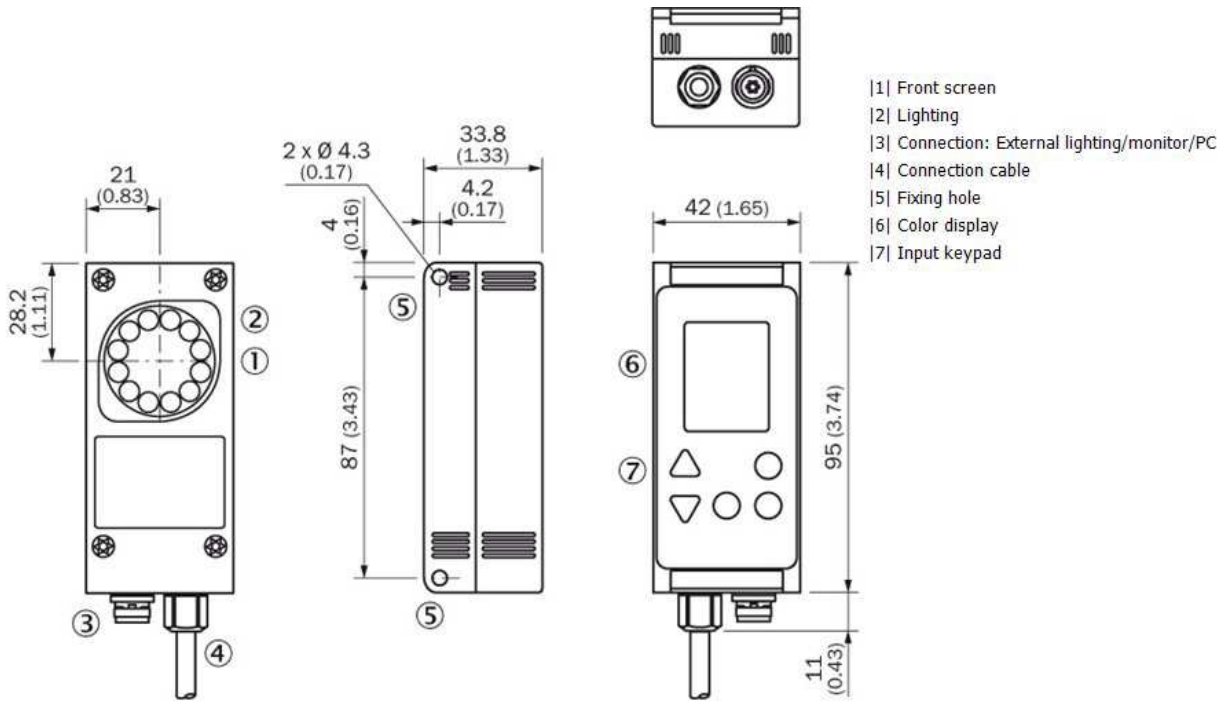

Adjustment possible

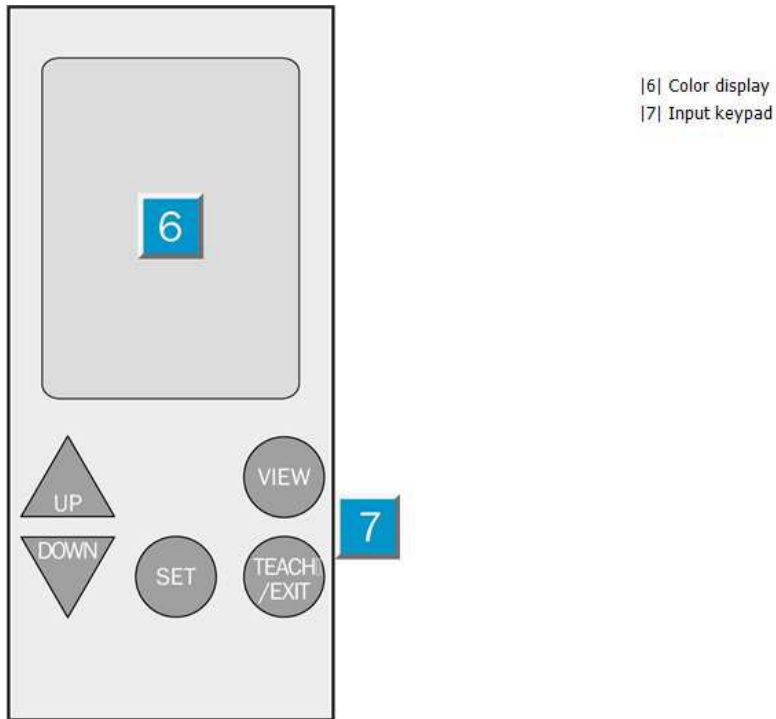

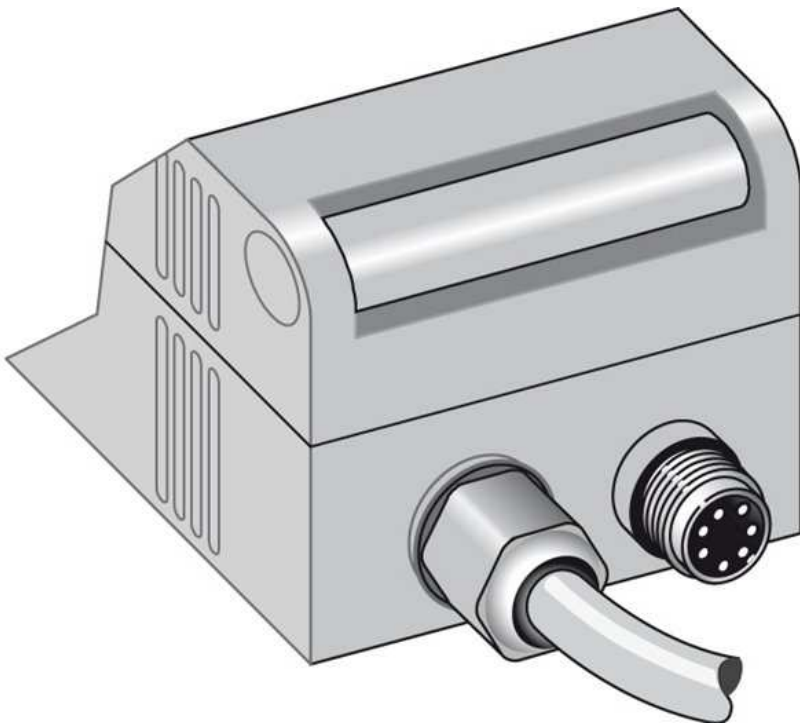

Australia

Phone +61 3 9457 0600
1800 33 48 02 – tollfree
E-Mail sales@sick.com.au

Belgium/Luxembourg

Phone +32 (0)2 466 55 66
E-Mail info@sick.be

Brasil

Phone +55 11 3215-4900
E-Mail marketing@sick.com.br

Canada

Phone +1 905 771 14 44
E-Mail information@sick.com

Česká republika

Phone +420 2 57 91 18 50
E-Mail sick@sick.cz

China

Phone +86 4000 121 000
E-Mail info.china@sick.net.cn
Phone +852-2153 6300
E-Mail ghk@sick.com.hk

Danmark

Phone +45 45 82 64 00
E-Mail sick@sick.dk

Deutschland

Phone +49 211 5301-301
E-Mail info@sick.de

España

Phone +34 93 480 31 00
E-Mail info@sick.es

France

Phone +33 1 64 62 35 00
E-Mail info@sick.fr

Great Britain

Phone +44 (0)1727 831121
E-Mail info@sick.co.uk

India

Phone +91-22-4033 8333
E-Mail info@sick-india.com

Israel

Phone +972-4-6881000
E-Mail info@sick-sensors.com

Italia

Phone +39 02 27 43 41
E-Mail info@sick.it

Japan

Phone +81 (0)3 5309 2112
E-Mail support@sick.jp

Magyarország

Phone +36 1 371 2680
E-Mail office@sick.hu

Nederland

Phone +31 (0)30 229 25 44
E-Mail info@sick.nl

Norge

Phone +47 67 81 50 00
E-Mail sick@sick.no

Österreich

Phone +43 (0)22 36 62 28 8-0
E-Mail office@sick.at

Polska

Phone +48 22 837 40 50
E-Mail info@sick.pl

România

Phone +40 356 171 120
E-Mail office@sick.ro

Russia

Phone +7-495-775-05-30
E-Mail info@sick.ru

Schweiz

Phone +41 41 619 29 39
E-Mail contact@sick.ch

Singapore

Phone +65 6744 3732
E-Mail sales.gsg@sick.com

Slovenija

Phone +386 (0)1-47 69 990
E-Mail office@sick.si

South Africa

Phone +27 11 472 3733
E-Mail info@sickautomation.co.za

South Korea

Phone +82 2 786 6321/4
E-Mail info@sickkorea.net

Suomi

Phone +358-9-25 15 800
E-Mail sick@sick.fi

Sverige

Phone +46 10 110 10 00
E-Mail info@sick.se

Taiwan

Phone +886 2 2375-6288
E-Mail sales@sick.com.tw

Türkiye

Phone +90 (216) 528 50 00
E-Mail info@sick.com.tr

United Arab Emirates

Phone +971 (0) 4 88 65 878
E-Mail info@sick.ae

USA/México

Phone +1(952) 941-6780
1 (800) 325-7425 – tollfree
E-Mail info@sickusa.com

More representatives and agencies
at www.sick.com