



Photoelectric sensors  
W260, Through-beam photoelectric sensor

WS/WE260-R270



**Model Name** > [WS/WE260-R270](#)  
**Part No.** > [6020774](#)



*Illustration may differ*

**At a glance**

- Long sensing ranges
- Mounting brackets for sender and receiver are included with delivery
- Selectable operation mode (light/dark)
- Optional time stages
- M12 connector or terminal chamber
- Versions for 10 - 30 V DC or 12 - 240 V DC/ 24 – 240 V AC voltage supply

**Your benefits**

- High operating reserve provides increased reliability
- Configuration controls are protected by a cover, ensuring less damage and a longer service life
- Easily accessible terminal chamber for electrical connections simplifies installation
- Simplified integration due to mounting compatibility since variants for DC or DC/AC voltage supply are available in the same design



**Features**

Sensor/detection principle:	Through-beam photoelectric sensor
Dimensions (W x H x D):	25 mm x 78 mm x 63 mm
Housing design (light emission):	Rectangular
Sensing range max.:	0 m ... 45 m
Sensing range:	0 m ... 40 m
Type of light:	Visible red light
Light source:	LED <sup>1)</sup>
Time type:	Off delay, On delay
Delay time:	Adjustable via time control, Adjustable via time delay selector switch, 0.1 s, 10 s
Angle of dispersion:	Ca. 1 °
Adjustment:	Potentiometer, 270 °
Light spot size (distance):	Ø 700 mm (40 m)

<sup>1)</sup> Average service life of 100,000 h at T<sub>A</sub> = +25 °C

**Mechanics/electronics**

Supply voltage::	12 V DC ... 240 V DC, 24 V AC ... 240 V AC <sup>1) 2)</sup>
Power consumption, sender:	≤ 4 VA
Power consumption, receiver:	≤ 5 VA

Output type:	Relay, electrically isolated <sup>3)</sup>
Output function:	Change-over contacts
Switching mode:	Light switching <sup>4)</sup>
Switching current (switching voltage):	3 A (240 V AC), 3 A (30 V DC)
Response time:	≤ 20 ms
Switching frequency:	25 Hz <sup>5)</sup>
Angle of reception:	Ca. 20 °
Electrical connection:	Cable gland
Circuit protection::	A, C <sup>6)</sup> <sup>7)</sup>
Protection class:	II <sup>8)</sup>
Weight:	120 g
Interference emission:	Level EN 61000-6-3 Residential and commercial areas
Optics material:	PC
Enclosure rating:	IP 67
Items supplied:	Mounting bracket BEF-W260
Usage category:	AC-15, DC-13, According to EN 60947-1
Ambient temperature operation:	-25 °C ... +55 °C
Ambient storage temperature:	-40 °C ... +70 °C
UL File No.:	EN50081-1, 242356
Housing material:	ABS, Plastic

1) <sup>2)</sup> ±10 % <sup>3)</sup> <sup>4)</sup> Provide suitable spark suppression for inductive or capacitive loads <sup>5)</sup> With light/dark ratio 1:1 <sup>6)</sup> A = V <sub>S</sub> connections reverse-polarity protected <sup>7)</sup> C  
= interference suppression <sup>8)</sup> Rated voltage: 250 V AC/DC

### Dimensional drawing

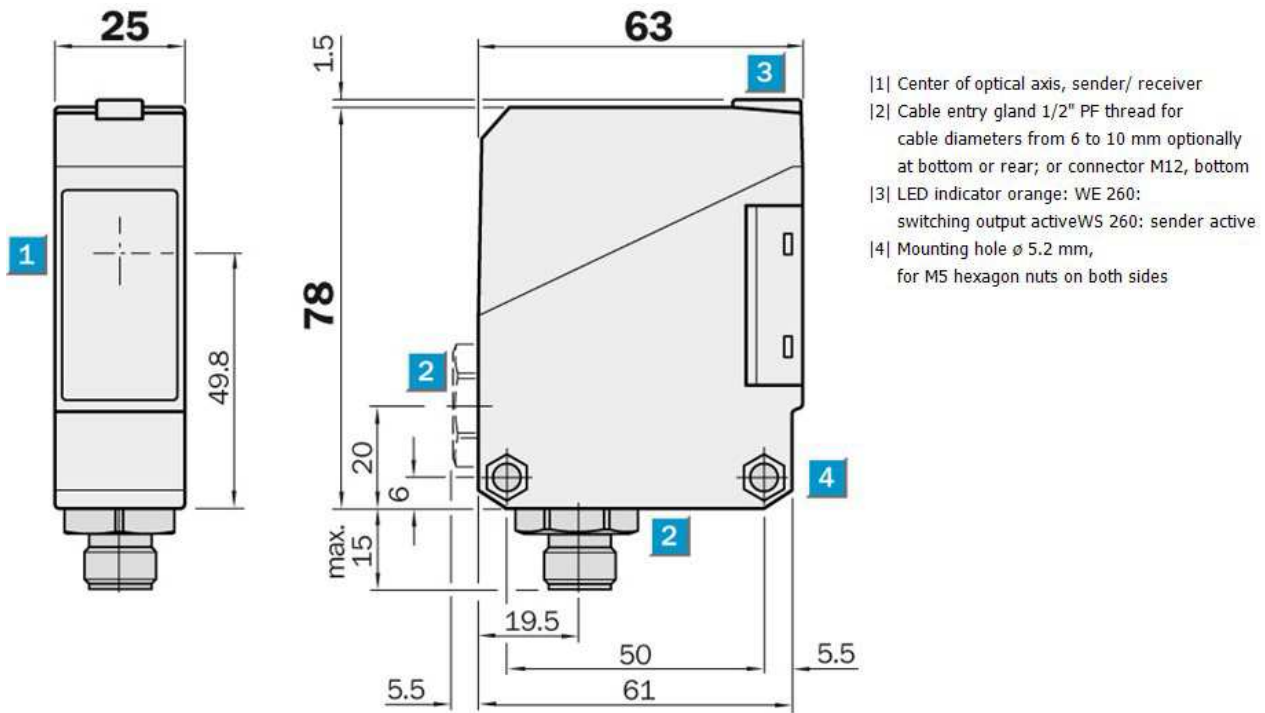

## Adjustments possible

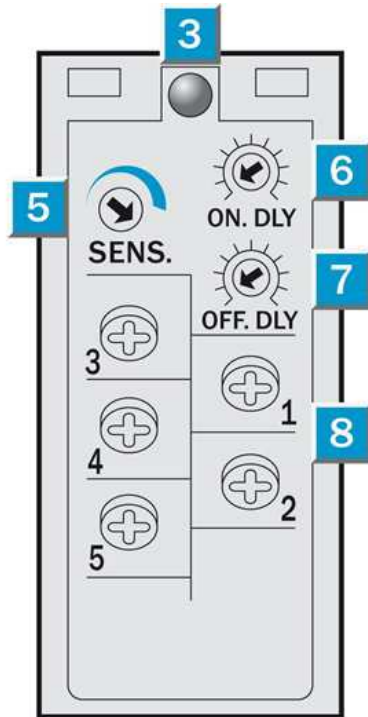

- |3| LED indicator orange: WE 260:  
switching output activeWS 260: sender active
- |5| Sensitivity adjustment
- |6| Time control ON delay tON
- |7| Time control OFF delay tOFF
- |8| Terminals

## Connection diagram

①

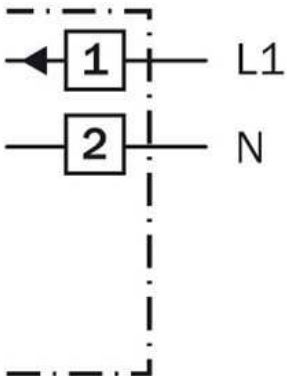

②

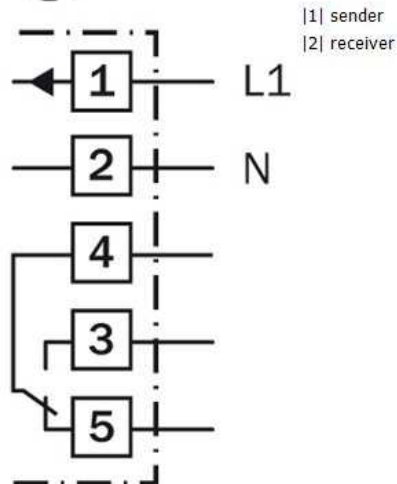

### Characteristic curve

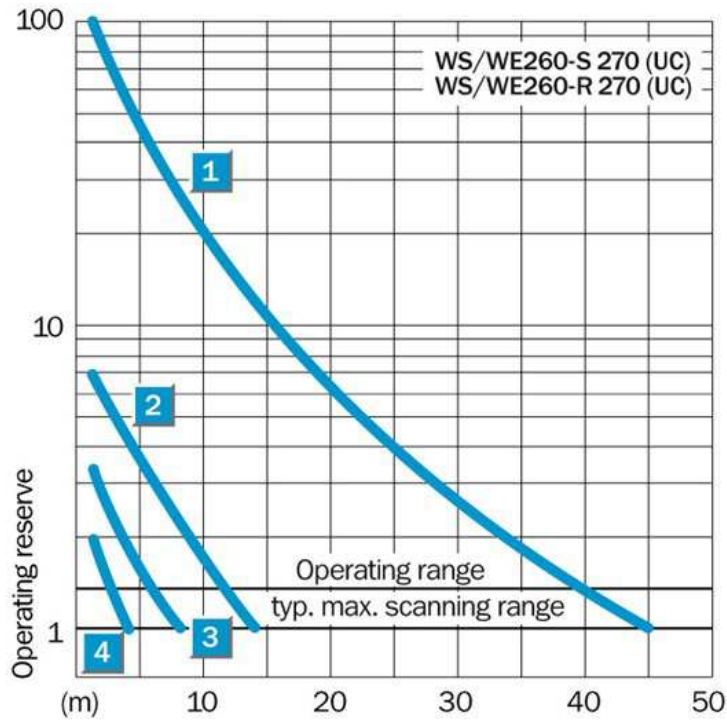

### Sensing range diagram

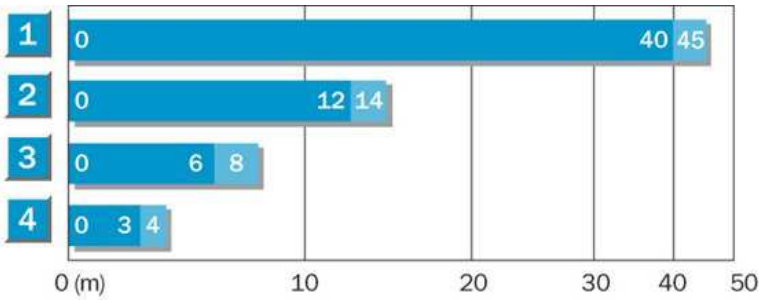

■ Operating range      ■ Typ. max. scanning range

#### Scanning range reduction when using slotted masks

1	Without slotted mask
2	Slot width 5 mm
3	Slot width 2 mm
4	Slot width 1 mm

**Connection type**

---

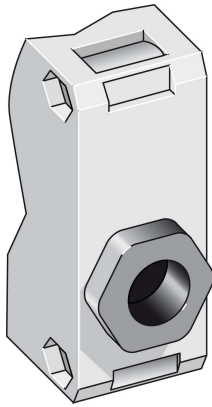

**Australia**

Phone +61 3 9457 0600  
1800 33 48 02 – tollfree  
E-Mail sales@sick.com.au

**Belgium/Luxembourg**

Phone +32 (0)2 466 55 66  
E-Mail info@sick.be

**Brasil**

Phone +55 11 3215-4900  
E-Mail marketing@sick.com.br

**Canada**

Phone +1 905 771 14 44  
E-Mail information@sick.com

**Česká republika**

Phone +420 2 57 91 18 50  
E-Mail sick@sick.cz

**China**

Phone +86 4000 121 000  
E-Mail info.china@sick.net.cn  
Phone +852-2153 6300  
E-Mail ghk@sick.com.hk

**Danmark**

Phone +45 45 82 64 00  
E-Mail sick@sick.dk

**Deutschland**

Phone +49 211 5301-301  
E-Mail info@sick.de

**España**

Phone +34 93 480 31 00  
E-Mail info@sick.es

**France**

Phone +33 1 64 62 35 00  
E-Mail info@sick.fr

**Great Britain**

Phone +44 (0)1727 831121  
E-Mail info@sick.co.uk

**India**

Phone +91-22-4033 8333  
E-Mail info@sick-india.com

**Israel**

Phone +972-4-6881000  
E-Mail info@sick-sensors.com

**Italia**

Phone +39 02 27 43 41  
E-Mail info@sick.it

**Japan**

Phone +81 (0)3 5309 2112  
E-Mail support@sick.jp

**Magyarország**

Phone +36 1 371 2680  
E-Mail office@sick.hu

**Nederland**

Phone +31 (0)30 229 25 44  
E-Mail info@sick.nl

**Norge**

Phone +47 67 81 50 00  
E-Mail sick@sick.no

**Österreich**

Phone +43 (0)22 36 62 28 8-0  
E-Mail office@sick.at

**Polska**

Phone +48 22 837 40 50  
E-Mail info@sick.pl

**România**

Phone +40 356 171 120  
E-Mail office@sick.ro

**Russia**

Phone +7-495-775-05-30  
E-Mail info@sick.ru

**Schweiz**

Phone +41 41 619 29 39  
E-Mail contact@sick.ch

**Singapore**

Phone +65 6744 3732  
E-Mail sales.gsg@sick.com

**Slovenija**

Phone +386 (0)1-47 69 990  
E-Mail office@sick.si

**South Africa**

Phone +27 11 472 3733  
E-Mail info@sickautomation.co.za

**South Korea**

Phone +82 2 786 6321/4  
E-Mail info@sickkorea.net

**Suomi**

Phone +358-9-25 15 800  
E-Mail sick@sick.fi

**Sverige**

Phone +46 10 110 10 00  
E-Mail info@sick.se

**Taiwan**

Phone +886 2 2375-6288  
E-Mail sales@sick.com.tw

**Türkiye**

Phone +90 (216) 528 50 00  
E-Mail info@sick.com.tr

**United Arab Emirates**

Phone +971 (0) 4 88 65 878  
E-Mail info@sick.ae

**USA/México**

Phone +1(952) 941-6780  
1 (800) 325-7425 – tollfree  
E-Mail info@sickusa.com

More representatives and agencies  
at [www.sick.com](http://www.sick.com)