

Hand-held pressure indicator

Model CPH6200-S1 (1-channel version)

Model CPH6200-S2 (2-channel version)

WIKA data sheet CT 11.01



for further approvals
see page 4

Applications

- Calibration service companies and service industry
- Measurement and control laboratories
- Quality assurance

Special features

- Digital indicator with interchangeable pressure sensors (plug-and-play)
- Measuring ranges from 0 ... 25 mbar to 0 ... 1,000 bar (0 ... 0.4 psi to 0 ... 14,500 psi)
- Type of pressure: Positive and negative overpressure, absolute pressure and differential pressure
- Accuracy: 0.2 %, optionally 0.1 % (incl. calibration certificate)
- Software and complete service cases (incl. pumps) available



Model CPH6200-S1 hand-held pressure indicator with optional model CPT6200 reference pressure sensor

Description

Extensive application possibilities

Stainless steel pressure sensors with measuring ranges up to 1,000 bar (14,500 psi) are available for the model CPH6200 hand-held pressure indicator. Therefore, it is particularly suitable as a test instrument for applications such as process technology, machine building, etc. The digital indicator automatically detects the measuring range of the connected pressure sensor and guarantees a highly accurate pressure measurement.

Functionality

The CPH6200 can be used for measuring both gauge and absolute pressure. Differential pressure measurement is possible with the 2-channel version CPH6200-S2, and two connected model CPT6200 reference pressure sensors. Selectable pressure units here are bar, mbar, psi, Pa, kPa, MPa, mmHg or inHg.

An integrated data logger and various other functions such as Min., Max., Hold, Tare, zero point adjustment, alarm, power-off, peak value detection (1,000 measurements/s), average value filter, etc. ensure that the CPH6200 can be used for many different applications.

Software

In addition to the GSoft data logger evaluation software for the tabular and graphical representation of the logged data, WIKI-Cal calibration software for calibration tasks is also available. WIKI-Cal also offers, over and above PC-supported calibration, the management of the calibration and instrument data in an SQL database. A USB interface is available for the data transfer.

Complete test and service cases

For maintenance and service applications, various case systems are available. These include service cases with or without pressure generation, rechargeable battery, battery charger, connection adapter, etc.

Certified accuracy

For each reference pressure sensor, the accuracy for the complete measuring chain is certified by a factory calibration certificate which accompanies the instrument. On request, we can provide a DKD/DAkkS calibration certificate for this instrument.

Specifications

| Model CPH6200 hand-held pressure indicator (complete measuring chain) | | | | | | | |
|---|---|---------------|---------------|--|---------------|--------------|---------|
| Measuring inputs | 1 input for CPH6200-S1 2 inputs for CPH6200-S2 | | | | | | |
| Measuring range | | | | | | | |
| Gauge pressure | mbar | -600 ... 0 | -600 ... +600 | -400 ... 0 | -400 ... +400 | -250 ... 0 | |
| | | -250 ... +250 | -100 ... +100 | -20 ... +60 | -20 ... +40 | -20 ... +25 | |
| | | 0 ... 25 | 0 ... 40 | 0 ... 60 | 0 ... 100 | 0 ... 160 | |
| | | 0 ... 250 | 0 ... 400 | 0 ... 600 | | | |
| | bar | -1 ... 0 | -1 ... 1.5 | -1 ... 3 | -1 ... 5 | -1 ... 9 | |
| | | -1 ... 15 | -1 ... 24 | -1 ... 39 | 0 ... 1 | 0 ... 1.6 | |
| | | 0 ... 2.5 | 0 ... 4 | 0 ... 6 | 0 ... 10 | 0 ... 16 | |
| | | 0 ... 25 | 0 ... 40 | 0 ... 60 | 0 ... 70 | 0 ... 100 | |
| | | 0 ... 160 | 0 ... 250 | 0 ... 400 | 0 ... 600 | 0 ... 1,000 | |
| | | 0 ... 2,320 | 0 ... 3,630 | 0 ... 5,800 | 0 ... 8,700 | 0 ... 14,500 | |
| | psi | -9 ... 0 | -9 ... +9 | -4...0 | -4 ... +4 | -1,5...+1,5 | |
| | | -1,5 ... 0 | 0 ... 0,4 | 0 ... 0,6 | 0 ... 0,9 | 0 ... 1,5 | |
| | | 0 ... 2,5 | 0 ... 4 | 0 ... 6 | 0 ... 10 | 0 ... 14,5 | |
| | | 0 ... 25 | 0 ... 40 | 0 ... 60 | 0 ... 90 | 0 ... 145 | |
| | | 0 ... 250 | 0 ... 360 | 0 ... 580 | 0 ... 870 | 0 ... 1,450 | |
| | | 0 ... 2,320 | 0 ... 3,630 | 0 ... 5,800 | 0 ... 8,700 | 0 ... 14,500 | |
| | Absolute pressure | mbar abs. | 0 ... 250 | 0 ... 400 | 0 ... 600 | | |
| | | bar abs. | 0 ... 1 | 0 ... 1.6 | 0 ... 2.5 | 0 ... 4 | 0 ... 6 |
| 0 ... 10 | | | 0 ... 16 | 0 ... 25 | 0.8 ... 1.2 | | |
| psi abs. | | 0 ... 4 | 0 ... 9 | 0... 14,5 | 0 ... 25 | 0 ... 60 | |
| | 0 ... 90 | 0 ... 145 | 0 ... 250 | | | | |
| Overpressure limit | 3 times; ≤ 25 bar 2 times; > 25 bar ... ≤ 600 bar 1.5 times; > 600 bar | | | 3 times; ≤ 360 psi 2 times; > 360 psi ... ≤ 8,700 psi 1.5 times; > 8,700 psi | | | |
| Resolution | dependent on pressure range (max. 4 1/2-digit) | | | | | | |
| Accuracy of the measuring chain ¹⁾ | 0.2 % FS (resolution 4-digit); {optional: 0.1 % FS (resolution: 4 1/2-digit)} ²⁾ | | | | | | |
| Types of pressure | Gauge pressure, {absolute pressure from 0 ... 25 bar abs. (0 ... 360 psi abs.) and vacuum from -1 ... +39 bar (-14.5 ... 550 psi)} Differential pressure measurement only with CPH6200-S2, and two model CPT6200 reference pressure sensors connected. | | | | | | |
| Sensor compatibility | Compatible with model CPT6200 reference pressure sensors | | | | | | |

{ } Items in curved brackets are optional extras for an additional price.

1) It is defined by the total measurement uncertainty, which is expressed with the coverage factor ($k = 2$) and includes the following factors: the intrinsic performance of the instrument, the measurement uncertainty of the reference instrument, long-term stability, influence of ambient conditions, drift and temperature effects over the compensated range during a periodic zero point adjustment.

2) Reference conditions: 15 ... 25 °C (59 ... 77 °F)

Digital indicator model CPH6200**Indication**

| | |
|------------------|---|
| Display | Large 4 1/2-digit LC display for indication of two pressure values and additional information |
| Indication range | -19999 ... 19999 digits, depending on sensor used |
| Pressure units | bar, mbar, psi, Pa, kPa, MPa, mmHg and inHg (depending on the measuring range, freely selectable) |

Functions

| | |
|----------------------------|---|
| Measuring rate | 4/s ("slow"); 1,000/s ("fast"); > 1,000/s unfiltered (peak value detection), selectable |
| Memory | Min./Max., integrated data logger |
| Functions via button press | Min./Max. memory, Hold, Tare, zero point adjustment, logger (start/stop) |
| Menu functions | Min./Max. alarm (acoustic/visual), sea level (barometric air pressure), power-off function, measuring rate, mean value filter |
| Mean value filter | 1 ... 120 seconds, adjustable |
| Data logger | Individual value logger: Up to 99 recordings incl. time via button press Cyclic logger: Automatic recording of up to 10,000 values incl. time Cycle time: Selectable from 1 ... 3,600 seconds |
| Real-time clock | integrated clock with date |

Voltage supply

| | |
|--------------|--|
| Power supply | 9 V battery, alternatively: 9 V rechargeable battery or mains supply |
| Battery life | > 300 hours of operation (1 sensor with a measuring rate of 4/s) |

Permissible ambient conditions

| | |
|-----------------------|-----------------------------------|
| Operating temperature | 0 ... 50 °C (32 ... +122 °F) |
| Storage temperature | -20 ... +70 °C (-4 ... +158 °F) |
| Relative Humidity | 0 ... 95 % r. h. (non-condensing) |

Communication

| | |
|-----------------|---|
| Interface | USB via interface cable |
| Analogue output | DC 0 ... 1 V; configurable (selectable via menu alternative to interface) |

Case

| | |
|-----------------------|--|
| Material | impact-resistant ABS plastic, membrane keyboard, transparent screen |
| Ingress protection | IP65, IP67 (both ingress protection types are met) |
| Electrical connection | Sensor cable: Bayonet connector, 7-pin Interface: Stereo plug, 3.5 mm |
| Dimensions | See technical drawing |
| Weight | approx. 160 g (0.35 lbs) (incl. battery) |

Reference pressure sensor model CPT6200

| | |
|---|---|
| Process connection ⁴⁾ | G ½ B; {flush (G 1 for 0.1 ... 1.6 bar (1.5 ... 23.2 psi)) or various connection adapters on request} |
|---|---|

Material

| | |
|------------------------------|--|
| Wetted parts | Stainless steel or Elgiloy®, (> 25 bar (360 psi) additionally with NBR seal) ³⁾ Flush diaphragm version: Stainless steel {Hastelloy C4}; O-ring: NBR {FKM/FPM or EPDM} |
| Internal transmission medium | Synthetic oil (only for measuring ranges to 16 bar (250 psi) or flush diaphragm) {Halocarbon oil for oxygen applications}; {Listed by FDA for food industry} |

Sensor data

| | |
|------------------------------|---|
| Accuracy ¹⁾ | ≤ 0.2 % of span at reference conditions ²⁾ |
| Compensated range | 0 ... 80 °C (0 ... 176 °F) |
| Mean temperature coefficient | ≤ 0.2 % of span/10 K (outside the reference conditions) |

{ } Items in curved brackets are optional extras for an additional price.

1) It is defined by the total measurement uncertainty, which is expressed with the coverage factor ($k = 2$) and includes the following factors: the intrinsic performance of the instrument, the measurement uncertainty of the reference instrument, long-term stability, influence of ambient conditions, drift and temperature effects over the compensated range during a periodic zero point adjustment.

2) Reference conditions: 15 ... 25 °C (59 ... 77 °F)

3) For pressure measuring ranges 0 ... 25 mbar, 0 ... 40 mbar and 0 ... 60 mbar (0 ... 0.4 psi, 0 ... 0.6 psi and 0 ... 0.9 psi) all wetted parts are made of stainless steel, silicon, aluminium, gold, silicone.

4) As an oxygen version, a flush diaphragm model is not available. In an oxygen version, the model CPT6200 is only available in overpressure ranges ≥ 0.25 bar (≥ 0.4 psi), with media temperatures between -10 ... +50 °C (14 ... 122 °F) and using stainless steel or Elgiloy® wetted parts.

Reference pressure sensor model CPT6200

Permissible ambient conditions

| | |
|----------------------------------|---|
| Medium temperature ⁴⁾ | -30 ... +100 °C (-22 ... +212 °F) ⁵⁾ |
| Operating temperature | -20 ... +80 °C (-4 ... +176 °F) |
| Storage temperature | -40 ... +100 °C (-40 ... +212 °F) ⁵⁾ |
| Humidity | 0 ... 95 % r. h. (non-condensing) |









Case

| | |
|---------------------------|--|
| Material | Stainless steel |
| Connection to the CPH6200 | via 1 m (3.3 ft) connection cable (plug-and-play); optional: up to 5 m (16.4 ft) |
| Ingress protection | IP67 |
| Dimensions | See technical drawing |
| Weight | approx. 220 g (0.49 lbs) |

4) As an oxygen version, a flush diaphragm model is not available. In an oxygen version, the model CPT6200 is only available in overpressure ranges ≥ 0.25 bar (≥ 0.4 psi), with media temperatures between -10 ... +50 °C (14 ... 122 °F) and using stainless steel or Elgiloy[®] wetted parts.

5) For pressure measuring ranges 0 ... 25 mbar, 0 ... 40 mbar and 0 ... 60 mbar (0 ... 0.4 psi, 0 ... 0.6 psi and 0 ... 0.9 psi) the medium temperature and storage temperature are limited to +80 °C (176 °F).

Approvals

| Logo | Description | Country |
|--|---|-----------------------------|
|  | EU declaration of conformity for CPH6200 <ul style="list-style-type: none"> ■ EMC directive EN 61326 emission (group 1, class B) and interference immunity (portable equipment) ■ RoHS directive | European Union |
|  | EU declaration of conformity for CPT6200 <ul style="list-style-type: none"> ■ EMC directive EN 61326 emission (group 1, class B) and interference immunity (portable equipment) ■ Pressure equipment directive Module A, internal control of production ■ RoHS directive | European Union |
|  | EAC <ul style="list-style-type: none"> ■ EMC directive ■ Pressure equipment directive ■ Low voltage directive | Eurasian Economic Community |
|  | GOST Metrology, measurement technology | Russia |
|  | KazInMetr Metrology, measurement technology | Kazakhstan |
| - | MTSCHS Permission for commissioning | Kazakhstan |
|  | BelGIM Metrology, measurement technology | Belarus |
|  | UkrSEPRO Metrology, measurement technology | Ukraine |
|  | Uzstandard Metrology, measurement technology | Uzbekistan |
| - | CPA Metrology, measurement technology | China |

Certificates

| Certificate | |
|---|---|
| Calibration | Standard: 3.1 calibration certificate per DIN EN 10204 Option: DKD/DakkS calibration certificate |
| Recommended recalibration interval | 1 year (dependent on conditions of use) |

Approvals and certificates, see website

Dimensions in mm (in)

Digital indicator CPH6200-S1

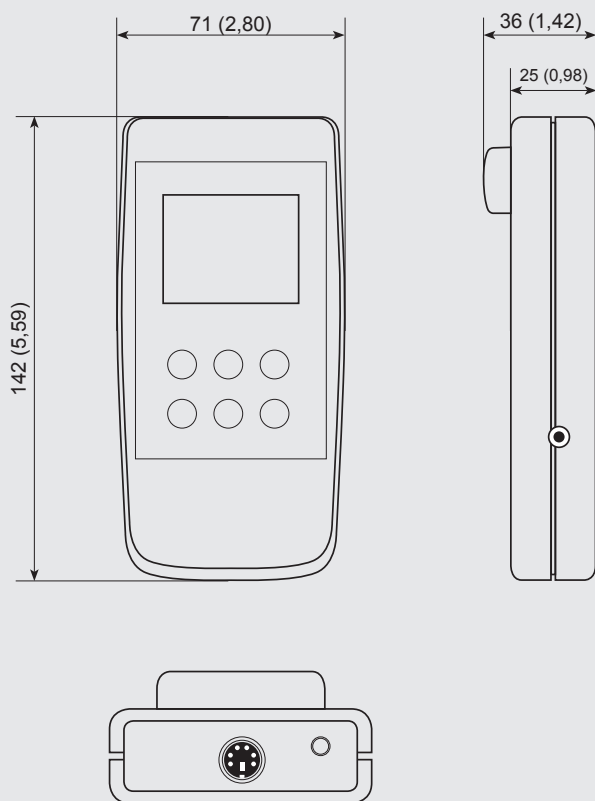

Digital indicator CPH6200-S2

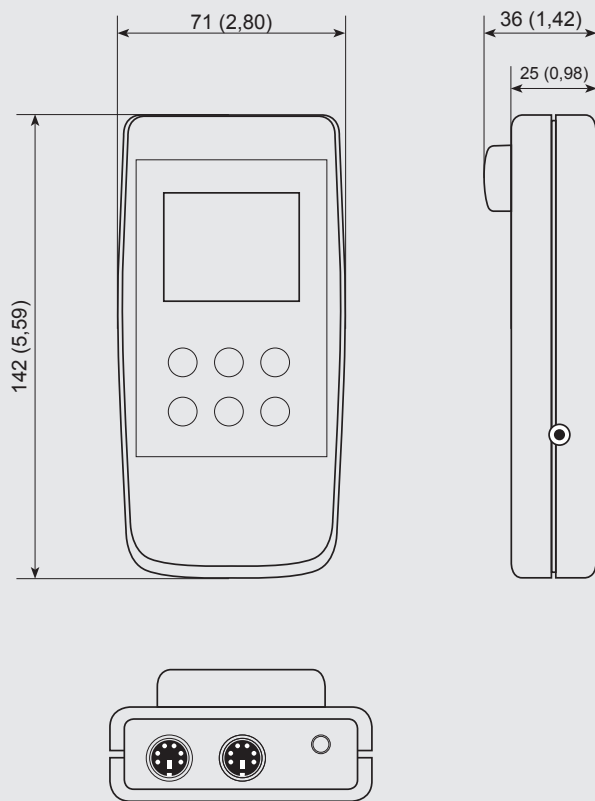

Reference pressure sensor CPT6200

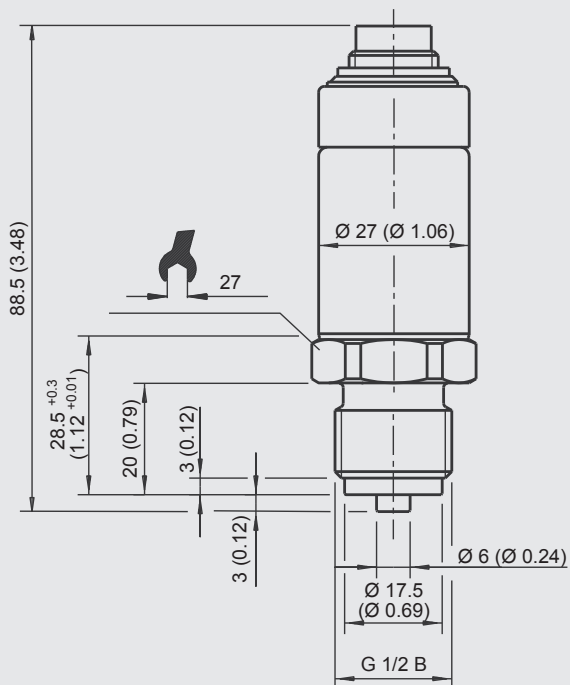

Electrical connections

Model CPH6200-S1

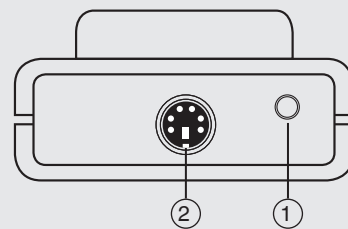

Model CPH6200-S2

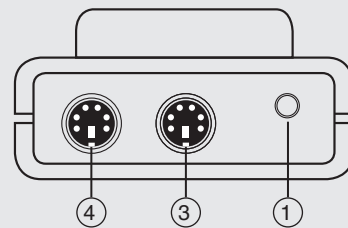

- ① Interface connector
- ② Connection channel 1 (only with CPH6200-S1)
- ③ Connection channel 2 (only with CPH6200-S2)
- ④ Connection channel 1 (only with CPH6200-S2)

Operating functions of the models CPH6200-S1 and CPH6200-S2

1- and 2-channel version with external pressure sensors

Display

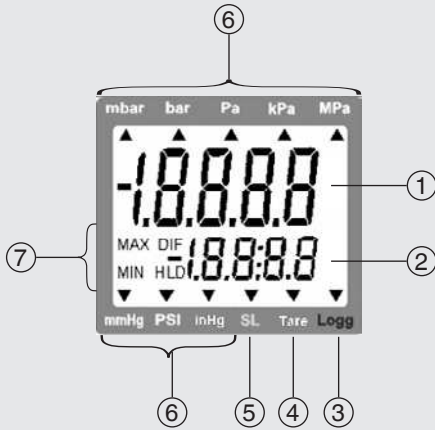

- ① **Main display:** Current measured value for sensor 1
- ② **Secondary display:** Current measured value for sensor 2 or differential value between sensor 1 and sensor 2
- ③ **Logg arrow:** Logger is ready
Arrow blinking: Automatic recording (Logg CYCL) active
- ④ **Tare arrow:** Tare function was activated
- ⑤ **SL arrow:** Height correction (sea level) was activated
- ⑥ Display arrows for **measured value units**
- ⑦ Indication elements for Min./Max. measured value illustration

Keyboard

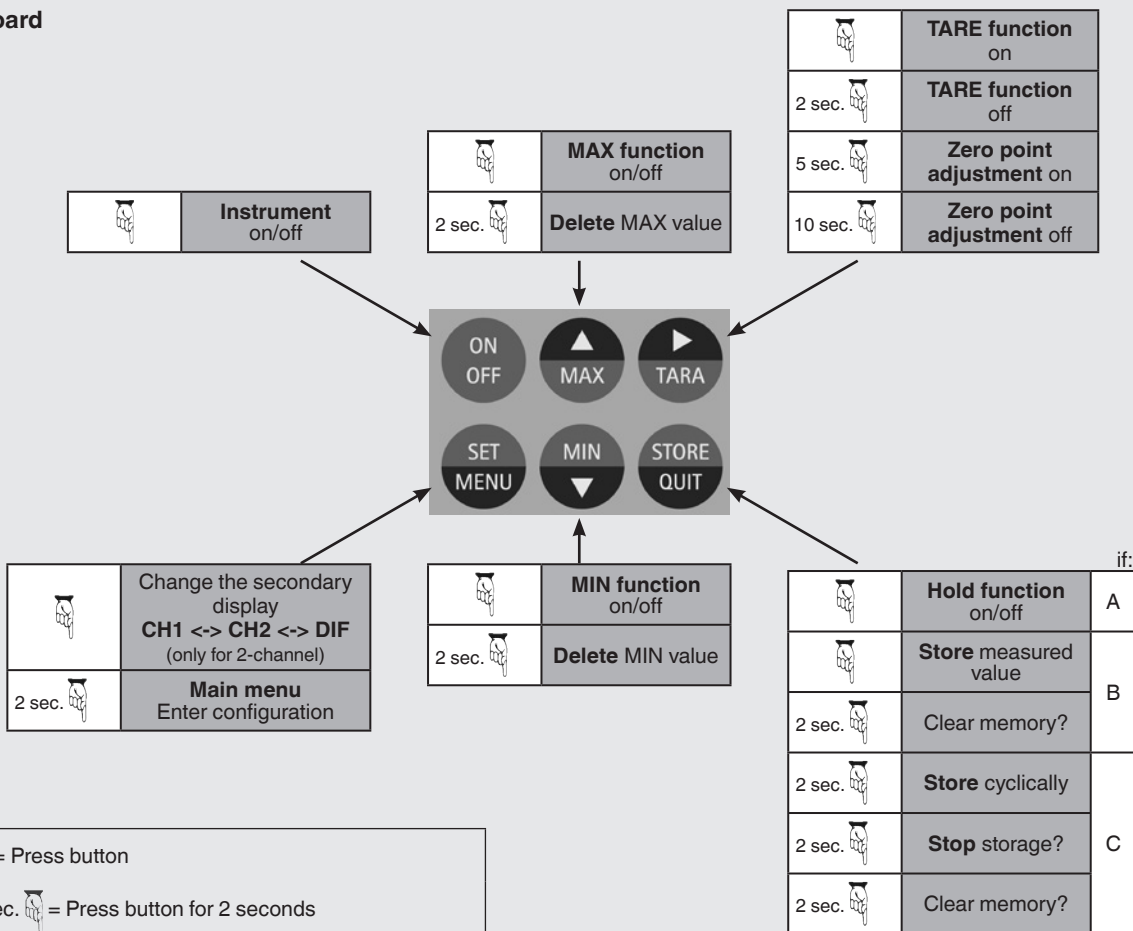

= Press button
 2 sec. = Press button for 2 seconds
 For more information: See operating instructions

A = Logger functions deactivated
 B = Logger function "Store measured value" activated via menu
 C = Logger function "Store cyclically" activated via menu

Complete test and service cases



Basic version

Calibration case with model CPH6200 hand-held pressure indicator for pressure, consisting of:

- Plastic service case with foam insert
- Hand-held pressure indicator model CPH6200
- 9 V battery
- Sealing set
- Sensor cable
- Spaces for several CPT6200 reference pressure sensors

Available measuring ranges see specifications

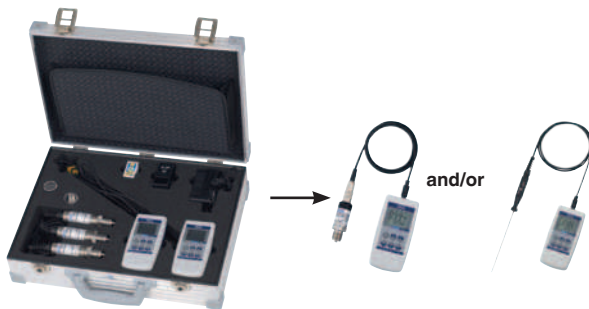

Equipment freely selectable

Calibration case for pressure and/or temperature (equipment freely selectable), consisting of:

- Transport case with foam insert and space for max. 2 hand-held pressure indicators/thermometers, several CPT6200 reference pressure sensors, 2 temperature probes, 1 power supply unit, charger and rechargeable battery or battery

For further specifications see data sheet CT 51.01

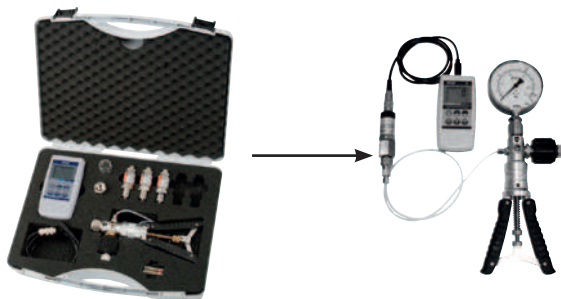

Basic version incl. pneumatic pressure generation

Calibration case with model CPH6200 hand-held pressure indicator and model CPP30 hand test pump for pressures of -0.95 ... 35 bar (-28 inHg ... 500 psi), consisting of:

- Plastic service case with foam insert
- Hand-held pressure indicator model CPH6200
- Pneumatic hand test pump model CPP30; -0.95 ... 35 bar (-28 inHg ... 500 psi)
- Sealing set
- Sensor cable
- Rechargeable battery and charger
- Spaces for several CPT6200 reference pressure sensors

Available measuring ranges see specifications

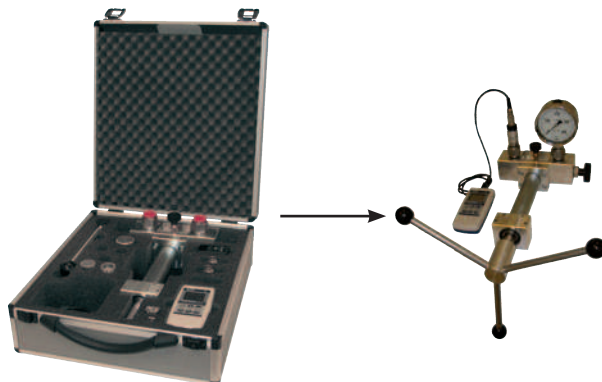

Basic version incl. hydraulic pressure generation

Calibration case with model CPH6200 hand-held pressure indicator and model CPP1000-L hand spindle pump for pressures of 0 ... 1,000 bar (0 ... 14,500 psi), consisting of:

- Transport case with foam insert
- Hand-held pressure indicator model CPH6200
- Hydraulic hand spindle pump model CPP1000-L; 0 ... 1,000 bar (0 ... 14,500 psi)
- Sealing set
- Sensor cable
- Rechargeable battery and charger
- Spaces for several CPT6200 reference pressure sensors

Available measuring ranges see specifications

GSoft data logger evaluation software

The GSoft data logger evaluation software is used to display the logger data of the model CPH6200 hand-held pressure indicator on a PC in tabular form and as chart.

- Easy operation with self-explanatory toolbars
- Data from the pressure and temperature hand-helds (CTH6200) can be displayed in a single chart (two separate y-axes)
- Chart offers a zoom function
- Operation of the logger function via PC (remote control)
- Data can be exported (Excel®, etc.)
- Languages: German, English, French, Spanish and Czech

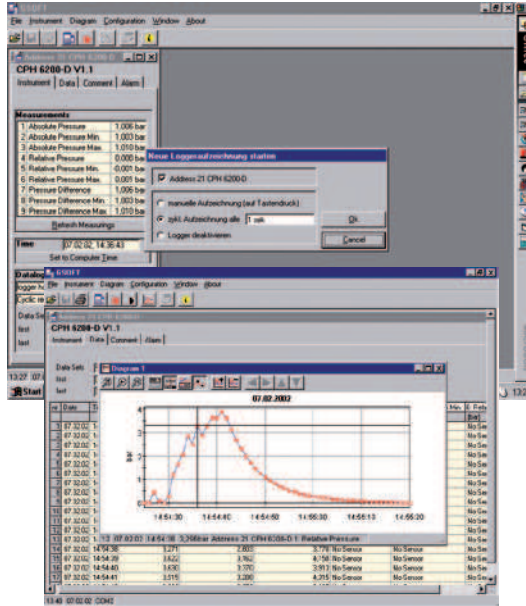

Data export e.g. in an Excel® file

System requirements

- IBM compatible PC (Pentium®)
- At least 20 MB free hard disc space
- CD-ROM drive
- At least 32 MB RAM
- Windows® operating system 95, 98, NT 4.0 (with Service Pack 3.0 or higher), 2000, XP, Vista or 7
- Mouse
- USB port (via interface cable)

To operate the GSoft software with the CPH6200, GSoft version 3.0 or later is needed. Free updates are available for download at www.wika.com.

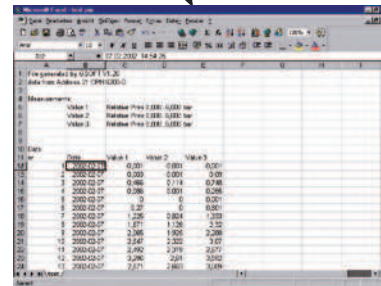

Windows® is a registered trademark of Microsoft Corporation in the United States and other countries.

Easy operation with self-explanatory icon buttons

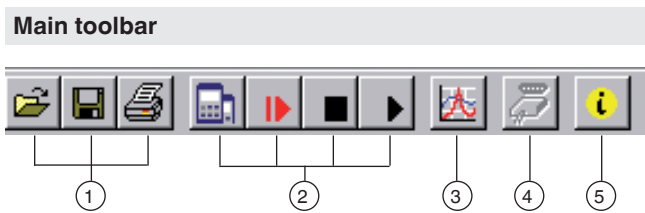

- ① File functions: Open, save, print
- ② Logger functions: Start communication, start logger, stop, read data
- ③ Data display: Create chart
- ④ Interface configuration
- ⑤ Program information
- ⑥ Settings: Grid and colour settings, manual zooms

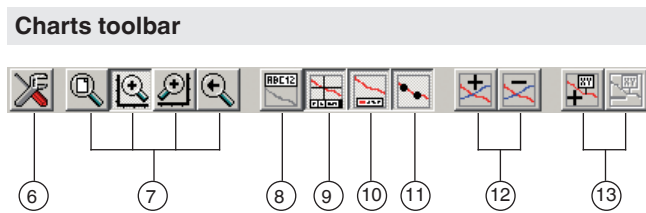

- ⑦ Zoom: All, left or right y-axis (via mouse), back
- ⑧ Rename chart
- ⑨ Cursor on/off (info footer)
- ⑩ Legend on/off
- ⑪ (Measuring point) Symbols on/off
- ⑫ Measurement series (add/delete)
- ⑬ Comments on measuring points (add/delete)

WIKA-Cal calibration software

Easy and fast creation of a high-quality calibration certificate

The WIKA-Cal calibration software is used for generating calibration certificates or logger protocols for pressure measuring instruments and is available as a demo version for a cost-free download.

A template helps the user and guides him through the creation process of a document.

In order to switch from the demo version to a full version of the respective template, a USB stick with the template must be purchased.

The pre-installed demo version automatically changes to the selected full version when the USB stick is inserted and remains available so long as the USB stick is connected to the computer.



- Creation of calibration certificates for mechanical and electronic pressure measuring instruments
- A calibration assistant guides you through the calibration
- Automatic generation of the calibration steps
- Generation of 3.1 certificates per DIN EN 10204
- Creation of logger protocols
- User-friendly interface
- Languages: German, English, Italian and more due with software updates

For further information see data sheet CT 95.10

Calibration certificates can be created with the Cal-Template and logger protocols can be created with the Log-Template.



Cal Demo

Generation of calibration certificates limited to 2 measuring points, with automatic initiation of pressures via a pressure controller.



Cal Light

Generation of calibration certificates with no limitations on measuring points, without automatic initiation of pressures via a pressure controller.



Log Demo

Creation of data logger test reports, limited to 5 measured values.



Log

Creation of data logger test reports without limiting the measured values.

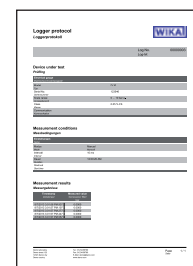
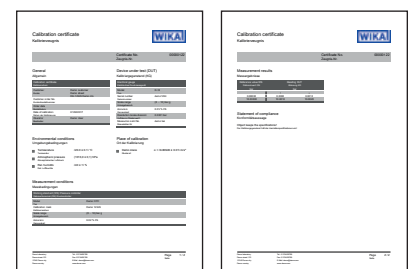

| Accessories | Order code |
|---|-----------------------|
| 9 V rechargeable battery | CPH-A-62-AZZZZZZZZZ-Z |
| 9 V battery | CPH-A-62-BZZZZZZZZZ-Z |
| Charger for 9 V rechargeable battery and 2 rechargeable AAA batteries (Euro standard) | CPH-A-62-1ZZZZZZZZZ-Z |
| Charger for 9 V rechargeable battery and 2 rechargeable AAA batteries (UK standard) | CPH-A-62-2ZZZZZZZZZ-Z |
| Charger for 9 V rechargeable battery and 2 rechargeable AAA batteries (US standard) | CPH-A-62-3ZZZZZZZZZ-Z |
| Power supply unit (Euro standard) | CPH-A-62-4ZZZZZZZZZ-Z |
| Power supply unit (UK standard) | CPH-A-62-5ZZZZZZZZZ-Z |
| Power supply unit (US standard) | CPH-A-62-6ZZZZZZZZZ-Z |
| Sealing set, consisting of 4 x G ½ USIT seals, 2 x G ¼ USIT seals and plastic box | CPH-A-62-DZZZZZZZZZ-Z |
| Sensor connection cable, approx. 1.1 m (3.3 ft) | CPH-A-62-SZZZZZZZZZ-Z |
| Extension cable for connection of sensors, approx. 3.8 m (12.5 ft) to approx. 5 m (16.4 ft) | CPH-A-62-VZZZZZZZZZ-Z |
| 2 connection cable, 2 m (6.6 ft) with loose ends (sleeves) for connecting the configurable analogue output | CPH-A-62-EZZZZZZZZZ-Z |
| Plastic case for 1 x hand-held, 3 x pressure sensors, accessories | CPH-A-62-KZZZZZZZZZ-Z |
| Plastic case for 1 x hand-held, 5 x pressure sensors, 1 x pneumatic hand test pump CPP7-H or CPP30, accessories | CPH-A-62-LZZZZZZZZZ-Z |
| Plastic case for 1 x hand-held, 4 x pressure sensors, 1 x hydraulic hand test pump CPP700-H/ CPP1000-H, accessories | CPH-A-62-NZZZZZZZZZ-Z |
| Transport case made of aluminium for 1 x hand-held, 5 x pressure sensors, 1 x hydraulic hand spindle pump CPP1000-L, accessories | CPH-A-62-MZZZZZZZZZ-Z |
| Transport case made of aluminium (pressure + temperature) for 2 x hand-helds, 5 x pressure sensors, 2 x temperature probes, accessories | CPH-A-62-OZZZZZZZZZ-Z |
| RS-232 interface cable | CPH-A-62-RZZZZZZZZZ-Z |
| USB interface cable | CPH-A-62-UZZZZZZZZZ-Z |
| GSoft data logger evaluation software | CPH-A-62-GZZZZZZZZZ-Z |
| WIKA-Cal calibration software | WIKA-CAL-ZZ-L-Z |

Scope of delivery

- Hand-held pressure indicator model CPH6200-S1, incl. 9 V battery
- One sensor connection cable per channel
- 3.1 calibration certificate per DIN EN 10204
- Choice of sensors

Options

- Hand-held pressure indicator model CPH6200-S2: 2-channel version (differential pressure measurement possible via 2 connected model CPT6200 reference pressure sensors)
- DKD/DAkkS calibration certificate
- Sensors for oxygen applications



Model CPH6200-S2 hand-held pressure indicator with two optional model CPT6200 reference pressure sensors

Ordering information

CPH6200 / Instrument version / Additional cable for reference pressure sensor / Power supply unit / Rechargeable battery and battery charger / Software / Interface cable / Test pump / Transport case / Further approvals / Additional ordering information

CPT6200 / Unit / Measuring range / Accuracy / Process connection / Special design features / Type of certificate / Further approvals / Additional ordering information

© 02/2003 WIKA Alexander Wiegand SE & Co. KG, all rights reserved.
The specifications given in this document represent the state of engineering at the time of publishing.
We reserve the right to make modifications to the specifications and materials.

