

ProcessCalibrator Model CPH6000

WIKA data sheet CT 15.01



for further approvals
see page 4

Applications

- Calibration service companies and service industry
- Maintenance facilities
- Measurement and control laboratories
- Quality assurance

Special features

- Digital indicator with easily interchangeable reference pressure sensors (sensor can also be attached externally)
- Measuring ranges from -1 ... 6,000 bar (-14.5 ... 87,000 psi)
- Accuracy: 0.025 % (incl. calibration certificate)
- Calibration and pressure-switch test functions
- Software and complete service cases (incl. pumps) available



ProcessCalibrator model CPH6000

Description

Handling

For a solution that always matches the application, there are many pressure sensors to choose from, with accuracies of up to 0.025 % and measuring ranges up to 6,000 bar (87,000 psi), which can be interchanged quickly and without tools. In addition to being fixed to the instrument, the reference pressure sensor can, optionally, be used externally via an approx. 1.2 m (4 ft) long connecting cable. If the reference pressure sensor on the instrument is changed, then the digital indicator will recognise the new measuring range and so this saves the operator from having to configure it via the menu.

Functionality

In the setup menu there are 3 operating modes to choose from:

MEASURING, CALIBRATION and PRESSURE SWITCH-TEST. In the CALIBRATION and PRESSURE SWITCH-TEST modes, a menu assistant supports the user during

each operation and records, for example, the calibration data from several calibrations or automatically calculates the switch hysteresis. To power the test item and to read its measurement signals, there are electrical inputs and outputs which are protected from adverse conditions in the field by captive protection caps.

Software

For the evaluation and documentation of the calibration data stored in the CPH6000, WIKA-Cal calibration software is available. Using this software, the data is automatically transferred into a printable calibration certificate. Furthermore, WIKA-Cal also offers, over and above PC-supported calibration, the management of the calibration and instrument data in an SQL database. For data transfer, an RS-232 and a USB interface are available.

Complete test and service cases

For maintenance and service applications, various service case systems are available. These include service cases with or without pressure generation, charger, test-cable set, adapter, etc.

Certified accuracy

For each reference pressure sensor, the accuracy is certified by a factory calibration certificate which accompanies the instrument. On request, we can provide a DKD/DAkkS calibration certificate for this instrument.

Specifications

ProcessCalibrator model CPH6000						
Sensor technology	1 reference pressure sensor (interchangeable without tools) 1); Option: external operation via 1.2 m (4 ft) cable					
Measuring range						
Gauge	bar	-0.25 ... +0.25	-0.4 ... +0.4	-0.6 ... +0.6	-1 ... 0	-1 ... 1.5
		-1 ... 2.5	-1 ... 3	-1 ... 5	-1 ... 9	-1 ... 15
		-1 ... 24	-1 ... 39	0 ... 0.25	0 ... 0.4	0 ... 0.6
		0 ... 1	0 ... 1.6	0 ... 2.5	0 ... 4	0 ... 6
		0 ... 10	0 ... 16	0 ... 25	0 ... 40	0 ... 60
		0 ... 100	0 ... 160	0 ... 250	0 ... 400	0 ... 600
		0 ... 1,000				
	psi	-4 ... +4	-6 ... +6	-10 ... +10	-14.5 ... 0	-14.5 ... 22
		-14.5 ... 36	-14.5 ... 44	-14.5 ... 73	-14.5 ... 130	-14.5 ... 220
		-14.5 ... 350	-14.5 ... 565	0 ... 4	0 ... 6	0 ... 10
		0 ... 14,5	0 ... 25	0 ... 40	0 ... 60	0 ... 90
		0 ... 145	0 ... 250	0 ... 360	0 ... 580	0 ... 870
		0 ... 1,450	0 ... 2,320	0 ... 3,630	0 ... 5,800	0 ... 8,700
		0 ... 14,500				
Accuracy of the measuring chain	0.025 % FS 2)					
Gauge	bar	0 ... 1,600	0 ... 2,500	0 ... 4,000	0 ... 5,000	0 ... 6,000
	psi	0 ... 23,200	0 ... 36,200	0 ... 58,000	0 ... 72,500	0 ... 87,000
Accuracy of the measuring chain	0.1 % FS 2)					
Absolute pressure	bar abs.	-0.8 ... 1.2	0 ... 0.25	0 ... 0.4	0 ... 0.6	0 ... 1
		0 ... 1.6	0 ... 2.5	0 ... 4	0 ... 6	0 ... 10
		0 ... 16	0 ... 25			
	psi abs.	-11.6 ... 17.4	0 ... 4	0 ... 6	0 ... 8	0 ... 14.5
		0 ... 23	0 ... 36	0 ... 60	0 ... 90	0 ... 145
		0 ... 230	0 ... 360			
Accuracy of the measuring chain	0.025 % FS 2)					
Overpressure limit (dependent on the measuring range)	3 times; < 25 bar 2 times; > 25 bar ... ≤ 600 bar 1,5 times; > 600 bar ... ≤ 2,500 bar 1,2 times; > 2,500 bar			3 times; < 360 psi 2 times; > 360 psi ... ≤ 8,700 psi 1,5 times; > 8,700 psi ... ≤ 36,260 psi 1,2 times; > 36,260 psi		
Types of pressure	Relative pressure, {absolute pressure from 0 ... 25 bar abs. (0 ... 360 psi abs.) and vacuum from -1 ... 39 bar (-14.5 ... 550 psi)}					
Sensor compatibility	Compatible with model CPT6000 reference pressure sensors					

{ } Items in curved brackets are optional extras for an additional price.

1) Up to 10 reference pressure sensors can be supported on each instrument (up to 10 calibration data sets).

2) Calibrated at 23 °C (74 °F) and in vertical mounting position, pressure connection facing downwards.

Digital indicator model CPH6000**Display**

Display	Large TFT colour screen for the display of reference and test signals and additional information
Display resolution	up to 6 digits; adjustable
Pressure units	mbar, bar, psi, Pa, hPa, kPa, MPa, mmHg, cmHg, inHg, mmH ₂ O, cmH ₂ O, mH ₂ O, inH ₂ O, kg/cm ² and a customer-specific unit (freely selectable dependant on measuring range)

Functions

Operating mode	MEASURING, CALIBRATION and SWITCH-TEST
Functions	MEASURING, CALIBRATION and SWITCH-TEST Min/Max memory, Tare, Min/Max alarm (audible/visual), filter (running average), zero-point adjustment, PowerSave function
Measuring rate	2 values/s
Menu languages	English, German, Spanish, French, Italian, Russian (settable)

CALIBRATE function

Memory capacity	up to 16 test items
Test points/test item	up to 32 comparison points

SWITCH-TEST function

Switch points	Determination of the switch point and automatic calculation of the hysteresis
---------------	---

Measuring input, voltage ³⁾

Measuring range	DC 0 ... 1 V; DC 0 ... 2 V; DC 0 ... 5 V; DC 0 ... 10 V
Resolution	up to 6 digits; adjustable
Accuracy	1.0 mV

Measuring input, current ³⁾

Measuring range	0 ... 20 mA; 4 ... 20 mA
Resolution	up to 6 digits; adjustable
Accuracy	5.0 µA

Output

Voltage supply	DC 24 V [load: max. 50 mA; min 20 mA] (can be activated via menu)
----------------	---

Power supply

Supply	Internal Lithium-Ion rechargeable battery (charging time: < 6 h)
Battery life	approx. 20 hours of operation

Permissible ambient conditions

Operating temperature	0 ... 50 °C (32 ... 122 °F) ⁴⁾
Storage temperature	-20 ... +70 °C (-4 ... +158 °F)
Relative humidity	0 ... 85 % r. h. (non-condensing)

Communication

Interface	RS-232 and USB
-----------	----------------

Case

Material	impact-resistant ABS plastic, membrane keypad, transparent screen
Ingress protection	IP54 (with protection caps closed)
Dimensions	see technical drawing
Weight	approx. 850 g (1.87 lbs.)

³⁾ Factory calibration certificate (optional: DKD/DAkkS calibration certificate).







⁴⁾ The power supply is only intended for a temperature of 0 ... 45 °C (32 ... 113 °F) approved

Reference pressure sensor model CPT6000	
Pressure connection	≤ 1,000 bar (≤ 14,500 psi): G ½ B; {various connection adapters on request} > 1,000 bar (> 14,500 psi): M16 x 1.5 female, with sealing cone
Material	
Wetted parts	Stainless steel (with measuring ranges > 25 bar ... ≤ 1,000 bar (> 360 ... ≤ 14.500 psi) Elgiloy® in addition)
Internal transmission fluid	Synthetic oil (only for measuring ranges up to 25 bar (360 psi)) {Halocarbon oil for oxygen variants} 5)
Sensor specifications	
Accuracy per year	≤ 0.025 % FS (only with CPH6000)
Compensated range	0 ... 50 °C (32 ... 122 °F)
Permissible ambient conditions	
Medium temperature	-20 ... +80 °C (-4 ... +176 °F) 5)
Operating temperature	-20 ... +80 °C (-4 ... +176 °F)
Storage temperature	-40 ... +85 °C (-40 ... +185 °F) 5)
Relative humidity	0 ... 95 % r. h. (non-condensing)
Case	
Material	Stainless steel
Connection to the CPH6000	Option: external operation via 1.2 m (4 ft) connection cable (plug-and-play)
Ingress protection	IP65 (with cable connected)
Dimensions	see technical drawing
Weight	approx. 230 g (0.5 lbs.)

{ } Items in curved brackets are optional extras for an additional price.

5) For oxygen versions, the medium temperature must not exceed 60 °C (140 °F).

Approvals

Logo	Description	Country
	EU declaration of conformity for CPH6000 <ul style="list-style-type: none"> ■ EMC directive ■ EN 61326 emission (group 1, class B) and interference immunity (portable measuring equipment) ■ RoHS directive 	European Union
	EU declaration of conformity for CPT6000 <ul style="list-style-type: none"> ■ EMC directive ■ EN 61326 emission (group 1, class B) and interference immunity (industrial application) ■ Pressure equipment directive ■ PS > 200 bar, module A, pressure accessory ■ RoHS directive 	European Union
	EAC <ul style="list-style-type: none"> ■ EMC directive ■ Pressure equipment directive ■ Low voltage directive 	Eurasian Economic Community
	GOST Metrology/measurement technology	Russia
-	MTSCHS Commissioning approval	Kazakhstan
	BelGIM Metrology/measurement technology	Belarus
	UkrSEPRO Metrology/measurement technology	Ukraine
	Uzstandard Metrology/measurement technology	Uzbekistan
-	CPA Metrology/measurement technology	China

Certificates

Certificate	
Calibration	Standard: 3.1 calibration certificate per DIN EN 10204 Option: DKD/DAkkS calibration certificate
Recommended recalibration interval	1 year (dependent on conditions of use)

Approvals and certificates, see website

Dimensions in mm (in)

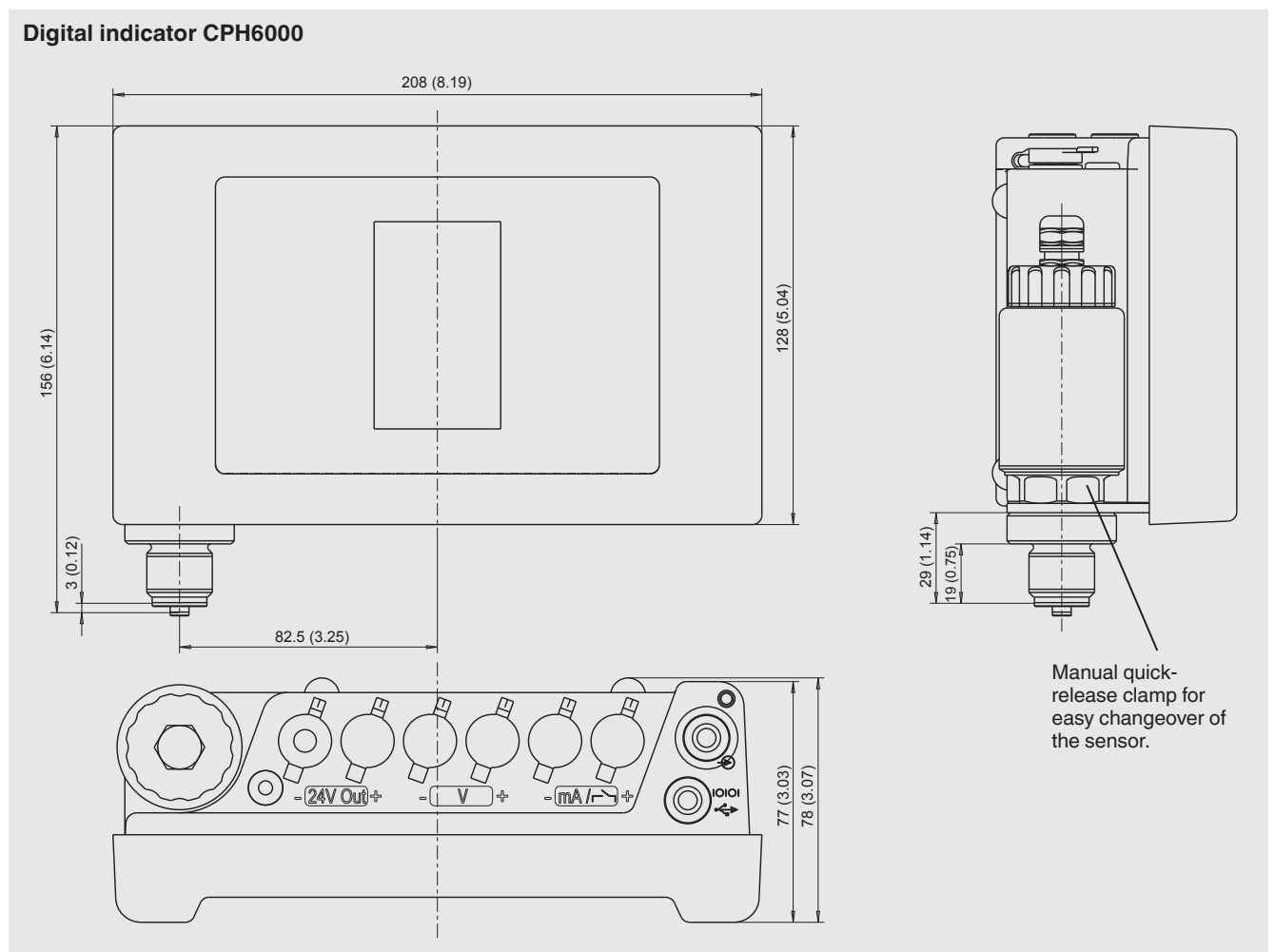

Dimensions in mm (in)

Reference pressure sensor CPT6000

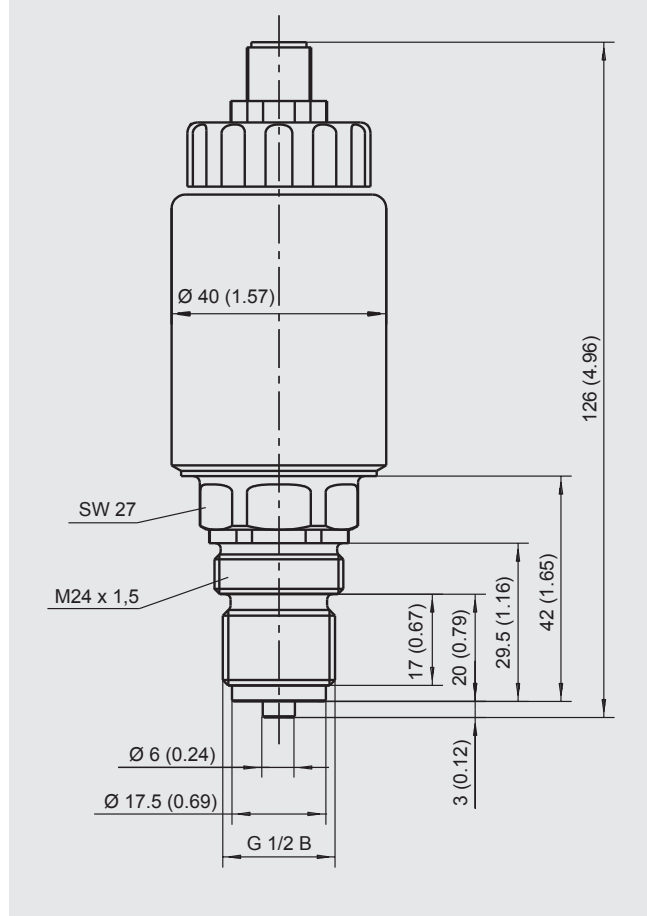

Electrical connections to the digital indicator

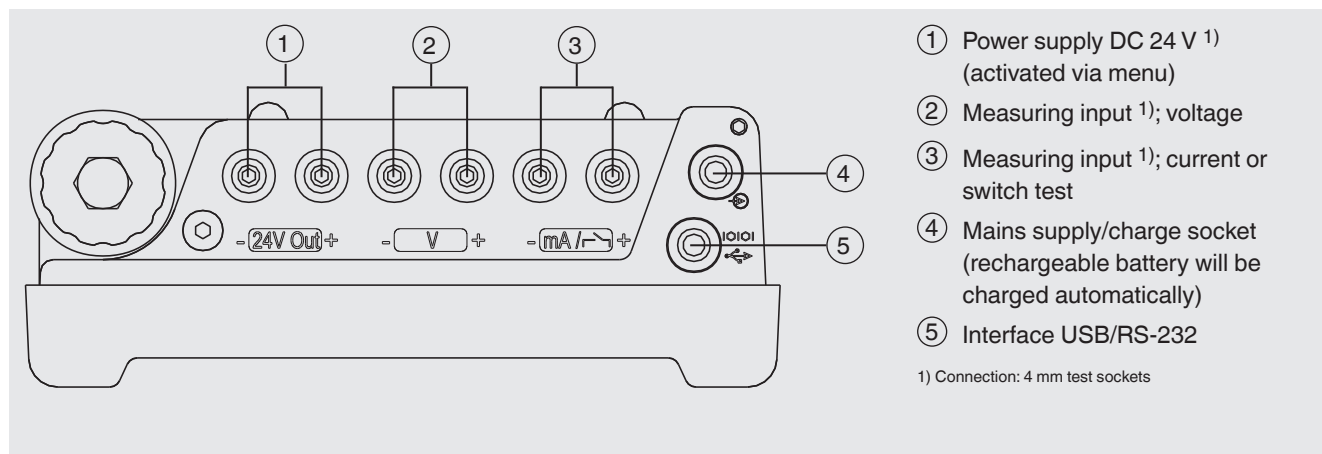

Electrical connection for: CALIBRATION

2-wire test item

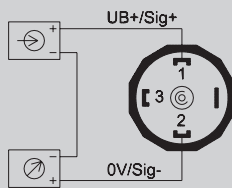

Example:
mA signal test item without its own power supply (24 V must be activated via menu)

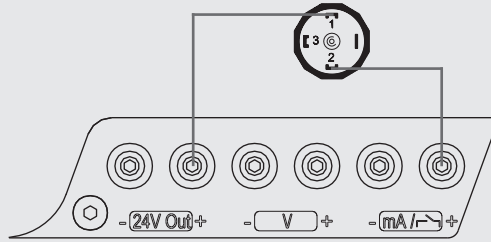

Example:
mA signal test item with its own power supply available

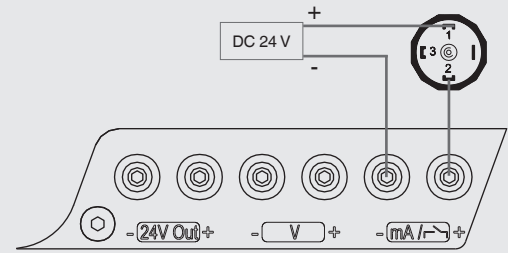

3-wire test item

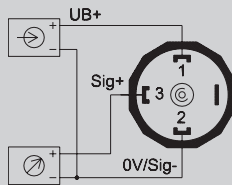

Example:
mA signal test item without its own power supply (24 V must be activated via menu)

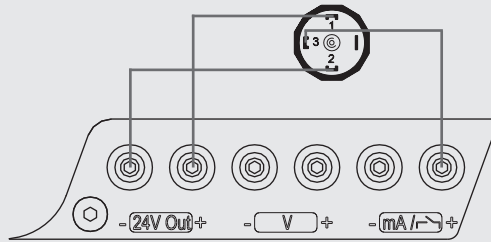

Example:
V signal test item with its own power supply available

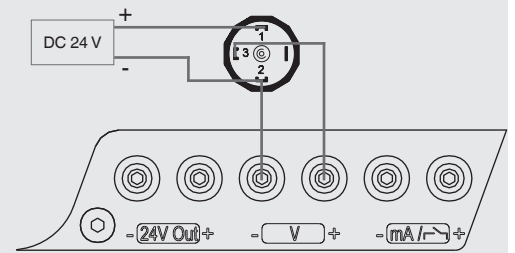

Electrical connection for: SWITCH-TEST

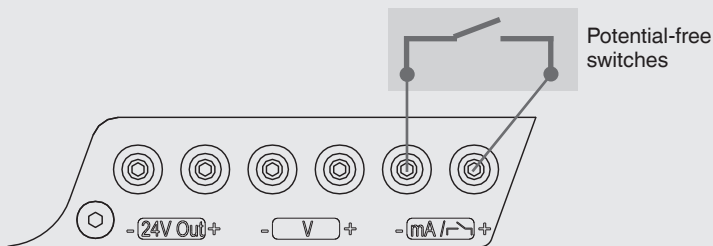

Types of switch:

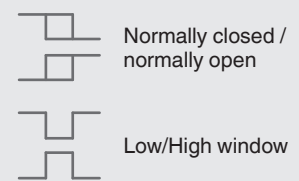

User interface

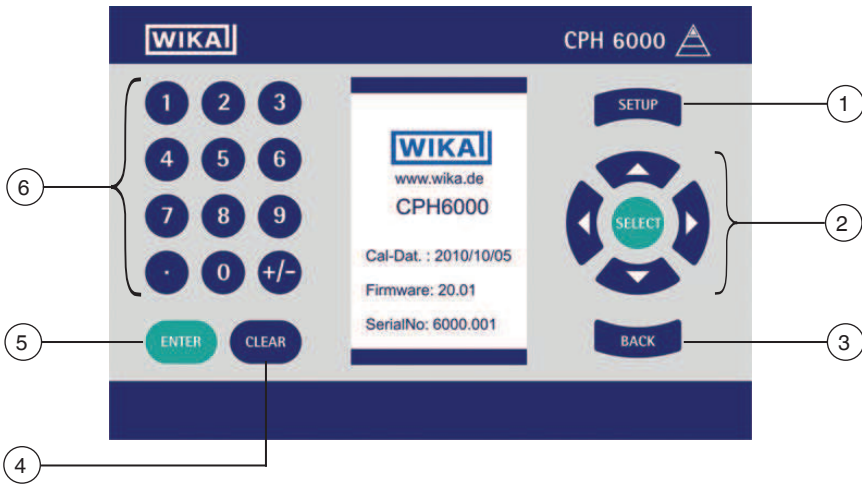

- ① Setup menu
- ② Selection and entry confirmation
- ③ One step back
- ④ Clear entry
- ⑤ Entry acknowledgment
- ⑥ Numeric keypad

Switch on via pressing any button.
Switch off via menu item in main menu.

Menu structure

Operating modes

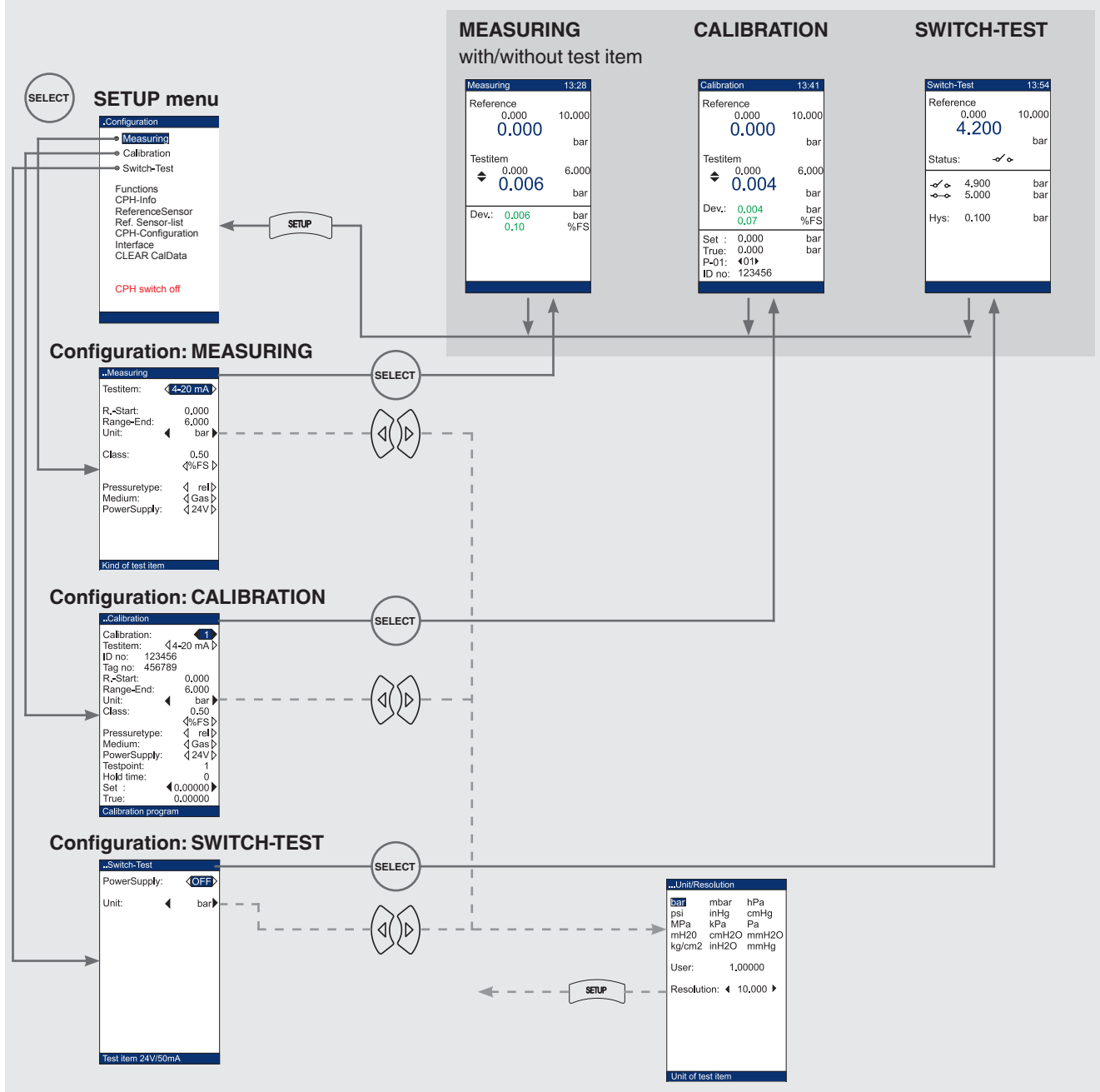

Operating modes: MEASURING, CALIBRATION and SWITCH-TEST

Operating mode: MEASURING



A) with fixed reference pressure sensor



B) with external reference pressure sensor

Measuring		13:28
Reference	0,000	10,000
	0.000	bar
Testitem	0,000	6,000
	0.006	bar
Dev.:	0,006	bar
	0,10	%FS

with/without display of test item

Features

- Up to 6 display digits
- 15 pressure units + 1 programmable unit
- Programmable functions: Min./Max./Tare/Filter/Alarm/Altitude correction
- The display of the test item measured value is also possible as an original electrical signal (mA/V)

Applications

- Measurement of operating/process pressures
- Comparative measurements with test items (power supply and display for the test item through the CPH6000)
- Min. and Max. memory (e.g. for leak testing)
- Alarm function for safety testing

Operating mode: CALIBRATION

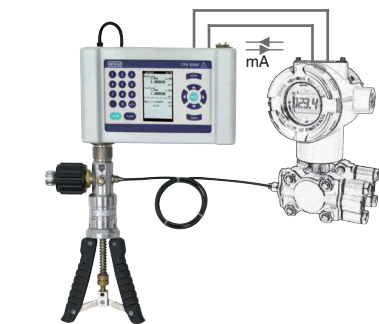

A) Record calibration data

Calibration		13:41
Reference	0,000	10,000
	0.000	bar
Testitem	0,000	6,000
	0.004	bar
Dev.:	0,004	bar
	0,07	%FS
Set :	0,000	bar
True:	0,000	bar
P-01:	001	
ID no:	123456	

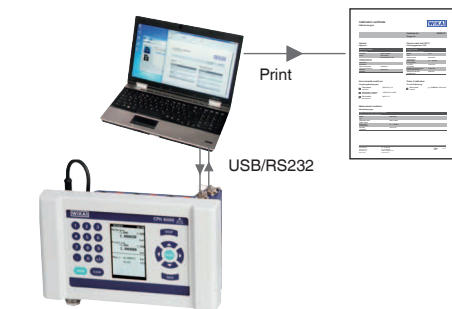

B) Record calibration data on a PC and print the calibration certificate

Features

- Calibration assistant
- Programmable altitude correction
- Recordable calibration temperature

Applications

- On-site calibration of pressure sensor and pressure measuring instruments (without PC)
- A calibration assistant guides you easily through the calibration (following DKD/DAkKS). With this, the data sets, including date and time, are recorded within the CPH6000. Prior to calibration, the calibration steps can be entered directly on the instrument or downloaded via WIKA-Cal software.

PC software available

- WIKA-Cal calibration software for creating calibration certificates

Operating mode: SWITCH-TEST

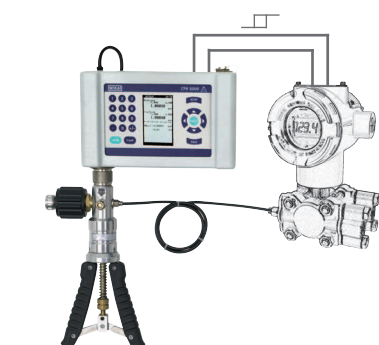

With switch-test assistant

Switch-Test		13:54
Reference	0,000	10,000
	4.200	bar
Status:		↕
↕	4,900	bar
↔	5,000	bar
Hys:	0,100	bar

Features

- Switch-test assistant
- Automatic calculation of the hysteresis

Applications

- Convenient checking of pressure switches
- A pressure switch-test assistant conveniently guides the operator through the checking and automatic calculation of the switch hysteresis.

Complete test and service cases

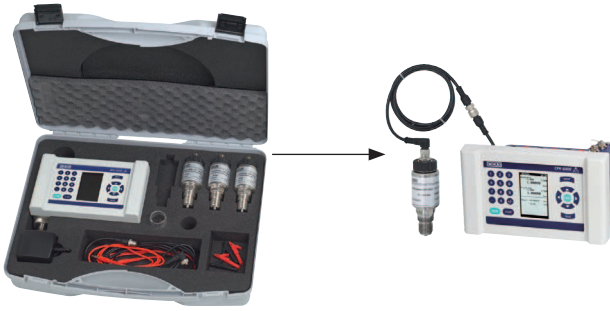

Basic version

Calibration case with model CPH6000 ProcessCalibrator for pressures consisting of:

- Plastic service case with foam insert
- ProcessCalibrator model CPH6000
- Sensor cable for external operation of sensor
- Test-cable set with connection terminals
- Charger
- Interface cable
- Sealing set
- Spaces for several CPT6000 reference pressure sensors

Available measuring ranges see specifications.



Basic version incl. pneumatic pressure generation

Calibration case with model CPH6000 ProcessCalibrator and model CPP30 hand test pump for pressures -0.95 ... +35 bar (-28 inHg ... 500 psi) consisting of:

- Transport case with model CPH6000 ProcessCalibrator
- Model CPP30 pneumatic hand test pump; -0.95 ... +35 bar (-28 inHg ... 500 psi)
- Sensor cable for external operation of sensor
- Test-cable set with connection terminals
- Charger
- Interface cable
- Sealing set
- Spaces for several CPT6000 reference pressure sensors

Available measuring ranges see specifications.



Basic version incl. hydraulic pressure generation

Calibration case with model CPH6000 ProcessCalibrator and model CPP1000-L hand spindle pump for pressures up to 1,000 bar (14.500 psi) consisting of:

- Transport case with model CPH6000 ProcessCalibrator
- Model CPP1000-L hydraulic hand spindle pump up to 1,000 bar (14.500 psi)
- Sensor cable for external operation of sensor
- Test-cable set with connection terminals
- Charger
- Interface cable
- Sealing set
- Spaces for several CPT6000 reference pressure sensors

Available measuring ranges see specifications.

WIKA-Cal calibration software

Easy and fast creation of a high-quality calibration certificate

The WIKA-Cal calibration software is used for generating calibration certificates or logger protocols for pressure measuring instruments and is available as a demo version for a cost-free download.

A template helps the user and guides him through the creation process of a document.

In order to switch from the demo version to a full version of the respective template, a USB stick with the template has to be purchased.

The pre-installed demo version automatically changes to the selected full version when the USB stick is inserted and is available as long as the USB stick is connected to the computer.



- Creation of calibration certificates for mechanical and electronic pressure measuring instruments
- A calibration assistant guides you through the calibration
- Automatic generation of the calibration steps
- Generation of 3.1 certificates per DIN EN 10204
- Creation of logger protocols
- User-friendly interface
- Languages: German, English, Italian and more due with software updates

For further information see data sheet CT 95.10

Calibration certificates can be created with the Cal-Template and logger protocols can be created with the Log-Template.



Cal Demo

Generation of calibration certificates limited to 2 measuring points, with automatic initiation of pressures via a pressure controller.



Cal Light

Generation of calibration certificates with no limitations on measuring points, without automatic initiation of pressures via a pressure controller.



Log Demo

Creation of data logger test reports, limited to 5 measured values.



Log

Creation of data logger test reports without limiting the measured values.

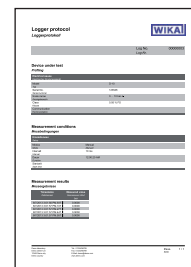
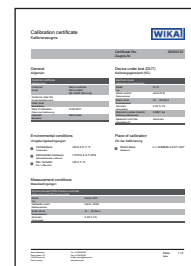

Scope of delivery

- ProcessCalibrator model CPH6000
- Battery charger
- Test-cable set with various connection terminals
- 3.1 calibration certificate per EN 10204
- Choice of sensors

Options

- DKD/DAkkS certified accuracy
- Sensors for oxygen applications

Accessories

Connection adapters

- Various pressure adapters
- MINIMESS® quick-connect process connection system

Power supply

- Battery charger

Connection cables

- Test-cable set with various connection terminals
- USB or RS-232 interface cable

Pressure generation

- Pneumatic test pumps
- Hydraulic test pumps

Test cases

- Various calibration cases incl. pressure generation

Software

- WIKA-Cal calibration software

Ordering information

CPH6000 / Ingress protection / Additional cable for reference pressure sensor / Software / Interface cable / Test pump / Transport case / Additional order information

CPT6000 / Operating pressure range / Unit / Measuring range / Accuracy / Process connection / Special design features / Type of certificate / Additional order information

© 04/2005 WIKA Alexander Wiegand SE & Co. KG, all rights reserved.
The specifications given in this document represent the state of engineering at the time of publishing.
We reserve the right to make modifications to the specifications and materials.



WIKAL Alexander Wiegand SE & Co. KG
Alexander-Wiegand-Straße 30
63911 Klingenberg/Germany
Tel. +49 9372 132-0
Fax +49 9372 132-406
info@wika.de
www.wika.de