

Compact temperature switch Model TCS

WIKA data sheet TV 31.64



Process Compact Series

Applications

- Temperature monitoring and control of processes
- Safety-critical applications in general process instrumentation, especially in the chemical and petrochemical industries, oil and gas industries, power generation incl. nuclear power plants, water/wastewater industries, mining
- For measuring points with limited space, e.g. control panels

Special features

- No power supply needed for switching of electrical loads
- Setting ranges from -30 ... +10 °C to 160 ... 250 °C
- Intrinsic safety Ex ia available
- 1 set point, SPDT or DPDT, high switching power up to AC 250 V, 15 A
- Direct mounting or remote mounting with capillary ≤ 10 m



Fig. left: Remote mounting with capillary
Fig. right: Direct mounting

Description

These high-quality temperature switches have been developed especially for safety-critical applications. The high quality of the products and manufacturing in accordance with ISO 9001 ensure reliable monitoring of your plant. In production, the switches are traced by quality assurance software at every step and subsequently are 100 % tested.

In order to ensure as flexible operation as possible, the temperature switches are fitted with micro switches, which enable the switching of an electrical load of up to AC 250 V, 15 A directly. For lower switching power ratings, such as for PLC applications, micro switches with gold-plated contacts can be selected as an option.

All wetted materials are from stainless steel as a standard. The measuring system parts and the flexible spiral armour are made of stainless steel.

The model TCS temperature switch is extremely robust and guarantees optimal operating characteristics in a limited space with repeatability lower than 1 % of span.

Standard version

Measuring principle

Vapour pressure measuring system (SAMA IIC and IIA)

Switch enclosure

- Aluminium alloy, copper-free, epoxy resin coated
- Stainless steel 316L

Tamper-proof

Laser-engraved product label from stainless steel

Ingress protection

IP66 per EN/IEC 60529, NEMA 4X

Permissible ambient temperature

-40 ... +85 °C

Switch contact

Micro switches with fixed dead band

- 1 x SPDT (single pole double throw)
- 1 x DPDT (double pole double throw)

The DPDT function is realised with 2 simultaneously triggering SPDT micro switches within 2 % of the span

| Contact version | | Electrical rating (resistive load) | | Suitable for Ex ia option |
|-----------------|---|------------------------------------|--|---------------------------|
| | | AC | DC | |
| A | 1 x SPDT, silver | 250 V, 15 A | 24 V, 2 A, 125 V, 0.5 A, 220 V, 0.25 A | No |
| B | 1 x SPDT, silver, hermetically sealed, argon gas filling ²⁾ | 250 V, 15 A | 24 V, 2 A, 220 V, 0.5 A | Yes |
| C | 1 x SPDT, gold-plated, hermetically sealed, argon gas filling ²⁾ | 125 V, 1 A | 24 V, 0.5 A | Yes |
| G | 1 x DPDT, silver | 250 V, 5 A | 24 V, 0.5 A | No |
| H | 1 x DPDT, silver, hermetically sealed, argon gas filling ²⁾ | 250 V, 5 A | 24 V, 0.5 A | Yes |

²⁾ Permissible ambient temperature range: -30 ... +70 °C

Set point adjustment

The set point can be specified by the customer or factory-set within the setting range. Subsequent adjustment of the set point on site is made using the adjustment screw, which is covered by the access cover plate with lead seal option.

Repeatability of the set point

≤ 1 % of span

Please specify:

Set point, switching direction for the contact, e.g.:

Set point: 50 °C, rising

After unscrewing the access cover plate, set point adjustment can be made using the adjustment screw. The set point is selectable within the entire setting range.

For optimal performance we suggest to adjust the set point between 25 ... 75 % of the setting range.

Ignition protection type (option)

- Ex ia I Ma (mines), only available with stainless steel switch enclosure
- Ex ia IIC T6/T4 ¹⁾ Ga (gas)
- Ex ia IIIC T85/T135 ¹⁾ Da (dust)

¹⁾ The temperature class is related to the ambient temperature range. See the type examination certificate for further details.

Safety-related maximum values

(only for Ex ia version)

| Maximum values | |
|----------------------------|---------|
| Voltage U_i | DC 30 V |
| Current I_i | 100 mA |
| Power P_i | 0.75 W |
| Internal capacitance C_i | 0 μF |
| Internal inductance L_i | 0 mH |

Example

Setting range: 40 ... 100 °C with one switch contact

Repeatability: 1 % of 60 °C = 0.6 °C

Dead band = 1.5 °C (see table setting range)

2 x repeatability + dead band = 2 x 0.6 °C + 1.5 °C = 2.7 °C

Rising temperature: Adjust set point between 42.7 ... 100 °C.

Falling temperature: Adjust set point between 40 ... 97.3 °C.

Sensor version

- Direct mounting
- Remote mounting with capillary

Sensor dimensions

Direct mounting

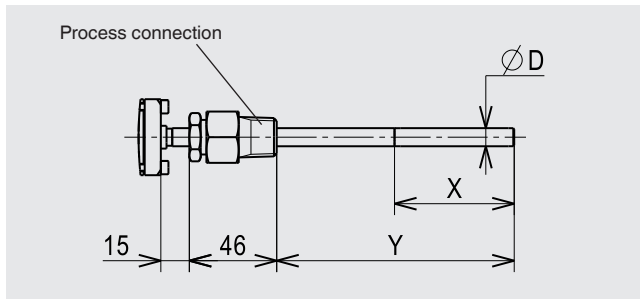

Remote mounting with capillary

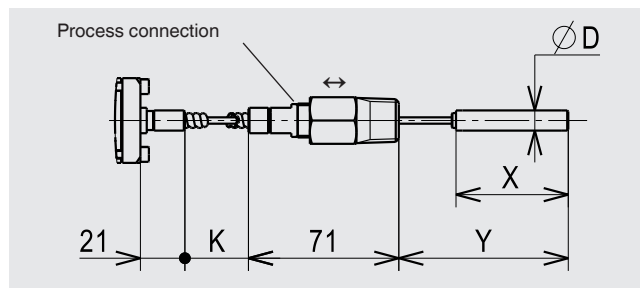

Adjustable insertion length Y for remote mounting with capillary

Due to the flexibility of the spiral armour, the insertion length (Y) can be adjusted during installation with the sliding compression fitting. The insertion length is adjustable between Y_{min} and Y_{max} (see table).

Example

Capillary length K: 2 m
 Setting range: 40 ... 100 °C (SAMA class IIC)
 Stem diameter Ø D: 9.5 mm

Minimum insertion length $Y_{min} = 100$ mm
 Maximum insertion length $Y_{max} = 350$ mm

Adjustable insertion length $Y = 100 \dots 350$ mm
 The capillary length is reduced accordingly.

Maximum capillary reduction
 $K^- = Y_{max} - Y_{min} = 350 - 100 = 250$ mm

Minimum capillary length
 $K_{min} = K - K^- = 2,000 - 250 = 1,750$ mm

Due to the adjustable insertion length (Y) of 100 ... 350 mm, the resulting capillary length (K) varies between 2.0 ... 1.75 m.

Process connection

Stainless steel compression fitting, sliding on capillary or stem

- ½ NPT male (standard)
- ¾ NPT male
- G ½ A male
- G ¾ A male

| SAMA class ¹⁾ | Stem Ø D in mm | Active length X in mm | Insertion length Y in mm |
|--------------------------|----------------|-----------------------|--------------------------|
| IIC | 9.5 | 65 | 125 ²⁾ |
| IIA | 9.5 | 55 | 125 ²⁾ |

1) See table "Setting range" on page 4

2) Other insertion length for direct mounting ≤ 1 m, on request

| SAMA class ¹⁾ | Bulb | | Insertion length in mm | | Capillary length K in m |
|--------------------------|----------------|-----------------------|------------------------|-----------|-------------------------|
| | Stem Ø D in mm | Active length X in mm | Y_{min} | Y_{max} | |
| IIC | 9.5 | 71 | 100 | 350 | 2 |
| | | 84 | 130 | 900 | 5 |
| | | 124 | 170 | 1,800 | 10 |
| IIA ³⁾ | 9.5 | 55 | 100 | 350 | 2 |
| | | 55 | 100 | 900 | 5 |
| | | 55 | 100 | 1,800 | 10 |

1) See table "Setting range" on page 4

3) For SAMA IIA ranges the recommended height difference between sensor and case is ≤ 2 m. Otherwise the "bulb elevation error" has to be considered.

Electrical connection

- ½ NPT female (standard)
- ¾ NPT, M 20 x 1.5, G ½, G ¾ female
- Cable gland non-armoured, nickel-plated brass
- Cable gland non-armoured, stainless steel (AISI 304)
- Cable gland armoured, nickel-plated brass
- Cable gland armoured, stainless steel (AISI 304)

For cable connections to the internal terminal block use wire cross-sections between 0.5 ... 1.5 mm².

For the grounding cable connection to the protective conductor screws use max. 2.5 mm² for the internal screw and max. 4 mm² for the external screw.

Dielectric strength

Safety class I (IEC 61298-2: 2008)

Mounting option

- Direct
- Wall bracket (only for remote mounting with capillary)
 Option: Mounting bracket for 2" pipe mounting

Weight

Depending on switch enclosure: Aluminium alloy / AISI 316L

- 1.2 kg / 1.7 kg, direct mounting
- 1.4 kg / 1.9 kg, remote mounting with 2 m capillary

Setting range

| Setting range | Working range | Proof temperature | Fixed dead band for contact version | | | SAMA class |
|---------------|---------------|-------------------|-------------------------------------|------------------------------|------------------------------|-------------------|
| in °C | in °C | in °C | 1 contact SPDT A, B, C in °C | 1 contact DPDT G in °C | 1 contact DPDT H in °C | |
| -30 ... +10 | -40 ... +60 | 90 | ≤ 2 | ≤ 2 | ≤ 8 | IIC |
| -15 ... +40 | -40 ... +60 | 90 | ≤ 1.5 | ≤ 2 | ≤ 8 | IIC |
| 10 ... 70 | -40 ... +70 | 90 | ≤ 1.5 | ≤ 2 | ≤ 8 | IIC |
| 40 ... 100 | -40 ... +120 | 140 | ≤ 1.5 | ≤ 2 | ≤ 8 | IIC |
| 70 ... 120 | -40 ... +170 | 180 | ≤ 1.5 | ≤ 4 | ≤ 16 | IIA ¹⁾ |
| 90 ... 160 | -40 ... +170 | 180 | ≤ 2 | ≤ 4 | ≤ 16 | IIA |
| 130 ... 190 | -40 ... +190 | 210 | ≤ 2.5 | ≤ 4 | ≤ 16 | IIA |
| 160 ... 250 | -40 ... +280 | 300 | ≤ 2.5 | ≤ 4 | ≤ 16 | IIA |

1) Permissible ambient temperature -40 ... ≤ +70 °C. In case of ambient temperature > 70 ... ≤ 85 °C SAMA class changes to IIC. Dimensions X and Y change accordingly.

Thermowell

In principle, the operation of a mechanical temperature switch without a thermowell is possible with low process-side loading (low pressure, low viscosity and low flow velocities).

However, in order to enable exchanging the temperature switch during operation (e.g. instrument replacement or calibration) and to ensure a better protection of the instrument and also the plant and the environment, it is advisable to use a thermowell from the extensive WIKA thermowell portfolio.

For further information on the calculation of the thermowell, see Technical information IN 00.15.





Options

- Other process connection, also with adapter
- Permissible ambient temperature -60 ... +85 °C ²⁾
- Helical bulb for measuring ranges: -15 ... +40 °C and 10 ... 70 °C
- Contact bulb, to measure surface temperatures on flat surfaces or pipes
- Other insertion length for direct mounting, ≤ 1 m
- Offshore version ³⁾
- NACE version ³⁾

2) Only available for contacts without hermetic sealing

3) WIKA recommends argon gas-filled contact versions, use of adjustable dead band allowed.

Approvals

| Logo | Description | Country |
|--|---|-----------------------------|
|  | EU declaration of conformity <ul style="list-style-type: none"> ■ Low voltage directive ■ ATEX ⁴⁾ directive (option) I M 1 (only available with stainless steel 316L switch enclosure) II 1 GD | European Community |
|  | IECEX ⁴⁾ (option) per IEC 60079-0, IEC 60079-11, IEC 60079-26 Ex ia I Ma (only available with stainless steel 316L switch enclosure) Ex ia IIC T6/T4 ⁵⁾ Ga Ex ia IIIC T85/T135 ⁵⁾ Da | IECEX member states |
|  | EAC (option) Hazardous areas | Eurasian Economic Community |
|  | KOSHA (option) Hazardous areas | South Korea |

4) Double marking ATEX and IECEx on the same product label.

5) The temperature class is related to the ambient temperature range. See the type examination certificate for further details.

Manufacturer's information and certificates

| Logo | Description |
|--|---|
|  | SIL 2 rating (option) , per IEC 61508 Functional safety The electrical rating for DC applications is limited to 30 V / 100 mA. |

Certificates (option)

- 2.2 test report per EN 10204
- 3.1 inspection certificate per EN 10204

Approvals and certificates, see website

Dimensions in mm

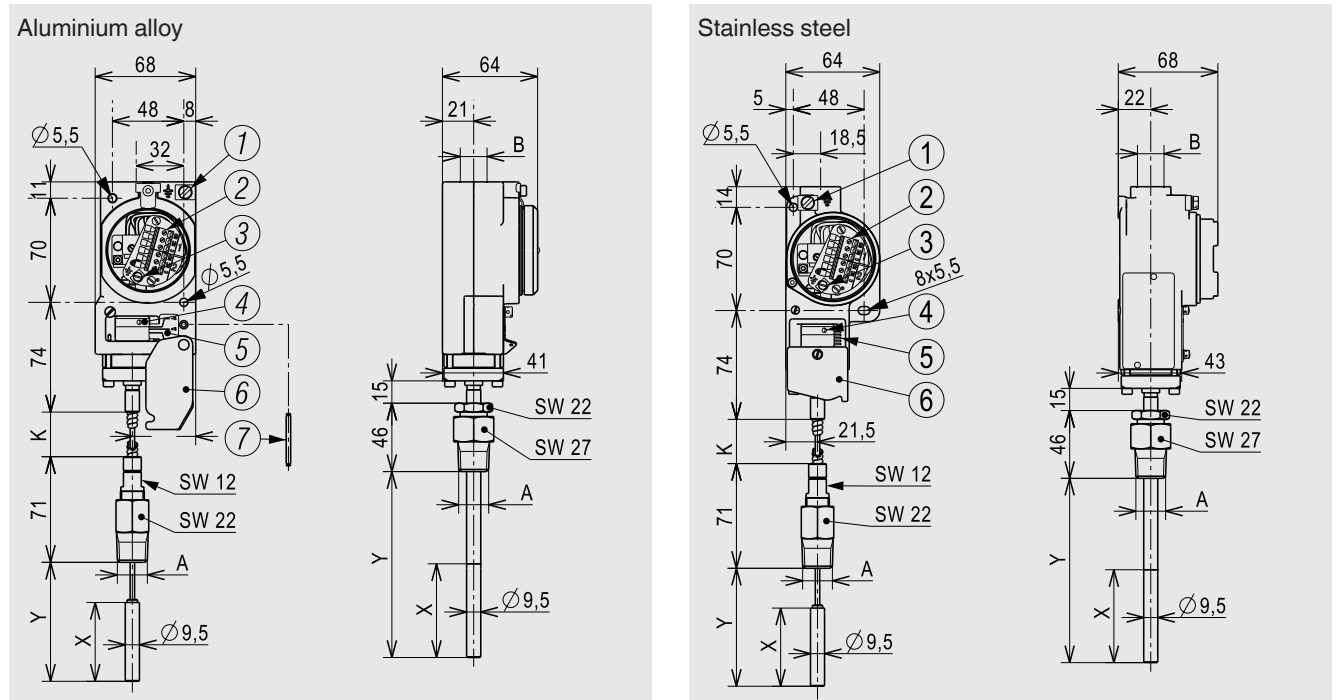

Legend

- | | | |
|-------------------------|----------------------|----------------------------|
| ① Ground screw, outside | ④ Adjustment screw | ⑦ Set point adjustment rod |
| ② Terminal block | ⑤ Calibration scale | A Process connection |
| ③ Ground screw, inside | ⑥ Access cover plate | B Electrical connection |
| SW Spanner width | | |

For dimensions A, B, K, X and Y see page 3

Permissible mounting positions



Ordering information

Model / Switch enclosure / Sensor version / Capillary length (if applicable) / Contact version / Setting range / Process connection / Electrical connection / Options

© 2009 WIKA Alexander Wiegand SE & Co. KG, all rights reserved.
The specifications given in this document represent the state of engineering at the time of publishing.
We reserve the right to make modifications to the specifications and materials.

