

5000B

User Guide

5000B Data acquisition and logging unit
Versions 3.4 and later

HA027566/11
September 2012

Declaration of Conformity

| | |
|------------------------------|--|
| Manufacturer: | Eurotherm Limited Faraday Close, Worthing, West Sussex, BN13 3PL, United Kingdom |
| Product type: | Industrial networked data acquisition unit |
| Model: | 5000B Status level A1 and above |
| Safety specification: | EN61010-1: 2001 |
| EMC emissions specification: | EN61326-1: 2006 Class A |
| EMC immunity specification: | EN61326-1: 2006 Industrial locations |

Eurotherm Limited hereby declares that the above products conform to the safety and EMC specifications listed. Eurotherm Limited further declares that the above products comply with the EMC Directive 2004/108/EC, and also with the Low Voltage Directive 2006/95/EC.

Signed: _____

Kevin Shaw

Dated: *14th September 2012*

Signed for and on behalf of Eurotherm Limited.
Kevin Shaw
(R&D Director)



IA249986U590 Issue 2 August 12 (CN28854)

© 2012 Eurotherm Limited

All rights are strictly reserved. No part of this document may be reproduced, modified, or transmitted in any form by any means, nor may it be stored in a retrieval system other than for the purpose to act as an aid in operating the equipment to which the document relates, without the prior written permission of Eurotherm Limited.

Eurotherm Limited pursues a policy of continuous development and product improvement. The specifications in this document may therefore be changed without notice. The information in this document is given in good faith, but is intended for guidance only. Eurotherm Limited will accept no responsibility for any losses arising from errors in this document.

DATA ACQUISITION AND LOGGING UNIT

USER GUIDE

LIST OF SECTIONS

Section Page

| | |
|---------------------------------|-----|
| 1 INTRODUCTION..... | 10 |
| 2 INSTALLATION..... | 10 |
| 3 PROCESS VARIABLE DISPLAY..... | 23 |
| 4 SETTING UP THE RECORDER..... | 52 |
| ANNEX A: SPECIFICATION | 123 |
| ANNEX B: REFERENCE | 129 |
| INDEX..... | 149 |

EFFECTIVITY

This manual refers to units fitted with software version 3.4. To determine the software version fitted to the data acquisition unit, the 'About' screen in the System menu may be accessed as described in [section 4.6.5](#).

ASSOCIATED DOCUMENTS

HA028121 Options manual. For options other than those included in this user guide (e.g. Auditor pack)
HA028122 Communications manual. For details of Remote Viewer and Modbus communications including the ASCII Printer Output option

LIST OF CONTENTS

| Section | Page |
|--|-----------|
| SAFETY NOTES..... | 9 |
| SYMBOLS USED ON THE EQUIPMENT LABELLING..... | 9 |
| 1 INTRODUCTION | 10 |
| 1.1 UNPACKING THE UNIT | 10 |
| 2 INSTALLATION | 10 |
| 2.1 MECHANICAL INSTALLATION | 10 |
| LED STATUS | 11 |
| 2.2 ELECTRICAL INSTALLATION | 12 |
| 2.2.1 Signal wiring | 12 |
| CONNECTOR WIRING DETAILS..... | 12 |
| 2.2.2 Supply voltage wiring | 12 |
| 2.3 PC SOFTWARE INSTALLATION AND OPERATION | 13 |
| 2.3.1 INTRODUCTION..... | 13 |
| MINIMUM PC REQUIREMENTS | 13 |
| SUPPORTED PDA CONFIGURATION | 13 |
| 2.3.2 Connection details | 14 |
| DIRECT PC CONNECTION | 14 |
| PC TO REMOTE UNIT | 14 |
| NETWORKED SYSTEMS..... | 14 |
| 2.3.3 Software installation | 15 |
| 2.3.4 Running the program..... | 15 |
| CHANNEL ALARM SOUND..... | 16 |
| 2.3.5 NETWORK CONFIGURATION | 17 |
| NETWORK | 17 |
| ACCESS | 17 |
| 2.3.6 Error messages | 18 |
| NETWORK CONNECTION HAS TIMED OUT..... | 18 |
| UNABLE TO CONNECT TO HOST | 18 |
| UNABLE TO RESOLVE HOSTNAME | 18 |
| FAILED TO AUTHENTICATE THE USER NAME AND/OR PASSWORD SUPPLIED | 18 |
| MAXIMUM REMOTE VIEWERS ALREADY CONNECTED TO | 18 |
| THERE APPEARS TO BE NO FREE DISK SPACE ON | 18 |
| YOU ARE ALREADY RUNNING A FULL REMOTE | 18 |
| YOU ARE AUTHENTICATING FULL REMOTE | 18 |
| 2.4 USING THE NETWORK CONFIGURATION PORT | 19 |
| 2.4.1 Port wiring | 19 |
| 2.4.2 Establishing connection..... | 19 |
| 2.4.3 Network settings | 21 |
| VIEW NETWORK SETTINGS | 21 |
| MODIFY NETWORK SETTINGS | 21 |
| 2.4.4 Software upgrade | 22 |
| 2.4.5 Lockout Recovery | 22 |
| 2.4.6 Start System | 22 |
| 3 PROCESS VARIABLE DISPLAY | 23 |
| TRUNCATION OF NUMERIC VALUES | 23 |
| CURRENT TRACE ALARM ICONS..... | 24 |
| 3.1 STATUS BAR..... | 24 |
| 3.1.1 Current access level | 24 |
| 3.1.2 Page name..... | 24 |
| 3.1.3 Alarm indicators | 25 |
| ALARM SUMMARY PAGE | 25 |
| ALARM ACKNOWLEDGEMENT | 26 |
| INSTRUMENT ALARM | 27 |
| CHANNEL ALARM | 27 |
| CHANGE BATTERY | 27 |
| 3.1.4 FTP Icon..... | 28 |

Cont...

LIST OF CONTENTS (Cont.)

| Section | Page |
|---|----------------|
| 3.1.5 Configuration Locked indicator | 28 |
| 3.2 NAVIGATION KEYS | 28 |
| 3.2.1 Key functions | 28 |
| ROOT MENU KEYS | 29 |
| MESSAGE LOG | 30 |
| 3.3 FIRST SWITCH-ON | 32 |
| 3.3.1 Access to Configuration | 33 |
| TEXT STRING ENTRY..... | 34 |
| 3.4 DISPLAY MODES | 36 |
| 3.4.1 Vertical Trend display | 36 |
| TIME CHANGE RECORDS..... | 37 |
| TREND HISTORY | 37 |
| 3.4.2 Horizontal Trend display..... | 39 |
| 3.4.3 Vertical bargraph..... | 41 |
| FACEPLATES ABOVE THE BARS | 41 |
| FACEPLATES AT RIGHT-HAND EDGE..... | 41 |
| 3.4.4 Horizontal bargraph | 43 |
| 3.4.5 Numeric | 45 |
| 3.4.6 Circular Trend Option | 47 |
| TREND MODES..... | 47 |
| NORMAL VIEW | 48 |
| NORMAL VIEW FEATURES | 49 |
| FULL SCREEN DISPLAY | 49 |
| FULL SCREEN FEATURES..... | 49 |
| TIMESTAMPS | 50 |
| OTHER NOTES | 50 |
| 3.5 OPERATOR NOTES | 51 |
| 4 SETTING UP THE DATA ACQUISITION UNIT | 52 |
| 4.1 ARCHIVE | 53 |
| 4.2 SAVE / RESTORE..... | 54 |
| 4.2.1 Save..... | 54 |
| SAVE FOR PRE VERSION 1.8 | 54 |
| 4.2.2 Restore | 55 |
| 4.2.3 New..... | 55 |
| 4.2.4 Text | 55 |
| 4.2.5 Import screen | 55 |
| 4.2.6 Export screen | 55 |
| 4.2.7 Import User Linearisation | 56 |
| 4.2.8 Export User Linearisation | 56 |
| 4.2.9 Import printer driver | 56 |
| 4.3 CONFIGURATION | 57 |
| 4.3.1 Instrument configuration | 60 |
| INSTRUMENT NAME..... | 60 |
| MODBUS ADDRESS..... | 60 |
| MODBUS SECURITY DISABLED | 60 |
| COMMS CHANNEL TIMEOUT | 60 |
| PRESET HOUR..... | 60 |
| PRESET MINUTE | 60 |
| DISABLE WARNING DIALOGS | 60 |
| 4.3.2 Group configuration..... | 61 |
| GROUP NUMBER..... | 62 |
| TREND UNITS | 62 |
| DESCRIPTOR..... | 62 |
| TREND TYPE | 62 |
| A/B SWITCHING | 63 |
| TREND SPEED/TREND INTERVAL..... | 63 |
| CIRCULAR SETTINGS | 63 |
| | Cont... |

LIST OF CONTENTS (Cont.)

| Section | Page |
|--|-----------|
| 4.3.2 Group configuration (Cont.) | |
| CIRCULAR SPEED | 63 |
| CIRCULAR CHART FULL | 63 |
| START AT | 63 |
| GRID TYPE | 64 |
| RECORDING ENABLE | 64 |
| RECORDING SPEED/RECORDING INTERVAL | 65 |
| TREND HISTORY DURATION | 65 |
| ARCHIVE VIA FTP | 65 |
| ALARM MESSAGE | 65 |
| ACK MESSAGE | 65 |
| GROUP CONTENTS | 65 |
| 4.3.3 Channel/Alarm configuration | 66 |
| CHANNEL NUMBER | 67 |
| VALUE | 67 |
| INPUT TYPE | 67 |
| LIN TYPE | 67 |
| INPUT LOW | 67 |
| INPUT HIGH | 67 |
| SHUNT | 67 |
| RANGE LOW | 68 |
| RANGE HIGH | 68 |
| RANGE UNITS | 68 |
| SCALED | 68 |
| OFFSET | 68 |
| SCALE TYPE | 69 |
| FILTER | 70 |
| BREAK RESPONSE | 70 |
| COLD JUNCTION COMPENSATION (CJC) | 70 |
| DESCRIPTOR | 70 |
| A/B SWITCHING | 70 |
| SPANNED | 71 |
| ZONE | 71 |
| PV FORMAT | 71 |
| MAXIMUM DECIMAL DIGITS | 71 |
| COLOUR | 71 |
| ALARM NUMBER | 72 |
| ENABLE | 72 |
| TYPE | 72 |
| PARAMETERS | 73 |
| EXAMPLE | 73 |
| JOB NUMBER | 75 |
| CATEGORY | 75 |
| WHILE/ON | 75 |
| ALARM MESSAGES | 75 |
| 4.3.4 Views Configuration | 76 |
| HOME TIMEOUT | 76 |
| HOME GROUP | 76 |
| DARK TREND/DARK HISTORY BACKGROUND | 76 |
| SCOPE | 77 |
| GROUP | 77 |
| DISPLAY ENABLE | 77 |
| HOME PAGE | 77 |
| DISPLAY MODE ENABLING | 77 |
| USER SCREENS 1 to N | 78 |
| 4.3.5 Archive configuration | 79 |
| COMPRESSION | 79 |
| FLASH SIZE | 79 |
| SHORTEST TREND HISTORY / DURATION | 79 |
| CSV CHECKBOXES, DATE/TIME FORMAT | 80 |
| FTP FILE FORMAT | 80 |
| ARCHIVE TO REMOTE | 80 |

Cont...

LIST OF CONTENTS (Cont.)

| Section | Page |
|--|-----------|
| 4.3.5 Archive configuration (Cont.) | |
| REMOTE PATH | 80 |
| PRIMARY REMOTE HOST | 80 |
| PRIMARY LOGIN NAME/PASSWORD | 80 |
| SECONDARY REMOTE HOST/LOGIN/PASSWORD | 80 |
| CSV OPTION | 81 |
| 4.3.6 Event configuration..... | 83 |
| EVENT NUMBER | 83 |
| SOURCE TYPES | 83 |
| EVENT SOURCES (Cont.) | 84 |
| SOURCE 1 SENSE | 84 |
| OPERATOR | 85 |
| SOURCE 2 SENSE | 85 |
| DESCRIPTOR | 85 |
| JOB NUMBER | 85 |
| CATEGORY | 85 |
| WHILE/ON | 85 |
| EVENT EXAMPLE | 85 |
| 4.3.7 Event Buttons | 86 |
| 4.3.8 Messages | 87 |
| MESSAGE ENTRY | 87 |
| CONFIGURABLE PARAMETERS | 87 |
| EXAMPLE | 89 |
| 4.3.9 User Linearisation Tables | 90 |
| CONFIGURATION PARAMETERS | 90 |
| CONFIGURATION PARAMETERS (Cont.) | 91 |
| 4.3.10 Options | 92 |
| 4.4 SECURITY | 93 |
| 4.4.1 Access levels | 94 |
| SETTING PERMISSIONS | 94 |
| ACCESS WHEN: | 95 |
| NEW PASSWORD/RETYPE PASSWORD | 95 |
| CONNECT FROM REMOTE | 95 |
| REMOTE USER NAME/PASSWORD | 95 |
| LOGIN DISABLED | 95 |
| EDIT OWN PASSWORD | 95 |
| CHANGE ALARM SETPOINTS | 95 |
| ACKNOWLEDGE ALARMS | 95 |
| EDIT MATHS CONSTANT | 95 |
| RESET MATHS | 96 |
| PRESET TOTALISERS | 96 |
| PRESET COUNTERS | 96 |
| START/RESET TIMERS | 96 |
| SET CLOCK | 96 |
| ADJUST INPUTS | 96 |
| ARCHIVING CONTROL | 96 |
| SAVE/RESTORE | 96 |
| FULL CONFIGURATION | 96 |
| FULL SECURITY | 96 |
| BATCH CONTROL | 96 |
| CAN SIGN | 96 |
| CAN AUTHORIZE | 97 |
| EVENT PERMISSION 1 | 97 |
| EVENT PERMISSION 2 TO 5 | 97 |
| EDIT OUTPUT CHANNEL DEFAULTS | 97 |
| ACTION DEMAND WRITES | 97 |
| FORCE CHANGE OF PASSWORD | 97 |
| 4.4.2 Management (option) | 98 |
| CHANGES NOT RECORDED | 98 |
| CONFIGURABLE PARAMETERS | 98 |
| CONFIGURABLE PARAMETERS (Cont.) | 99 |

Cont...

LIST OF CONTENTS (Cont.)

| Section | Page |
|------------------------------------|-------------|
| 4.4.3 Add user..... | 102 |
| NEW USER ID..... | 102 |
| NEW FULL USER NAME..... | 102 |
| NEW PASSWORD/RETYPE PASSWORD..... | 102 |
| BASED ON..... | 102 |
| 4.4.4 Remove user..... | 102 |
| 4.5 NETWORK KEY..... | 103 |
| 4.5.1 Address..... | 103 |
| INSTRUMENT NUMBER/MAC ADDRESS..... | 103 |
| IP ADDRESS LOOKUP..... | 103 |
| BOOTP TIMEOUT..... | 103 |
| IP ADDRESS..... | 103 |
| SUBNET MASK..... | 103 |
| DEFAULT GATEWAY..... | 104 |
| SNTP ENABLE..... | 104 |
| SNTP SERVER..... | 104 |
| 4.5.2 Name..... | 105 |
| LOCAL HOST..... | 105 |
| DOMAIN..... | 105 |
| DOMAIN NAME SERVICE (DNS)..... | 105 |
| PRIMARY/SECONDARY DNS SERVER..... | 105 |
| 4.6 SYSTEM..... | 106 |
| 4.6.1 Clock..... | 107 |
| 4.6.2 Locale..... | 107 |
| 4.6.3 Keycode..... | 107 |
| 4.6.4 Input adjust..... | 107 |
| ADJUST PROCEDURE..... | 109 |
| 4.6.5 About..... | 110 |
| INSTRUMENT VARIANT..... | 110 |
| CONFIG REVISION..... | 110 |
| LAST UPDATED..... | 110 |
| AT VERSION..... | 110 |
| SECURITY REVISION..... | 111 |
| SUPPORT FILE..... | 111 |
| CLEAN \USER FOLDER..... | 111 |
| 4.6.6 Comms Diagnostics..... | 112 |
| 4.6.7 Copy..... | 112 |
| CONFIGURABLE PARAMETERS..... | 112 |
| COPY RULES..... | 113 |
| 4.7 JOBS..... | 114 |
| 4.7.1 No Action..... | 114 |
| 4.7.2 Drive relay..... | 114 |
| 4.7.3 Totaliser category..... | 115 |
| 4.7.4 Message category..... | 115 |
| 4.7.5 Maths category..... | 116 |
| 4.7.6 Clock category..... | 116 |
| 4.7.7 Counter category..... | 117 |
| 4.7.8 Timer category..... | 117 |
| 4.7.9 Batch Category..... | 117 |
| 4.7.10 Recording category..... | 118 |
| 4.7.11 Trend category..... | 118 |
| 4.7.12 Output category..... | 119 |
| 4.7.13 Demand Writes category..... | 119 |
| 4.7.14 Alarm category..... | 120 |
| 4.7.15 Archive category..... | 120 |
| 4.7.16 Email category..... | 121 |

Cont...

LIST OF CONTENTS (Cont.)

| Section | Page |
|---|------------|
| 4.7.17 Report Category | 121 |
| SEND REPORT TO | 121 |
| GROUP | 121 |
| REPORT | 121 |
| ANNEX A: SPECIFICATION..... | 123 |
| INSTALLATION CATEGORY AND POLLUTION DEGREE | 123 |
| Installation category II | 123 |
| Pollution degree 2..... | 123 |
| TECHNICAL SPECIFICATION (ACQUISITION UNIT) | 124 |
| TECHNICAL SPECIFICATION (UNIVERSAL INPUT BOARD) | 126 |
| TECHNICAL SPECIFICATION (RELAY OUTPUT BOARD) | 128 |
| TECHNICAL SPECIFICATION (EVENT INPUT BOARD) | 128 |
| TECHNICAL SPECIFICATION (ASCII PRINTER) | 128 |
| ANNEX B: REFERENCE | 129 |
| B1 PREVENTIVE MAINTENANCE | 129 |
| B1.1 MAINTENANCE SCHEDULE | 129 |
| B1.2 BATTERY REPLACEMENT PROCEDURE | 129 |
| B2 OPTION ENABLING | 131 |
| B2.1 INSTRUMENT NUMBER | 131 |
| B2.2 KEY CODE..... | 131 |
| B2.3 KEY CODE FILE..... | 131 |
| B3 COLOUR SELECTION..... | 132 |
| B4 TCP PORT NUMBERS | 134 |
| B5 ASCII CHARACTERS FOR SERIAL COMMS..... | 135 |
| B6 TIME ZONES | 136 |
| B7 JOB TRIGGER LIST | 137 |
| B8 MENU STRUCTURE..... | 139 |
| INDEX..... | 149 |

This page is deliberately left blank

SAFETY NOTES

WARNING

Any interruption of the protective conductor inside or outside the apparatus, or disconnection of the protective earth terminal is likely to make the apparatus dangerous under some fault conditions. Intentional interruption is prohibited.

Note: in order to comply with the requirements of safety standard BS EN61010, the equipment shall have one of the following as a disconnecting device, fitted within easy reach of the operator, and labelled as the disconnecting device.





- a. A switch or circuit breaker which complies with the requirements of IEC947-1 and IEC947-3
- b. A separable coupler which can be disconnected without the use of a tool
- c. A separable plug, without a locking device, to mate with a socket outlet in the building.

1. Before any other connection is made, the protective earth terminal shall be connected to a protective conductor. The supply voltage cable must be terminated in such a way that, should it slip, or be pulled out, the Earth wire would be the last wire to become disconnected.
3. The supply fuse within the power supply is not replaceable. If it is suspected that the fuse is faulty, the manufacturer's local service centre should be contacted for advice.
4. Whenever it is likely that protection has been impaired, the unit shall be made inoperative, and secured against accidental operation. The manufacturer's nearest service centre should be contacted for advice.
5. Any adjustment, maintenance and repair of the opened apparatus under voltage, should be avoided as far as possible and, if inevitable, shall be carried out only by a skilled person who is aware of the hazard involved.
6. Where conductive pollution (e.g. condensation, carbon dust) is likely, adequate air conditioning/filtering/sealing etc. must be installed in the equipment enclosure.
7. Signal and supply voltage wiring should be kept separate from one another. Where this is impractical, shielded cables should be used for the signal wiring.
8. If the equipment is used in a manner not specified by the manufacturer, the protection provided by the equipment might be impaired.

* A full definition of 'Hazardous' voltages appears under 'Hazardous live' in BS EN61010. Briefly, under normal operating conditions, hazardous voltages are defined as being $> 30V$ RMS (42.2V peak) or $> 60V$ dc.

SYMBOLS USED ON THE EQUIPMENT LABELLING

One or more of the symbols below may appear as a part of the unit's labelling.

| | |
|---|--------------------------------------|
|  | Refer to the manual for instructions |
|  | Protective earth |
|  | This recorder for dc supply only |
|  | Risk of electric shock |

USER GUIDE

1 INTRODUCTION

This document describes the installation, operation and configuration of a data acquisition and logging unit. The unit is intended for remote operation using an Ethernet link, and is configured and operated from a PC running proprietary software.

The unit can be wall mounted (using back face), or secured using a T35 DIN rail (back face or end face). The unit's instrument time can be updated from a unicast (i.e. point-to-point) Simple Network Time Protocol (SNTP) server and is also itself an SNTP server. SNTP time is based on elapsed seconds since 00:00 hrs. on 1st Jan 1900 GMT and is affected neither by time zones nor by daylight saving. The relevant TCP port number is 123. See sections 4.3.1 ([Instrument configuration](#)), 4.5.1 ([Network Address configuration](#)) and [B6 in Annex B](#) for more details.

1.1 UNPACKING THE UNIT

The unit is despatched in a special pack, designed to give adequate protection during transit. Should the outer box show signs of damage, it should be opened immediately, and the unit examined. If there is evidence of damage, the instrument should not be operated and the local representative contacted for instructions. After the unit has been removed from its packing, the packing should be examined to ensure that all accessories and documentation have been removed. The packing should then be stored against future transport requirements.

2 INSTALLATION

2.1 MECHANICAL INSTALLATION

Figure 2.1a shows how to fix the securing bracket to the unit, and how to convert from wall mounting to DIN rail mounting. Figure 2.1b gives installation details for the unit.

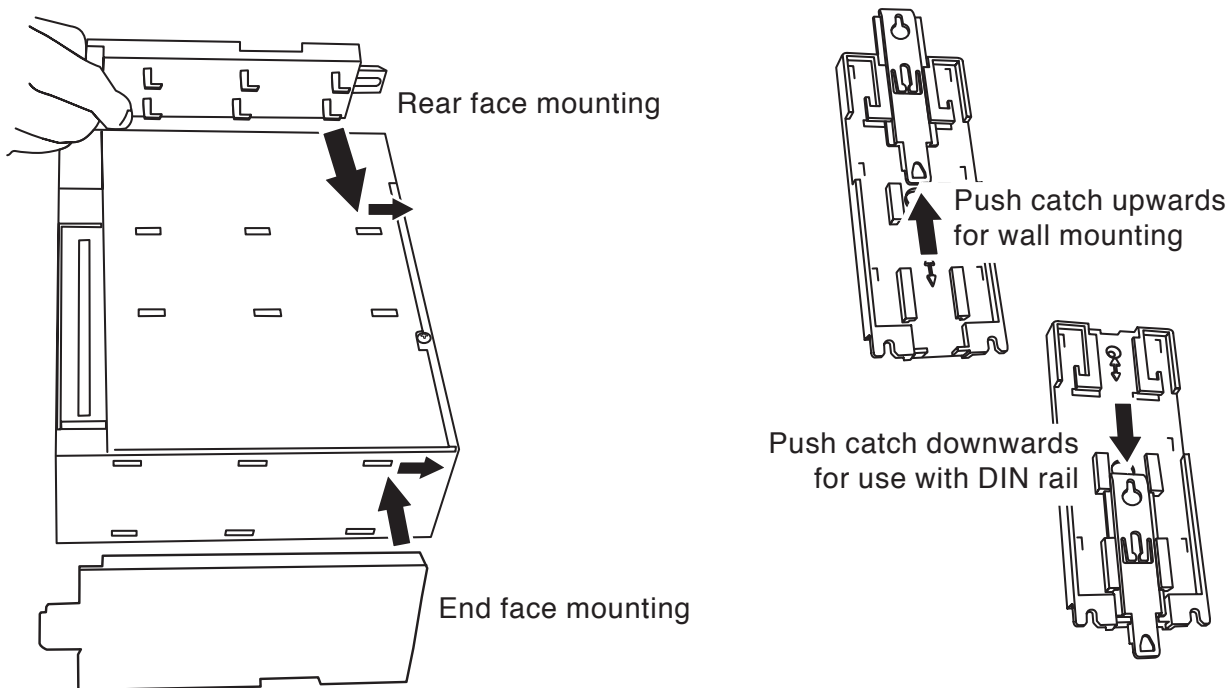

Figure 2.1a Mounting bracket details

2.1 MECHANICAL INSTALLATION (Cont.)

Notes:

- 1 When wall mounted, the front face of the unit is 79 mm from the wall.
When DIN-Rail mounted, the front face of the unit is 73.5 mm from the front face of the rail.
- 2 For thermocouple inputs, the connectors must be horizontal to achieve specified thermal performance.

LED STATUS

Table 2.1 gives details of the two LEDs located near the top of the right-hand side of the unit

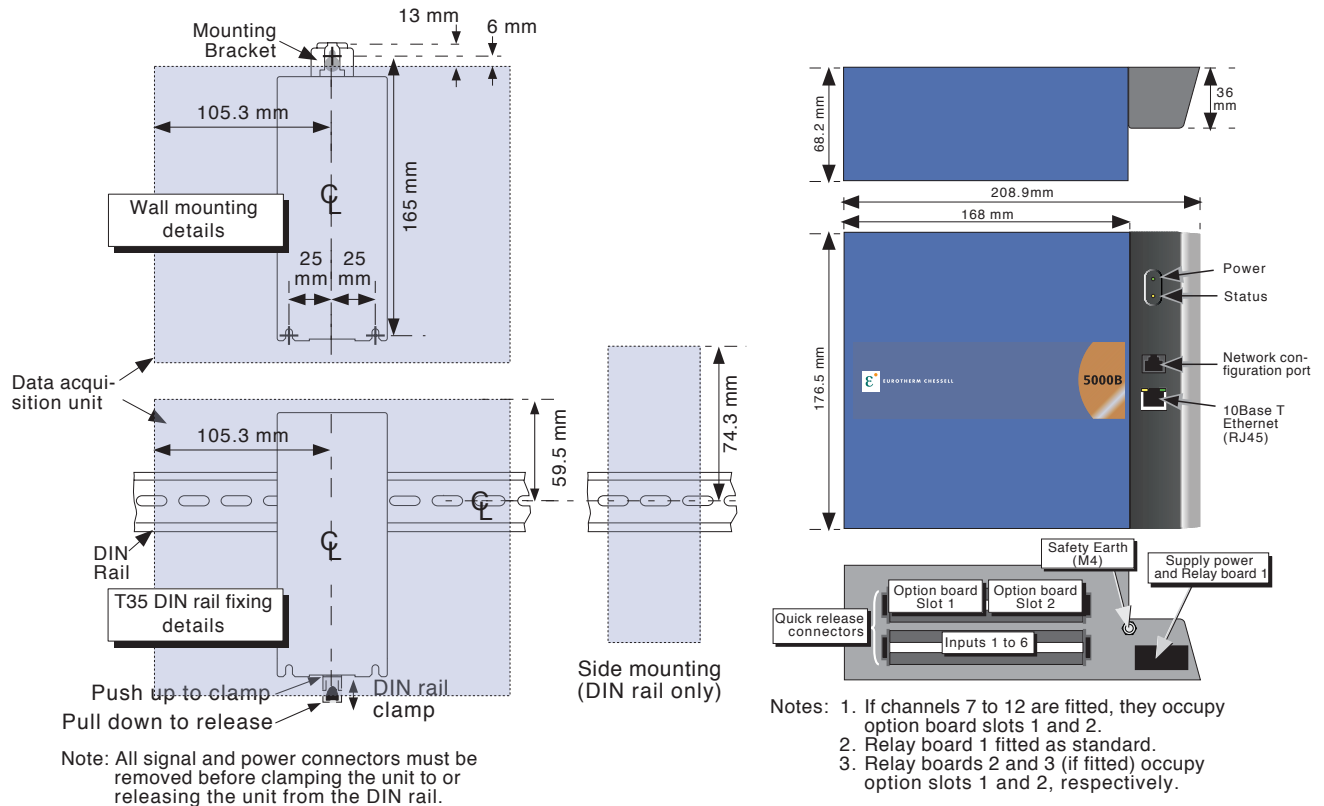

Figure 2.1b Mechanical installation details

| LED state | Definition |
|---------------------------------------|----------------------|
| Off | System running |
| On | System error |
| Rapid flash | Network boot failure |
| Slow flash | System booting up. |
| Rapid flash = 250msec on; 250msec off | |
| Slow flash = 500msec on; 500msec off | |

Yellow (status) LED data

| LED state | Definition |
|-----------|------------------------|
| Off | Power off |
| On | Supply power available |

Green (power) LED data

Table 2.1 LED status definitions

2.2 ELECTRICAL INSTALLATION

2.2.1 Signal wiring

Figure 2.1b, above, shows connector locations. Figure 2.2.1, below, gives pinouts.

CONNECTOR WIRING DETAILS

- Maximum wire size = 4.13mm² (11 AWG)
- Minimum wire size = 0.081mm² (28 AWG)
- Design torque = 0.8Nm.

2.2.2 Supply voltage wiring

Note: The recommended minimum wire size is 16/0.2 (0.5mm²) (20 AWG).

Supply voltage is terminated at a connector located at the base of the unit as shown in figure 2.1b, above. The unit is suitable for use with all dc voltages between 18 and 30 V dc. Maximum power consumed is 10W. The safety Earth connection is an M4 nut/stud located adjacent to the supply connector (figure 2.1b). Pinout is as shown below.

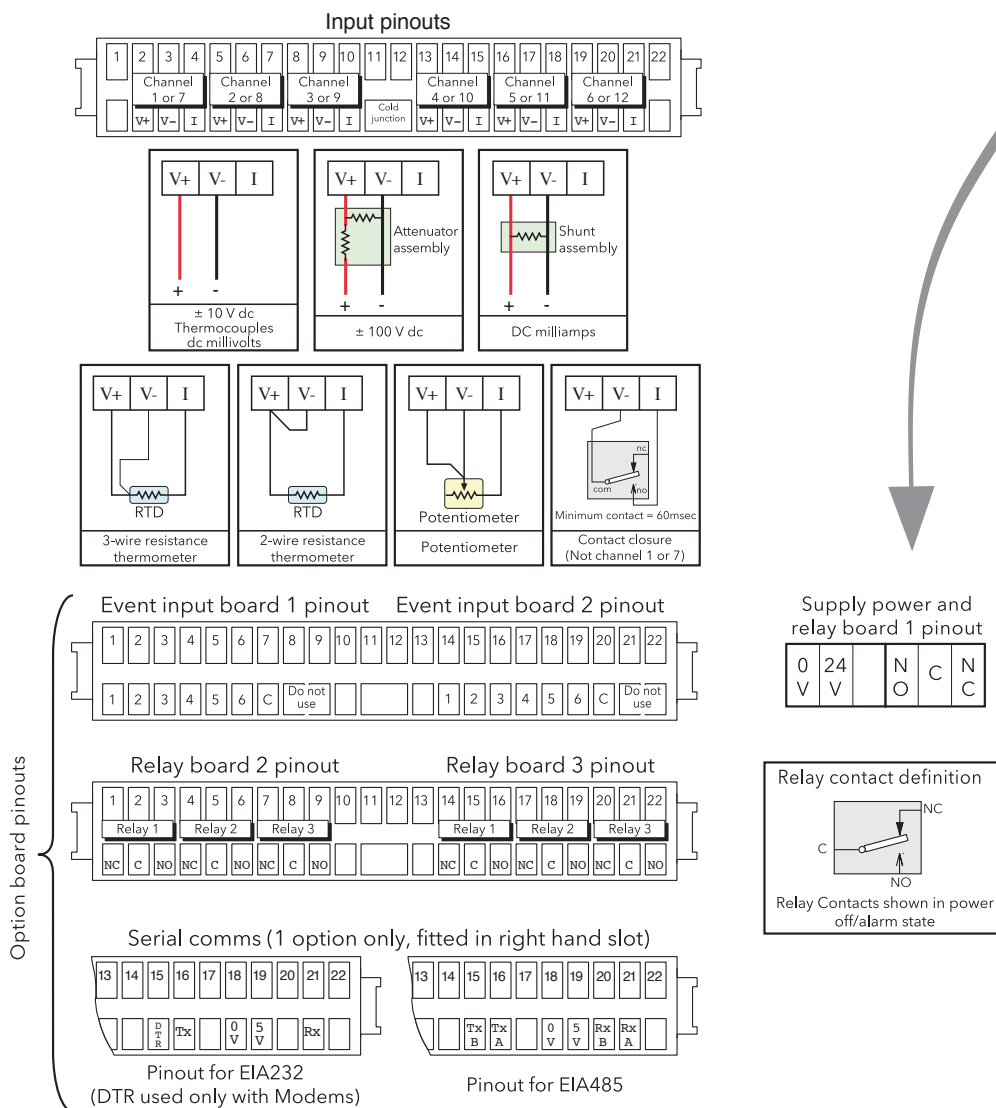

Figure 2.2.1 Pinout details

2.3 PC SOFTWARE INSTALLATION AND OPERATION

2.3.1 INTRODUCTION

Operation and configuration of the of the unit is possible, simultaneously, from up to four PCs which meet or exceed the minimum requirements listed below. When a change is being made to the configuration of the unit by one Remote Viewer user ('client'), the message:

```
Feature Locked
```

```
Another client (IP ADDRESS) has locked this feature.
```

```
Wait for lock to be released and try again
```

appears in the screen window of any other user who attempts to change the configuration. When changes are complete, the message:

```
Feature changed
```

```
Synchronising data
```

appears in the screen windows of all clients (except that of the one making the change).

The software is supplied on a CD ROM, which also includes PC Review, PC Configuration and Acrobat reader software and various manuals relevant to the data acquisition/logging unit.

The Remote viewer software is suitable for any physical hardware configurations, some common examples being:

1. A single PC connected directly to the unit.
2. Multiple PCs connected via a network to one or more units. (Each unit can be accessed, simultaneously, by a maximum of four PCs, but one PC can look at a number of units depending on available memory. For example, a minimum specification computer running Windows NT can 'look at' up to three data acquisition/logging units at the same time.)
3. A single PC connected via a telephone line to a remote data acquisition/logging unit.

Notes:

1. When logging in from a remote viewer, only users with 'Connect from Remote' enabled appear in the user list. See section 4.4.1 for details.
 2. Full Remote Viewer requires some small amount of space on the pc disk. The message 'There appears to be no free disk space on the client. Create some space and run again.' appears if there is insufficient space.
 3. If an attempt is made to establish more than one Full Remote Viewer connection between a PC and the unit, the message 'You are already running a Full Remote Viewer session to this instrument. The session will now run as a Lite Remote Viewer.' appears. This means that the new connection will be read-only.
 4. If an attempt is made to establish a Remote Viewer connection using the 'anonymous' user name, the message 'You are authenticating Full Remote Viewer using the "anonymous" user name. This provides guest read only access. For Full remote Viewer you must use a different user name. Change and try again.' appears.
-

MINIMUM PC REQUIREMENTS

1. P90 running Windows NT/2000/ME/XP
2. 32MB RAM
3. 50MB free hard disk space
4. Graphics drive capable of displaying > 256 colours (recommended)
5. Sound card required for audible alarms feature ([section 2.3.4](#))

SUPPORTED PDA CONFIGURATION

Compaq iPAQ 3850 with Jeode EVM version 1.9.

2.3.2 Connection details

The connection to the unit is terminated at the RJ45 connector located as shown in figure 2.1b. The other end of the cable may be terminated, for example, at a hub, a dial-up router or a PC, and it is up to the user to obtain a suitable cable (normally available from a computer supplier or electronic component distributor.)

Note: For direct connection between a PC and the unit, a crossover cable is required. For all other connections, a 'straight-through' connection is required.

DIRECT PC CONNECTION

The unit's RJ45 connector is connected via a crossover cable to the PC network card connector.

PC TO REMOTE UNIT

As shown in figure 2.3.2, one or more units' Ethernet connectors can be connected to a Dial Up Router, plugged into a telephone socket. The PC must similarly be connected to a telephone socket via a modem (shown externally in the figure, but often built-in with modern computers.)

The dial-up router (available from computer suppliers etc.) has an associated telephone number, and can also have a security password system. Both the telephone number and any password(s) must be known to the PC user before any attempt at communication is made.

The PC can be set up to dial the number automatically, or the number may be dialled manually. Reference should be made to the computer documentation or help pages if necessary.

Once communication has been established, the software can be run.

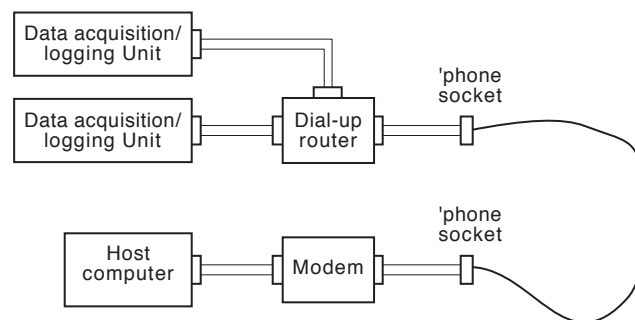

Figure 2.3.2 Remote connection example

NETWORKED SYSTEMS

For PCs and units connected into an internal network, it is necessary only to obtain an IP address (or name) and the required passwords in order to establish connections between the PC(s) and the unit(s).

For PCs remote from a networked system which is permanently connected to the internet, it is necessary to obtain an IP address (or name) and the required passwords in order to establish connections between the PC and the instrument(s). In many cases it is also necessary that the internal network and 'firewall' (if such exists) be configured so as to allow access.

For PCs remote from a networked system which is not connected to the internet, a system similar to that shown in figure 2.3.2 is needed.

2.3.3 Software installation

Please refer to the CD box insert for details of software installation.

2.3.4 Running the program

Initiate the program using the START button in the normal way. A Host name and User name are requested as depicted in figure 2.3.4a. Initially, enter Host name: 192.168.111.222, and User Name = Engineer. The password required box should be left unchecked. Subsequently, the host name/user name etc. can be modified as described in section 2.3.5, below.

Clicking 'Start as Lite', allows the user to select the 'View only' version of the Remote Viewer. This has the advantage of faster operation.

Notes

- 1 If frequent use is to be made of this option, it is recommended that a 'short-cut' be created, and placed on the computer desktop. To create a new Remote Viewer link: right click on the desktop, left click 'New' in the pop up menu which appears, then left click on the Remote Viewer icon. When naming Remote Viewer files, the extension .uhv must be used.
- 2 If the PC locale setting (e.g. Daylight Saving Time) does not match that set in the unit (System/Locale), the displayed time will be incorrect
- 3 As an alternative to the default host name/user name combination described here, it is possible to view and edit network settings using the Network Configuration Port, as described in section 2.4, below.
- 4 If an attempt is made to start the program whilst another user is configuring the unit, a 'Feature Locked' message appears. As soon as the other client 'Saves' or 'Discards' the new configuration, the message disappears and the program continues its startup.

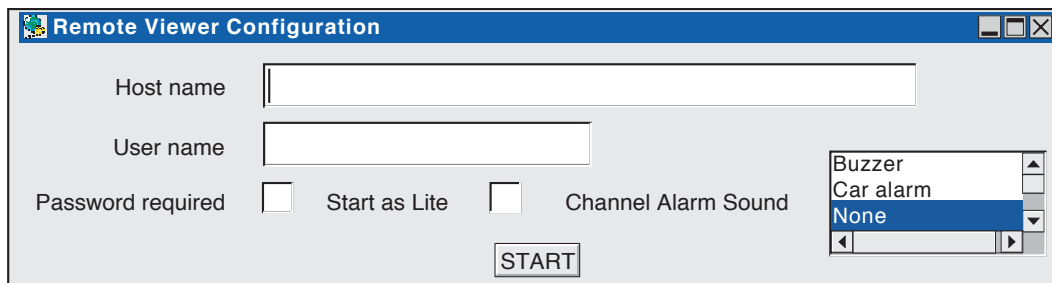

Figure 2.3.4a Profile (uhv file)

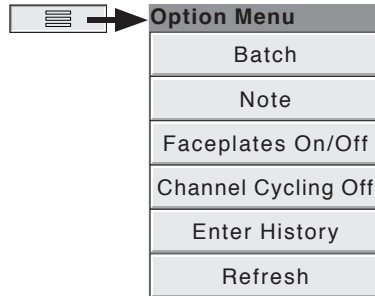

Figure 2.3.4b Remote Viewer icon (approximation)

2.3.4 RUNNING THE PROGRAM (Cont.)

The program starts, and some seconds later, the 'home' page (section 4.3.4) is displayed. The access level is 'Logged out'.

Note: When resizing the pc 'window', it may be necessary to refresh the display using the Option Key menu.



CHANNEL ALARM SOUND

If the host PC is fitted with a sound card (enabled), bridge can cause sounds to be played on point alarm (not system alarms). The sound is selected on a connection-by-connection basis via the profile (uhv) file (see figure 2.3.4a). This allows each user to choose a sound (including none) suited to the local environment.

The sound runs for as long as any point alarm is active.

Remote viewer software supplies a range of sounds as listed below. In addition, eight-bit, mono, μ Law-format .AU sound files can be imported to "<install location>/series5000/system/sounds". Once a sound has been imported, create or edit the profile (UHV) file. The new file should appear in the list. Select it and start.

The default sounds are:

1. Buzzer
2. Car Alarm
3. None
4. Police Siren
5. Siren, Fast
6. Siren, Slow
7. Something wrong
8. Train bell

2.3.5 NETWORK CONFIGURATION

NETWORK

Initially, the default settings of the unit allow one-to-one connection between it, and a PC running Remote Viewer software. These default settings are:

IP address: 192.168.111.222

Subnet mask: 255.255.255.0

Once a connection has been established, the network settings can be reconfigured to those required, as described in [section 4.5](#) of this manual.

As an alternative, the Network Configuration port can be used to configure the network settings, as described in [section 2.4](#).

ACCESS

Each of the access levels and user IDs has 'Connect from Remote' access enabled. Initially, the Remote User Name is the same as the login name or access level. Enter the required User name and password, then re-type the password to ensure it was entered correctly. This name and password are required when establishing connection with the host computer. [Figure 2.3.5](#) shows a sample configuration page. For full details see [section 4.4.1](#) of this manual.

Notes:

1. For units with the Auditor Pack Option fitted, the minimum password length is that set in the Security/Management menu described in [section 4.4.2](#). For all units, the maximum password length is 20 characters.
2. For maximum security, it is recommended that the remote password and the local password are non-identical.

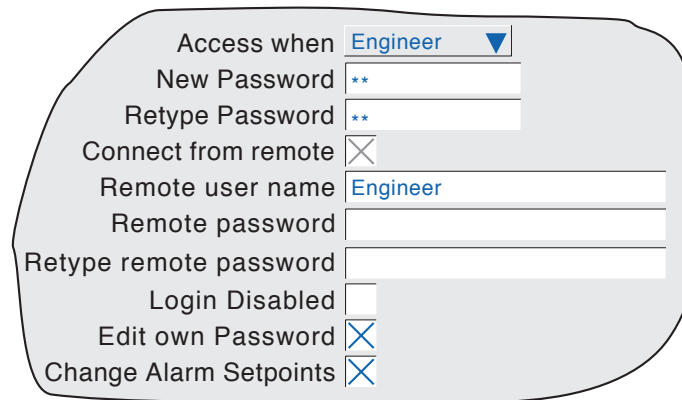

| | |
|------------------------|-------------------------------------|
| Access when | Engineer ▼ |
| New Password | ** |
| Retype Password | ** |
| Connect from remote | <input checked="" type="checkbox"/> |
| Remote user name | Engineer |
| Remote password | |
| Retype remote password | |
| Login Disabled | <input type="checkbox"/> |
| Edit own Password | <input checked="" type="checkbox"/> |
| Change Alarm Setpoints | <input checked="" type="checkbox"/> |

Figure 2.3.5 Remote user access fields

2.3.6 Error messages

A number of error conditions may occur to prevent the remote viewer from 'viewing' the data acquisition unit. The following messages can appear:

NETWORK CONNECTION HAS TIMED OUT

This message appears when no connection can be established between the remote viewer and the instrument. This might be caused by, for example, cable failure, the instrument's not being powered, network hardware failure etc.

UNABLE TO CONNECT TO HOST ...

Similar to the timeout message above, but with the additional cause: incorrect host address.

UNABLE TO RESOLVE HOSTNAME

Caused by an incorrect host address, or network failure.

FAILED TO AUTHENTICATE THE USER NAME AND/OR PASSWORD SUPPLIED

Caused by incorrect user name or password.

MAXIMUM REMOTE VIEWERS ALREADY CONNECTED TO ...

An attempt is being made to connect more remote viewers to the unit than are configured in the Options menu.

THERE APPEARS TO BE NO FREE DISK SPACE ON ...

Appears if there is insufficient space on the PC hard disk.

YOU ARE ALREADY RUNNING A FULL REMOTE ...

Appears if the pc is already connected to the instrument and running Full Remote Viewer. The new 'lite' connection will be read only.

YOU ARE AUTHENTICATING FULL REMOTE ...

Only 'Lite' Remote viewer is accessible to users using 'Anonymous'. Connection is read only.

2.4 USING THE NETWORK CONFIGURATION PORT

The network configuration port (see [figure 2.1b](#) for location) is used to configure the network settings, to carry out software upgrade and to recover from a lock-out situation which has arisen through password timeout, or because the maximum number of attempts at entering the Engineer level password has been exceeded.

Note: When this port is not in use, the dust cover supplied with the unit must be fitted

2.4.1 Port wiring

A serial cable is used to connect between one of the pc's comms ports (e.g. COM1, COM2) and the network configuration port (RJ11). See [figure 2.4.1](#) for details. A suitable cable is available from the supplier.

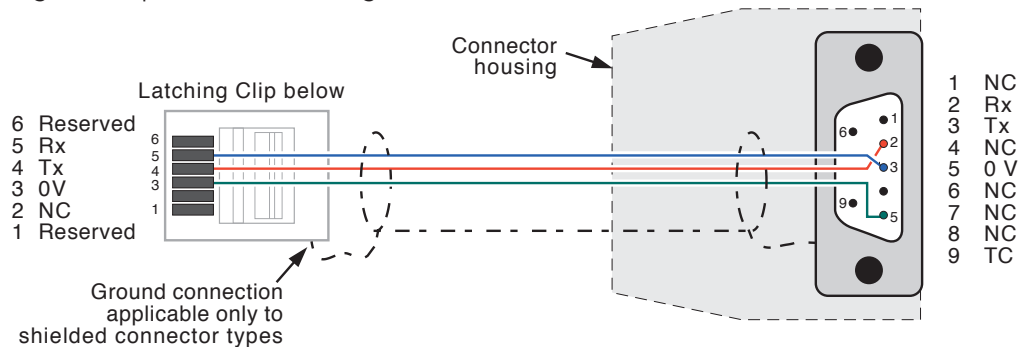

Figure 2.4.1 Serial cable details

2.4.2 Establishing connection

Using hyperterminal, or a similar terminal emulation program,

- 1 Enter a suitable name (e.g. DAU setup).
- 2 Select the pc comms port to which the Data Acquisition Unit is to be connected (e.g. COM1)
- 3 Set Baud rate = 9600; Data bits = 8; Parity = none; Stop bits = 1; Flow control = none.

Then connect the selected pc comms port to the network configuration port using a suitable cable. Disconnect any network connection to the RJ45 Ethernet connector. Whilst monitoring the Hyperterminal window, apply power to the Data Acquisition Unit. The unit starts to boot up, and the message: `System starting : S/W Version n.n` etc. appears, with a new dot appearing every 1/4 second or so. When the system has booted, the message:

`Press space bar for Setup Menus` appears, together with a 3-second count-down timer. If the space bar has not been operated within three seconds, the process stops, and the unit has to be 'power cycled' in order to return to the set up process.

If the Space bar is operated within the count-down period, the Top Level setup menu appears:

*** Setup Menu ***

- 1 : Network Settings
- 2 : Software upgrade
- 3 : Lockout Recovery
- 4 : Start System

Enter an option number :

2.4.2 ESTABLISHING CONNECTION (Cont.)

Note: Access to the setup menus can be enabled/disabled using a link on the control board, as shown in figure 2.4.2, below.

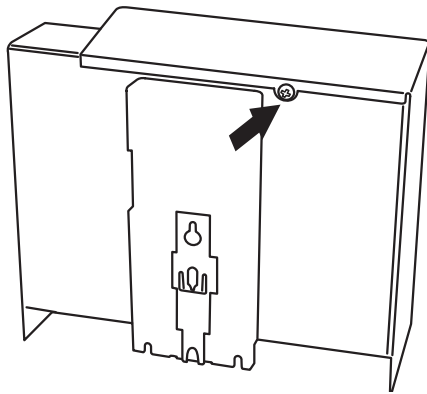

Demount the unit, then release the cover by undoing the retaining screw

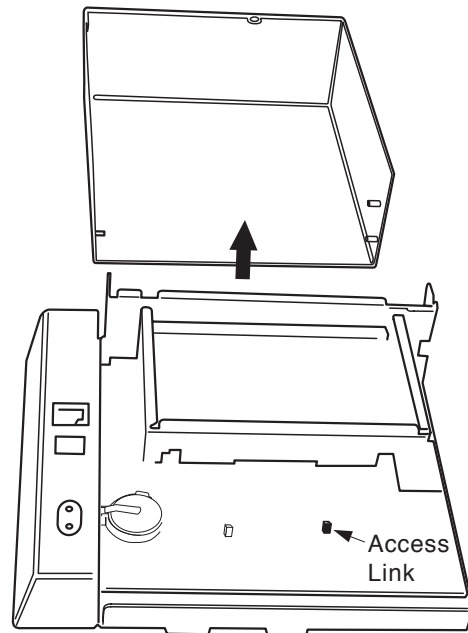

Remove the cover to reveal the control board.

Set the Link to the required position

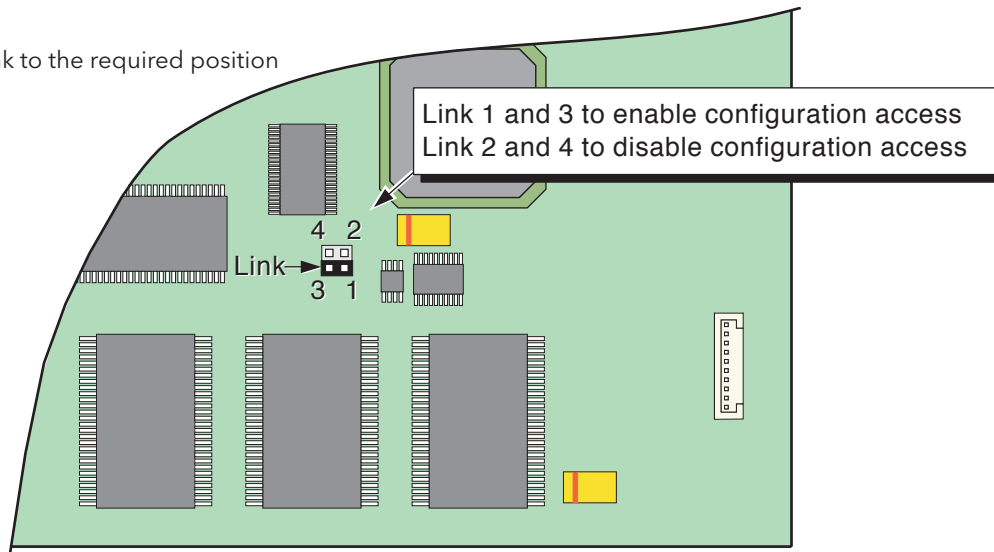

Figure 2.4.2 Enable/disable link location.

2.4.3 Network settings

From the top level menu described above, type <1><Enter> to display the Network Settings menu:

Enter an option number : 1

*** Network Setting Menu ***

1 : View Network Settings
2 : Modify Network Settings
3 : Quit

VIEW NETWORK SETTINGS

Type <1><Enter> to view the current settings. These settings are as described in [Section 4.5 \(Network\)](#) of this manual.

Enter an option number : 1

*** Network Settings ***

MAC address = 08:00:48:80:15:E9
IP address lookup = Obtain from a BootP server
BootP timeout = 20s
IP address = 149.121.130.232
Subnet mask = 255.255.252.0
Default Gateway = 149.121.128.138
Local host =
Domain =

*** Network Setting Menu ***

1 : View Network Settings
2 : Modify Network Settings
3 : Quit

MODIFY NETWORK SETTINGS

Type <2><Enter>, to start the edit sequence. This sequence varies according to the selections made. The following gives one example only. Generally, typing <q><Enter> returns the user to the Network settings menu. Typing <n><Enter>, or just <Enter> calls the next editable parameter. Typing <y><Enter>, produces a list of options from which the user makes the required selection:

Enter an option number : 2

Change IP address from "Obtain from BootP Server" (Y/N/Q?) y

1 : Obtain from a BootP Server
2 : Specify an IP address
3 : Leave unchanged

Enter an option number : 3

Change BootP timeout from "20" (Y/N/Q)?

And so on.

Note: When using the 'Obtain from BootP server' facility, the unit should be 'power cycled' and a note of the allocated IP address made, before attempting to communicate with the unit using Remote Viewer software.

2.4.4 Software upgrade

Software upgrade is to be carried out only by authorized service personnel only.

2.4.5 Lockout Recovery

This procedure should be carried out as a last resort, as using it overwrites all security and access settings previously made by the user. Check in the Security / Access' area (described in [section 4.4.1](#)) that there are no valid 'Engineer' level logins remaining from which recovery can be made.

Enter an option number : 3

*** Lockout Recovery ***

Default product's security settings (Y,N,Q)?

Typing <n><Enter> or <q><Enter> causes a return to the setup menu. Typing <y><Enter> presents a 'Confirm' message:

Confirm default of product's security settings (Y,N,Q)?

Typing <n><Enter> or <q><Enter>, returns to the Setup menu. Typing <y><Enter> causes the default security settings to be applied to the data acquisition unit. This is confirmed by the message:

Security settings defaulted

*** Setup Menu ***

1 : Network Settings
2 : Software upgrade
3 : Lockout Recovery
4 : Start System

Enter an option number : _

2.4.6 Start System

Selecting option 4, restarts the unit, which is now ready for use with Remote Viewer.

3 PROCESS VARIABLE DISPLAY

Process variable values can be displayed in one of a number of formats. This section (3) describes the process variable displays. (Section 4 describes the Configuration displays.) Figure 3, below, depicts a typical trend display and gives details of the various areas of the display page.

Note: Dialogue boxes, message boxes etc. cause Process Variable displays to 'freeze' for as long as the box is on display. Root and Option menus (amongst others) time-out (i.e. are removed from the display) after approximately one minute. Messages, however, are displayed until the operator takes action to remove them. It should be noted, especially, that several message boxes may be active at one time, but only the oldest one is visible, until it is removed to reveal the 'next oldest' message, and so on.

TRUNCATION OF NUMERIC VALUES

If the amount of space on the display page is insufficient to display the full width of the process variable or scale value, then the displayed value is rounded down and the number of decimal places reduced. If the width is still too restricted, the value is displayed in 'scientific' format, or, if it is still too wide, the final visible character of the integer part of the value is replaced by a '?' (as depicted in figure 3.4.3b)

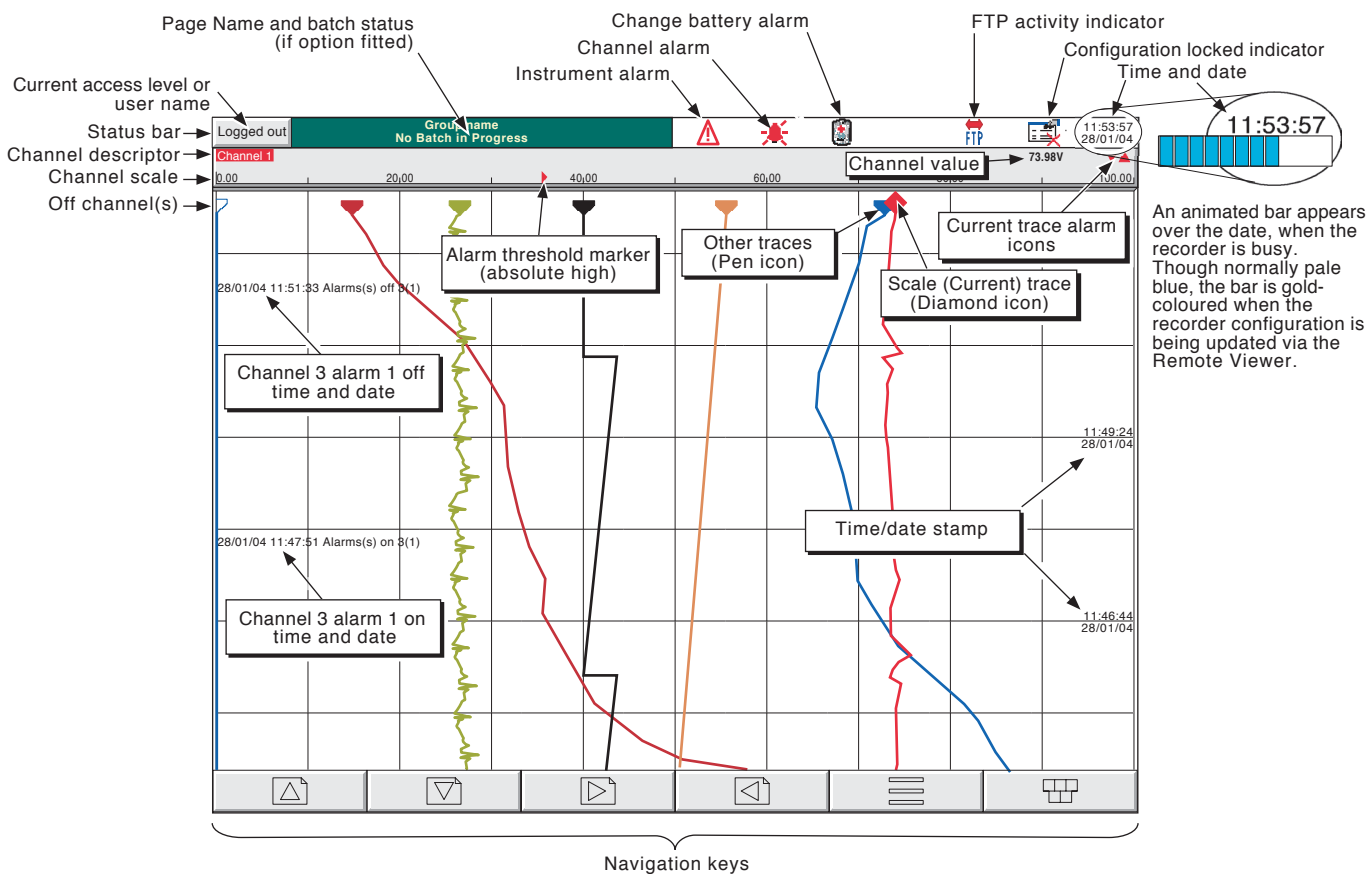

Figure 3 Trend display definitions

3 PROCESS VARIABLE DISPLAY (Cont.)

CURRENT TRACE ALARM ICONS

In each of the different types of PV display, each channel's faceplate gives the status of the channel's alarms. The status of each alarm is shown by one of the icons depicted in table 3, either flashing (if it is active and unacknowledged) or on continuously (if it is active and acknowledged). (See [section 3.1.3](#), below, for a description of how to acknowledge alarms). Absolute alarm threshold icons and deviation alarm bars appear in any display which includes a scale (except circular charts). For deviation alarms, the bar stretches from (Reference - Deviation) to (Reference + Deviation).

Notes:

1. For software versions 2.3 onwards, 32MB versions of the instrument come with four alarms per point, instead of two per point as supplied with previous software versions. The System/About display can be used establish what size of DRAM is fitted - see [section 4.6.5](#).
2. 'Trigger' alarms do not display threshold marks or bars, or faceplate symbols.

| | | |
|---------------|---------------|------------------------|
| 4-alarm units | 2-alarm units | |
| ↓ | ↓ | |
| | | Absolute High |
| | | Absolute Low |
| | | Deviation in |
| | | Deviation out |
| | | Rate-of-change Rising |
| | | Rate-of-change Falling |

Faceplate symbols

| | Absolute low | Absolute high | Deviation In / Out | Rate of change |
|--|--------------|---------------|--------------------|----------------|
| Horizontal scales | | | | No indication |
| Vertical scales | | | | No indication |
| For Deviation alarms, R = Reference; d = deviation | | | | |

Scale symbols

Table 3 Alarm symbols

3.1 STATUS BAR

This appears across the top of the display, and contains the items described below.

3.1.1 Current access level

There are four access levels available (Logged out, Operator, Engineer and Service), and the current level is displayed in this key at the top left hand corner of the display. Clicking this key calls the login page as described in [section 3.3.1 \(Access to configuration\)](#) below. If a user has been added ([section 4.4.3](#), below), then the Full User Name is displayed instead of the access level, when this user is logged in.

3.1.2 Page name

Initially this shows the current group's descriptor. The name changes according to context for example 'Operator' or 'Config-Archive'. If the Batch option is fitted, this area contains batch information as well as the page name. Clicking within this area calls the Batch Status page. See [section 1](#) of the Options Manual for further Batch details.

3.1.3 Alarm indicators

This area of the display can contain the following icons: [Instrument alarm](#), [Channel alarm](#), [Battery change](#). Clicking within this area of the screen calls a pop-up display (figure 3.1.3a) allowing the user to view instrument alarms, to acknowledge all channel alarms, or to display the Alarm Summary page. Entry to Message Log pages ([section 3.2.1](#)) is also possible from this pop-up. For channel alarm symbols refer to '[Current Trace Alarm Icons](#)', above.

ALARM SUMMARY PAGE

As shown in figure 3.1.3a, below, the alarm summary page contains the following information for the current group:

1. Alarm identifier. This appears as a point ID, followed by the relevant alarm number in parentheses. For example, Alarm 1 on maths channel 6 would appear as: D6 (1). Maths channels are prefixed by 'D'. Totalisers are prefixed by 'T' and Counters are prefixed by 'C'. Input channels are not prefixed.
2. Alarm threshold for absolute alarms only
3. The current process value for the point
4. An alarm symbol (see Table 3). Alarm symbols flash until acknowledged.

Notes:

1. Alarms are always listed in Point/Alarm order with input channels first, followed by derived channels, totalisers and counters, if these options are fitted.
2. When the alarm source returns to its non-alarm state: Unlatched alarms are removed from the list whether or not they have been acknowledged; latched alarms remain displayed until acknowledged. See [section 4.3.3](#) for a description of alarm types and actions.
3. There are no time or history components associated with the Alarm Summary. If Alarm messages have been enabled in the relevant group's configuration ([section 4.3.2](#)), then alarm initiation/acknowledgement times and dates can be found from the trend and trend history displays, described in [section 3.4](#), or in message log described in [section 3.2.1](#).
4. If an alarm is active on a channel which is not included in any group, then although the channel alarm symbol will flash, the alarm will not appear in any of the alarm summary pages.

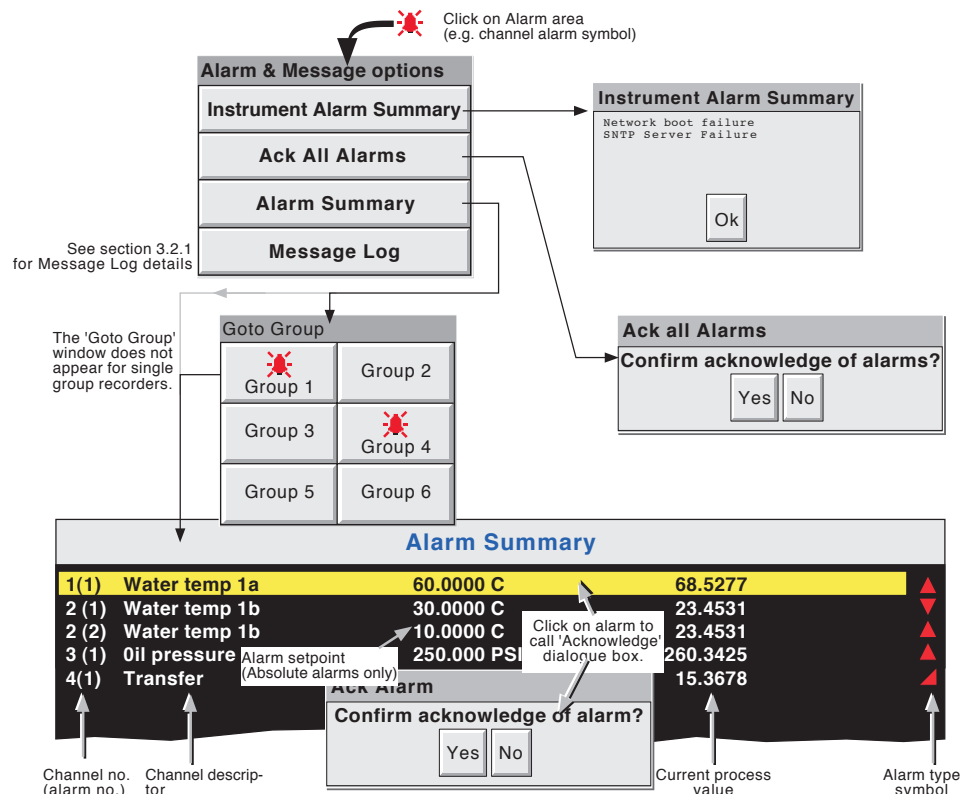

Figure 3.1.3a Alarm and message options display

3.1.3 ALARM INDICATORS (Cont.)

ALARM ACKNOWLEDGEMENT

Alarms can be acknowledged individually, on a group basis, or globally (all alarms).

INDIVIDUAL ALARMS

Individual alarms are acknowledged from the alarm summary page by clicking on the relevant item (highlights yellow), then clicking 'Yes' in the resulting pop-up confirmation box. Figure 3.1.3a, above, attempts to show this process.

GROUP ALARMS

For units with multiple groups, alarms can be acknowledged on a group basis by calling the alarm summary page for the relevant group, then clicking the Options key (section 3.2), the 'Ack Group Alarms' key and finally, 'Yes' in the resulting pop-up confirmation box. Figure 3.1.3b, below, attempts to show this process.

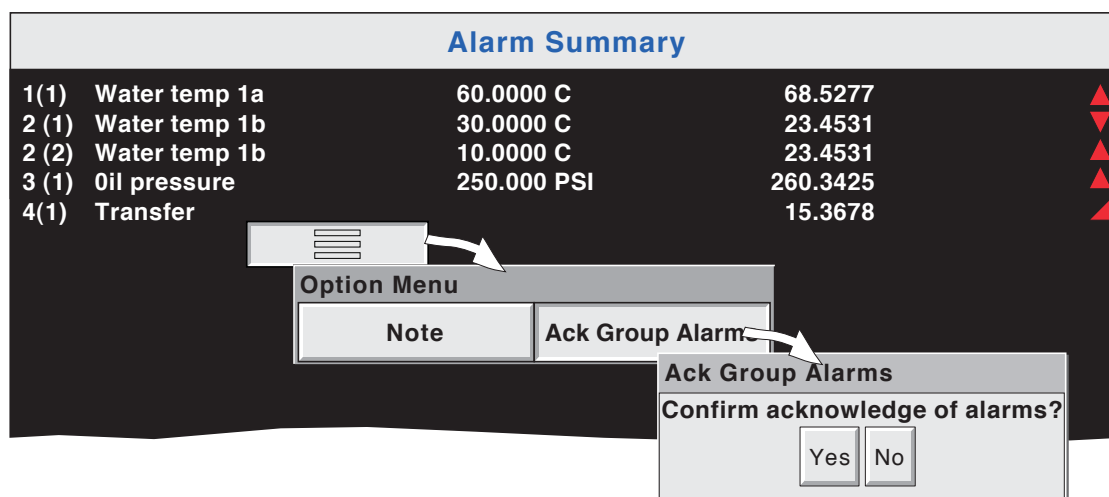

Figure 3.1.3b Group Alarm acknowledgement

ALL ALARMS

To acknowledge all active alarms, click (e.g.) the channel alarm icon at the top of the screen. From the resulting pop-up menu, select 'Ack all Alarms', then finally, click 'Yes' in the resulting pop-up confirmation box. Figure 3.1.3a shows the process.

3.1.3 ALARM INDICATORS (Cont.)

INSTRUMENT ALARM



This indicator appears, flashing, if any of the following are active. The instrument alarm summary page, described above, allows the user to view any such alarms.

| | |
|---|---|
| Archive failed -(message) | Message explains archive failure |
| Battery-backed RAM cleared | This message appears if the battery has failed, and the unit has been switched off. |
| Clock failure | Internal clock was corrupt at power up, or the time has never been set. Can be caused by battery failure, in which case the battery icon will also be visible. The error is cleared by setting the time and date. Server time forced to 00:00 1/1/1900. |
| Channel failure | Indicates a hardware failure in the input channel circuit |
| Channel error | Indicates a hardware failure in the channel circuit or in the internal CJ temperature measurement |
| FTP Primary Server Failure | This error is set if the unit fails, after two attempts, to establish communications with the primary server as defined in Archive Configuration (section 4.3.5). After the second attempt has failed, the Secondary server is tried. |
| FTP Secondary Server Failure | This error is set if the unit fails, after two attempts, to establish communications with the secondary server as defined in Archive Configuration (section 4.3.5). See also 'FTP Primary Server Failure, above. |
| Insufficient non-volatile memory... | There is insufficient memory available for the configuration. Can sometimes be caused by use of Rolling Average Maths functions. |
| Internal flash: \user\ required repair | Error found (in the internal file system) at power-up, and corrected. |
| Internal flash: \user\ is full | Appears if the User partition is full. To clear, either user screens must be simplified or files must be deleted from \User\, or both. |
| Internal flash: \system\ required repair | Error found (in the internal file system) at power-up, and corrected. |
| Internal flash: \history\ required repair | Error found (in the internal file system) at power-up, and corrected. |
| Maths Channel failure | Appears if, for example, the divisor of a divide function is zero. |
| Paper Low/Paper Out | Warning messages from the ASCII printer (if fitted) |
| Printer not Responding | There is a fault in the serial comms link with the ASCII printer (if fitted). |
| Recording failed - (message) | Message explains recording failure - due to file error, internal overflow etc. |
| SNTP server failure | This error is set if:- a) the year received from the server is < 2001 or > 2035 or b) the configured SNTP server cannot be accessed |
| Time synchronisation failure | Set if 5 or more 'Time change events' are caused by the SNTP server within 24 hrs. A 'Time change event' is defined as occurring whenever the unit time is found to be more than 2 seconds different from the server time. The alarm does not appear until 24 hours have elapsed since the first of the five or more Time Change events occurred. |

CHANNEL ALARM



This red 'bell' indicator appears if any channel is in alarm. The symbol is illuminated continuously if all alarms are acknowledged or flashes if any active alarm is unacknowledged. Refer to '[ALARM ACKNOWLEDGEMENT](#)' above, for details of how to acknowledge alarms.

CHANGE BATTERY



This flashing indicator first appears when the battery voltage indicates that the battery is approaching the end of its useful life. The indicator continues to flash until the battery is replaced ([Annex B - B1.2](#)). The indicator does not appear if the battery is not fitted.

3.1.3 ALARM INDICATORS (Cont.)

3.1.4 FTP Icon

The FTP icon appears to the right of the disc icon position whenever transfer activity is taking place.

3.1.5 Configuration Locked indicator

This symbol appears whilst the unit is 'synchronising' configuration changes

3.2 NAVIGATION KEYS

Above the lower edge of the window are six keys (figure 3.2 below) which allow the user to perform various context-related tasks such as to change the display mode (section 3.4), to access configuration, to archive data, to select groups etc. In addition to this, left and right arrow keys or open/close folder keys appear when relevant.

Note: The overall size and aspect ratio of the bottom-of-window keys are determined by the size and shape of the screen window being used, and will therefore often be different from those shown in figure 3.2.

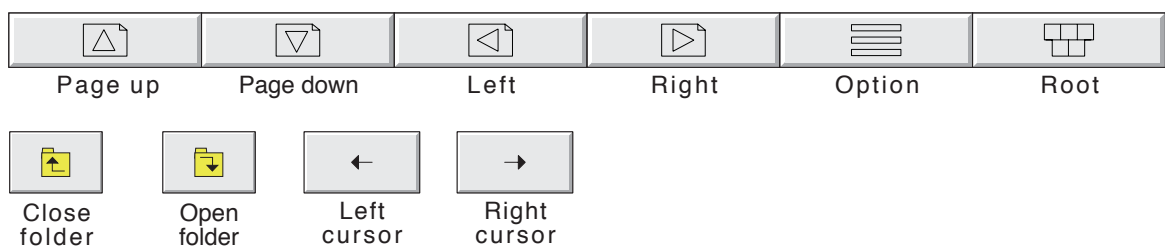

Figure 3.2 Navigation keys

3.2.1 Key functions

| | |
|-------------|---|
| Page up | Used, as appropriate, to recall the previous (higher level) display page, to call the previous display mode and to scroll through previous text entries. Where relevant, the function of this key is mimicked by the 'Close folder' key. |
| Page down | Used, where appropriate, to call a further (lower level) display page, to call the next display mode and to scroll through previous text entries. Where relevant, the function of this key is mimicked by the 'Open folder' key. |
| Left arrow | Used a) if multiple groups are fitted, to select previous group, or b) to navigate backwards through a text string, when editing. Where relevant, the function of this key is mimicked by the 'Left cursor' key. |
| Right arrow | Used a) if multiple groups are fitted, to select next group, or b) to navigate forwards through a text string, when editing. Where relevant, the function of this key is mimicked by the Right Cursor' key. |
| Option | Calls a pop-up Options menu allowing the user to carry out functions such as Entering/quitting history, turning channel cycling on and off etc. according to context. 'Refresh', redraws the trend display. |
| Root | Calls the 'Root Menu' as shown in figure 3.2.1a, below. To quit the Root menu, click the root key again. |

3.2.1 KEY FUNCTIONS (Cont.)

ROOT MENU KEYS

- Home Causes a return to the 'Home' page from other page. As delivered, the 'Home' page is the Group 1, vertical trend display as depicted in [figure 3](#), above, but this can be edited (in [Config/Views](#)) to be any of the other available groups' display modes - Horizontal trend, Vertical bargraph, Horizontal bargraph, Numeric etc.
- Operator Causes the top level Operator page to appear. The appearance of this display is dictated by the security level that the unit is set to, and by the access level of the user. As despatched from the factory, the unit is in 'logged out' mode and the Operator page contains only 'Archive', 'Security' and 'System'. Further details appear in '[Access to configuration](#)' below.
- About Clicking on this key calls the 'About' screen, which, as described in [section 4.6.5](#), displays details of the instrument's hardware and software version levels.
- Goto View Allows the user to select the display mode for the current group, as shown in figure 3.2.1a. Display modes not enabled for this group in [Config/Views](#) configuration pages (section 4.3.4) do not appear. As an alternative, display modes can be scrolled-through using the up and down arrow navigation keys.
Goto view also offers an alternative means of entry to the Alarm Summary page described in section 3.1.3, and also allows entry to the current group's Message Log pages, described below.
- Goto Group Allows a group to be selected for display. Groups which are not 'display enabled' in the Config/Views page are greyed. An alarm icon appears (as shown for groups 1 and 4, in figure 3.2.1b, below) for any group containing one or more points in alarm. The icon flashes if any of the group's alarms have not been acknowledged. If multiple groups are not fitted, the 'Goto Group' sub-menu does not appear.

Note: For multiple groups only, the right arrow key at the bottom of the window can be used to scroll through groups in ascending group number order. The adjacent left arrow key can be used to scroll through groups in descending group number order.

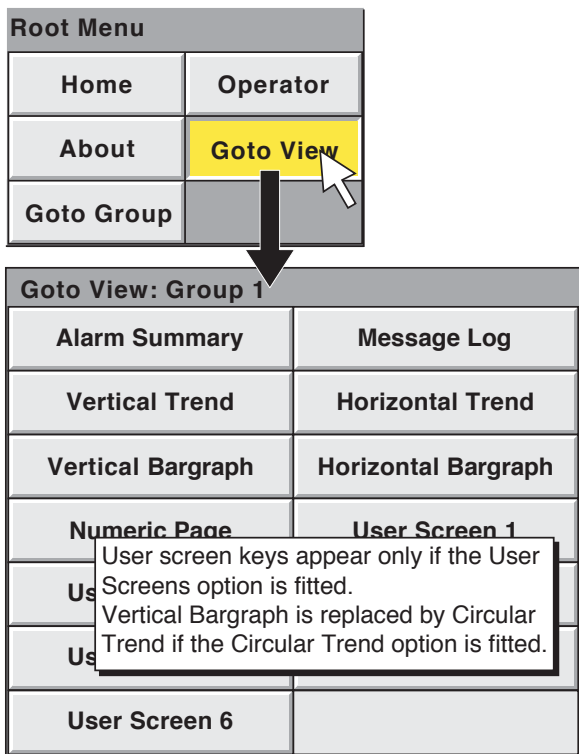

Figure 3.2.1a

Root menu with Goto view sub menu

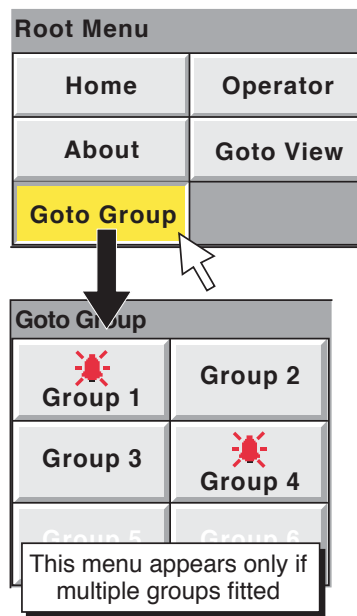

Figure 3.2.1b

Root menu with Goto Group sub menu

3.2.1 KEY FUNCTIONS (Cont.)

MESSAGE LOG

The Root menu/Goto View/Message log key calls the first Message Log page for the current group to the screen, as shown in figure 3.2.1c, below. Alternatively, Message Log can be selected from the Alarm & Message options menu, (section 3.1.3) and in this case, the user selects a 'Group' for the Message Log display from a pop-up (Goto Group) menu.

If there are more messages than can be displayed in the height of the screen, a scroll bar appears to allow 'hidden' messages to be displayed.

Messages are retrieved from the history files in batches of 100 messages. If there are more than 100 messages, 'Earlier messages..' appears after the hundredth message. Clicking on 'Earlier messages..' calls the option menu, and operating 'Earlier messages..' in this menu, calls the next batch of 100, and so on. If applicable, clicking on 'Later messages..' / 'Later messages..' calls the previously displayed 100 messages.

As can be seen from the figure, the list of messages can be 'filtered' both by type and by time. For example, setting the message type to 'Alarm' and the period filter to 'Last Day' excludes all messages except alarm messages which have occurred within the previous 24 hours.

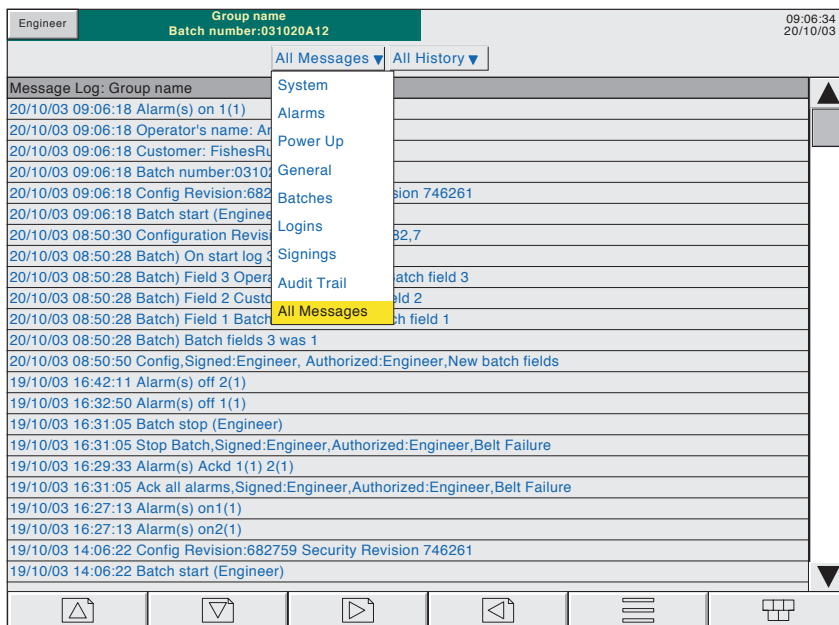

Figure 3.2.1c Message log page showing message-type picklist

MESSAGE TYPE FILTER

- All Messages All messages are displayed
- System Lists only system messages and instrument alarms.
- Alarms Only alarm on/off and acknowledgement messages appear.
- Power Up Displays power up messages only. If the Auditor Pack option is enabled, then Config Revision and Security Revision are included. See sections 4.4 and 4.6.5 for more details.
- General Displays messages sent via Modbus, operator notes/custom messages etc. if they do not have to be 'signed' (Auditor Pack option only - see section 4.4 for more details). If the notes etc. are signed, they appear in the 'Signings' message type list. If the e-mail option is fitted, a message is generated each time an e-mail is sent. See section 11 of the Options Manual for details of the e-mail option.
- Batches Displays only batch messages (including Config and Security Revisions if the Auditor Pack option is fitted).
- Logins Lists only changes in login.
- Signings This list contains only notes, messages etc. that have been signed/authorized. This category is used only when the Auditor Pack option is fitted - see section 4.4 for more details.
- Audit trail This list contains Configuration change messages only. This category is used only when the Auditor Pack option is fitted - see section 4.4 for more details.

3.2.1 KEY FUNCTIONS (Cont.)

PERIOD FILTER

This picklist allows the user to select one of the following to define the period of time that the message list is to encompass:

All History, Last Month (28 days), Last Week, Last 3 Days, Last Day or Last Hour,

OPTION MENU

Clicking on a message (highlights yellow) calls the Option Menu* as shown in figure 3.2.1d, below.

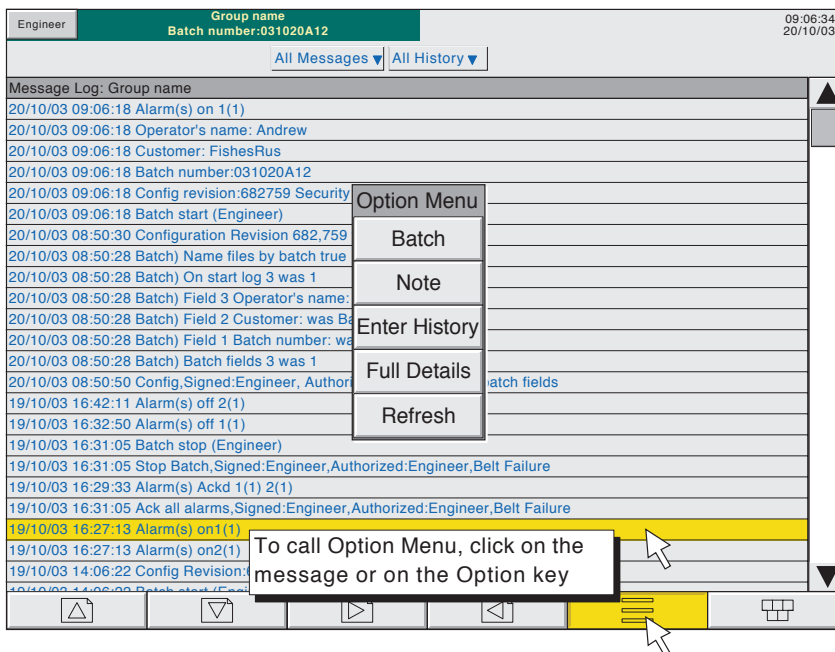

Figure 3.2.1d Message Log options menu

- Batch See Section 1 of the Options Manual
- Note See section 3.5 of this manual
- Enter history Clicking on the Enter History key causes the instrument to display that page of history which includes the highlighted message. See section 3.4.1 for details of trend history. When in Trend history mode, clicking on the Message Log key calls that message log page which contains those messages which are nearest the trend history cursor time.
- Full details If the highlighted message is wider than the display, the whole message can be displayed by operating the 'Full Details' key.
- Refresh/Earlier messages../Later messages.. 'Refresh' places (at the top of the screen), any messages, which have occurred since the Message Log page was last entered, or since the last 'Refresh'. If earlier or later messages have been selected, then 'Refresh' is replaced by 'Earlier messages..' or 'Later messages..' as appropriate, and clicking the key calls the next or previously displayed group of 100 messages to the display respectively.

- * The option menu can also be called by clicking on the option key. In this case:
- a. Enter History calls the current Trend History display, as described in section 3.4.1, and
 - b. Because no message is highlighted, the 'Full Details' key is not enabled,

Notes:

- 1 Selecting 'Enter History' whilst either 'Earlier Messages' or 'Later Messages' is highlighted calls the current History page.
- 2 If the Option Menu has 'timed out' leaving a message highlighted, and the option key is operated, then this is equivalent to reselecting the message.

3.3 FIRST SWITCH-ON

When the Remote Viewer and the Data Acquisition unit first run together, the group 1 vertical trend page is displayed. It is unlikely that this will contain any useful information because the input channels will not, as yet, have been configured to suit the type of input signals being applied to them, as described in [section 4](#).

Notes:

- 1 There is no on/off switch associated with the instrument
 - 2 Date, time and the message 'Power Up' are printed on the 'chart' each time power is applied to the unit, followed by a similar message giving 'Config Revision' and 'Security Revision'.
 - 3 A red line is drawn across the width of the chart at power-up.
-

There are four security levels as follows

| | |
|------------|--|
| Logged out | Initially, no access to configuration pages is possible. Only Archive, Login/security and the System 'About' functions can be accessed - via the root menu. Limited or full access can be permitted from 'Engineer' level. |
| Operator* | No access to configuration pages is possible until access permissions have been set up. Section 4.4.1 describes how limited or full access can be permitted by an operator with 'Engineer' level access. |
| Engineer* | Accessed initially, by entering '10' as the password (section 3.3.1, below). Full access to all configurable functions is available. Section 4.4.1 describes how the Engineer level password can be edited and an Operator password can be entered if required. The section also describes how access permission to some or all of the instrument functions can be granted, or not, to individual user names and default security levels (except 'Service'). |
| Service | Full access to all instrument functions and to areas of memory for diagnostic purposes. For use only by Service Engineers. |

*Note: For units fitted with software versions 3.1 onwards, AND which have the Auditor Pack Option enabled, the default Engineer and Operator passwords are both '100'.

3.3.1 Access to Configuration

- 1 As shown in figure 3.3.1a, once the unit has initialised, click the current access level key
- 2 Click on the 'Logged out' field and then select 'Engineer' from the resulting picklist.
- 3 Click the blank Password area and enter the value '10' from the PC keyboard (see Note 1 below)
- 4 The screen reverts to the 'Home' page.
- 5 A click on the [Root](#) key followed by a click on the Operator key calls the top level page allowing access to the [Archive](#), [Save/Restore](#), [Config](#), [Security](#), [Network](#) and [System](#) areas described in [section 4](#) below.

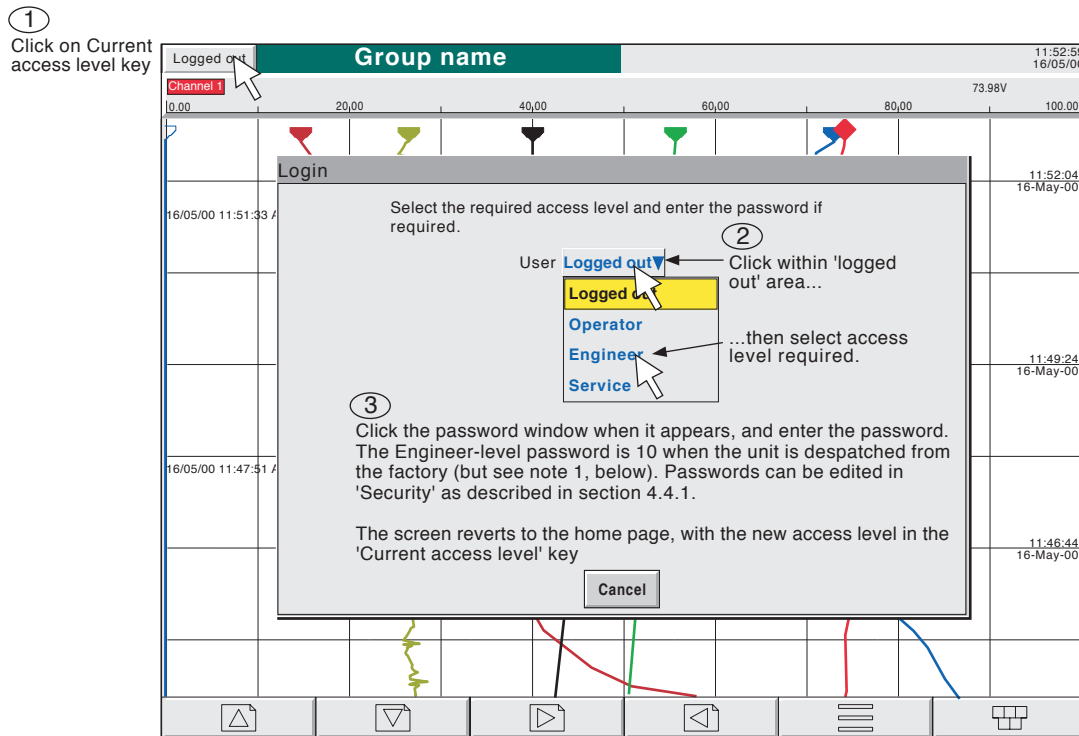

Figure 3.3.1a Access to configuration

Notes:

1. For units fitted with software versions 3.1 onwards, AND which have the Auditor Pack Option enabled, the default Engineer and Operator passwords are both '100'.
2. Figure 3.3.1a shows 'Login by User List', which is the default method. If the Auditor Pack and/or Security Management option is fitted, an alternative 'Login by User ID' procedure is possible. See [section 4.4.2 \(Management\)](#) for details.

3.3.1 ACCESS TO CONFIGURATION (Cont.)

TEXT STRING ENTRY

When any text string entry is required (e.g. channel descriptor), double clicking† on the existing text field calls the first of a number of keyboards. Figures 3.3.1b and 3.3.1c below are an attempt, within the limitations of the illustrating process, to depict these keyboards. Actual entry of the text string is either by clicking on the relevant key, or by using the computer keyboard. For items which require only a numeric entry (e.g. channel range) the numeric keyboard appears.

When editing existing text strings, the existing text string appears highlighted, and will be replaced in its entirety by the first character entered. To avoid this, the left arrow key* can be clicked to 'unhighlight' it. The down and up arrow keys can be used to scroll through previously entered text strings.

†Note: Text entry from the computer keyboard is possible having highlighted the existing text field by clicking on it only once. Text entry in his case is 'Insert' rather than 'Overwrite', so the existing string may have be deleted in its entirety before editing.

Immediately below the keyboard are six keys with the functions listed below. When active, the background colour changes to yellow for as long as the key is active.

- Shift* Once the shift key has been clicked-on, the next-entered letter appears as a capital; subsequent letters are in lower case.
- Caps* When clicked-on, all subsequent letters appear as capital letters until the Caps key is clicked again
- BSpC This backspace key deletes character to the left of the cursor..
- Ovr If selected, the next-entered character replaces (overwrites) the existing character to the right of the cursor position. If not selected, the next-entered character in inserted into the existing text string at the cursor position.
- Ok Used to save the new text string and to return to the page from which the keyboard was called.
- Cancel Causes a return to the page from which the keyboard was called without saving the new string.

***Notes**

1. The character on each display key is always a capital letter, whether or not the actual character being entered is in capitals or lower case.
2. The cursor keys mimic the function of the left and right arrow keys at the bottom of the screen.

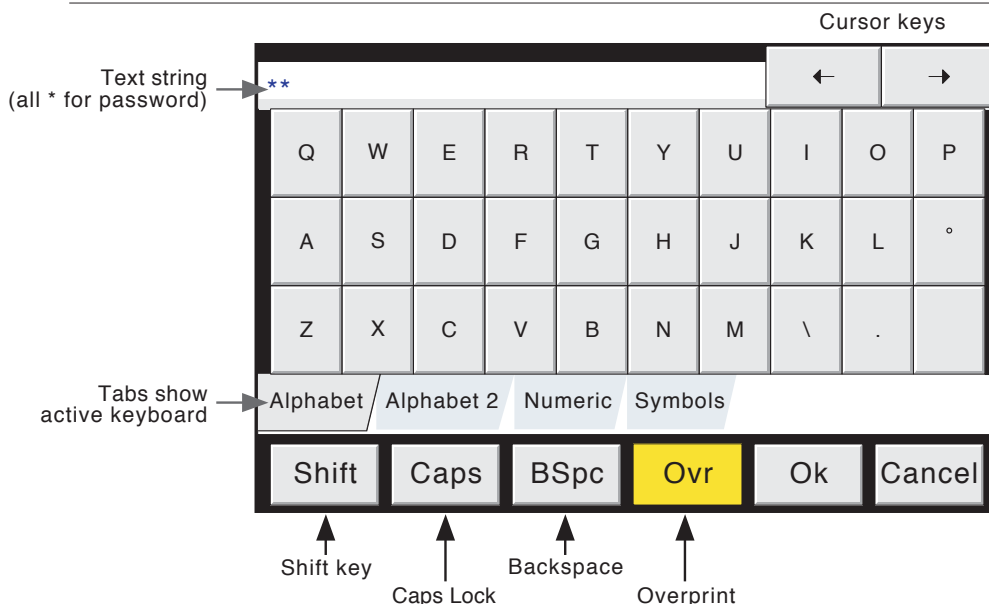
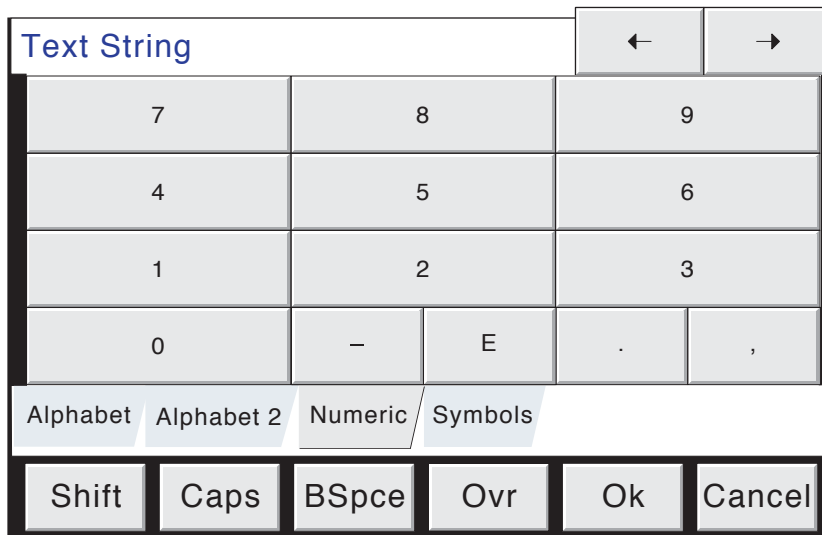
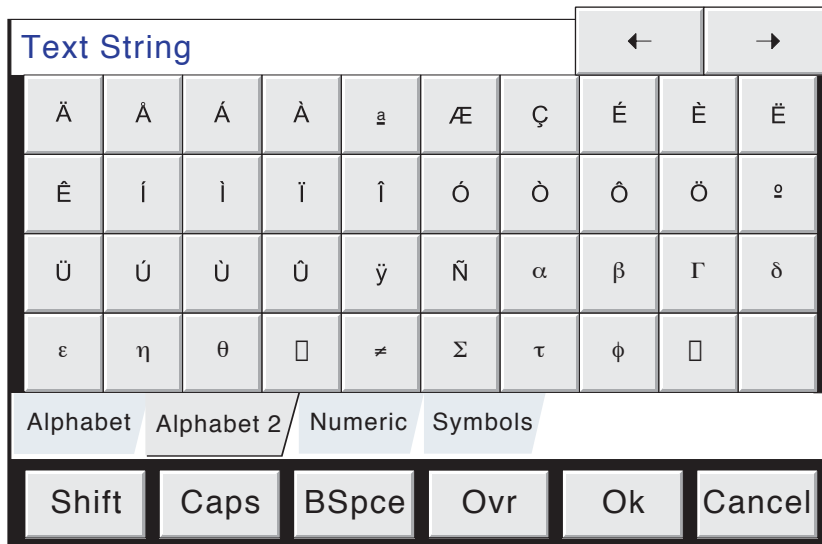

Figure 3.3.1b Alphabet 1 keyboard

3.3.1 ACCESS TO CONFIGURATION (Cont.)

TEXT STRING ENTRY (Cont.)



The 'E' key is used to enter exponents

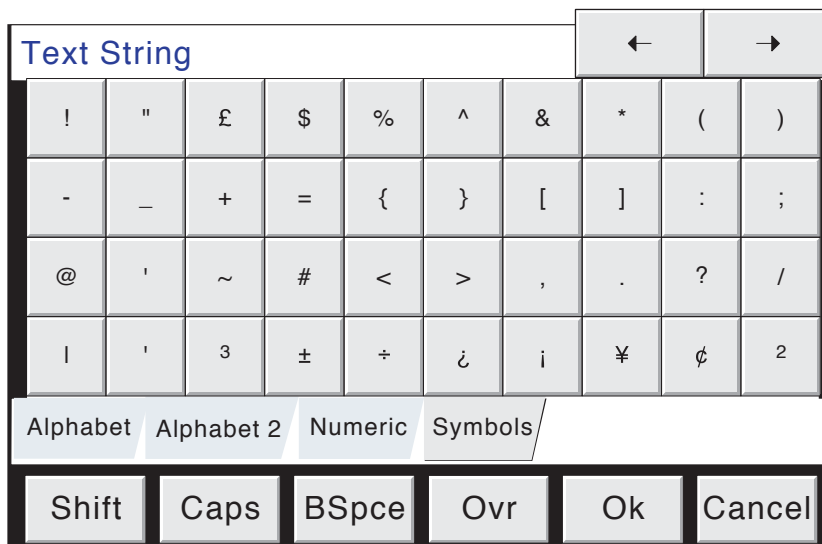

Figure 3.3.1c Alternative keyboards

3.4 DISPLAY MODES

The display modes described below allow the currently displayed group's process values (channels, totalisers etc.- known collectively as points) to be displayed as vertical or horizontal 'chart' traces, as vertical or horizontal bargraphs or as a numeric value. If the Circular Trend option is fitted, the points can alternatively be displayed as traces on a circular 'chart'. If fitted, Circular Trend display replaces Vertical Bargraph display mode. The various display modes are cycled-through using the up/down arrow keys, or a specific mode (or view) can be selected from the [Root Menu](#) 'Goto View' key. If Multiple Groups are fitted, then groups can be scrolled using the left/right arrow keys. The [Home](#) key returns the user to the Home page (defined in [Configuration/Views - section 4.3.4](#)) from anywhere in the Operator or Configuration pages. When dispatched, the Home page is Group 1, vertical trend display. See also the User Screens description at Section 2 of the Options Manual.

3.4.1 Vertical Trend display

This (default) display ([figure 3.4.1b](#)) shows each point in the display group as though it were being traced on a white chart. It is possible to display on a black 'chart' instead, by selecting Dark Trend Background in [Configuration - Views](#). In either case, some thought should be given to trace colours selected in channel configuration. When selected, dark background applies both to vertical and horizontal trend display modes for all Groups.

One of the channels is said to be the 'current' or 'scale' channel. This channel is identified by its diamond shaped pen icon and by its descriptor, digital value and scale being displayed on a 'faceplate' across the full width of the screen, above the chart. Faceplates for all the group channels can be displayed, by using the Faceplates On/Off key in the option menu. If selected On, faceplates (showing colour, descriptor, digital value and units) for all the group's channels appear either above the current channel's faceplate or, if there are too many to fit across the screen, at the right hand edge of the screen. When necessary, a slider bar appears to allow further (hidden) faceplates to be viewed.

Each channel in the display group becomes the 'current' channel, in turn, for approximately 10 seconds - i.e. the channels are cycled-through, starting with the lowest numbered channel. Once the final channel in the group has been displayed for 10 seconds, the lowest numbered channel is returned to and the sequence repeats. This scrolling process can be stopped using the Channel Cycling key in the Option menu.

To select a particular channel to be the current channel, the relevant pen icon can be clicked-on. To cycle through the channels manually, the faceplate area is clicked repeatedly until the required channel is reached.

If a channel is included in the display group but its status is 'not good' for some reason, then its pen icon is hollow.

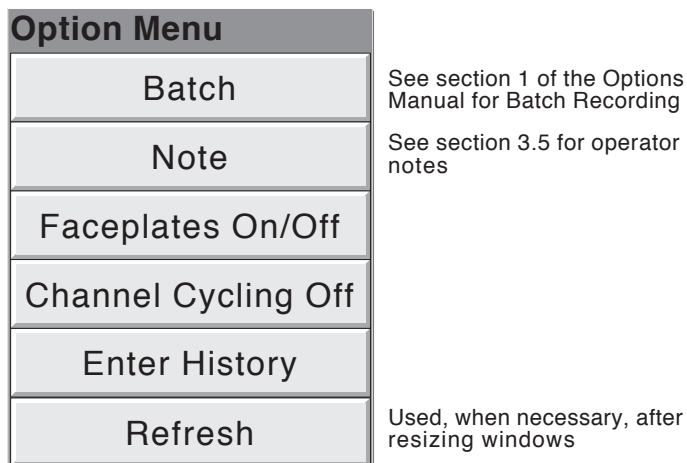

Figure 3.4.1a Option Key Menu (Typical)

VERTICAL TREND DISPLAY (Cont.)

TIME CHANGE RECORDS

For vertical trend mode only, a line is drawn across the width of the chart whenever a time discontinuity in the record occurs. These lines are volatile in real-time i.e. they disappear if the display mode is changed, or if a configuration page is called etc.

| | |
|------------|---|
| Red line | A red line is drawn on the trend history chart at power up. |
| Blue line | A blue line indicates that recording has been disabled/enabled in Group Configuration (section 4.3.2), or by a recording job (section 4.7.10). |
| Green line | A green line appears if there has been a time change as a result of a clock job (section 4.7.6), an SNTP synchronisation or by the operator physically changing the time setting. |

Note: Changes from standard time to daylight saving time and back again are not 'green lined' in this way

TREND HISTORY

Trend history, allows the user to view the history of the display group. The maximum amount that can be reviewed depends on a number of factors, including how many points are configured, how rapidly the traces are changing and so on. At a recording rate of 20mm/hour (see [group configuration - section 4.3.2](#)), with all channels configured, a minimum of 30 day's worth of traces is available for viewing, provided that the group contents are not re-configured during this period (in which case, the history starts at the end of the re-configuration). The amount of trace visible on the screen depends on the recording rate, the higher the rate, the less trace is visible at any one time.

Notes:

1. Trend history mode is not available for groups with 'Recording Enable' disabled ([Group configuration - section 4.3.2](#)).
 2. Channel cycling is inhibited in trend history mode. To increment the current channel, touch the faceplate.
 3. Group faceplates are not displayed in trend history mode.
 4. With A/B switching selected, traces are displayed with the 'A' or 'B' span/zone, colour settings etc. obtaining at the cursor time. See [sections 4.3.2, 4.3.3 and 4.7](#), for more details of A/B switching.
-

To enter trend history mode, the option key can be used (as shown in figure 3.4.1b), or the trace area of the screen can be clicked and held clicked until the screen blanks prior to re-drawing. A 'Preparing History, please wait' message appears whilst the re-drawing calculation is taking place. Although tracing stops whilst trace history mode is active, no data is lost. Process Variable values are saved in the instrument's memory. Alarms are still scanned-for and any associated action taken.

The trend history display is similar to the real-time trend display, with the addition of a slider control and up and down keys for selecting that part of trend history which is to be displayed. The controls are used as follows:

- 1 Clicking the up or down key once, causes the trace history to move an incremental amount.
- 2 Clicking and holding clicked the up or down key, causes continuous movement.
- 3 Clicking on the bar above or below the slider causes a page-height shift. The Page up and Page down keys can also be used to provide this function.
- 4 Click-dragging the slider, whilst observing the time/date display, allows the user to select the section of history exactly.

On first entry to trend history mode, the channel value and the time and date shown in the faceplate are those at the top edge of the chart. Clicking on the screen causes a cursor line to appear at the arrow point. This cursor line can be click-dragged up and down the screen to provide a reference point on the current trace. The displayed value date and time refer to the cursor intersection with the current channel. To return to real-time trending, the Option key is operated, followed by 'Exit History'.

When back in real-time trending, the Horizontal Trend display can be called using the down arrow key. Alternatively, any one of the enabled display modes ([section 4.3.4](#)) can be selected using the [Root Menu](#), 'Goto View' key.

VERTICAL TREND DISPLAY (Cont.)

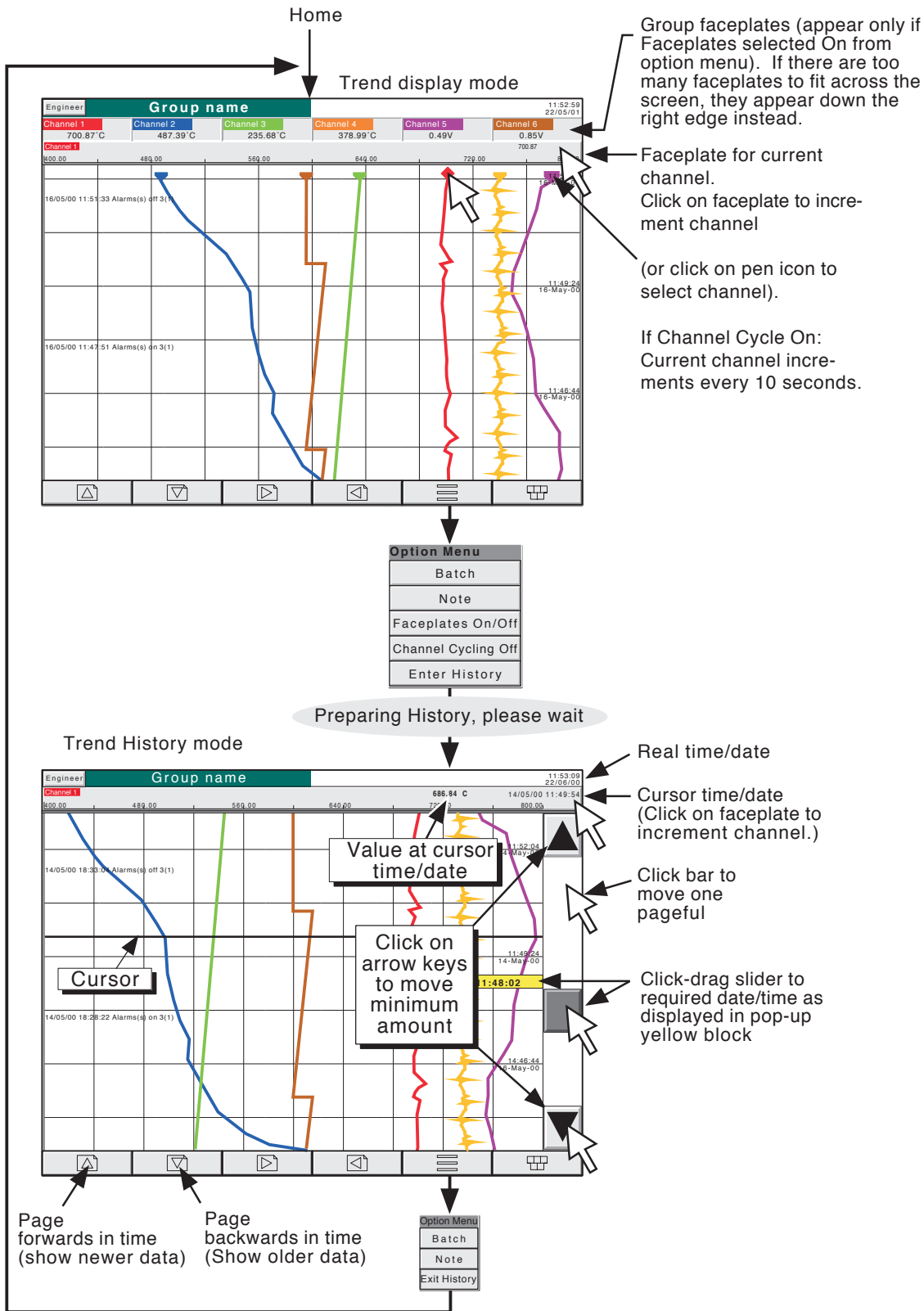

Figure 3.4.1b Trend display mode and trend history mode

3.4 DISPLAY MODES (Cont.)

3.4.2 Horizontal Trend display

Entered from the Vertical Trend display by means of the down arrow key, or selected via the [Root Menu](#) 'Goto View' key, this display mode (figure 3.4.2a) is similar to the Vertical Trend display described in section 3.4.1 above, except that the traces are produced horizontally rather than vertically.

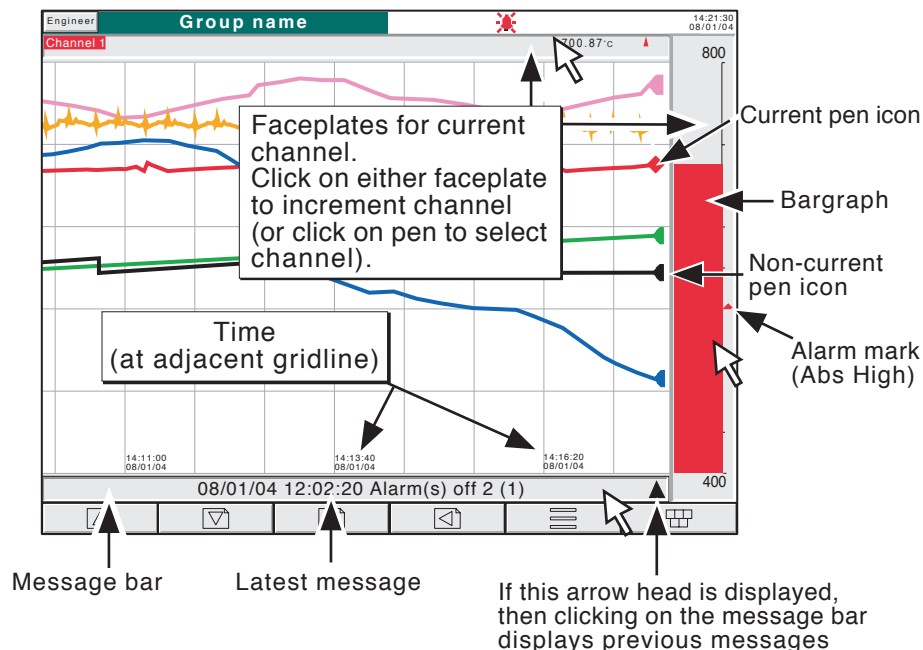

Figure 3.4.2a Horizontal Trend Display

One of the channels is defined as being the 'current' or 'scale' channel and this is identified on the chart by its pen icon being diamond shaped rather than triangular as for non-current channels. If a channel is included in the display group, but its status is 'not good' for some reason, then its pen icon is hollow. Each channel in the display group becomes the 'current' channel, in turn, for approximately 10 seconds - i.e. the channels are cycled-through, starting with the lowest numbered channel. Once the final channel in the group has been displayed for 10 seconds, the lowest numbered channel is returned-to and the sequence repeats. This scrolling process can be stopped using the Channel Cycling On/Off key in the Option menu.

There are two faceplates associated with this display mode, one above the 'chart', showing the current channel's descriptor and its digital value; the other - to the right of the 'chart' - showing a bargraph representation of the current channel's value, together with a scale showing the low and high range values for the channel. Clicking on either of these faceplates* causes the current channel number to increment. To select a particular channel to be the current channel, the relevant pen icon can be clicked-on. In either case, the bargraph and the background colour of the channel descriptor take the colour of the new current channel.

There is no horizontal trend history function. Clicking and holding clicked the trace for a few seconds, or using the Option key then 'Enter History' calls the Vertical trend history page described in section 3.4.1, above.

Time and date are printed on the 'chart' immediately to the right of grid lines, and it is to these grid lines that the printed time and date relate.

*Note For zoned channels, the bargraph must be clicked-on within the scale area.

3.4.2 HORIZONTAL TREND MODE (Cont.)

Below the 'chart' is a message bar, containing the latest message to become active. If there is more than one message, an arrow head icon appears near the right-hand end of the message bar. If this arrow head appears, then clicking-on the message bar calls a pop-up box (figure 3.4.2b) which displays the latest messages. If there are more messages than can be displayed in the box, a slider control appears, which can be used to access previous messages, up to a total of 60 messages. Further messages, cause the oldest messages to be discarded to keep the total to 60.

Note: At power-up, only those messages which have occurred within the 'time-width' of the page are displayed.

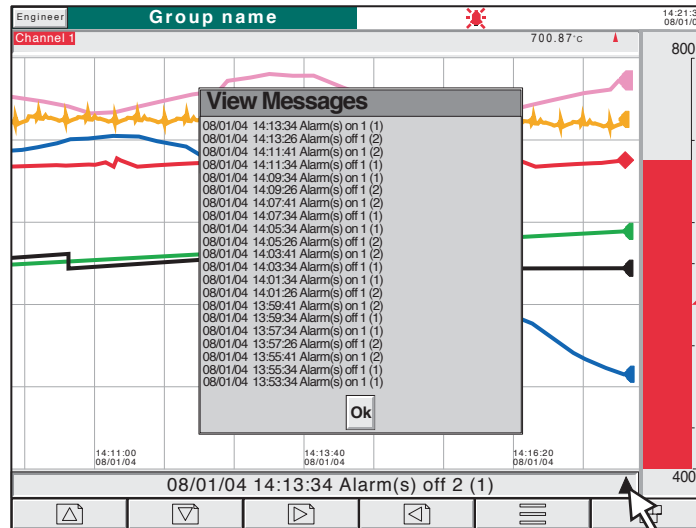

Figure 3.4.2b Horizontal Trend mode message dialogue box

The vertical bargraph display mode (or Circular Trend mode, if the option is fitted) can be called by using the down arrow key. Alternatively, any one of the enabled display modes (section 4.3.4) can be selected using the **Root Menu**, 'Goto View' key.

3.4 DISPLAY MODES (Cont.)

3.4.3 Vertical bargraph

Note: If the Circular Trend option is fitted (section 3.4.6), the Circular Trend display mode replaces the Vertical Bargraph mode. In such a case, Vertical Bargraph does not appear in the Views configuration menu, in the GoTo View menu or in the down arrow scroll list, but is available to User screens if the relevant option is fitted. See section 2 of the Options Manual for a description of the User Screens option.

Entered from Horizontal Trend mode by means of the down arrow key, or selected from the [Root Menu](#) 'Goto View' key, this display mode shows the Process Variable (PV) values as vertical bars with faceplates containing digital values and alarm data. There are two versions, one with faceplates above the bars (1 to 6 channels - figure 3.4.3a); the other (with faceplates at the right hand edge of the display - figure 3.4.3b) is used where there are more than six channels (note 1).

Operation of the option key calls the Option menu display for this display page, allowing faceplates to be selected on or off. This feature is available for vertical trend and vertical bargraph displays only.

To call the horizontal bargraph display mode, use the down arrow key. Alternatively, any one of the enabled display modes (section 4.3.4) can be selected using the [Root Menu](#), 'Goto View' key.

Trend history mode is not available from this display mode.

FACEPLATES ABOVE THE BARS

See figure 3.4.3a.

As the number of channels in the display group increases, the bars and their faceplates get narrower,

FACEPLATES AT RIGHT-HAND EDGE

As the number of PVs increases, the bars get narrower. As the bars get narrower, so the scale values become truncated as shown in figure 3.4.3b. The bars have a set minimum width, and if the total number of points in the group cannot be displayed within the width of the screen, a horizontal scroll bar appears, allowing 'hidden' bars to be viewed. Similarly, the faceplates reduce in height to a minimum readable height. If there are more point faceplates than can be accommodated within the height of the screen, a vertical scroll bar appears, allowing hidden faceplates to be displayed as required.

Note: Faceplates appear above the bars for one to six points, and to the right of the bars for more than six points (where 'points' means input channels, totalisers, counters, maths channels etc.).

3.4.3 VERTICAL BARGRAPH (Cont.)

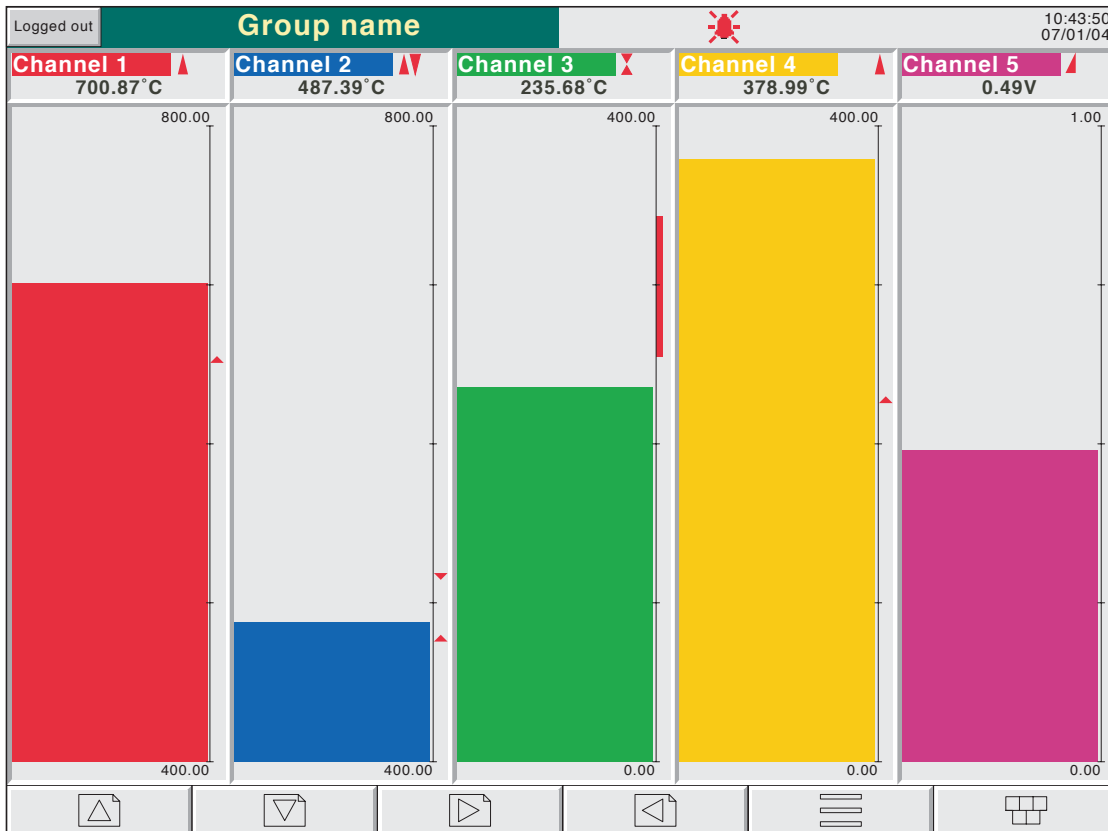

Figure 3.4.3a Vertical bargraph display (1 to 6 points)

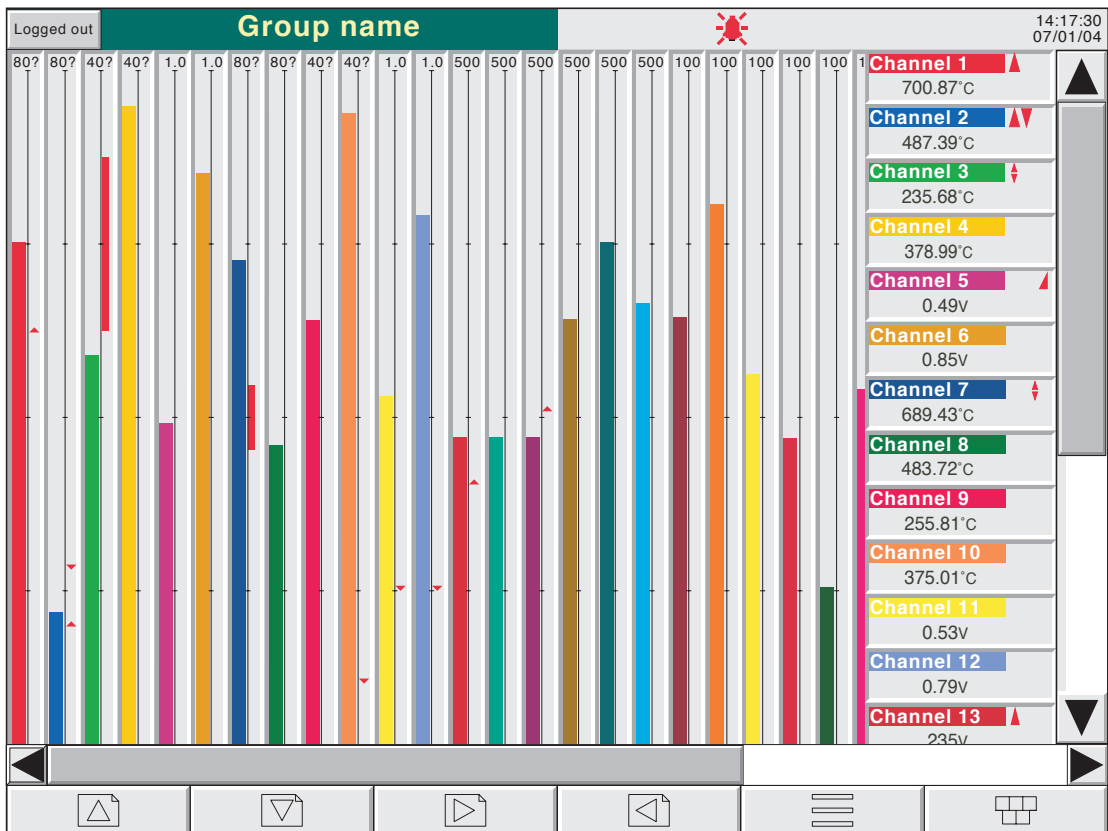

Figure 3.4.3b Vertical bargraph display (more than 6 points)

3.4 DISPLAY MODES (Cont.)

3.4.4 Horizontal bargraph

Entered from Vertical bargraph mode or (if fitted), the Circular trend mode, by means of the down arrow key, or selected using the [Root Menu](#) 'Goto View' key, this display mode shows the Process Variable (PV) values as horizontal bars with digital values and alarm data displayed, as shown in figures 3.4.4a and 3.4.4b. Single column format is used when there are up to 12 points in the display group; double column for more than 12 points (where 'points' means input channels, totalisers, counters, maths channels etc.).

Trend history mode is not available from this display mode.

To call numeric display mode, use the down arrow key. Alternatively, any one of the enabled display modes ([section 4.3.4](#)) can be selected using the [Root Menu](#), 'Goto View' key.

Note: No more than 26 points can be displayed on one page. If more than 26 points are configured, a vertical scroll bar appears allowing currently hidden points to be displayed.

3.4.4 HORIZONTAL BARGRAPH (Cont.)

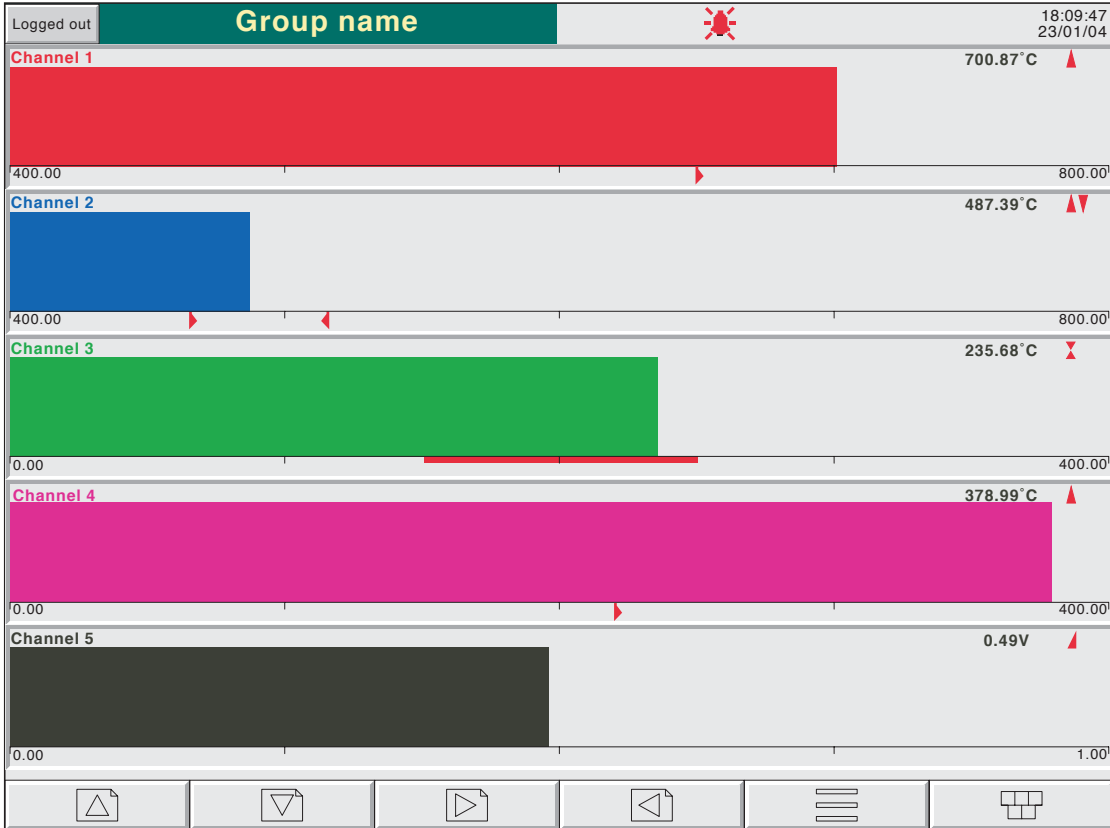

Figure 3.4.4a Horizontal bargraph display (1 to 12 points)

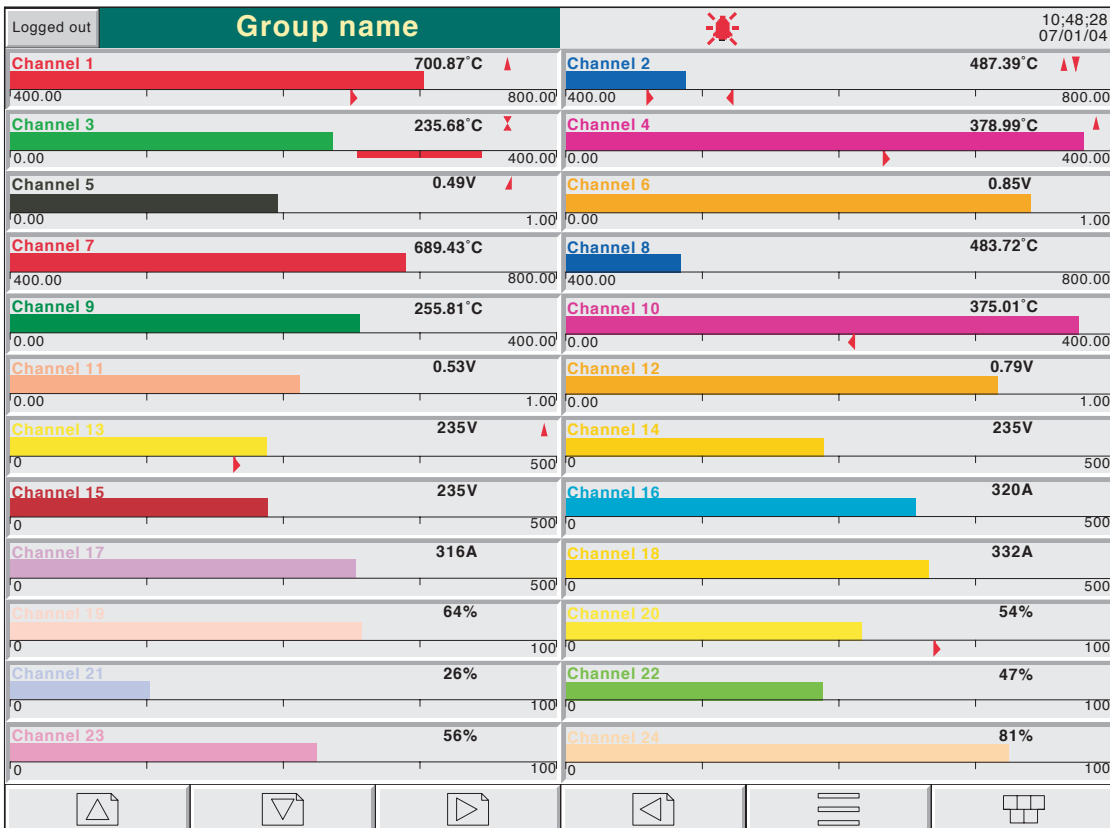

Figure 3.4.4b Horizontal bargraph display (more than 12 points)

3.4 DISPLAY MODES (Cont.)

3.4.5 Numeric

Entered from Horizontal bargraph mode by means of the down arrow key, or selected using the [Root Menu](#) 'Goto View' key, this display mode shows the Process Variable (PV) values as digital values. The format (which is automatically selected) is based on the number of channels in the display group. Figures 3.4.5a, 3.4.5b and 3.4.5c, show typical examples of the one column (up to five points), two column (six to 18 points) and three column versions (19 to 24 points) of this display mode respectively (where 'points' means input channels, totalisers, counters, maths channels etc.). Within each version, the process variable display areas expand or contract to fill the screen.

Trend history mode is not available from this display mode.

A further click on the down arrow key returns to Vertical Trend Display mode described in [section 3.4.1](#) above, or if user screens are fitted and enabled, to the first user screen (Section 2 of the Options manual). Alternatively, any one of the enabled display modes ([section 4.3.4](#)) can be selected using the [Root Menu](#), 'Goto View' key.

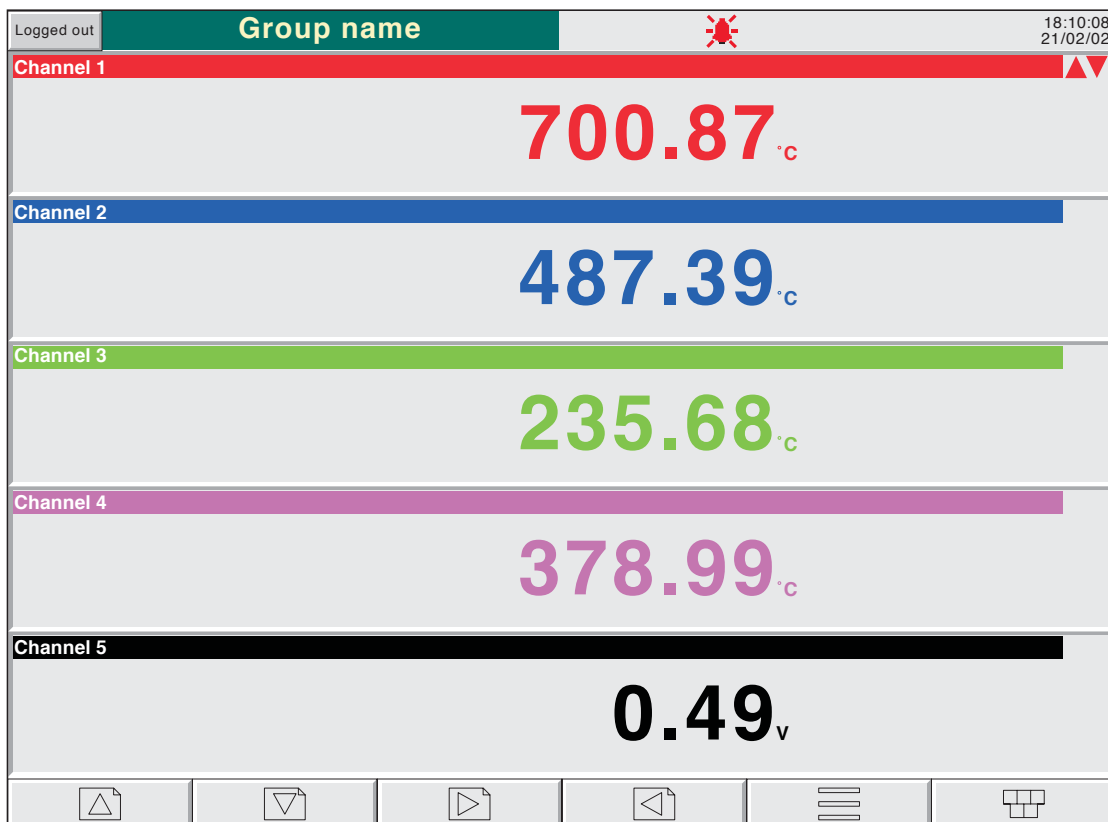

Figure 3.4.5a Numeric display mode (1 to 5 points)

3.4.5 NUMERIC DISPLAY MODES (Cont.)

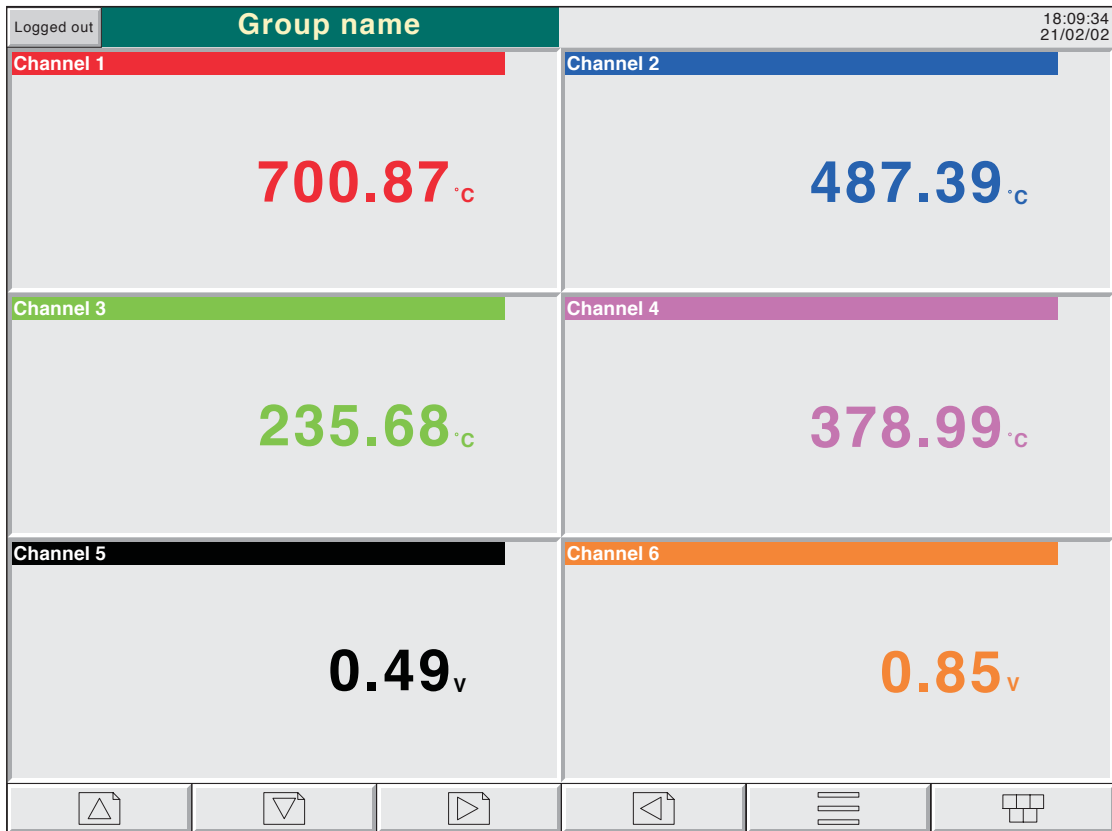

Figure 3.4.5b Numeric display mode (6 points)

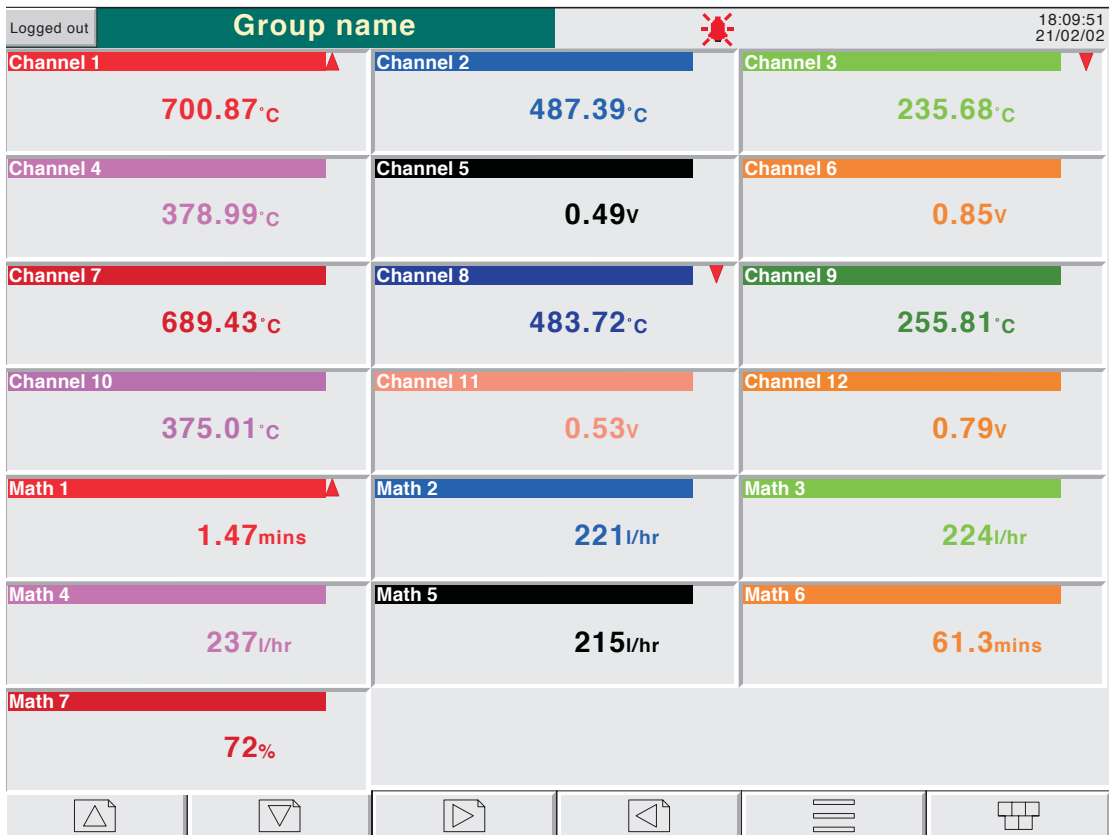

Figure 3.4.5c Numeric display mode (19 points)

3.4.6 Circular Trend Option

If this option is fitted, it replaces Vertical bargraph mode in the display scroll list, the Goto View menu and in the Views configuration page ([section 4.3.4](#)).

The option allows up to 12 points to be traced as though on a circular chart. More than 12 points can be included in the group, but only the first 12 traces and their associated faceplates are included in the real-time display. Entering Trend History mode (by using the Options button or by click/holding the screen for a few seconds), allows all the points to be reviewed, but only in vertical trend history mode, described in [section 3.4.1](#), above.

The option provides two alternative views called 'Full Screen' and 'Normal View'. These views are toggled between by means of a push-button key near the top left corner of the screen. In each case, faceplates can be displayed, or not, as required, using the Option key 'Faceplates On/Off' selection. The diameter of the chart is independent of faceplate on/off selection. When quitting History, Normal view is always returned to.

Note: Alarm marks ([section 3](#)) do not appear on circular trend scales.

TREND MODES

The way in which traces are laid down on the chart depends on the action to be taken when the chart is 'full', as set up in Group Configuration - [section 4.3.2](#). The user can select 'Rotate' or 'New Chart'.

ROTATE

In the following description, the word 'segment' is used interchangeably with 'Major chart division'. The number of Major chart divisions is a function of the selected chart speed, as described in Group Configuration ([section 4.3.2](#)).

With 'Rotate' selected, the traces start one major chart division anti-clockwise from the top of the chart and trace clockwise until they reach the top of the chart ('12 o'clock'). At this point, the chart, complete with time stamps and traces, rotates one major chart division anticlockwise, and the tracing process continues. When the chart is 'full', the oldest segment-full of tracing is removed, leaving an empty segment to be traced-on when the chart rotates.

Figures 3.4.6b and 3.4.6c, below show Circular trending in 'Rotate' mode.

NEW CHART

With 'New Chart' selected, tracing starts at top of the chart (12 o'clock) and continues to trace clockwise round the chart, back up to the vertical. When the chart is full, it is cleared, new timestamps are displayed, and tracing re-starts from the top of the chart.

The start time of the tracing can be set as a part ('Start at') of group configuration, the choices available depending on the time per revolution setting. The start time is placed at top centre of the chart, and 'backfilled', clockwise, round to the current time.

Figure 3.4.6a, below, shows New Chart mode.

Note: The use of '12 o'clock' above is intended to be illustrative and only to explain angles in terms of a normal analogue clock face. It does not mean that this position must actually be noon or midnight in real time.

3.4.6 CIRCULAR TREND OPTION (Cont.)

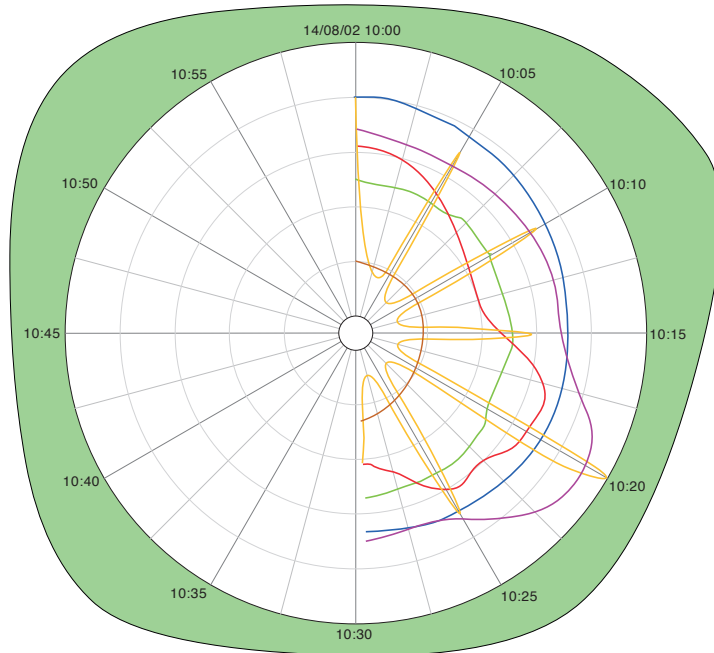

Figure 3.4.6a Circular trend - New chart mode

NORMAL VIEW

As shown in figure 3.4.6b, below, this provides a view of the chart, together with scale, chart speed, message bar and navigation keys. The figure shows a view with faceplates selected on.

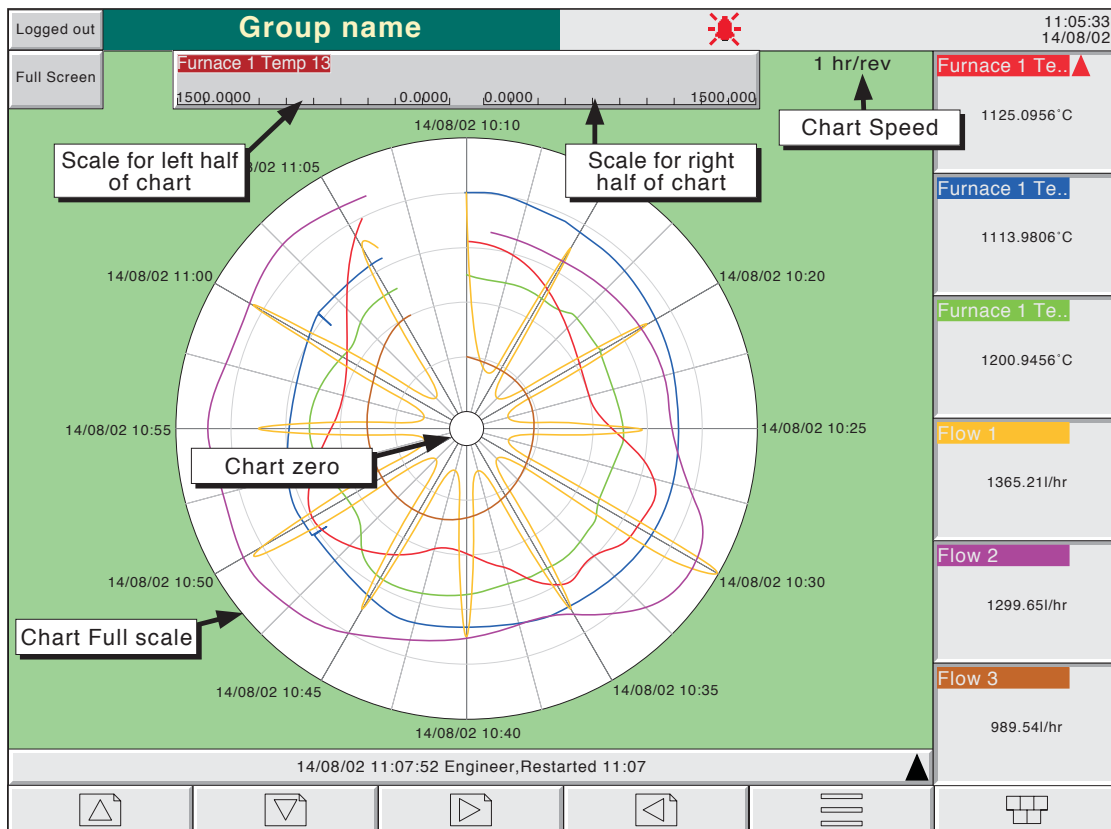

Figure 3.4.6b Circular Trend normal view (with faceplates)

3.4.6 CIRCULAR TREND OPTION (Cont.)

NORMAL VIEW FEATURES

| | |
|-------------|---|
| Scales | Two scales are provided, one for the left hand side of the chart, the other for the right hand side. Channel scaling is a part of channel configuration, as described in section 4.3.3 , below. The scales apply only to values along the horizontal line through the centre of the chart. Values for other angles (times) can be most easily found from the trend history , selected from the Option key, or by click/holding anywhere in the chart or in the green background area for a few seconds. |
| Chart speed | This displays the currently selected speed of revolution of the chart. This speed is set up as a part of Group configuration (section 4.3.2) |
| Faceplates | Up to 12 faceplates can be displayed, giving point values and alarm indication. |
| Message Bar | The message bar at the bottom of the screen displays the latest message. If an up arrow appears at the right hand end of the bar, there is more than one message. Clicking on the message bar calls a 'View Messages' window, detailing previous messages. See the description in section 3.4.2 for more details. |

FULL SCREEN DISPLAY

As shown in figure 3.4.6c, below, this maximizes the chart diameter, leaving only the chart, chart speed and faceplates (if selected on) on display. The figure shows a view with faceplates selected off. As the navigation keys are not available in this mode, Faceplate on/off selection can be made only from one of the other display modes.

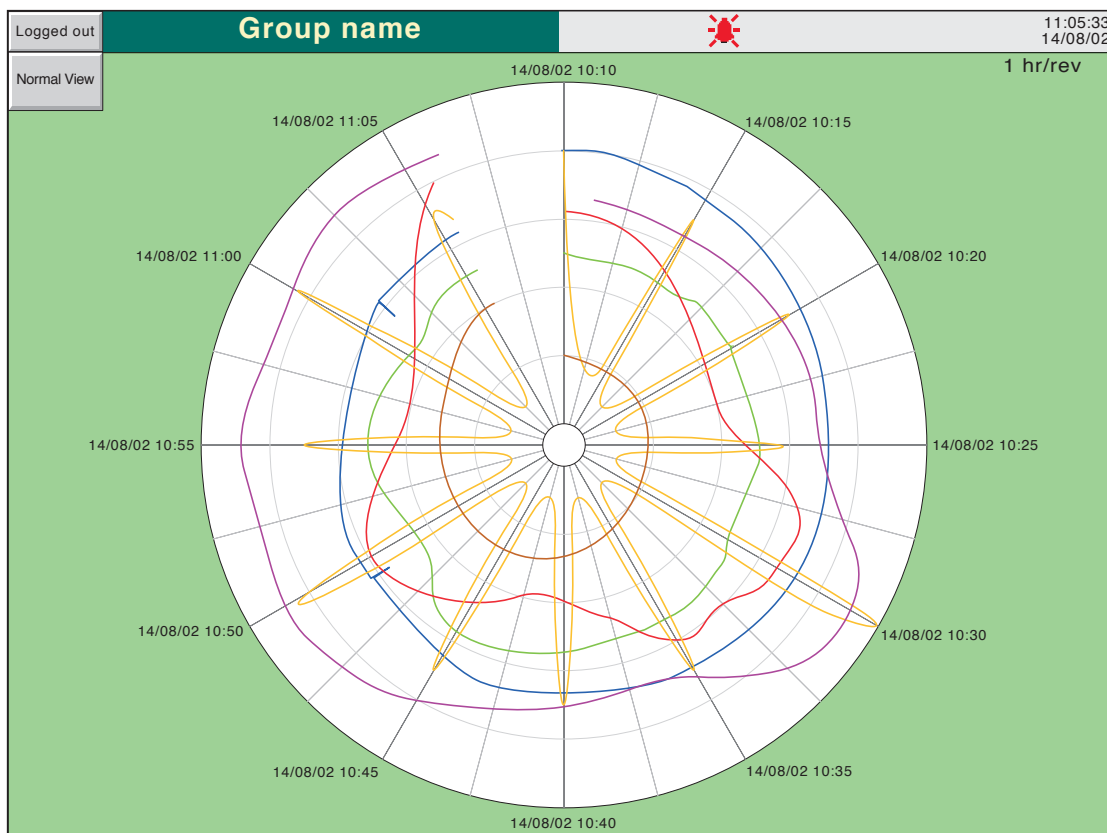

Figure 3.4.6c Circular Trend full screen view (with faceplates selected off)

FULL SCREEN FEATURES

| | |
|------------|---|
| Faceplates | As described above for Normal View features |
|------------|---|

3.4.6 CIRCULAR TREND OPTION (Cont.)

TIMESTAMPS

Time and/or date are displayed at every major chart division. The following rules apply:

1. For chart durations of a week or more, only the date is displayed
2. For chart durations of less than a week, both time and date appear, with the following exception:
In 'New Chart' mode (unless the chart 'bridges' midnight), the date appears only at top centre of the chart. All other chart divisions are identified by time only.

OTHER NOTES

1. In dark trend background, the chart is black against a 'white' background. Chart division lines are also in 'white'.
2. Adaptive recording results in two traces per trend, as in other trend display modes.
3. When the option is enabled, Circular Trend is the default home page.
4. For successful circular trend display, 'Circular Settings' must be enabled for the relevant group ([section 4.3.2](#)), and 'Circular Trend' must be enabled for the group, in Views configuration ([section 4.3.4](#)). If Circular Trend is enabled, but Circular Settings is disabled, then, although the circular chart will appear, it is unlikely that it will contain any trends.
5. The circular chart speed is unaffected by A/B switching of Trend Speed/Interval ([section 4.3.2](#))

3.5 OPERATOR NOTES

It is possible for the user to enter a note, of up to 60 characters, at any time, from any display page (not from configuration pages). Each note is associated with the current display group and becomes a part of that group's history. The notes appear on vertical and horizontal trend displays only, although they can be entered in any display mode.

The note appears on the chart and in the Message Log, preceded by the date, time and current full user name as shown in the first example below. If the Auditor Pack option is fitted, and 'Signing' is enabled, the note contains audit trail information, as shown in the second example below.

20/10/03 10:32:43 Frederick Bloggs, New Spray nozzles fitted to Line A, Tube 1.

Date and time Full User name Message

20/10/03 10:32:43 Note, Signed:Frederick Bloggs,Authorised:Engineer,New Spray nozzles fitted to Line A, Tube 1.

Date and time Audit trail information (if enabled) Message

To enter a message:

1. Click on the Option key, then on the 'Note' key
2. If necessary enter Signature and Authorization passwords (Auditor pack only - see [section 4.4.2](#))
3. Double-click within the note area of the resulting pop-up display.
4. Enter the required text of up to 60 characters (spaces are also counted as characters) using the pop-up keyboard display or the computer keyboard. Press Ok, Enter or Return when finished.
5. View the note and
 - a. click the Ok button to enter the note OR
 - b. double-click the text area to edit the note OR
 - c. press the Cancel key to quit note entry.

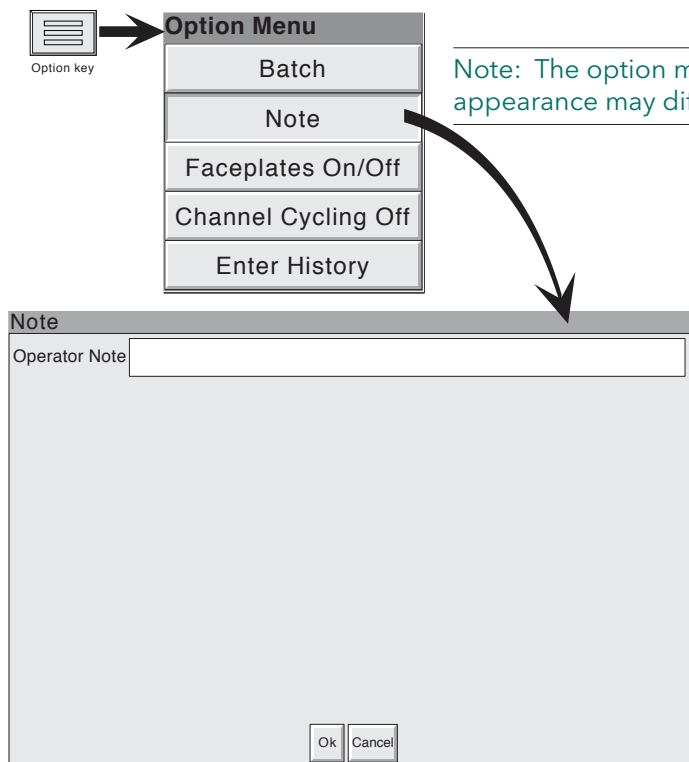

Note: The option menu is context sensitive, so its appearance may differ from the example shown

Figure 3.5 Access to message entry page

Note: Operator notes should not be confused with similar messages, appearing as a result of job action. Such messages are described in [section 4.3.8](#) of this manual.

4 SETTING UP THE DATA ACQUISITION UNIT

As described in the '[Access to Configuration](#)' (section 3.3.1) above, the setting-up of the instrument is divided into the following areas:

- [Archive](#) Section 4.1 - Allows manual archiving of data to a remote host ([FTP transfer](#)).
- [Save/restore](#) Section 4.2 - Allows new configurations to be created and saved, and saved configurations to be 'restored'. Save/Restore also allows the importing and exporting of User Screens can be carried out if the User Screens option is fitted.
- [Config](#) Section 4.3 - This is the major channel/alarm option etc. area of configuration.
- [Security](#) Section 4.4 - Allows passwords to be entered and edited and allows the Engineer-level password holder to enable/disable areas of configuration to Operator-level password holders. New users can be added, with their own user names, passwords and access level permissions.
- [Network](#) Section 4.5 - This area sets up the IP address/host names etc. used in FTP transfer, Remote Viewer and SNTP applications.
- [System](#) Section 4.6 - Allows time and date functions to be set and edited (including daylight saving start and finish dates, time zones etc.) The system key also allows the display language to be chosen, Option key codes to be entered, and contains an 'About' screen describing the software/hardware status of the unit.

Note: In all the following descriptions, if a change is made to a menu item, then the item text changes from black to red, until it is 'saved'

4.1 ARCHIVE

This allows archiving of data files, for all groups with 'Archive via FTP' enabled, to a remote computer. 'Archive via FTP' is enabled/disabled as part of ([Group configuration - section 4.3.2](#))

In order to carry out a successful transfer, details of the remote host must be entered in the Archive section of the 'Config' menu ([section 4.3.5](#)).

Note: An FTP server must be running on the remote host.

Figure 4.1 shows the archive menu. The Archive last hour/day/week etc. keys allow the user to determine which files are to be archived. Selection of 'Bring Archive Up To Date' causes the instrument to select whichever of the Last Hour/Last Day etc. categories is appropriate in order to bring the archive up to date. The 'Last Archive' window shows the time and date of the previous archive. The Archive Transfer window shows archive status as 'Active' or 'Inactive'.

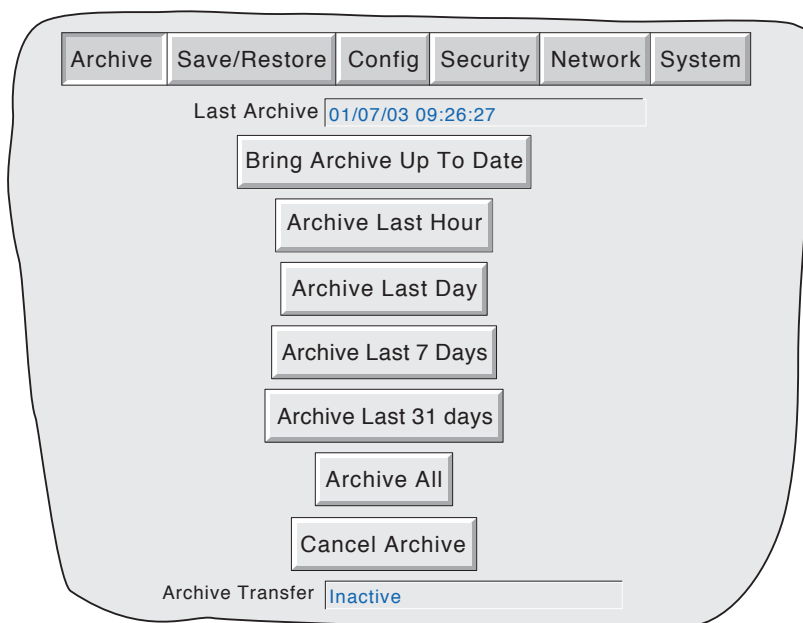

Figure 4.1 Remote archive strategy configuration

Note: The archive functions described above can also be carried out by job action - see [section 4.7.15](#).

4.2 SAVE / RESTORE

As shown in figure 4.2a, clicking on the 'Save/Restore' key calls the picklist: Save, Restore, New, Text, Import/export user screens, Import/export User Linearisations. Where a filename has to be entered, this is selected as follows:

Click on the filename window. This causes a pop-up menu to appear, showing the contents of the current directory. The normal PC directory browse system allows the user to choose a already existing filename, or to type-in a new name either in the current directory or in another directory as required.

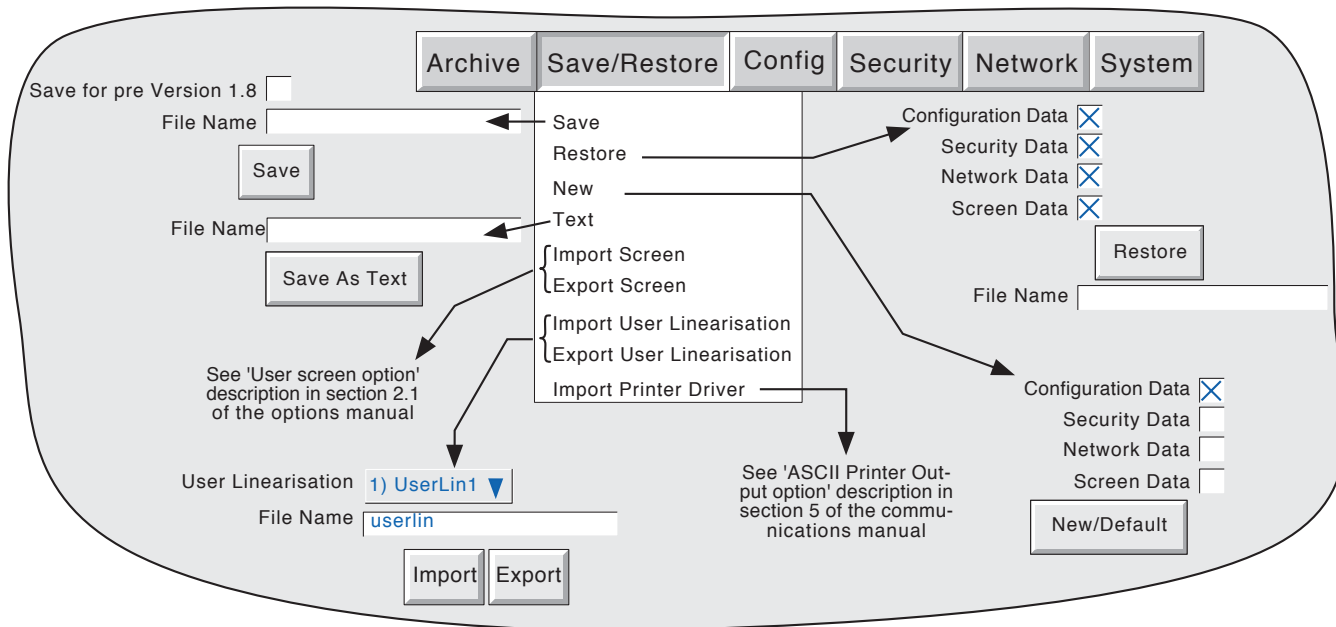

Figure 4.2 Save/Restore menu

4.2.1 Save

Clicking on this item allows the current configuration to be saved to the selected location. Files saved in this way are not in a 'readable' format and are used only for archive /security purposes or for transfer to another, similar, instrument.

SAVE FOR PRE VERSION 1.8

Clicking this box, prior to saving a configuration, means that the configuration can successfully be loaded (Restored) into other instruments running software versions prior to 1.8. If the box is left unchecked, then Saved configurations can be Restored only to instruments running software versions 1.8 or higher. The message 'Unsupported File' appears if an attempt is made to restore an 'Unchecked' configuration into a pre version 1.8 unit. See [Section 4.6.5 \(About\)](#) for details of how to determine software version.

4.2.2 Restore

Clicking on this item allows the user to select a previously saved configuration file name, which will then be used as the current configuration. Clicking on the 'Restore' key completes the operation. Checkboxes allow one or more of Configuration Data, Security data (note 3), Network data and Screen data to be chosen for the restore function.

Notes:

- 1 Screen data restores faceplate status for vertical trend and vertical bargraph modes, and user screen information if the option is fitted.
 2. If archiving is in progress when a 'Restore' is requested, the Restore operation will be delayed until the archive is complete (maybe several minutes). If required, the 'Cancel Archive' key (section 4.1 above) can be used to speed up the Restore process, at the cost of losing the archive data.
 3. If 'Centralised Security' is active (part of Security Management configuration - section 4.4.2) 'Security data is not selectable (either for 'Restore' or for 'New' (below)).
-

4.2.3 New

Clicking on this item causes the factory entered default configuration to be loaded for use, or for editing. Click in the New/Default key completes the operation. Checkboxes allow one or more of Configuration Data, Security data (note 3, above) and Network data to be chosen for the restore function.

For instruments with the User Screens option (Section 2 of the Options manual), a further tick box is displayed - 'Screen Data'

4.2.4 Text

This is identical to the 'Save' function described above, but the configuration is saved in ASCII format, and can be transferred to a computer and read, printed etc. as required. It is not possible, using this means, to modify the configuration and then re-load it.

4.2.5 Import screen

This field appears only if the User Screens option (Section 1 of the Options Manual) is fitted, and allows a previously exported User Screen file to be imported.

4.2.6 Export screen

This field appears only if the User Screens option (Section 1 of the Options manual) is fitted, and allows a User Screen to be exported to a selected location in the pc. The exported screen can subsequently be imported either into this unit or into a different unit.

4.2.7 Import User Linearisation

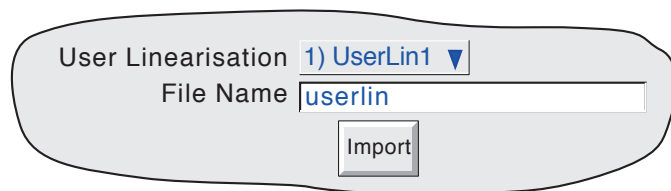

The Import Linearisation feature allows linearisation tables to be imported from the host PC

Touching the User Linearisation field allows the user to select which of 'UserLin1' to 'UserLin4' is to contain the imported file.

Touching the File Name field, allows the user to select the table to be imported.

The file must be comma separated ASCII as follows:

```
n,  
X1,Y1  
X2,Y2  
X3,Y3  
.  
.  
Xn,Yn
```

where 'n' is the total number of XY pairs in the table, and for each pair, X is the input value, and Y is the linearised value corresponding to X. See [section 4.3.9](#) for full details.

Note: Imported linearisation tables will not become effective until after the next configuration 'Apply' operation

4.2.8 Export User Linearisation

Similar to 'Import user Linearisation, above, the Export Linearisation feature allows linearisation tables created in the instrument to be exported to the host PC

See [section 4.3.9](#) for full details.

Note: If an exported linearisation table is to be used in a recorder or data acquisition unit with software version prior to version 2.2, it must be exported in Numeric format (i.e. not in Scientific format).

4.2.9 Import printer driver

This field appears only if the ASCII Output Printer option is fitted.

Similar to 'Import user Linearisation', above, this allows driver (.uhi) files for new printer types to be imported from the host PC. See section 5 of the Communications manual for further details.

Note: Imported printer drivers do not become effective until after the next configuration 'Apply' operation.

4.3 CONFIGURATION

Clicking on this key calls the top level configuration pick list: [Instrument](#), [Groups](#), [Channels/Alarms](#), [Views](#), [Archive](#), [Events](#), Messages etc. as shown in the overview figure (figure 4.3).

When making changes to the configuration the name of each changed parameter is displayed in red (instead of the normal black) until the 'Apply/Discard' key has been operated. For example, in channel configuration, if a thermocouple were to be changed from Type J to Type K, 'Lin Type' would appear in red, until the Apply key was operated.

Should an attempt be made to leave configuration with unsaved changes, a warning message appears, allowing the user to apply the changes, to discard the changes or to return to configuration (Cancel).

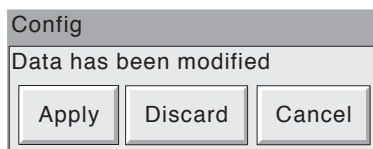

4.3 CONFIGURATION (Cont.)

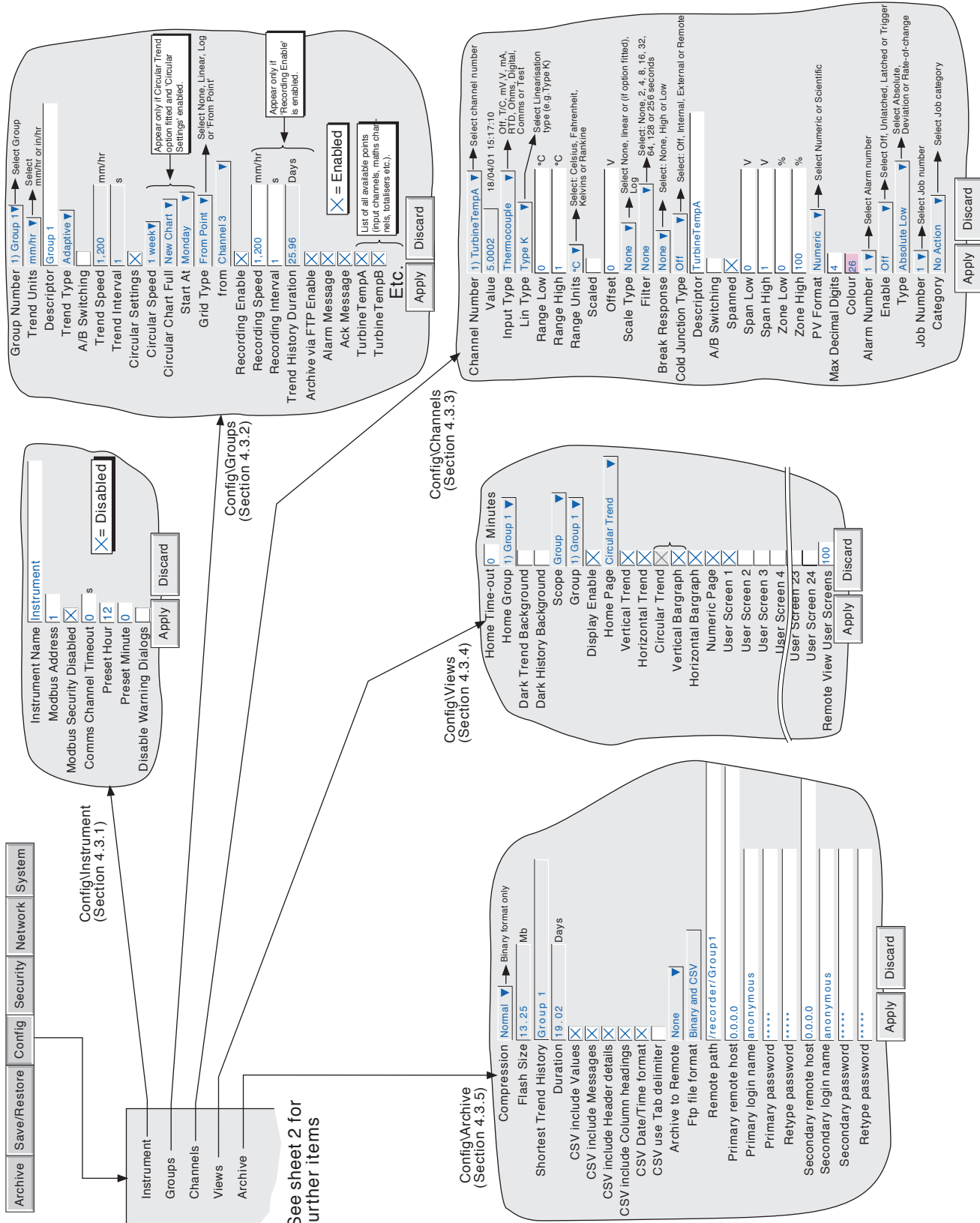

Figure 4.3 Configuration menu overview sheet 1

4.3 CONFIGURATION (Cont.)

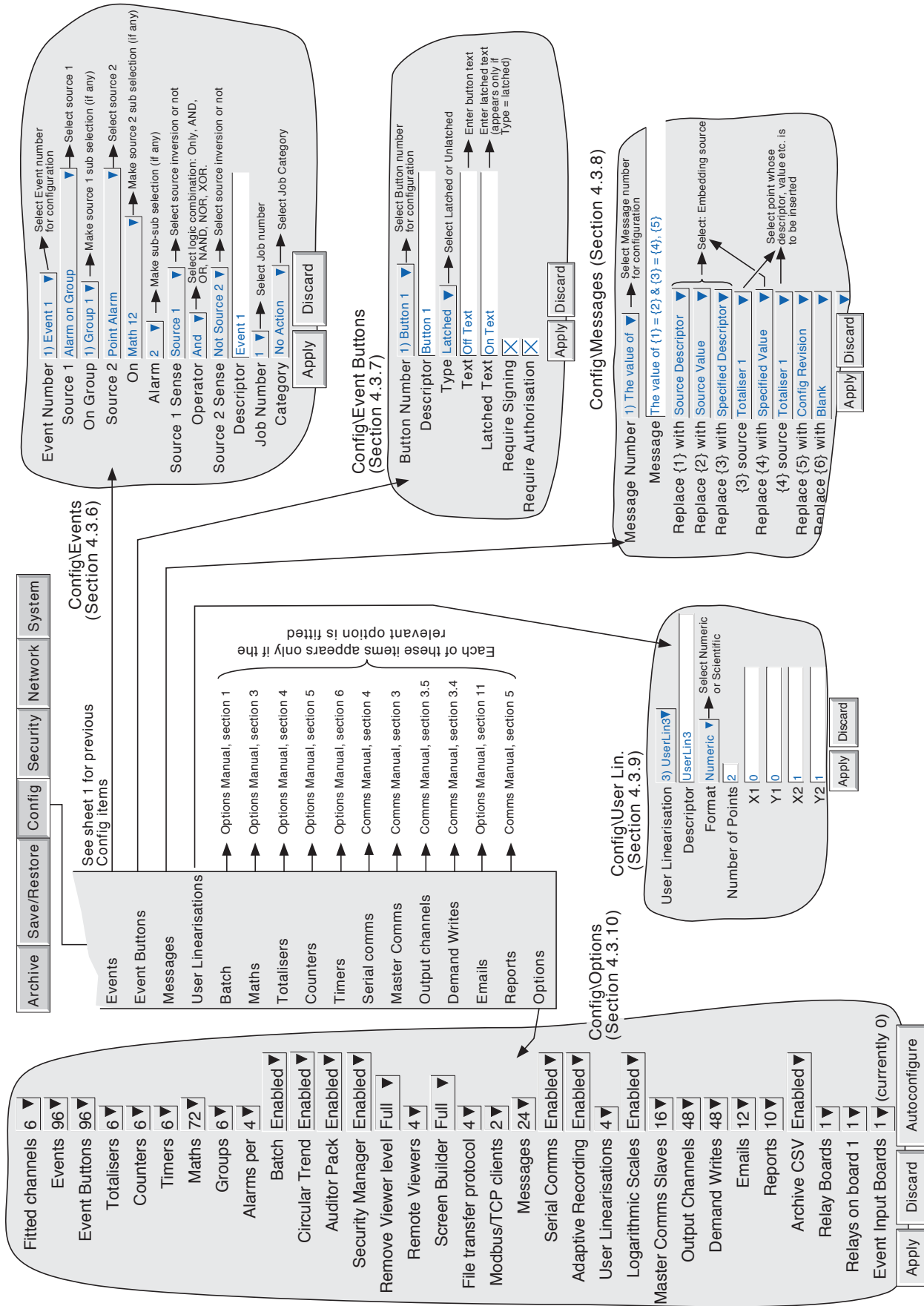

Figure 4.3 Configuration menu overview sheet 2

4.3.1 Instrument configuration

The screenshot shows a configuration menu with the following fields and values:

- Instrument Name: Instrument
- Modbus Address: 1
- Modbus Security Disabled: (A callout box indicates X = Disabled)
- Comms Channel Timeout: 0 s
- Preset Hour: 12
- Preset Minute: 0
- Disable Warning Dialogs:

At the bottom of the menu are two buttons: "Apply" and "Discard".

Figure 4.3.1 Instrument Configuration menu

INSTRUMENT NAME

Allows the entry of an alphanumeric name for the instrument, up to 20 characters long. See [section 3.3.1](#) for text entry techniques.

MODBUS ADDRESS

Allows a modbus address between 1 and 247 to be set up for Modbus slaves.

MODBUS SECURITY DISABLED

When using MODBUS, it is possible, by 'checking' this field to allow a host computer to access the instrument without its first having to supply a valid User name and Password. This box must be checked if this unit is acting as a Modbus slave in order for the unit to be detected. Once communications have been established, Modbus security can be enabled, providing that the Slave's Remote user name and password have been entered at the Master. See also section 2.2.4 of the Communications Manual.

COMMS CHANNEL TIMEOUT

Allows a number of seconds (between 1 and 999) to be entered. If none of the channels set to 'Comms' is communicated with, within this period, an event source (Comms channel timeout) is set, and remains set until the next communication. An entry of 0 disables the time out.

PRESET HOUR

Enter an hours number between 0 and 23 for use with [Clock Job - Preset clock](#).

PRESET MINUTE

Enter a minutes number between 0 and 59 for use with [Clock Job - Preset clock](#).

Note: See [section 4.7](#) for a description of jobs, and [section 4.5.1](#) for further details of time synchronisation.

DISABLE WARNING DIALOGS

Checking this box prevents [instrument alarm messages](#) from appearing on the screen.

4.3.2 Group configuration

Note: Group 1 is a standard feature. The supply of groups two to six (Multiple groups) is an optional extra.

Group configuration allows the user to define the following:

- a Group trend speed/interval.
- b Group recording speed/interval.
- c Group descriptor.
- d Group content.
- e. Circular Trend option speed and chart-full operation.
- f. Chart grid divisions

The production of alarm messages and the saving of group data to Flash memory, or to remote computer (FTP transfer) can also be enabled / disabled from this menu.

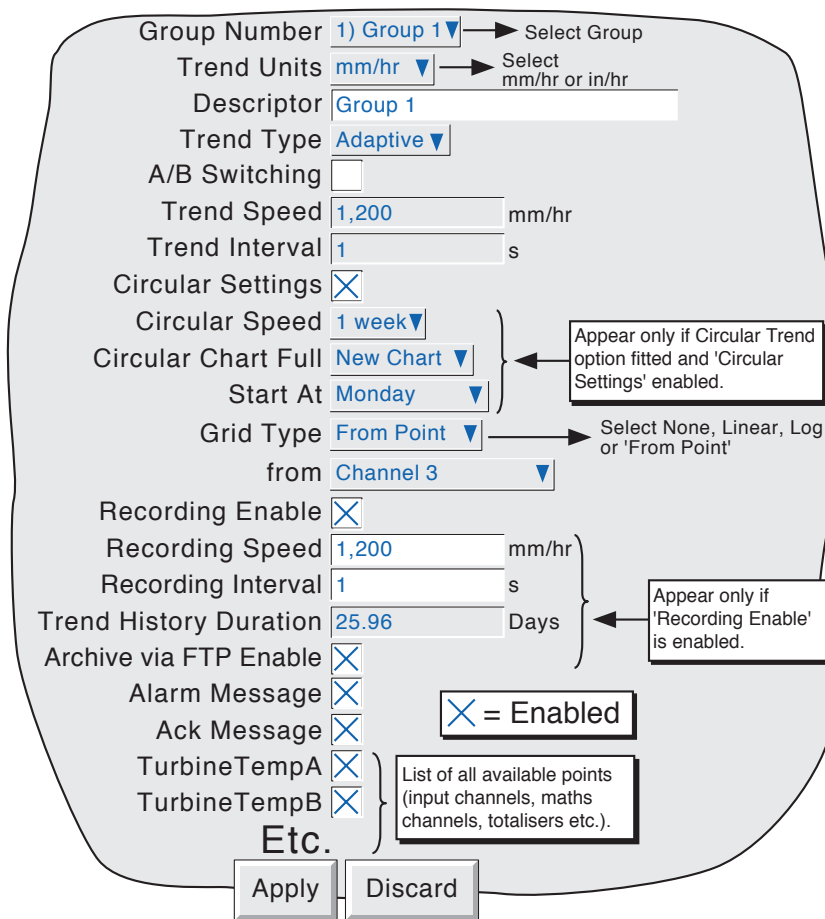

Figure 4.3.2a Group configuration menu

4.3.2 GROUP CONFIGURATION (Cont.)

GROUP NUMBER

For units with Multiple Groups fitted, this allows a particular group to be selected for configuration. Otherwise, only Group 1 is available.

TREND UNITS

Allows mm/hr or inches per hour to be selected for the 'chart' speed. Automatically converts the trend speed field below.

DESCRIPTOR

Allows the group name to be edited. See [section 3.3.1](#) for text entry techniques.

TREND TYPE

This allows the selection of Adaptive Recording for vertical and horizontal trend modes. The purpose of adaptive recording is to ensure that rapid, short duration spikes (for example), are represented on the 'chart' even at low trend speeds. This allows the user to extend the total amount of history stored (by using slow trend speeds) without losing transient data.

The adaptive recording method works by measuring the input signal at the normal 125msec period, and saving the maximum and minimum values, continuously, over the period of trend update. When the trend is updated, both maximum and minimum values are traced on the chart - i.e. two traces are produced for each channel in the group.

The faceplates and pen positions are still updated every second, as normal.

Notes:

- 1 During the period between updates, the maximum and minimum values are shown on the trend as a horizontal line just beneath the pen, where the ends of the line represent the minimum and maximum values so far. This line is removed at trend update time.
- 2 Adaptive recording takes twice as much memory as normal recording, so an increase in the total amount of history stored, occurs only if the trend speed is reduced to less than half of that which would normally be used.
- 3 In Trend History mode, both minimum and maximum values for the cursor position are shown on the faceplate. See [section 3.4.1](#) for a description of trend history

Figure 4.3.2b shows the difference between normal and adaptive recording, at slow trend rates. Note that rapid changes in signal, (such as those shown in the circled area of the 'actual signal') are largely filtered out by Normal Tracing, but is displayed by the Adaptive Trace. Figure 4.3.2b is for illustrative purposes only, as traces such as these could never appear on the chart together.

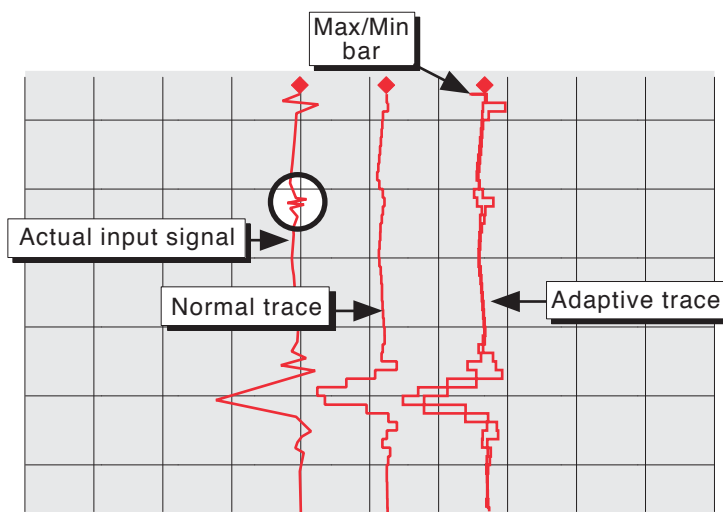

Figure 4.3.2b Adaptive recording compared with Normal tracing

4.3.2 GROUP CONFIGURATION (Cont.)

A/B SWITCHING

If enabled, this function allows alternative values for Trend speed/interval and Recording speed/interval to be entered. 'A' values are used during normal operation. 'B' values are switched to by job action, as described in [section 4.7](#)

TREND SPEED/TREND INTERVAL

Allows the 'chart' speed to be selected either as mm or in per hour, or as an interval. Entering a value in one field automatically converts the value in the other field. A trend interval of N seconds is equivalent to 1200/N mm/hr chart speed; a chart speed of P mm/hr is equivalent to a trend interval of 1200/P seconds.

If A/B switching is enabled, a second Trend Speed /Interval value can be entered. Trend Speed/Interval 'A' is used during normal operation. Trend Speed/Interval 'B' is switched to by job action, as described in [section 4.7](#)

Note: Trend speed/interval are not editable fields if 'Circular Settings' is enabled. The Circular Settings check box, described below, appears only if the Circular Trend option is fitted.

CIRCULAR SETTINGS

This checkbox appears only if the Circular Trend option is fitted, and, when checked, causes the Circular Speed/Chart Full/Start At fields, described below, to appear. When checked, the Trend Speed and Trend Interval fields described above are disabled (i.e. they are no longer editable).

Notes:

- 1 The following Circular Chart fields appear only if the Circular Trend option is fitted, and 'Circular Settings' is enabled, as described above.
- 2 If Circular Settings is not enabled, here in Group configuration, but Circular Trend is enabled for the group in Views configuration ([section 4.3.4](#)), then, although the circular chart will appear, it is unlikely that the chart will contain any trends.

CIRCULAR SPEED

This field allows the chart speed to be selected from a pick list, as detailed in table 4.3.2, below. The table also shows the number of major and minor chart divisions.

CIRCULAR CHART FULL

This allows 'New Chart' or 'Rotate' to be selected from a picklist. See [section 3.4.6](#) for details. Table 3.4.2 shows the major and minor chart divisions for each chart speed.

START AT

This item, (which appears only if 'New Chart' has been selected in 'Circular Chart Full', above) allows the user to select a start time and/or date for the new chart. The exception is for a chart speed of 1 hr/rev, which always starts on the hour.

| Chart spd. (hours/rev) | Chart divs | | New Chart Start at | |
|---------------------------|------------|-------|----------------------------|---|
| | Major | Minor | Start at choices | Examples/comments |
| 1 | 12 | 2 | On the hour | |
| 2 | 12 | 2 | | |
| 4 | 12 | 2 | | |
| 6 | 12 | 2 | | |
| 8 | 8 | 2 | 00 to 23 at 00:00 hrs | 4 hours/rev.; Start at 12. This chart will start at 1200 hrs and re-start at 1600, 2000, 2400, 0400, 0800 hrs etc. |
| 12 | 12 | 2 | | |
| 16 | 8 | 2 | | |
| 24 | 12 | 2 | | |
| 48 | 12 | 2 | | |
| 168* | 7 | 4 | Day of week at 00:00:00 | 48 hrs/rev.; Start Monday. Chart starts Mon. 00:00:00 and restarts Weds, Fri etc, |
| 336* | 7 | 4 | Day of week at 00:00:00 | At each power-on, the system resets to the first week of the period, with the most recent 'Start at' day of the week at the top of the chart. |
| 672* | 4 | 7 | | |
| 720* | 30 | 0 | | |

* 168 hrs = 1 week; 336 hrs = 2 weeks; 672 hrs = 4 weeks; 720 hrs = 30 days.

Table 4.3.2 Circular chart speed details

4.3.2 GROUP CONFIGURATION (Cont.)

GRID TYPE

Grid type allows the chart grid type to be defined for the group being configured. This is not necessarily related to channel scale ([section 4.3.3](#)), unless 'From point' is selected, when the grid matches the scale of the selected point.

NONE

No chart grid is traced.

LINEAR

The chart grid is linear, with the major and minor divisions defined by the fields Grid Divisions - Major and Minor, which appear if 'Linear' is selected as grid type.

Figure 4.3.2c, below, defines major and minor divisions.

LOG

This menu item appears only if the Log Scales option is fitted.

The chart grid is logarithmic, with the number of decades being selected in the 'Grid Decades' field which appears if 'Log' is selected as Grid Type. Figure 4.3.2c gives an example.

FROM POINT

This allows the chart grid to be aligned with the scale of a particular 'point', selected in the 'from' field which appears if 'From Point' is selected as 'Grid Type'

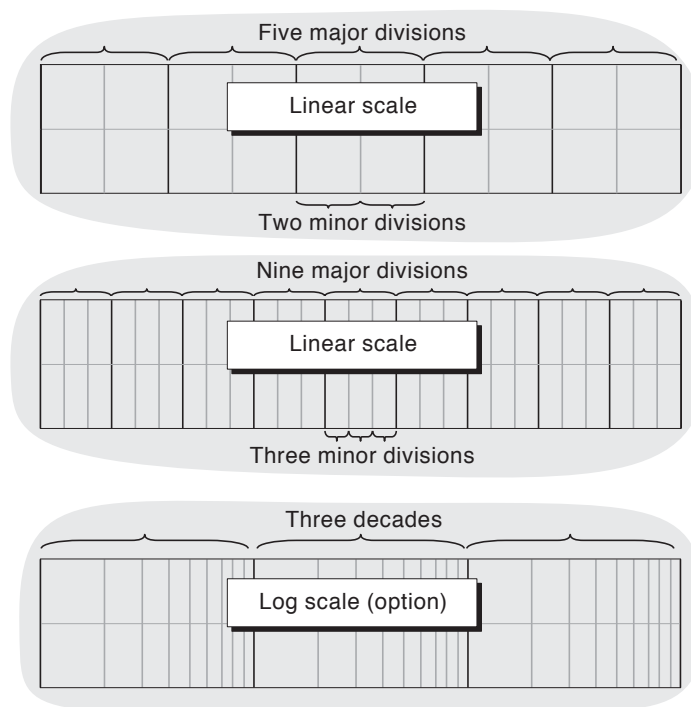

Figure 4.3.2c Chart grid definitions

RECORDING ENABLE

This tick box allows the logging of this group's data to the flash memory to be enabled/disabled. When disabled:

- The recording speed/interval and Trend history duration fields do not appear.
- Display trends are not preserved when changing 'Views'.

Note: If a 'Recording' job ([section 4.7.10](#)) are set to act on a particular group, then the group will be recorded only whilst the job is active, and only if Recording is enabled for the group.

4.3.2 GROUP CONFIGURATION (Cont.)

RECORDING SPEED/RECORDING INTERVAL

If recording is enabled, these fields are as for trend speed/interval but define the rate at which data is saved to Flash memory. This value also affects how much trace history appears per screen height in trend history mode ([section 3.4.1](#)). If recording is not enabled, these fields do not appear.

If [A/B switching](#) is enabled, a second Recording Speed /Interval value can be entered. Recording Speed/Interval 'A' is used during normal operation. Recording Speed/Interval 'B' is switched to by job action, as described in [section 4.7](#)

TREND HISTORY DURATION

Gives an estimated time to fill the group's trend history area of the Flash memory. The calculation is based on the archive rate, the compression ratio, the flash size and on the exact nature of the data. (Rapidly changing values use more space than static/slowly changing values.)

For units with more than one group, changing the contents of one group may affect the Trend History Duration of other groups. This happens because the unit attempts to store, as nearly as possible, the same amount of history for all groups, regardless of how many points there are in the groups.

For 'empty' groups, the Trend History Duration is displayed as '0' Days.

ARCHIVE VIA FTP

If recording is enabled, these tick boxes allow the archiving of this group's data to a remote host (FTP) to be enabled or disabled. If recording is disabled, these fields do not appear.

ALARM MESSAGE

This box allows the printing of alarm on and off messages on the 'chart' to be enabled (cross) or disabled (no cross) as required. Alarm messages appear on the trend display and in PC Review in the form HH:MM:SS Alarm ON n/m and HH:MM:SS Alarm OFF n/m, where 'n' is the relevant channel number and 'm' is the alarm number (1 or 2).

ACK MESSAGE

This tick box allows the printing of alarm acknowledgement messages on the 'chart' to be enabled or disabled as required. Acknowledge messages appear on the trend display and in PC Review in the form HH:MM:SS.

ALARM ACKNOWLEDGE

Alarms are acknowledged as described in [section 3.1.3](#).

GROUP CONTENTS

This appears as a number of tick-boxes, to include the ticked items in, or to exclude non-ticked items from, the group, as required. Each group may contain any or all of the measuring channels, maths channels and totalisers (if fitted), but only the first 36 will be displayed.

4.3.3 Channel/Alarm configuration

Figure 4.3.3a below, shows a typical configuration menu for an input channel. (For maths channels see Section 3 of the Options manual.) The actual fields that appear depend on what input type is selected, what linearisation type is selected, and so on.

The screenshot displays a configuration menu for 'Channel 1'. The 'Value' field shows 6.6893 and the timestamp is 18/09/02 16:02:10. The 'Input Type' is set to 'Thermocouple', and the 'Lin Type' is 'Type K'. A callout box indicates that 'Range Low', 'Range High', and 'Range Units' vary with the input type. Other settings include 'Scaled' (checked), 'Scale Low' and 'Scale High' (0 and 1 V), 'Units' (V), 'Offset' (0 V), 'Scale Type' (Linear), 'Scale Divisions - Major' (10), 'Scale Divisions - Minor' (1), 'Filter' (None), 'Break Response' (None), 'Cold Junction Type' (Internal), 'Descriptor' (Channel 1), 'A/B Switching' (unchecked), 'Spanned' (checked), 'Span Low' and 'Span High' (0 and 1 V), 'Zone Low' and 'Zone High' (0% and 100%), 'PV Format' (Numeric), 'Max Decimal Digits' (4), 'Colour' (red), 'Alarm Number' (1), 'Enable' (Unlatched), 'Type' (Absolute High), 'Threshold' and 'Hysteresis' (0 V), 'Dwell' (0 s), 'Job Number' (1), 'Category' (Drive Relay), 'Relay Board' (1), 'Relay Number' (1), and 'while' (Active). 'Apply' and 'Discard' buttons are at the bottom.

Figure 4.3.3a Channel/alarm configuration menu (typical)

Notes

1. Numeric values (e.g. 'input low') can be up to 10 characters including decimal point
2. Refer to section 3.3.1 for numeric and text entry techniques.

4.3.3 CHANNEL/ALARM CONFIGURATION (Cont.)

Example: A type J thermocouple is used to measure a temperature range of 100 to 200 degrees Celsius. This thermocouple output is transmitted to the unit by a 4 to 20 mA transmitter, for display as an efficiency value between 0 and 100%. In such a case, the following values would be set up:

Input type = milliamp
 Input range low = 4.0
 Input range high = 20.0
 Scale low = 0.0
 Scale high = 100
 Scale units = %
 Linearisation range low = 100
 Linearisation range high = 200
 Linearisation type units = degrees C
 Linearisation type = Type J thermocouple.
 Input shunt value = 250 ohms

Note: The following description shows all possible fields. The unit itself edits the list and shows only those fields appropriate to the setup so far. For example, the 'Shunt' field appears only for mA input type.

CHANNEL NUMBER

The current channel and its descriptor are displayed. Clicking on the window area allows another channel to be selected for configuration.

VALUE

Shows the current value of the channel, together with either 'Unadjusted' or the date and time of channel adjustment.

INPUT TYPE

Select thermocouple, millivolt, Volt, milliamp, RTD, Ohms, Digital (not channel 1 or 7), Slave Comms, Test or Master Comms as input type. Slave Comms must be selected if the channel is to be written-to via Modbus. Master Comms must be selected if this channel is to read from another instrument. For details of Master Comms, see section 3 of the Communications Manual.

LIN TYPE

The following linearisation tables are available as standard:

Linear, square root, $x^{3/2}$, $x^{5/2}$, UserLin1, UserLin2, UserLin3, UserLin4 (see section 4.3.9 for details)

Thermocouple types B, C, D, E, G2, J, K, L, N, R, S, T, U, NiMo/NiCo, Platinel. Ni/NiMo, Pt20%Rh/Pt40%Rh

Resistance thermometer (RTD) types Cu10, Pt₁₀₀, Pt₁₀₀A, JPT₁₀₀, Pt₁₀₀₀, Ni₁₀₀, Ni₁₂₀, Cu₅₃.

For input ranges, accuracies etc. associated with the above thermocouple/RTD tables, see [Annex A](#).

INPUT LOW

Enter the lowest value to be applied to the input terminals (e.g. 4.00).

INPUT HIGH

Enter the highest value to be applied across the input terminals (e.g. 20.00).

SHUNT

Allows a shunt resistor value to be entered for input type = mA. Commonly used values are 100 ohms and 250 ohms. Note that shunt resistors are connected to the input connector. The instrument cannot detect whether a shunt is fitted, or if one is, what value it has. Therefore it is the responsibility of the user to ensure that the ohmic value of any shunt fitted matches the shunt value entered in this field.

4.3.3 CHANNEL/ALARM CONFIGURATION (Cont.)

RANGE LOW

Enter the lowest value of the required linearisation range (e.g. 100)

RANGE HIGH

Enter the highest value of the required linearisation range (e.g. 200)

RANGE UNITS

Selectable from degrees Celsius, degrees Fahrenheit, Kelvin or Rankine.

SCALED

This box allows the user to select low and high values and units for a scale.

SCALE LOW

Enter the scale value to correspond with input range low (e.g. 0).

SCALE HIGH

Enter the scale value to correspond with input range high (e.g. 100).

SCALE UNITS

Enter up to five characters of unit descriptor (e.g.%).

Note:**User linearisation tables units**

To set user linearisation table units to temperature units (°C for example), the Range Units selection box can be used.

To enter custom units, 'Scaled' must be selected. Scale low must be set to Range Low; Scale high must be set to Range High. The required Units string is entered in the Scale units text entry box.

OFFSET

Allows a fixed value to be added to or subtracted from the process variable. The unit's specified accuracy figures no longer apply if an offset is included.

4.3.3 CHANNEL/ALARM CONFIGURATION (Cont.)

SCALE TYPE

This field allows 'None', 'Linear' or (if the Log Scales option is fitted), 'Log' to be selected as scale type. For linear scales, the number of major/minor scale divisions can be selected. This does not affect the 'chart' grid divisions, which is set up as a part of Group configuration ([section 4.3.2](#)).

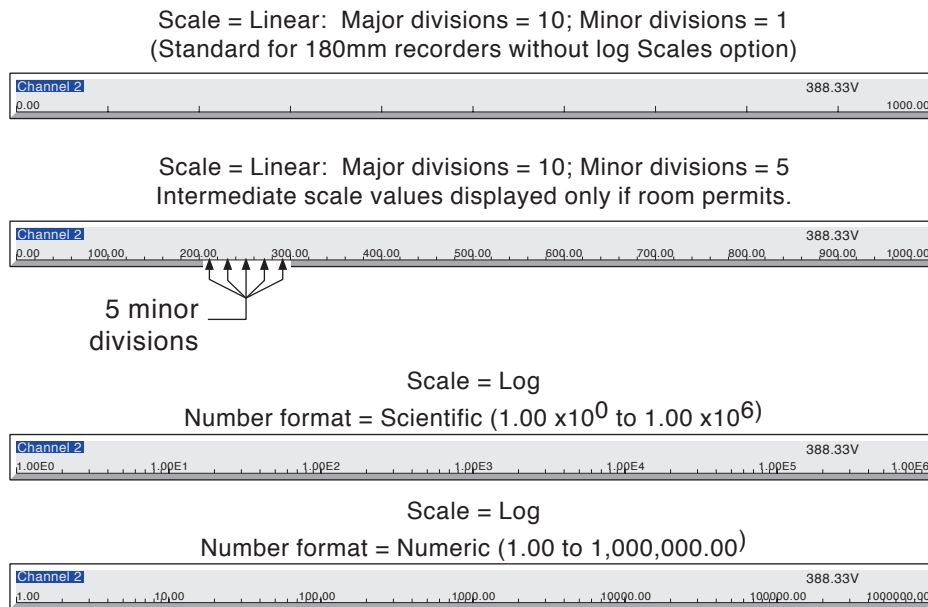

Figure 4.3.3b Scale type examples

NONE

Channels with Scale Type selected to 'None', appear with no scale information in any display mode.

LINEAR

Channels with Scale Type = Linear, appear with scale information in all display modes (except numeric). The number of major and minor divisions can be selected from subsequent fields. Examples are shown in figure 4.3.3b, above.

LOG

This menu item appears only if the Log Scales option is fitted. Channels with Scale Type = Log, appear with logarithmic scales. These scales have major divisions at each decade boundary, and (space permitting), minor divisions for mantissa values 2 to 9. Examples are shown in figure 4.3.3b, above. Because of the nature of logarithms, neither negative values nor the value 0 can be used as scale 'zero'.

SCALE DIVISIONS - MAJOR

Appears for Linear Scale types only. Setting major divisions to 1, means that the scale consists only of 'zero' and full scale. Setting Major divisions to 2, means that the scale has divisions at zero, 50% and full scale, and so on. Intermediate scale values appear at major divisions if there is sufficient space.

SCALE DIVISIONS - MINOR

Appears for Linear Scale types only. Setting minor divisions to 1, means that the scale major divisions are not divided i.e. no minor division tick marks appear. Setting Minor divisions to 2, means that each major scale division is divided into two, and so on. See figure 4.3.3b, above, for an example showing five minor divisions.

4.3.3 CHANNEL/ALARM CONFIGURATION (Cont.)

FILTER

For 'noisy' slowly changing signals, damping can be used to filter noise so that the underlying trend can be seen more clearly. None, 2, 4, 8, 16, 32, 64, 128 or 256 seconds can be selected.

It is not recommended that damping be used on quickly changing signals.

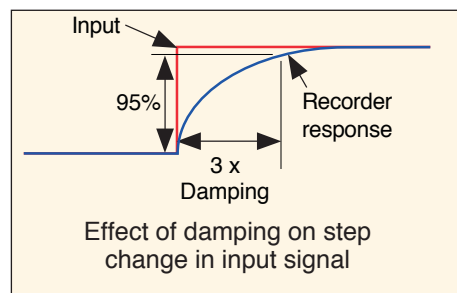

Figure 4.3.3c Channel filter

BREAK RESPONSE

For thermocouples and other low level inputs (i.e. input voltages less than 150mV), the unit can be made to respond in one of the following ways, if a break in the input circuit is detected.

- None trace drifts with the input wiring acting as an aerial.
- Drive hi trace placed at full scale
- Drive lo trace placed at scale 'zero'

COLD JUNCTION COMPENSATION (CJC)

For input type = thermocouple, None, Internal, External or Remote can be selected for cold junction compensation.

INTERNAL

Internal CJC is by means of an RTD connected across pins 11 and 12 of the input board connector.

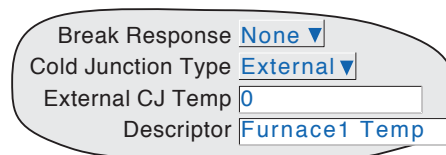

EXTERNAL

If the cold junction is maintained (by the user) at a known, fixed temperature, 'external' should be selected. An extra numeric entry box appears to allow the user to enter the temperature at which the cold junction is maintained.

REMOTE

'Remote' is selected if the cold junction temperature is to be measured by an external device connected to the instrument. An extra picklist appears which allows the user to select any input or maths channel to act as the cold junction temperature source channel. The temperature units displayed here, are those of the channel being configured, not those of the CJ source channel. The CJ source channel must be configured appropriately for the external device, and must provide a value which is consistent with the configured channel's units.

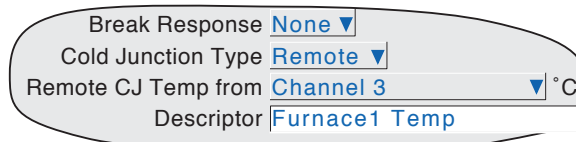

DESCRIPTOR

Allows a text string of up to 20 characters (including spaces) to be entered for the channel descriptor. (E.G. 'Turbine 2 tempA').

A/B SWITCHING

If enabled, this function allows alternative Span, Zone and Trace Colour values to be entered. 'A' values are used during normal operation. 'B' values are switched to by job action, as described in section 4.7

4.3.3 CHANNEL/ALARM CONFIGURATION (Cont.)

SPANNED

This box, when selected, allows span low and high values to be entered. For example, in an input range of 0 to 600 deg C, it may be that the temperature range between 500 and 600 degrees is of most interest. In such a case, setting span low to 500 and span high to 600 will cause the instrument to display only that part of the input range, and this will fill the zone width which is selected next, effectively magnifying the area of interest.

If A/B switching is enabled, a second set of span low and span high values can be entered. 'A' values are used during normal operation. 'B' values are switched to by job action, as described in [section 4.7](#).

ZONE

This allows the portion of the chart which the channel occupies to be defined in terms of percent, where the left edge of the chart is 0% and the right hand edge is 100%. For example, setting a low value of 50 and a high value of 100 causes the channel trace to be confined to the right hand half of the chart.

If A/B switching is enabled, a second set of zone low and zone high values can be entered. 'A' values are used during normal operation. 'B' values are switched to by job action, as described in [section 4.7](#).

PV FORMAT

This allows the PV value, alarm setpoints, hysteresis values etc. to be displayed as normal numeric values (Numeric) or in 'Scientific' format (Scientific). When 'Scientific' is selected, values are displayed and entered as a decimal number between 1 and 10[†] (the mantissa), followed by a multiplier (the exponent). E.G. to enter a value of 1244.5678, the value entered would be 1.2445678E3, where 3 represents the number of places that the decimal point must be shifted to the left in order to convert the value to a number between 1 and 10[†]. To enter a value of 0.0004196, the entry would be 4.196E-4.

† Notes

1. Strictly this is a number less than 10, as 10 would be 1.0E1.
 2. There must be at least one number after the decimal point.
-

MAXIMUM DECIMAL DIGITS

This defines the number of decimal places in the process value. Settable between zero and nine. Leading and trailing zeros are not displayed. Values too long for the available displaying width are truncated as described in [section 3](#).

COLOUR

Allows the trace colour to be selected from a colour chart. Each of the 56 available colours is displayed with a number, and it is this number which is entered. The background colour to the selection box changes to the selected colour.

If A/B switching is enabled, a second colour selection can be entered. Colour 'A' is used during normal operation. Colour 'B' is switched to by job action, as described in [section 4.7](#).

4.3.3 CHANNEL/ALARM CONFIGURATION (Cont.)

ALARM NUMBER

Allows alarm 1 to 4 to be selected for configuration.

ENABLE

Allows the alarm to be defined as Off, Unlatched, Latched or Trigger

| | |
|-----------|--|
| Off | Alarm is disabled and the remainder of the alarm configuration is hidden. |
| Unlatched | Unlatched alarms become active when the trigger source becomes active and remain active until the source returns to a non-active state. The indicator is on (flashing before acknowledgment - steady after acknowledgment) until the alarm clears. Alarm messages are printed if enabled in group configuration. |
| Latched | Latched alarms become active when the trigger source becomes active and remain active until the alarm is acknowledged AND the trigger source has returned to a non-active state. The indicator is on (flashing before acknowledgment - steady after acknowledgment) until the alarm has been acknowledged AND the trigger source has returned to a non-active state. Alarm messages are printed if enabled in group configuration. |
| Trigger | Continuous jobs remain active only whilst the alarm trigger source is active. I.E. the job finishes when the alarm clears, whether acknowledged or not. When triggered all associated jobs are initiated, and continuous jobs remain active until the alarm clears. There is no alarm indication, and no messages are printed. |

TYPE

This field appears only when the alarm Enable is not selected Off. Each alarm can be defined as absolute high, absolute low, deviation-in, deviation-out, rate-of-change rise or rate-of-change fall.

| | |
|----------------|---|
| Absolute High | As shown in figure 4.3.3d , an absolute high alarm becomes active when the channel value exceeds the threshold value. The alarm remains active until the channel value falls below (Threshold minus hysteresis). If a dwell value is defined, the alarm does not become effective until this dwell time has been exceeded. |
| Absolute Low | As shown in figure 4.3.3d , an absolute low alarm becomes active when the channel value falls below the threshold value. The alarm remains active until the channel value exceeds (Threshold + hysteresis). If a dwell value is defined, the alarm does not become effective until this dwell time has been exceeded. |
| Deviation in | As shown in figure 4.3.3e , a deviation-in alarm becomes active whenever the channel value enters the band: Reference \pm Deviation. It remains active until the channel value leaves the band: Reference \pm (Deviation+ Hysteresis). If a dwell value is defined, the alarm does not become effective until this dwell time has been exceeded. |
| Deviation out | As shown in figure 4.3.3e , a deviation-out alarm is active whenever the channel value leaves the band Reference \pm Deviation. It remains active until the channel value enters the band: Reference \pm (Deviation - Hysteresis). If a dwell value is defined, the alarm does not become effective until this dwell time has been exceeded. |
| Rate of change | As shown in figure 4.3.3f , rate of change alarms become active whenever the signal value changes by more than a specified amount within a specified period. If a dwell value is defined, the alarm does not become effective until this dwell time has been exceeded. An averaging period can be set to remove the effects of sudden, but short-lived changes, such as noise spikes on the signal. |

Note: Alarm icons appear at the display, as described in section 3 of this manual.

4.3.3 CHANNEL/ALARM CONFIGURATION (Cont.)

PARAMETERS

Figures 4.3.3d, e and f illustrate the following terms for the different alarm types.

| | |
|--------------|--|
| Threshold | For Absolute alarms, this defines the value (in engineering units) at which an alarm is triggered. The alarm also returns to its non-active state at this value unless a threshold value has been set. If a dwell value is set, the alarm does not become active until this dwell time has elapsed. |
| Hysteresis | <div style="display: flex; align-items: flex-start;"> <div style="flex: 1;"> <p>Defines a 'deadband' (in engineering units) to eliminate spurious triggering if the signal value is hovering around the trigger point. The deadband lies:</p> <ul style="list-style-type: none"> Below Absolute High thresholds Above Absolute Low thresholds Outside the deviation band for Deviation-in alarms Inside the deviation band for Deviation-out alarms. </div> <div style="border: 1px solid black; padding: 5px; margin-left: 10px; width: 300px;"> <p>EXAMPLE</p> <p>Threshold = 100 units; Hysteresis = 5 units A high alarm becomes active when its input rises above 100 and remains active until its value falls below 95 units. A low alarm becomes active when its input falls below 100 units, and remains active until its input rises above 105 units.</p> </div> </div> |
| Dwell | Allows a dwell period to be entered in seconds. The alarm does not take effect until this period has expired. If an alarm clears before the dwell period has expired, the alarm is ignored. |
| Reference | For Deviation alarms, this is the central value of the deviation band. |
| Deviation | For Deviation alarms, this value defines the width of the deviation band, each side of the reference value. I.E. the total width of the deviation band is 2 x Deviation value. |
| Amount | For Rate-of-change alarms, this value defines the amount by which the signal value would have to change, within the 'Change Time' period (below), in order for the alarm to become active. |
| Change Time | For Rate-of-change alarms, this selects the time period (Per second, Per minute, Per hour) within which the change in signal value must exceed the Amount value (entered in the preceding field) in order for the alarm to become active. |
| Average time | For rate-of-change alarms, this allows an average period to be entered for signal smoothing. |

4.3.3 CHANNEL/ALARM CONFIGURATION (Cont.)

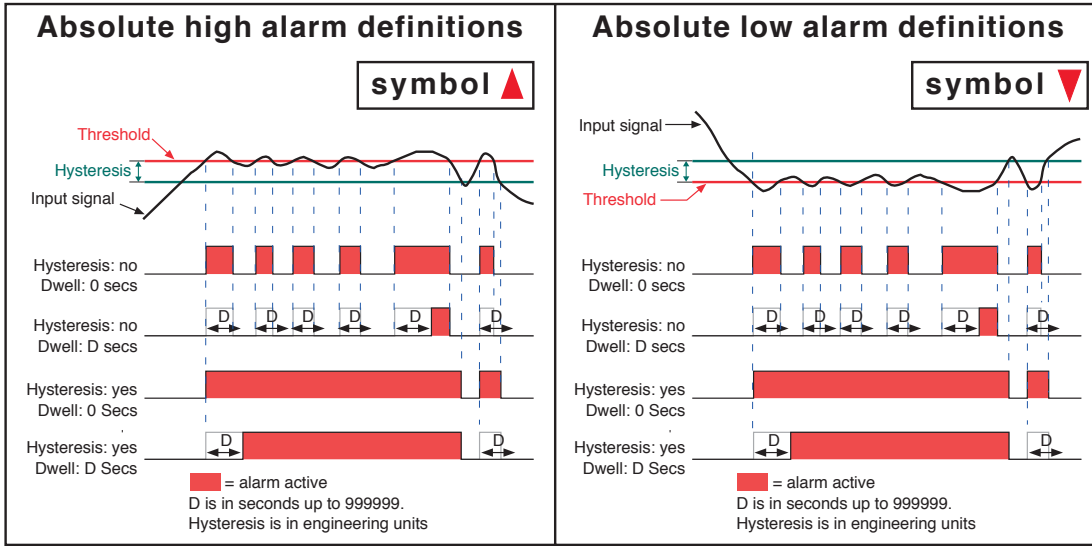

Figure 4.3.3d Absolute alarm definitions

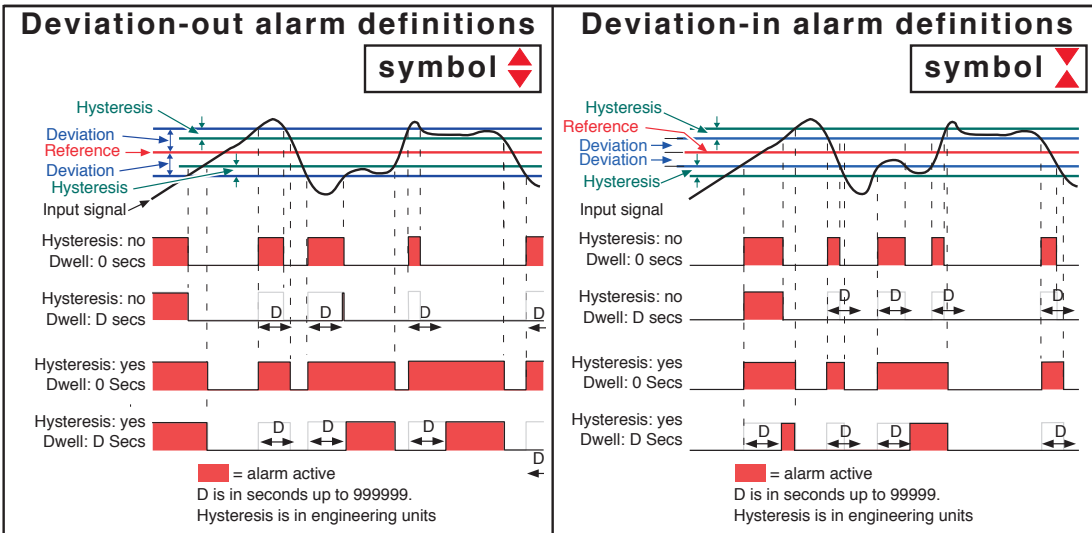

Figure 4.3.3e Deviation alarm definitions

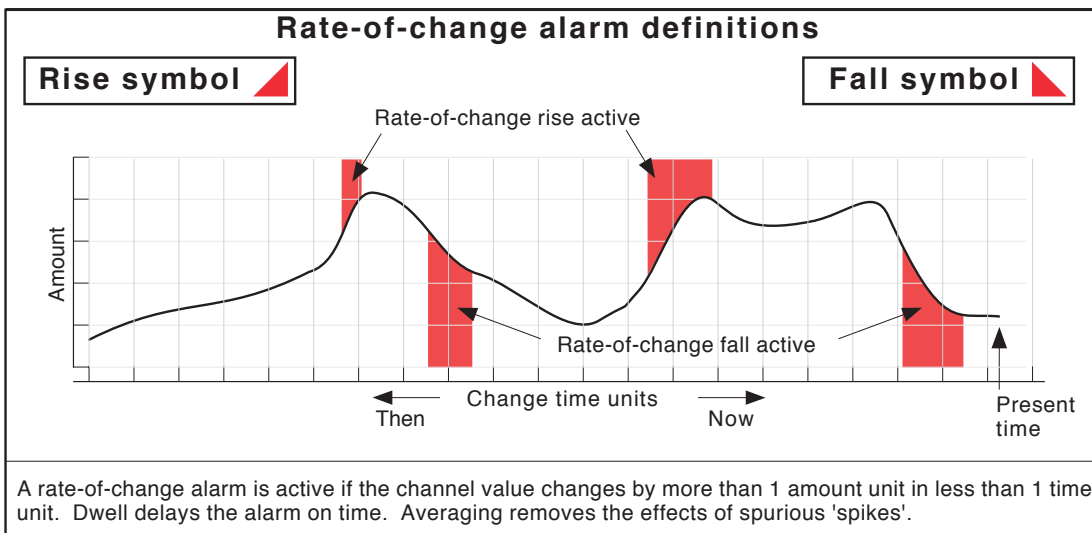

Figure 4.3.3f Rate-of-change alarm definitions

4.3.3 CHANNEL/ALARM CONFIGURATION (Cont.)

JOB NUMBER

Select the required job number.

CATEGORY

Select the required job to be carried out when the channel is in alarm (e.g. Drive relay) See [section 4.7](#) for a description of job categories.

WHILE/ON

Allows the action of the alarm job to be chosen as

- whilst active, whilst inactive or whilst unacknowledged for continuous jobs (e.g. drive relay), or,
- on going active, on going inactive or on acknowledgement for 'one-shot' jobs (e.g. increment counter).

Figure 4.3.3g, below, shows the various actions graphically. For 'While unacknowledged' and 'on acknowledgement' settings, two cases are shown, one where the alarm goes inactive before acknowledgement; the other where the alarm is acknowledged whilst the alarm is still active. The coloured (shaded) areas show the duration for which continuous jobs run; the down arrows show trigger points for 'one-shot' jobs. See [section 3.1.3](#) for details on how to acknowledge alarms.

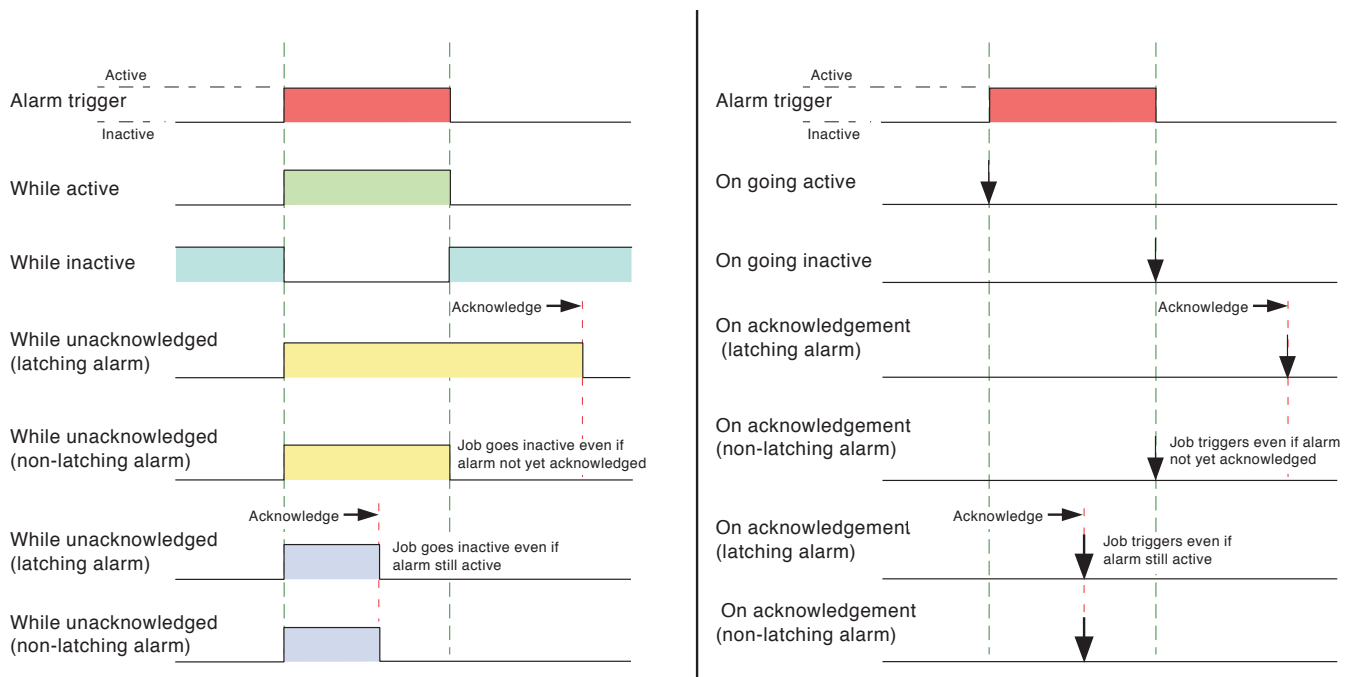

Figure 4.3.3g Graphical representation of job actions

ALARM MESSAGES

Alarm on/off and alarm acknowledge message printing on the chart can be enabled/disabled as a part of 'Group configuration' described below. See [section 3.1.3](#) for details on how to acknowledge alarms

4.3.4 Views Configuration

This part of the instrument's configuration allows groups to be set up (either individually, or globally) to include the various display modes described in section 3.4, above, and user screens (if fitted). When enabled, a display mode is added to the Group's 'Goto View' menu and to the up/down arrow scroll list.

Home Group and Home Page picklists allow a group and display mode to be defined for display when the Home key is clicked-on in the Root menu.

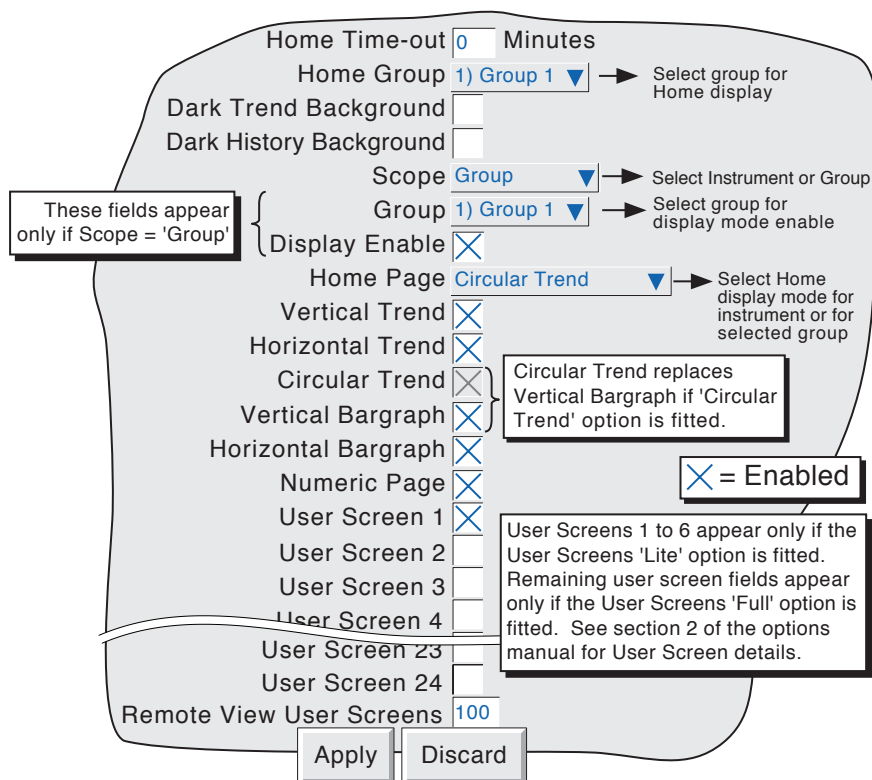

Figure 4.3.4a Views Configuration menu

HOME TIMEOUT

The specified home page is returned-to after the timeout value of minutes has elapsed since the last operator action. Timeout action is inhibited if a configuration is incomplete (there are changes which have not been 'Applied'), or if a system-generated message (e.g. 'Clock Failure') is on display. User displays (e.g. Root menu) are timed-out after approximately 50 seconds.

A value of zero disables the time-out function. Valid entries are between 1 and 99 minutes.

HOME GROUP

This picklist allows a particular group to be selected for display when the root menu 'Home' key is clicked-on.

DARK TREND/DARK HISTORY BACKGROUND

These tick boxes allow the user to select a black 'chart' for normal trending and/or trend history mode. These selections act globally (i.e. on all groups) and are alternatives to the normal white-chart trend displays, not additional to them.

4.3.4 VIEWS CONFIGURATION (Cont.)

SCOPE

The remaining items of Views configuration can be selected to act globally (Instrument) or to act on individual groups (Group). When 'Instrument' is selected, enabled display modes appear in all groups' up/down arrow scroll lists and are active in the Root Menu 'Goto View' menu (figure 4.3.4b). When 'Group' is selected, each group can be set up with individual display mode lists. For the particular group on display, the up and down arrow keys can be used to scroll through the enabled display modes, or a particular mode can be selected using the 'Goto View' menu.

GROUP

This field appears only if 'Scope' is set to 'Group', and allows each group to be selected for display configuration. For other items of Group configuration, see [Section 4.3.2](#).

Note: Group 1 is a standard feature. The supply of groups two to six (Multiple groups) is an optional extra.

DISPLAY ENABLE

This field appears only if 'Scope' is set to 'Group', and allows the selected group to be enabled or disabled for display. When enabled, the group can be displayed either by using the 'Root menu/Goto screens/Group N' selection (figure 4.3.4b) or can be scrolled-to using the right/left arrow keys. When disabled, the group is 'greyed' in the 'Root menu/Goto screens/Group N' selection and is skipped when using the right/left arrow keys. It is not possible to disable the Home group.

Notes:

- 1 If the Circular Trend option is fitted, this replaces Vertical Bargraph display mode. For illustrative purposes, figure 4.3.4a, above, shows both, but only one or the other may appear.
 - 2 If Circular Trend view is enabled here in Views configuration, but the 'Circular settings' checkbox is not enabled in Group configuration ([section 4.3.2](#)), then, although the circular chart will appear, it is unlikely that the chart will contain any trends.
-

HOME PAGE

Allows a particular display mode to be selected as the default display, either for all groups (Scope = instrument) or on a group-by-group basis (Scope = group).

DISPLAY MODE ENABLING

A series of check boxes allow the various display modes to be added to (or removed from) the up/down arrow scroll list and to be activated/deactivated in the Root menu 'Goto View' menu, either for all groups (Scope = instrument) or on a group-by-group basis (Scope = group). It is not possible to disable the selected Home page mode.

4.3.4 VIEWS CONFIGURATION (Cont.)

USER SCREENS 1 to N

This field appears only for recorders with the User Screens Option fitted. This option is fully described in section 2 of the Options Manual. Allows up to N user screens to be included in the up/down arrow scroll list and to be active in the Root menu 'Goto View' menu (figure 4.3.4b), where N is 6 for the User Screens 'Lite' option, or 24 for the 'Full' Version. Full version users also can define a number of extra user screens (user screens 25 onwards). Once created these screens can be copied to normal user screens if required.

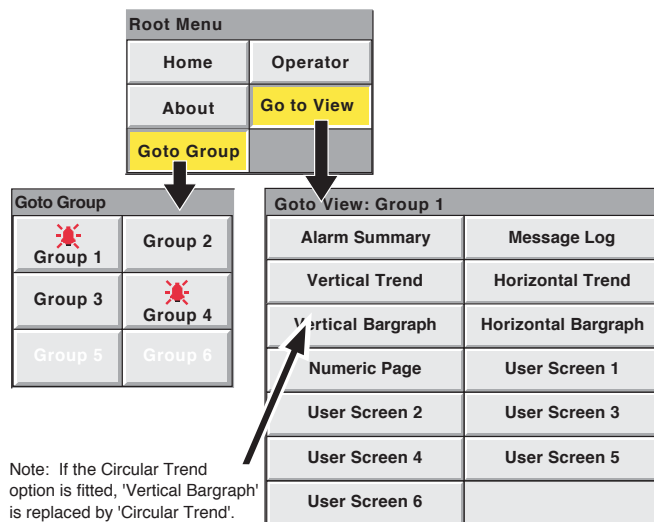

Figure 4.3.4b Goto View and Goto Group submenus (User Screens 'Lite' option fitted; Groups 5 and 6 disabled)

4.3.5 Archive configuration

Note: FTP File format appears only if the CSV option, described later in this subsection (4.3.5), is fitted.

This allows an archive strategy to be set up for saving data. If the CSV option is fitted, then files can be archived in Comma Separated Values (CSV) format and/or the standard Packed Binary (uhh) format. CSV format files are not as secure as Packed Binary format files.

A dedicated area of the unit's Flash memory is used as an archive data buffer, which means that data is written to the pc only when required, rather than continuously.

In order to carry out a successful archive, details of the remote host must be entered both in this Archive section of the 'Config' menu, and in Network configuration (section 4.5). Further, the current access level must have 'Connect from remote' enabled in the Security/Access menu (section 4.4.1).

The screenshot shows the 'Archive configuration' menu with the following fields and values:

- Compression: Normal (dropdown menu with arrow pointing right, text: Select: Normal or High)
- Flash Size: 13.25 Mb
- Shortest Trend History: Group 1
- Duration: 19.02 Days
- Archive to Remote: None (dropdown menu with arrow pointing right, text: Select archive interval)
- Ftp File format: Binary (dropdown menu with arrow pointing right, text: Appears only if CSV option fitted)
- Remote path: /recorder/Group1
- Primary remote host: 0.0.0.0
- Primary login name: anonymous
- Primary password: *****
- Retype password: *****
- Secondary remote host: 0.0.0.0
- Secondary login name: anonymous
- Secondary password: *****
- Retype password: *****

At the bottom of the menu are two buttons: 'Apply' and 'Discard'.

Figure 4.3.5a Archive configuration menu

COMPRESSION

Select Normal or high compression. 'Normal' compresses the data but still provides an exact copy. 'High' compresses more, but channel values are saved only to 1 part in 10^8 resolution. This field does not appear if 'CSV' is selected as file format (see below).

FLASH SIZE

Allows the size of the Flash memory to be viewed by the user.

SHORTEST TREND HISTORY / DURATION

This shows which group has the shortest amount of Flash memory allocated to its history record. Providing the archive period is less than the value displayed in the Duration window, no data will be lost from any group. If the archive period is greater than this value, then some of the data in one or more groups will have been overwritten and therefore lost.

If there is more than one group with the same Shortest Trend History Duration, the group with the lowest number is displayed. (E.G. If groups two and four both have the same duration, 'Group 2' will appear in this window.)

Note: Trend history duration depends on many factors, as described in Group Configuration (section 4.3.2). above.

4.3.5 ARCHIVE CONFIGURATION (Cont.)

CSV CHECKBOXES, DATE/TIME FORMAT

These appear only if the CSV option is fitted, and FTP File format is set to either 'CSV' or Binary and CSV'. Refer to the CSV option description below.

FTP FILE FORMAT

This configuration item appears only if the CSV option is fitted. Allows 'Binary' (.uhh) files, 'CSV' (.csv) files or 'Binary and CSV' to be chosen for FTP transfer. Please see the CVS option description below.

ARCHIVE TO REMOTE

| | |
|-----------|---|
| None | Archive is initiated by the operator (section 4.1) |
| Hourly | Archive occurs on the hour every hour |
| Daily | Archive occurs at 00:00* hrs each day |
| Weekly | Archive occurs at 00:00* hrs every Monday |
| Monthly | Archive occurs at 00:00* hrs on the 1st of each month |
| Automatic | The unit selects the slowest out of 'Hourly', Daily, Weekly or Monthly, which is guaranteed not to lose data (depends on the size of the Trend History Buffer). |

**Note: Archive times are not adjusted for Daylight Saving hour changes. Thus if the archive is set to 'daily', 'weekly' or 'monthly' then, during 'Summer Time', the archive will occur an hour late (i.e. at 01:00 hrs. instead of midnight).*

REMOTE PATH

The route to a folder or directory on the remote host, set up as a part of that host's FTP configuration

PRIMARY REMOTE HOST

If a Domain Name Server (DNS) is specified in the Network key 'Name' page ([fig 4.5.2](#)), then the Primary Remote Host is the server name. If DNS is not selected, then the Primary Remote Host is the IP address of the remote host, set up in the host's Control Panel\Network.

PRIMARY LOGIN NAME/PASSWORD

Login name and password of the remote host account assigned either by the Network administrator, or in the Guest account of the remote host's FTP Server or User Manager configuration. The password, which must be of between eight and 20 characters, must be entered twice to ensure integrity.

SECONDARY REMOTE HOST/LOGIN/PASSWORD

For Remote settings only:

As for primary versions, but for a secondary host. The secondary route is used only if the primary route fails.

4.3.5 ARCHIVE CONFIGURATION (Cont.)

CSV OPTION

This allows archive files to be transferred in Comma-separated-values (CSV) format to a PC via FTP.

The screenshot shows a configuration window for archiving data. The 'Archive to Remote' option is set to 'None', and the 'Ftp file format' is set to 'Binary and CSV'. Several checkboxes are checked, including 'CSV include Values', 'CSV include Messages', 'CSV include Header details', and 'CSV include Column headings'. The 'CSV Date/Time format' is set to 'Text'. The 'Remote path' is '/recorder/Group1'. The 'Primary remote host' is '0.0.0.0', the 'Primary login name' is 'anonymous', and the 'Primary password' is masked with asterisks. The 'Secondary remote host' is also '0.0.0.0', the 'Secondary login name' is 'anonymous', and the 'Secondary password' is masked with asterisks. At the bottom of the window are 'Apply' and 'Discard' buttons.

Figure 4.3.5b Archive menu items - CSV archive selected

FTP FILE FORMAT

This allows 'Binary', 'CSV' or both to be selected for file type when archiving. 'Binary' is the proprietary format used by the instrument and it requires other software (e.g. Review Software) to interpret the data, before it can be presented in spreadsheets, shown as if on a chart etc. Binary files have the extension '.uhh'.

CSV format is a standard open-file format for numeric data. A simple ASCII-based format, it is readable by a wide range of PC applications as well as being suitable for direct import into many commercial databases. CSV files have the extension '.csv'.

Note: CSV is ASCII based, and cannot interpret Unicode characters. Some characters available to the user will therefore be displayed incorrectly in CSV files.

If 'CSV' or 'Binary and CSV' is selected, a number of extra checkboxes appear. Figure 4.3.5b above shows a typical menu page. Figure 4.3.5c, below, shows the effects of enabling the CSV checkboxes, with the exception of 'CSV use Tab delimiter' the use of which is as follows:

4.3.5 ARCHIVE CONFIGURATION (Cont.)

CSV USE TAB DELIMITER

Despite its name, CSV does not always use commas as separators.

For example, in some countries, the decimal point is represented by a full stop (period), whilst in other areas, a comma is used. In order to avoid confusion between the comma as a decimal point and the comma as a separator, a different separator is used, usually the semicolon.

The instrument automatically chooses a separator suitable for use with the 'Locale' selected in System Configuration (section 4.6.2). 'CSV Use Tab delimiter' allows the user to override this choice, and force the instrument to use tabs as separators. This can be particularly useful when moving the data from one locale to another.

CSV DATE/TIME FORMAT

Allows 'Text' or Spreadsheet numeric to be selected. Text causes a time/date to appear in the spreadsheet. Spreadsheet numeric displays the number of days since December 30th 1899. The decimal part of the value represents the latest 6 hours, so DDD---DDD.25 represents 0600 hrs, DDD---DDD.5 represents noon etc. Numeric format is more easily interpretable by some spreadsheets, than Text format is.

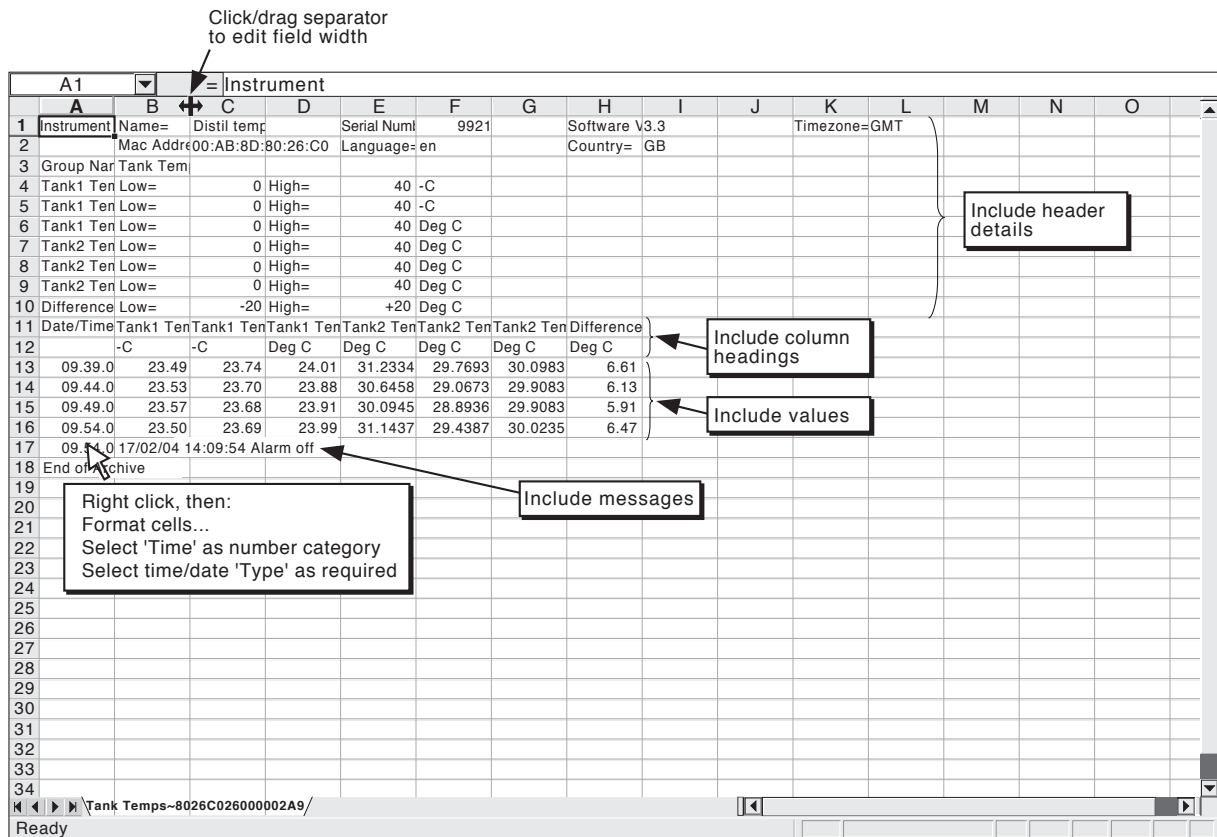

Figure 4.3.5c CSV data example

4.3.6 Event configuration

A number of internal and external (Event input option) triggers are available for use in initiating Events which will then run job lists. Events can have up to two sources each, but can themselves be used as sources allowing a large number of inputs to be used. Input sources can be logically combined, and can be inverted if required.

Event Number 1) Event 1 ▼ → Select Event 1 to 96

Source 1 Alarm on Group ▼ → Select source 1

On Group 1) Group 1 ▼ → Make source 1 sub selection (if any)

Source 2 Point Alarm ▼ → Select source 2

On Math 12 ▼ → Make source 2 sub selection (if any)

Alarm 2 ▼ → Make sub-sub selection (if any)

Source 1 Sense Source 1 ▼ → Select source inversion or not

Operator And ▼ → Select logic combination: Only, AND, OR, NAND, NOR, XOR.

Source 2 Sense Not Source 2 ▼ → Select source inversion or not

Descriptor Event 1

Job Number 1 ▼ → Select Job number

Category No Action ▼ → Select Job Category

Apply Discard

Figure 4.3.6 Event configuration menu layout

EVENT NUMBER

Allows the required event (1 to 96) to be selected for configuration.

SOURCE TYPES

| | |
|-----------------------|--|
| Off | The event is disabled |
| Global alarm | The event is active whilst any one or more alarms is active |
| Global Unack'd alarm | The event is active as long as there is an unacknowledged alarm present. |
| Comms channel timeout | The event is set if no communication has been made with 'Comms' channels within the Comms channel timeout period set in Instrument configuration (section 4.3.1). The source is reset when the next communication occurs. |
| Timer active | The event is triggered when a specified timer becomes active (section 6 of the Options manual). If the Timers option is not fitted, 'Timer Active' does not appear in the picklist. |
| Batch Running | The event is triggered when a batch is started and remains active until the batch stops. If Scope = 'Group' in Batch configuration (section 1.2 of the Options manual) then a group can be specified. If Scope = 'Instrument', the group select field does not appear. If the Batch option is not fitted, 'Batch running' does not appear in the picklist. |
| Batch Start | The event is triggered, fleetingly, when a batch is started. If Scope = 'Group' in Batch configuration (section 1.2 of the Options manual) then a group can be specified. If Scope = 'Instrument', the group select field does not appear. If the Batch option is not fitted, 'Batch Start' does not appear in the picklist. |
| Event | Allows another event to be specified as a source. |
| Point alarm | Triggered by the specified alarm on the specified point. |
| Unack'd point alarm | Triggered by the specified alarm on the specified point. Remains active until the alarm is acknowledged (section 3.1.3). |
| Alarm on Group | Triggered if any alarm in the specified group becomes active. |

4.3.6 EVENT CONFIGURATION (Cont.)

EVENT SOURCES (Cont.)

| | |
|-------------------------------|---|
| Unack'd Alarm on Group | Triggered if any alarm in the specified group becomes active. The event remains active until the alarm is acknowledged. |
| Instrument alarm | This source triggers an event if any of the following becomes active: Any, Input channel failure, FTP primary server failure, FTP secondary server failure, Maths channel failure, Clock failure, Recording failure - overflow, Network Boot failure, SNTP server failure, Time Synchronisation Failure, Battery backed RAM cleared. The event remains active until the instrument alarm clears. See section 3.1.3 for more details. |
| Power up | A transient event is triggered at power up. |
| Maths channel partial failure | For recorders fitted with the Maths pack option, this event is set if, say, one of the inputs to a group averaging function becomes invalid. In such a case, the average will be calculated on the remaining input values, but the result may not be as accurate as expected. Loss of one input can also be important in functions such as Fvalue, where several sensors may be distributed within the load and their outputs used in a group minimum calculation for input into the Fvalue equation. |
| Battery Low | This event is set when the battery is reaching the end of its useful life. The event remains active until the battery is replaced. |
| Invalid Password Entry | Transient event at the point of an invalid password entry attempt |
| User Login Account Disabled | Transient event at the point when an account is disabled because the number of password re-tries has been exceeded (Section 4.4.2). Not available if Auditor pack not fitted. |
| User Logged In | This event becomes active whenever a user with the specified Event Permission logs in. The event remains active until all local and remote users, with the specified permission, have logged out. See also section 4.4.1 (Access levels). |
| Event Button | Allows the operation of an event button (if User Screens option fitted) to be used as an event source. See section 4.3.7 for Event Button details. |
| Master Comms Slave Failure | If the Master Comms option is fitted, this event source allows either a communications failure with a specifiable remote device, or communications failure with 'Any' connected remote device to be used as an event source. See section 3 of the Communications Manual for more details. |
| Event input board | If one or more Event Input option boards are fitted, this allows a contact closure or negative going voltage signal to be used as an event source. The required input is defined by specifying a Board number and an Input number. Refer to 'Event Inputs' in the Options manual for more details. The menu item does not appear if Event input boards are not fitted. |
| Email failure | This event source appears only if the e-mail option is fitted (Options Manual section 11), and is triggered if an attempt to send an e-mail is unsuccessful |
| Batch Stop | The event is triggered, fleetingly, when a batch is stopped. If Scope = 'Group' in Batch configuration (section 1.2 of the Options manual) then a group can be specified. If Scope = 'Instrument', the group select field does not appear. If the Batch option is not fitted, 'Batch Stop' does not appear in the picklist. |

SOURCE 1 SENSE

Allows source 1 to be used in its normal sense (Select 'Source 1') or inverted (Select 'Not Source 1').

Example: Source 1 is alarm 1 on channel 3

With Source 1 Sense = Source 1, the event is active whenever channel 3 alarm 1 is active.

With Source 1 Sense = Not Source 1, the event is active whenever the alarm is not active.

4.3.6 EVENT CONFIGURATION (Cont.)

OPERATOR

This allows a logical combination of input sources to be used to trigger an event. The selections and their definitions are shown in table 4.3.6, below.

| Operator | Event active when: | Event not active when: |
|------------------------------|---------------------------|--|
| Only | S1 Active | S1 not active |
| AND | S1 and S2 both active | S1 and/or S2 not active |
| OR | S1 and/or S2 active | S1 and S2 both not active |
| NAND | S1 and/or S2 not active | S1 and S2 both active |
| NOR | S1 and S2 both not active | S1 and/or S2 both active |
| XOR | S1 or S2 active | S1 and S2 both active or both not active |
| S1 = Source 1; S2 = Source 2 | | |

Table 4.3.6 Logical operators for event sources

SOURCE 2 SENSE

Allows source 2 to be used in its normal sense (Select 'Source 2') or inverted (Select 'Not Source 2').

Example: Source 2 is Group 1 Batch Running

With Source 2 Sense = Source 2, the event is active whilst the batch is running.

With Source 2 Sense = Not Source 2, the event is active whilst the batch is not running.

DESCRIPTOR

Allows a text string to be entered as the event title. See [section 3.3.1](#) for text entry techniques.

JOB NUMBER

Select a job number for this event.

CATEGORY

Select the required job to be carried out when the channel is in alarm (e.g. Drive relay) See [section 4.7](#) for a description of job categories.

WHILE/ON

Allows the action of the alarm job to be chosen as

- whilst active, whilst inactive or whilst unacknowledged for continuous jobs (e.g. drive relay), or,
- on going active, on going inactive or on acknowledgement for 'one-shot' jobs (e.g. increment counter).

See also [figure 4.3.3g](#) and associated text.

EVENT EXAMPLE

An event is to be active whenever Channel 1 Alarm 1 is active whilst Channel 3 alarm 2 is not active.

Source 1 = Point alarm (On = Channel 1; Alarm = 1)

Source 2 = Point alarm (On = Channel 3; Alarm = 2)

Source 1 Sense = Source 1

Operator = And

Source 2 Sense = Not Source 2

It is possible to achieve the same result by inverting both Source senses and using the Nor operator.

4.3.7 Event Buttons

This configuration item appears only if the User Screens Option is fitted. With this software version, the only places at which buttons can be displayed and operated is in User Screens.

The Event Button configuration menu allows a number of 'Push-Buttons' to be set up for use as event sources. Buttons can be defined as 'Unlatched' (push = on; release = off) or 'Latched' (push once = on; push again = off etc.).

Note: momentary button action occurs when the button is released.

Momentary types have a single text string associated with them. Latching types have two text strings, one for the 'On' (latched) state; the other for the 'Off' state. Figure 4.3.7 shows the configuration menu.

Event buttons are independent of the Security Management option, described in section 4.4.2. This allows individual buttons to be a) entirely open to the user, b) to require signing, or c) to require both signing and authorization, as required.

For further details see the User Screens description in section 2 of the Options Manual.

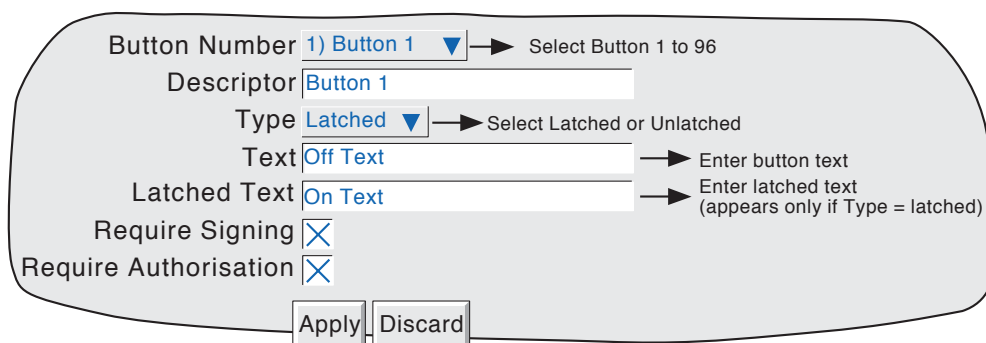

Figure 4.3.7 Event Button option configuration menu

| | |
|-----------------------|--|
| Button number | Allows selection of the button to be configured. |
| Descriptor | Allows a button name, of up to 20 characters, to be entered. |
| Type | Select Latched or Unlatched, as defined above. |
| Text | For unlatched buttons, this allows entry of the legend which is to appear on the button when displayed. For latched buttons, this is the legend which appears when the button is in its non-active (off) state. |
| Latched Text | This field appears only if Type = Latched, and allows entry of the legend which is to appear on the button when in its active (on) state. |
| Require Signing | If this field is enabled, then the button can be used only by those whose 'Can Sign' permission is enabled in the 'Access' menu described in section 4.4.1 above. When the button is operated in the User screen, a 'signature' page appears which requires the entry of the correct password for the selected user, and of a note which would normally be used to give the reason for the operation. |
| Require Authorisation | This field appears only if 'Require Signing' is enabled. If Require Authorisation is enabled, then the button can be used only by those whose 'Can Authorize' permission is enabled in the 'Access' menu described in section 4.4.1 above. When button operation is attempted, a 'signature' page (figure 4.4.2b) appears which requires the entry of the correct password for the selected user, and a note which would normally be used to give the reason for the change. |

Notes:

- 1 'Require Signing' and 'Require Autorisation' appear only if the Auditor pack option is fitted.
2. If the Auditor pack option is fitted, a message appears on the chart after authorization and/or signing are complete. The example below shows the message when both Signing and Authorisation are enabled.
DD/MM/YY HH:MM:SS Button Descriptor,Signed:Engineer,Authorised:Engineer,Note

4.3.8 Messages

This feature allows messages to be sent, by job action (section 4.7), to the display, to a specified group or to all groups. Messages can also be included in e-mails (Options manual, section 11) if the relevant option is fitted. The messages are of the form: Date, Time, Message. The message can be just text (up to 80 characters), or it can include up to nine embedded items which are typed into the message as {1} to {9}. The embedded values represented by {1} to {9} are selected from picklists.

If a Group-destination message contains more characters than can be displayed on the screen the right-hand part of the message is invisible to the user. The message appears in full in the [message log](#) and when Review Software is used. Display-destination messages are always fully visible.

MESSAGE ENTRY

The message configuration page is shown below in figure 4.3.8 The page is accessed from the Root menu/Operator/Config menu.

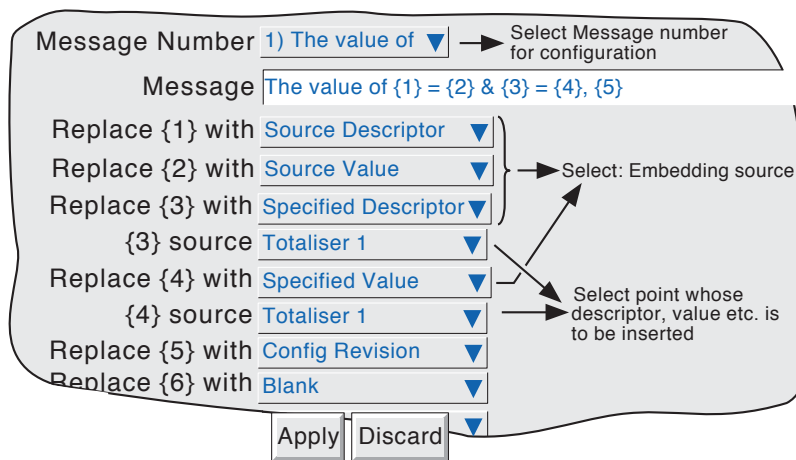

Figure 4.3.8 Message entry configuration page.

CONFIGURABLE PARAMETERS

- Message Number Select the required message from the picklist.
- Message Enter the message by using the pop-up keyboards (section 3.1.1)
- Replace {n} with A picklist allowing the user to select data to be embedded in the message:
 Source Descriptor: The descriptor of the source which triggers the job message.
 Source Value: The instantaneous value of the source at trigger time.
 Source Alarm Data: Details (see table 4.3.8) of the source alarm at message trigger time.

| Alarm Type | Embedded details |
|----------------|--|
| Absolute | Enable, Type (high or low), Threshold, Status |
| Deviation | Enable, Type (in or out), Reference, Deviation, Status |
| Rate of change | Enable, Type (rise or fall), Amount, Change time, Status |

Table 4.3.8 Alarm details versus alarm type

Note: If any of 'Source Descriptor', 'Source Value' or 'Source Alarm Data' are embedded in a message which is triggered by a job which cannot be associated with a specific source (e.g. event, timer), then the embedded value will be: ?????.

(Continued)

4.3.8 MESSAGES (Cont.)

Replace {n} with (Cont.)

Specified Descriptor, Specified Value, Specified Alarm data: Produces a further field '{n} source', described below.

Batch Status: Causes the status ('Active' or 'Inactive') of the current batch to be embedded. See Section 1 of the Options manual for Batch details.

Batch Field data: Allows a selected batch field to be included in the message. If a batch is not running at the time the message is triggered, the Batch field data is replaced by '?????'. See Section 1 of the Options manual for Batch details.

Note: Group number must be entered if the batch is configured for Group mode.

Instrument Name: Allows the Instrument Name (as entered in Configuration/Instrument - section 4.3.1) to be included in the message.

Instrument Number: Causes the instrument number (Network/Address - Section 4.5.1) to be embedded.

Config Revision: Embeds the Config File Version number (System/About - section 4.6.5) in the message

{n} source

This field appears only if the previous field (Replace {n} with) is selected as 'Specified Descriptor', 'Specified Value' or 'Specified alarm data'. The associated picklist(s) allow a specific point, and a specific alarm (if appropriate) to be selected. It is thus possible to configure, say alarm 1 on channel 2, to produce a message giving the descriptor and/or value of, say, totaliser 1.

Notes:

1. n = 1 to 9
 2. The example below is intended to clarify message entry techniques.
-

4.3.8 MESSAGES (Cont.)

EXAMPLE

To configure Message 2 to read "The value of Chan two = (*Value channel 2*) & Tot one = (*Value totaliser 1*)"

Before configuring the message:

In channel configuration:

Set channel 2 descriptor to: Chan two

Set Channel 2 alarm job to:

Category: Message

Send message(s) to: All Groups

First message: 2) Message 2

Last Message: 2) Message 2

On: Active

In Totaliser configuration:

Set Totaliser 1 descriptor to: Tot one

In Messages configuration:

1. Select Message 2.
2. Access the Symbols keyboard (section 3.3.1) and enter, without spaces, {}={}&{}={}
3. Access the Numeric keyboard and insert 1, 2, 3, 4 within the braces to give: {1}={2}&{3}={4}
4. Access the Alphabet keyboard, and insert text and spaces: The value of {1} = {2} & {3} = {4}
5. Set 'Replace {1}' to 'Source Descriptor'
6. Set 'Replace {2}' to 'Source Value'
7. Set 'Replace {3}' to 'Specified Descriptor'
8. Set '{3} source' to Tot one
9. Set 'Replace {4}' to 'Specified Value'
10. Set '{4} source' to 'Tot one'

The result of this is that, should the channel 2 alarm go active, the following message would be sent to all groups, appear on the 'chart' and become part of all groups' histories:

```
18/10/01 11:19:58 The value of Chan two = 6.0°C & Tot one = 3383.8073 Units
```

Note: On some models, the message may be wider than the screen. If necessary, the message can be shortened (e.g. use 'Ch2' instead of 'Chan two'), or it can be viewed in full, either in [Message log](#), (section 3.2.1) or by using [Review Software](#), if available.

4.3.9 User Linearisation Tables

The Channel configuration item 'Lin Type' includes four linearisation tables called, initially, UserLin1 to UserLin4. This User Linearisation part of the instrument configuration allows the user to enter a linearisation look-up table of between two and 66 pairs of points.

The pairs of points are entered as X1Y1, X2Y2... ..XnYn,

where 'n' is the specified number of points.

X1 to Xn represent the inputs to the function.

Y1 to Yn represent the corresponding outputs from the function.

Notes:

1. Each Y value must be unique - i.e. there cannot be more than one X value with the same Y value assigned to it.
2. Each X value (other than the first) must be greater than the previous one.
3. Each Y value (other than the first) must be greater than the previous one.
4. To specify units other than temperature units, the channel 'scale' facility must be used. The scale low/high values should be set to be the same as the range low/high values, and the required units entered.

The import/export Linearisation tables feature described in 'Save/Restore' ([section 4.2.7](#)) offers an alternative way of entering linearisation tables.

Figure 4.3.9a shows the default configuration page. Figure 4.3.9b shows a simple table for relating water depth to water volume for a cylindrical tank with a conical bottom.

Figure 4.3.9a User linearisation configuration page

CONFIGURATION PARAMETERS

| | |
|--------------------|---|
| User Linearisation | Allows one of the four user linearisation tables to be selected for configuration. |
| Descriptor | Allows the user to enter a name of up to 20 characters (including spaces) for the table. |
| Format | This allows the point pair values to be entered as normal numeric values (Numeric) or in 'Scientific' format (Scientific). When 'Scientific' is selected, values are displayed and entered as a decimal number between 1 and 10 [†] (the mantissa), followed by a multiplier (the exponent). E.G. to enter a value of 1244.5678, the value entered would be 1.2445678E3, where 3 represents the number of places that the decimal point must be shifted <u>to the left</u> in order to convert the value to a number between 1 and 10 [†] . To enter a value of 0.0004196, the entry would be 4.196E-4. Figure 4.3.9b, below, gives further examples. |

† Notes

1. Strictly this is a number less than 10, as 10 would be 1.0E1.
2. There must be at least one number after the decimal point.

4.3.9 USER LINEARISATION TABLES (Cont.)

CONFIGURATION PARAMETERS (Cont.)

- Number of points This is used to enter the total number of point pairs in the table. The following XY fields increase in number up to the entered value. (A scroll bar appears if there are more points than can be displayed in the available screen height.)
- X1 to XN The input values to the table, where N is the 'Number of Points' entered above.
- Y1 to YN The resulting, corresponding output values from the look-up table.

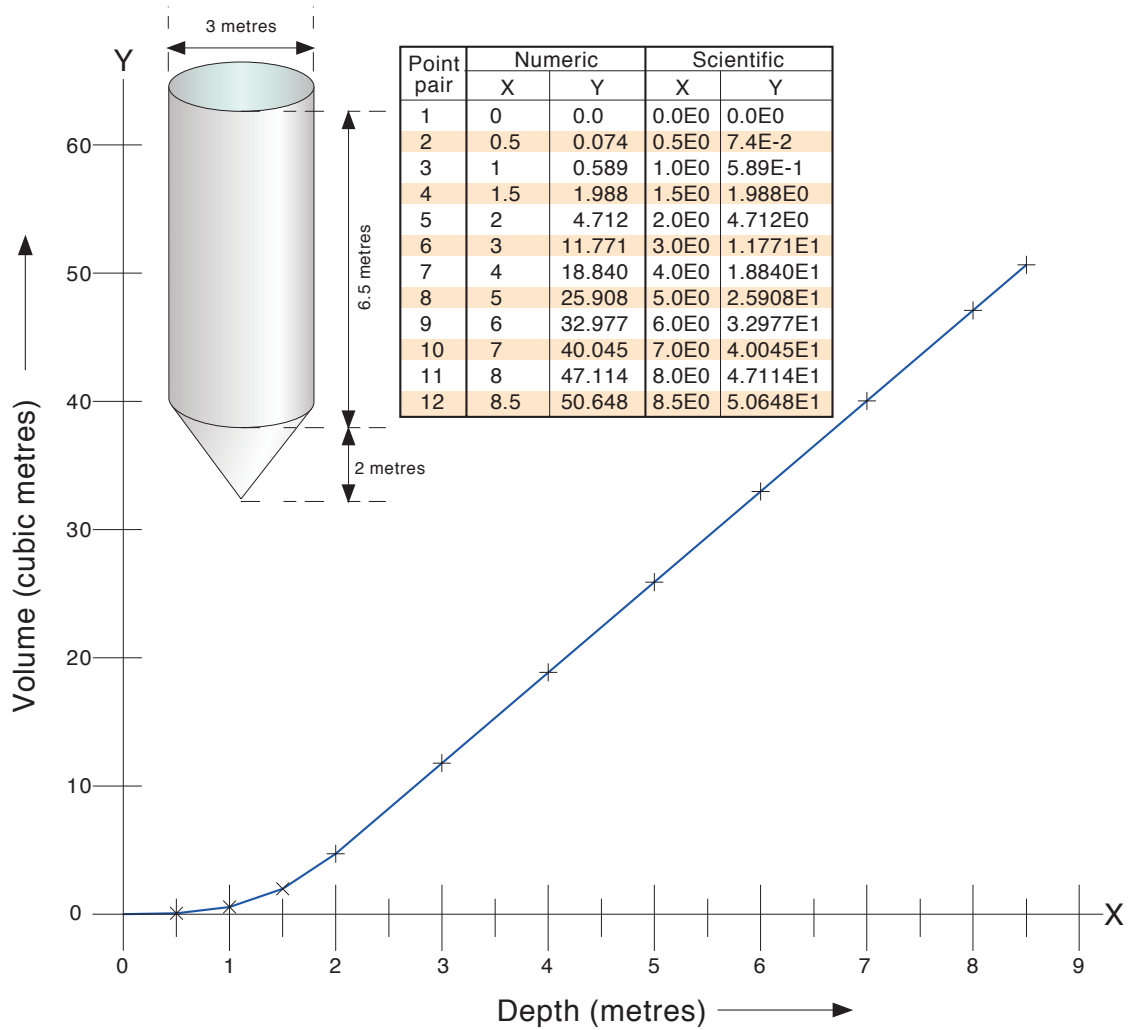

Figure 4.3.9b Sample User Linearisation table

4.3.10 Options

The Options menu layout is displayed within a rounded rectangular frame. It contains a list of settings, each with a dropdown menu showing its current value. At the bottom of the frame are three buttons: 'Apply', 'Discard', and 'Autoconfigure'.

| | |
|------------------------|-----------------|
| Fitted channels | 6 |
| Events | 96 |
| Event Buttons | 96 |
| Totalisers | 6 |
| Counters | 6 |
| Timers | 6 |
| Maths | 72 |
| Groups | 6 |
| Alarms per | 4 |
| Batch | Enabled |
| Circular Trend | Enabled |
| Auditor Pack | Enabled |
| Security Manager | Enabled |
| Remove Viewer level | Full |
| Remote Viewers | 4 |
| Screen Builder | Full |
| File transfer protocol | 4 |
| Modbus/TCP clients | 2 |
| Messages | 24 |
| Serial Comms | Enabled |
| Adaptive Recording | Enabled |
| User Linearisations | 4 |
| Logarithmic Scales | Enabled |
| Master Comms Slaves | 16 |
| Output Channels | 48 |
| Demand Writes | 48 |
| Emails | 12 |
| Reports | 10 |
| Archive CSV | Enabled |
| Relay Boards | 1 |
| Relays on board 1 | 1 |
| Event Input Boards | 1 (currently 0) |

Buttons: Apply, Discard, Autoconfigure

Figure 4.3.10 Options menu layout

Clicking on this key calls a display showing the current unit's hardware/software setup, for example the number of input channels fitted, the number of output relay boards fitted, and how many relays are fitted per card. Subsequently, should further options be fitted (relay board three in the above example), this page shows the difference between the hardware actually fitted and the hardware which the software is configured for (currently ...). Whenever there is a difference, the 'Autoconfigure' key can be clicked-on to alert the instrument to the fact that extra options have been added (or taken away). If no changes have occurred since last switch-on, then the '(currently ...)' fields and the 'Autoconfigure' key do not appear.

4.4 SECURITY

Clicking on this key allows the operator to select 'Login' (described in section 3.3.1) 'Access' 'Management' or 'Add/Remove User' for configuration.

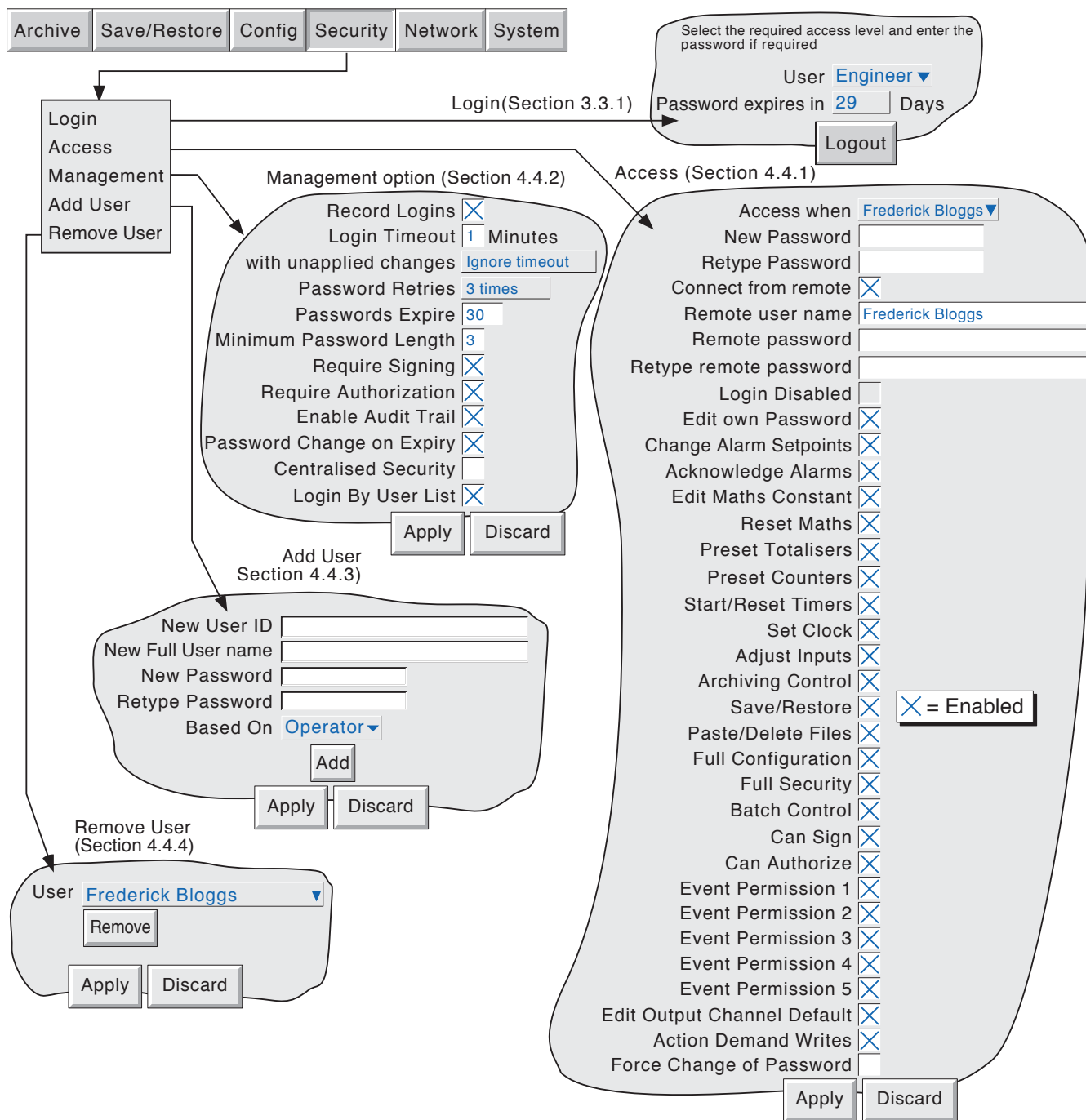

Figure 4.4 Security configuration menus

4.4.1 Access levels

There are essentially three levels of security, viz: Engineer, Operator and Logged out. (The fourth level - Service - is available only to service engineers). When logged-in at engineer level, the user can set access permissions for other levels, and can enter or edit passwords for Operator and Engineer levels. For instruments with the Auditor Pack Option enabled and software version 3.1 or higher, the default passwords for Engineer and Operator level access are both '100'. Otherwise, the default password for Engineer level is set to 10 and the default password for operator level is 'blank'

Note: To allow free access to the configuration menus, the password can be set to 'blank'. This allows subsequent access without a password having to be entered (not for units with the Audit Pack option).

Users with Full Security permission can Add (and Remove) users (sections 4.4.3, 4.4.4) and assign them individual passwords and access permissions.

SETTING PERMISSIONS

Once logged in at Engineer level, operate the SECURITY key and select Access. A page similar to that shown in figure 4.4.1 appears, allowing permissions to be set for the various access levels and for individual users. The list of parameters is the same for all access levels except for 'Logged out', for which the password parameters and 'login disabled' items do not appear.

Note: If the Security management option is fitted, and 'Centralised Security' is enabled in the Security/Management system (section 4.4.2), permissions are 'Read Only' (i.e, not editable) at the operator interface. In such a case permissions can be changed only by using the Security Management software.

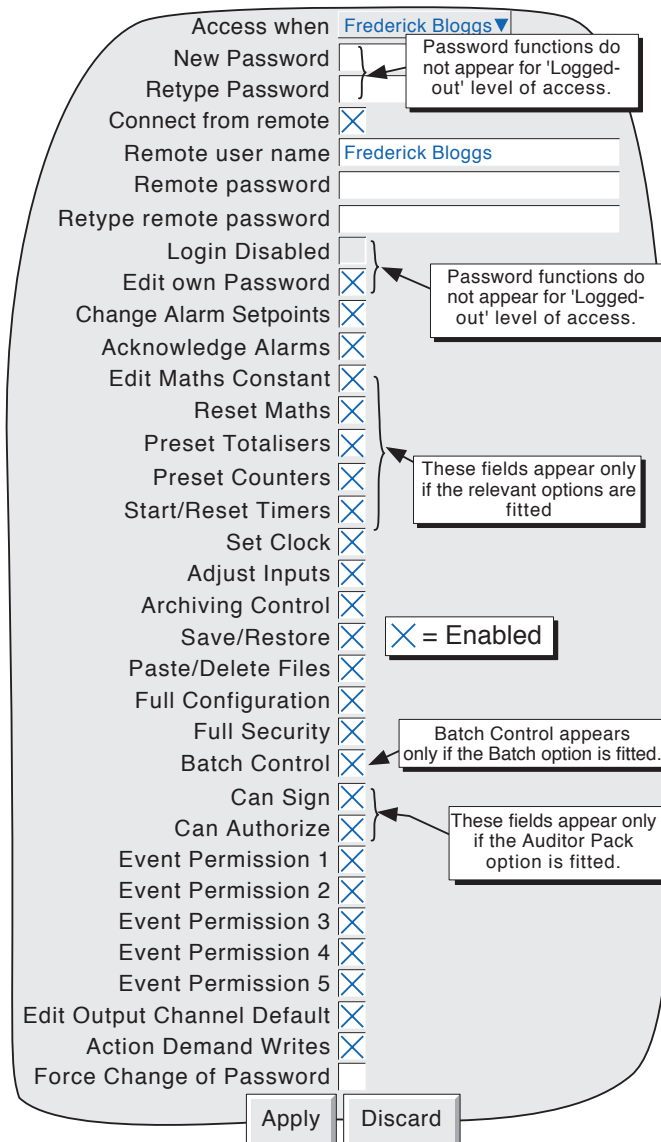

Figure 4.4.1 Access permissions menu

4.4.1 ACCESS LEVELS (Cont.)

ACCESS WHEN:

Allows an access level or an individual user ID to be selected from a pick list.

NEW PASSWORD/RETYPE PASSWORD

For all levels except Logged Out, these fields allow a new password to be entered for the selected access level or User. The password must be entered in the 'Re-type Password' field. If the two differ, a warning message (Passwords did not match) appears when the APPLY key is operated, and password entry must be repeated. If the password does not comply with the minimum length requirements in Security Management (if fitted) ([section 4.4.2](#)), a warning message (Invalid Password) appears when the 'Apply' key is operated, and password entry must be repeated.

CONNECT FROM REMOTE

This field is always enabled for all access levels other than 'Logged out'.

REMOTE USER NAME/PASSWORD

For all levels except Logged Out, these two entry boxes allow user name and password to be entered for use by the remote host operator. The remote user will be able to access the unit's configuration according to the other access permissions enabled in this page. The password must be entered twice to ensure integrity.

Notes:

1. Remote login will be refused if the user account is disabled for any reason.
 2. For maximum security, it is recommended that the remote password and the 'local' password are non-identical.
-

LOGIN DISABLED

For all levels except Logged Out, this allows any one or more of the access levels do be removed from the 'Access when' picklist.

Note: This feature should be used with discretion, or the situation might arise in which the unit cannot be logged onto, either at a particular access level or at all. It is recommended that at least one user with Engineer-level access is retained with login enabled, or it may become necessary to carry out the 'Lockout Recovery procedure described in [section 2.4](#)

Auditor pack notes:

- 1 If the Auditor Pack option is fitted, and the number of Password Retries is exceeded the relevant login is disabled. A user with Engineer level access can re-enable the login.
 2. If the Auditor Pack option is fitted, and the Password Expire time has been exceeded, all logins are disabled. In order to reconfigure the unit, it is necessary to carry out the 'Lockout Recovery procedure described in [section 2.4](#)
-

EDIT OWN PASSWORD

For all levels except Logged Out, allows each user, with this permission enabled, to edit his/her password.

CHANGE ALARM SETPOINTS

Allows each user with this permission enabled, to edit alarm parameters under Configuration/Channel.

ACKNOWLEDGE ALARMS

Allows each user with this permission enabled, to acknowledge alarms ([section 3.1.3](#)).

EDIT MATHS CONSTANT

For units fitted with the Maths option only. If one or more maths channels are configured with function 'Constant', then with this permission set, the user may edit the constant value(s).

4.4.1 ACCESS LEVELS (Cont.)

RESET MATHS

Allows the user to reset applicable maths function either directly from the maths channel configuration page or by setting a maths job.

PRESET TOTALISERS

Allows the user to preset totaliser values (if the option is fitted) either directly from the configuration page or by setting a totaliser job. See Section 4 of the Options manual for further details of totalisers.

PRESET COUNTERS

Allows the user to preset counter values (if the option is fitted) either directly, from the configuration page, or by setting a counter job. See Section 5 of the Options manual for further details of counters.

START/RESET TIMERS

Allows the user to start and reset the timer (if the option is fitted) either directly from the configuration page or by setting a timer job. See Section 6 of the Options manual for further details of timers.

SET CLOCK

Allows each user with this permission enabled, to set the time and date functions under System/Clock

ADJUST INPUTS

Allows the user to adjust process values as described in [section 4.6.4](#).

ARCHIVING CONTROL

Allows each user with this permission enabled full access to archive control.

SAVE/RESTORE

Allows each user with this permission enabled, full access to saving and restoring functions as described in [section 4.2](#), above. Without this permission, the SAVE/RESTORE key does not appear.

FULL CONFIGURATION

Allows each user with this permission enabled, full access to configuration.

FULL SECURITY

Allows each user with this permission enabled, full access to all the units security functions.

BATCH CONTROL

This field appears only if the Batch Option is fitted - Refer to Section 1 of the Options manual for further details.

CAN SIGN

This appears only if the Auditor Pack option is fitted. If the field is enabled it allows the user to change the configuration of the unit (according to the other permissions set for the login), providing the security management system 'Require Authorization' is not enabled. If it is, changes can only be made if the correct password for a user with 'Can Authorize' permission is entered. See [section 4.4.2](#) for details

4.4.1 ACCESS LEVELS (Cont.)

CAN AUTHORIZE

This appears only if the Auditor Pack option is fitted. If the field is enabled it allows the user to change the configuration of the unit according to the permissions set for the login. See [section 4.4.2](#) for details of the Auditor pack (Security Management) option.

EVENT PERMISSION 1

If this is enabled, then this login will trigger an event source which remains active for as long as the login is active. See [section 4.3.6](#) (Event Sources: User Logged In) for further details.

EVENT PERMISSION 2 TO 5

As for Event permission 1, above.

EDIT OUTPUT CHANNEL DEFAULTS

Appears only if the Master Comms option is fitted. Master comms is described in section 3 of the Communications Manual.

When enabled, this allows a user with this login to edit the default value of any output channel. Normally the defaults are used only when the source channel is 'In Error'.

ACTION DEMAND WRITES

Appears only if the Master Comms option is fitted. Master comms is described in section 3 of the Communications Manual.

When enabled, this allows a user with this login to write values manually over master comms either directly, by job action or (if the option is fitted), by using the User Screens 'Operator' key. Where Demand Writes are initiated by Job action, the job will be carried out whether or not this login has permission to action Demand Writes.

Note:

When Audit trail is enabled, only the newly written value appears in the audit trail messages. This is because the instrument has no way of determining what the value of the parameter was before the write occurred.

The messages are of the form:

12/06/03 10:14:30 Auto Mode wrote 19.37

12/06/03 10:14:29 Demand write Auto Mode, Signed Engineer, No Auth. Reqd., Note

where 'Auto Mode' is the descriptor associated with the demand write, and '19.37' is the value written.

FORCE CHANGE OF PASSWORD

When this checkbox is enabled for a user, it means that that user will have to change password at his/her next login. At next log in, a pop-up dialogue box requests that a new password be entered. If a new password is not entered, login is denied.

Entering the new password clears the checkbox, so this is a 'one-shot' operation, until the checkbox is enabled again by a user with 'Engineer' level access.

The image shows a 'Change Password' dialog box. It has a title bar with the text 'Change Password'. Below the title bar, there are two text input fields. The first is labeled 'New Password' and the second is labeled 'Retype Password'. Below these fields, there are two buttons: 'Apply' and 'Logout'.

4.4.2 Management (option)

This menu selection appears only if the Auditor Pack option has been fitted.

This option allows the instrument to be set up so that all changes to configuration (with the exceptions listed below) are added to the history files and also allows certain constraints to be placed on the unit's passwords. Once these items of configuration are set up, they apply to all groups. Figure 4.4.2a, below, shows the configuration menu.

CHANGES NOT RECORDED

Changes to configuration made via MODBUS/TCP are not recorded. It is up to the user to write the identity, time/date, reason for change etc. as text messages, which when sent via MODBUS/TCP, become part of the relevant history file.

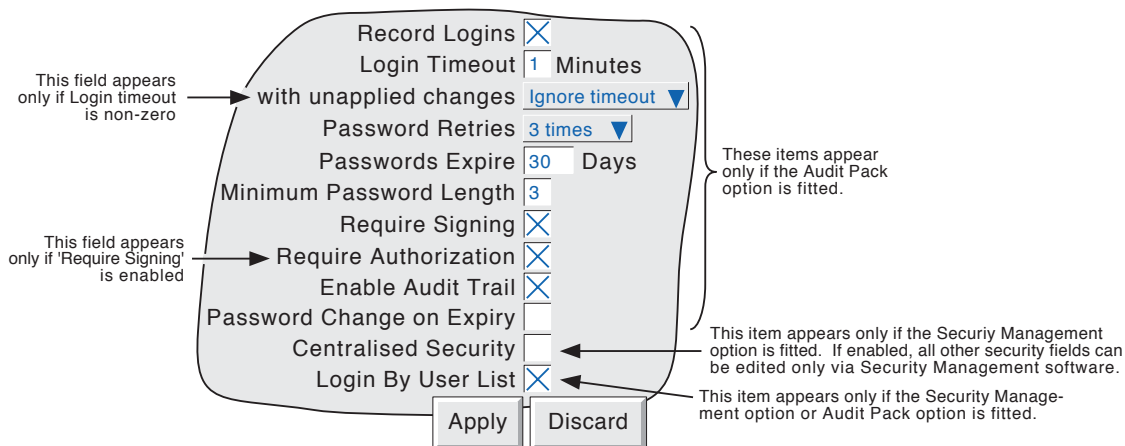

Figure 4.4.2a Management menu structure

CONFIGURABLE PARAMETERS

Notes:

1. Unless otherwise indicated, the following parameters appear only if the Auditor Pack option is fitted.
2. If 'Centralised Security' is enabled, none of the other parameters in this menu can be edited at the operator interface. Changes can be made only using Security Management software.

| | |
|------------------------|--|
| Record logins | If this field is enabled (cross appears), then each time a new login occurs a message appears on the chart, giving the date, time, MAC address of the remote viewing device and login name. For example: 30/04/02 16:33:30 Login by (149.121.130.126)Frederick Bloggs. Logouts are recorded in a similar way -e.g: 30/04/02 16:43:19 Logout by (149.121.130.126)Frederick Bloggs. |
| Login Timeout | When set to zero, the login remains valid until changed. For any other value, the user is logged out after the number of minutes entered here has elapsed since the last operation. |
| with unapplied changes | This field does not appear if the Login Timeout has been set to zero. for non-zero time-out values, this allows the user to choose whether a. any unapplied changes are lost when the Login Timeout period has elapsed, or b. the login timeout is ignored if there are any unapplied configuration changes. |

4.4.2 MANAGEMENT (Cont.)

CONFIGURABLE PARAMETERS (Cont.)

Password Retries This allows the user to set the number of retries allowed after a failed attempt to enter a password. The choices are '3 times' and 'unlimited'. When set to 3 times, the user login is disabled after four incorrect attempts to enter the password have been made. A 'System Message' appears on the screen and is also sent to the 'chart':
19/12/01 09:14:24 User Frederick Bloggs, login disabled, invalid password
In order to re-enable the login, a user with Engineer access level must deselect 'Login Disable' in the 'Access' menu described in section 4.4.1, above.

Passwords expire This field allows the user to set an expiry period of up to 999 days which applies to all passwords. The number of days remaining to expiry is shown in the login page. If set to zero, then the expiry period does not apply.

Note: All required passwords MUST be changed within this number of days or all logins will be disabled. It will then be necessary to carry out the 'Lockout Recovery procedure described in section 2.4. (But see 'Password Change on Expiry', below).

Mimimum Password Length This allows a minimum length of password to be entered. If an attempt is made to enter a new password with fewer characters than the minimum, a warning message appears on the screen (Invalid Password Length) and the new password is ignored. For units with the Auditor Pack option fitted, the minimum password length cannot be set to less than 3

Require Signing If this field is enabled, then changes to the unit's operation, configuration (or any other item included in the history file) can be made only by those users whose 'Can Sign' permission is enabled in the 'Access' menu described in section 4.4.1 above. When 'Apply' is attempted, a 'signature' page appears which requires the entry of the correct password for the selected user, and of a note which would normally be used to give the reason for the change.

Require Authorization This field appears only if 'Require Signing' is enabled. If Require Authorization is enabled, then changes to the unit's operation, configuration (or any other item included in the history file) can be made only by those users whose 'Can Authorize' permission is enabled in the 'Access' menu described in section 4.4.1 above. When 'Apply' is attempted, a 'signature' page (figure 4.4.2b) appears which requires the entry of the correct password for the selected user, and a note which would normally be used to give the reason for the change.

Note: If neither 'Require Signing' nor 'Require Authorization' is enabled, then any user can make changes to the unit's operation, configuration etc. and the 'signature' page does not appear.

4.4.2 MANAGEMENT (Cont.)

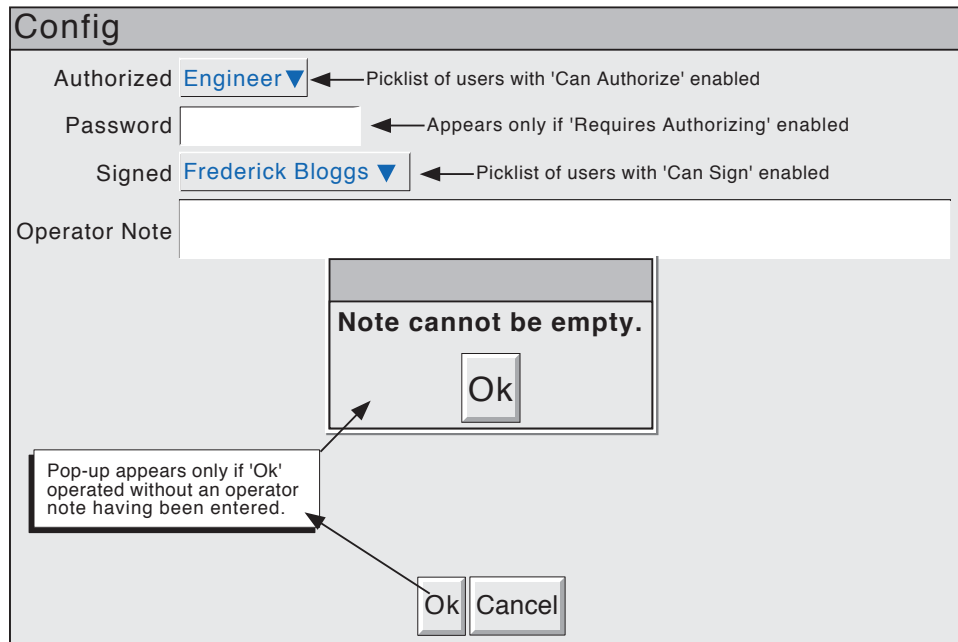

Figure 4.4.2b Signature page

Enable Audit trail

If this field is enabled, then all changes to configuration are displayed on the 'chart' and become part of the history file for each enabled group. The following is an example of how these changes would appear on the screen for an imaginary set up for channel 8. 'New T/C type chan 8' is the note entered in the Signature page, and 'Kiln8 temp' is the channel descriptor.

```

19/10/03 11:53:01 Configuration revision 486,144 was 486,143
19/10/03 11:52:57 Kiln8 temp Alarm Number 1, Job Number 1 Drive Relay 1 on board 7 while Unacknowledged was No action
19/10/03 11:52:57 Kiln8 temp Alarm Number 1 Threshold 530.0 °C was 500
19/10/03 11:52:57 Kiln8 temp Alarm Number 1 Type Absolute Low was Absolute High
19/10/03 11:52:57 Kiln8 temp Cold Junction Type Internal was External
19/10/03 11:52:57 Kiln8 temp Scale High 1000.0°C was 900.0
19/10/03 11:52:57 Kiln8 temp Scale Low 450.0°C was 300.0
19/10/03 11:52:57 Kiln8 temp Lin Type Type K was Type J
19/10/03 11:52:57 Config,Signed:Engineer,Authorized:Engineer,New T/C type chan 8

```

Notes:

1. The Configuration revision (and for changes in the Security menus - the Security revision) are incremented every time the instrument's configuration (security configuration) is changed, The current values can be viewed in the System/About menu (section 4.6.5).
2. All configuration and security changes must be made using the Remote Viewer. Use of the configuration editor is not permitted if traceability is to be maintained.
3. If fitted, Event buttons (section 4.3.7) are not included in the Require Signing/Require Authorization regime described above. Instead, each individual button can be configured to require signing or to require signing and authorization.

4.4.2 MANAGEMENT (Cont.)

Password Change on Expiry If this check-box is enabled, then the first time a user tries to login, after his or her password has expired, a dialogue box appears asking the user to enter a new password. Only when this new password has been entered and confirmed, will the user be able to access configuration menus.

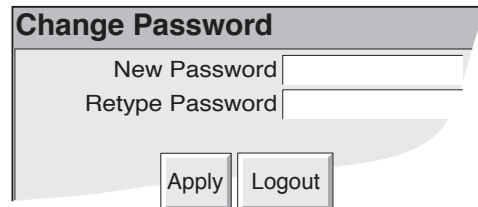

Security Management Option. The new password is not written to the Security Manager until the next 'deploy', after which the expiry period configured for the user (within Security Management), is restored. The interim expiry period is set to 24 hours, and the 'deploy' must be carried out within this period, or password expiry will recur.

Centralised Security

This checkbox occurs only if the Security Management option is fitted. If this checkbox is enabled, none of the other parameters in the Management menu can be edited at the user interface (i.e they become 'Read Only'). Changes can be made only by means of Security Management software. The following menu items also become 'read only', do not appear as menu items or are not selectable, even if the checkbox appears:

- Access level permissions (section 4.1.1) (Read Only)
- Add User/ Remove User (section 4.4.3) (Do not appear as menu items)
- Restore configuration/Security data (section 4.2.2) (Not selectable)
- New configuration/Security data (section 4.2.3) (Not selectable)

The Security Revision (previously Security Version) is initially set to -1 when Centralised Security is enabled. It will remain at this value until a successful download has been performed via Security Manager Software. The Security Revision will then take the downloaded value (e.g. 139). Any local security revision changes (e.g. max. number of logins exceeded) cause the value to have a 'local change count', starting at 001 appended to it (e.g. 139.001, 139.002 and so on). The local change count is reset to 000 (and no longer displayed) when the next download occurs (e.g 140). Downloads can be set to occur automatically when the Security Manager detects that a local change has occurred, or can be initiated manually, as and when required.

Login by User List

This checkbox appears if either or both of the Audit pack and Security Management options are fitted. When enabled, the normal login window appears, with a pull down list of users. Once a user has been selected the correct password for that user must be entered in order to log in. When disabled, the user must enter a User ID and associated password in order to log in.

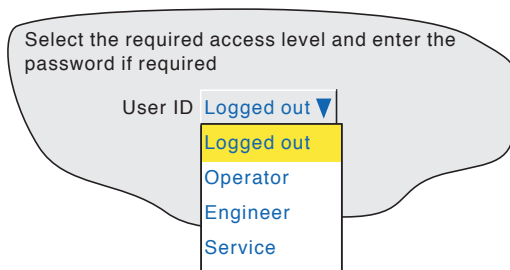

'Login By User List' enabled

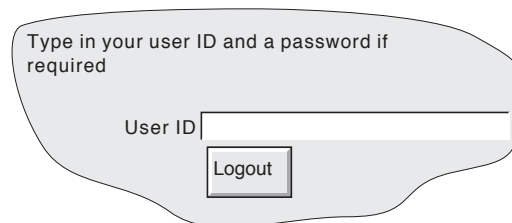

Login By User List' not enabled

4.4.3 Add user

Figure 4.4.3 shows that the selecting of 'Add User' from the SECURITY picklist allows new user IDs to be entered, together with passwords, and a chosen set of access permissions, which can subsequently be edited under Security/Access. The ADD key and the APPLY key must both be used to write the change to the instrument's data base. The user must have Full Security access in order to add a new user. If the Auditor pack option is fitted, the new user's access permission list is printed on the chart.

NEW USER ID

This field allows a User ID of up to 20 characters to be entered for a new user. This ID is used when logging in using ID/password entry technique (that is, when 'Login by user list' is disabled, as described above).

NEW FULL USER NAME

This field allows a User name of up to 25 characters to be entered. This name is used by the Security Management option, appears in the 'current access level' pushbutton at the top left corner of the display screen, in operator notes and so on.

NEW PASSWORD/RETYPE PASSWORD

These fields allow a password to be entered and confirmed. If the password does not comply with the minimum length requirements in Security Management (if fitted) (section 4.4.2), a warning message (Invalid Password) appears when the 'Apply' key is operated, and password entry must be repeated.

BASED ON

This picklist allows another user or access level to be used as a permissions template, to simplify the configuration if several operators are to have identical permissions.

Figure 4.4.3 Add User display page

4.4.4 Remove user

Selecting 'Remove User' from the SECURITY picklist allows users to be removed from the user list. The 'Remove' key and the 'Apply' key must both be used to write the change to the instrument's data base. Figure 4.4.4 depicts the display page. The User Full Name appears in this page.

Figure 4.4.4 Remove User display page

4.5 NETWORK KEY

Note: This manual does not describe network setup in detail, because each network is different. In most cases, the help of the Network Administrator or Supervisor will be required, for example, in the allocation of valid addresses and passwords.

Operating the Network key calls a selection box to the display, allowing 'Address' or 'Name' to be selected for configuration.

4.5.1 Address

Figure 4.5.1 shows the address menu fields.

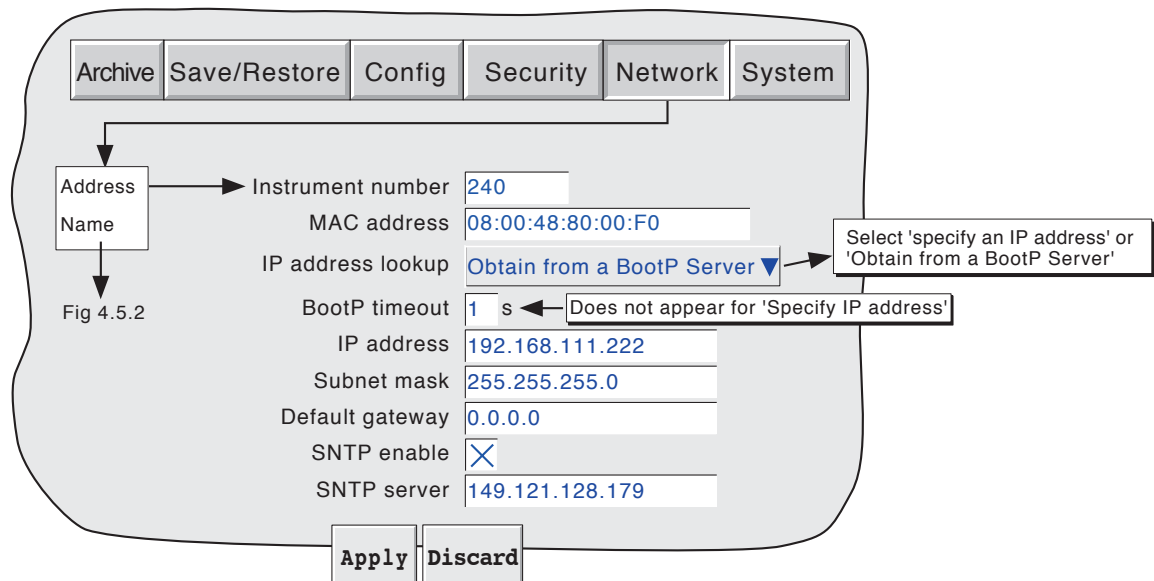

Figure 4.5.1 Network addressing

INSTRUMENT NUMBER/MAC ADDRESS

Unique numbers set up during manufacture to identify the unit to a remote host, or to the unit's manufacturer/distributor, in case of query.

IP ADDRESS LOOKUP

This field allows an address to be entered for the unit. This can be done either by manually entering an address (IP address field - below), or the network service BootP can be used to assign an IP address to the unit.

BOOTP TIMEOUT

This is the maximum time the unit will wait, at power-up, for a response from the BootP server. If no response is received within this time, the IP address, Subnet mask and Default gateway are all set to, or remain at 0.0.0.0

IP ADDRESS

Allows manual entry of the unit's internet protocol (IP) address only if 'Specify an IP address' is selected in the 'IP address lookup' picklist above.

SUBNET MASK

This field is editable only if 'Specify an IP address' is selected in the 'IP address lookup' picklist above. The subnet mask is the network address plus the bits in the host address reserved for sub-network identification. By convention, all the network address bits are set to 1. The subnet mask is used to identify the subnet to which an IP address belongs by performing a bitwise AND on the mask and the IP address.

4.5.1 NETWORK ADDRESS (Cont.)

DEFAULT GATEWAY

To deliver traffic from one subnet to another, devices called 'routers' or 'gateways' are placed between segments. The default gateway address informs each network device where to send data if the target station does not reside on the same subnet as the source.

SNTP ENABLE

This tick box allows time synchronisation from a Simple Network Time Protocol (SNTP) server to be enabled and disabled. When enabled, the instrument time is updated every 15 minutes.

SNTP SERVER

If 'Obtain from BootP server' is selected as the IP address look-up (see above), then this address appears automatically. Otherwise this area allows an IP address to be entered for the SNTP server.

Notes:

1. SNTP is a protocol that allows clients on a TCP/IP network to set their times to that of a server - port number 123. The unit can act both as a client and as a server; when acting as a server, the resolution is 1 msec.
 2. SNTP time is based on elapsed seconds since 00:00 hrs on 1st January 1900. The time is not affected by time zones or daylight saving adjustments.
 3. If the instrument time differs from the SNTP time by less than 2 seconds, the instrument time is updated gradually (1 msec 8 times a second) to prevent time change events being recorded. If the difference is greater than 2 seconds, this is defined as a 'time change event', the results of which are that the instrument time is immediately updated, and a green line is drawn across the chart (vertical trend/history only) to indicate the time change.
 4. If more than 5 time change events occur within 24 hours, a 'Time Synchronisation failure' instrument alarm is set 24 hours after the first event. Once synchronisation is re-established, the alarm self-clears within 24 hours.
 5. An 'SNTP server failure' instrument alarm is flagged if the configured server cannot be accessed, or if the year received from the server is less than 2001 or more than 2035.
 6. When the instrument is acting as a server and a 'Clock Failure' instrument alarm is active, the server time is set to 1/1/1900 which is ignored by clients.
 7. Servers such as Microsoft 'TimeServ' cannot be used with this series of instruments because they are not SNTP servers.
-

4.5.2 Name

Figure 4.5.2 shows the 'Name' fields

.Figure 4.5.2 network name fields

LOCAL HOST

English language name for the unit - Assigned to the IP Address

DOMAIN

The name of the Group or area of networked units which contains this data acquisition unit.

DOMAIN NAME SERVICE (DNS)

Enables the mapping of host names to IP addresses and *vice-versa*.

PRIMARY/SECONDARY DNS SERVER

IP addresses supplied by IT department or the Domain manager or Supervisor.

Note: Any one or more of the above items may be overwritten if 'IP address lookup' is set to 'Obtain from BootP Server' as described under 'Address' above.

4.6 SYSTEM

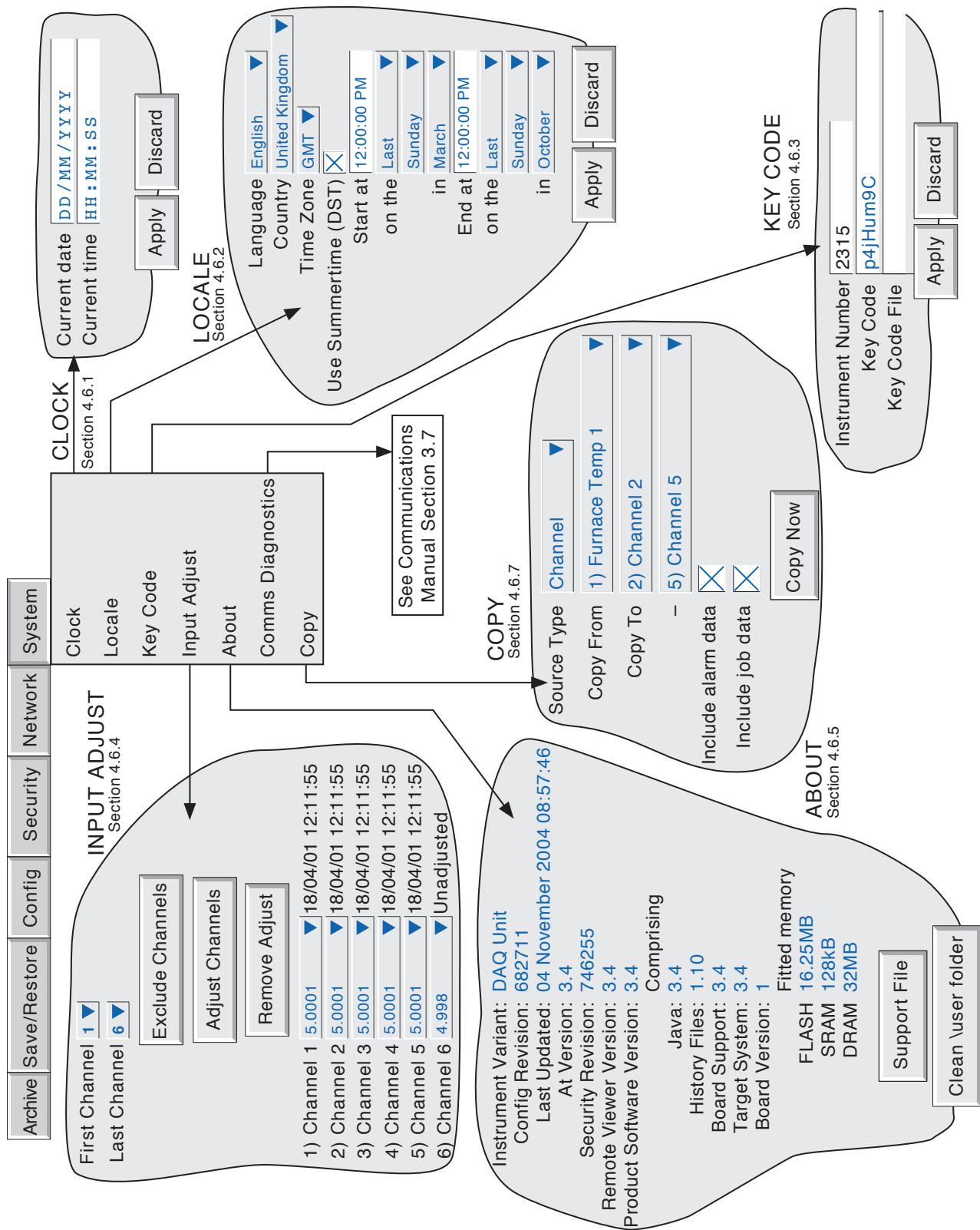

Figure 4.6 System configuration menu layout

4.6 SYSTEM (Cont.)

Clicking on the System key calls the pick list: Clock, Locale, Keycode, Input adjust About

Figure 4.6 above, shows an overview of the System Menus.

4.6.1 Clock

Selecting 'clock' causes the instrument's date and time to be displayed. To edit the date, click in the current date area, to call the keyboard and enter the new numbers. The date is edited in a similar way. The settings apply as soon as the 'Apply settings' button is clicked on. See also SNTP details in [section 4.5.1](#).

4.6.2 Locale

This allows the setting of the following items:

| | |
|-----------------------|---|
| Language | Choose the required language from the picklist |
| Country | Displays a pick list of countries associated with the selected language |
| Time zone* | Select required timezone from picklist. |
| Use Summertime (DST)* | Select box if daylight saving is to be used, If 'Use Summertime (DST)' is selected, the times and dates for the start and end of summertime can be entered using picklists - see figure 4.6 |

Notes

- 1 Date format DD/MM/YY or MM/DD/YY is defined by the language and country selected. Time format (e.g. 12/24 hr. clock) is defined by the country selected.
2. The unit's locale information should match that of the pc, or the displayed time will be incorrect.

*Note: For more information, see Annex B (section B6) and/or <http://www.timeanddate.com>

4.6.3 Keycode

This is a means of allowing new options to be enabled, by the entering of a code, using standard text entry techniques, or by reading a file. If a file is specified, the first line of the file must be the Key Code. To select the file for reading, the Key Code File field is clicked on, to display the file list

The Instrument Number, which must be quoted if ordering upgrades, is unique to the instrument and is not user editable.

4.6.4 Input adjust

This facility allows the user to compensate for tolerance errors etc. The technique used is to select those channels to which adjust is to be applied, then for each channel:

- a apply a known low level signal (at or close to the low input range value) to the relevant input. When the displayed reading is steady, press 'Apply'.
- b. apply a known high level signal (at, or close to, the high input range value) to the relevant input. When the displayed reading is steady, press 'Apply'.

Note: Input adjust cannot be applied to input channels with input type of 'Digital', 'Test' or 'com-
ms'.

4.6.4 INPUT ADJUST (Cont.)

Figure 4.6.4a shows the initial display which appears when 'Input adjust' is first selected from the SYSTEM menu. Channels 1 to 6 are selected by default.

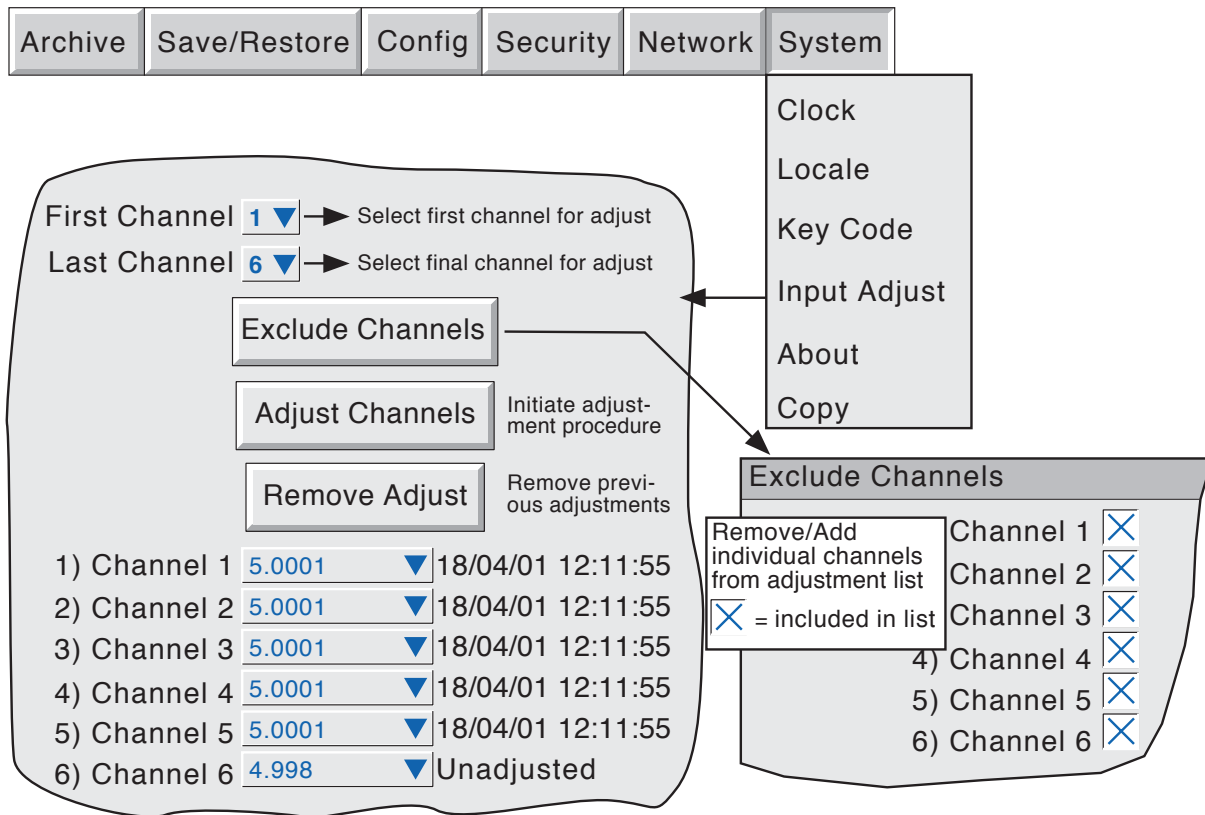

Figure 4.6.4a Input adjust status page

| | |
|-------------------|---|
| First channel | Allows the user to select the lowest channel number of all the channels to be adjusted. |
| Last channel | Allows the user to select the highest channel number of all the channels to be adjusted. |
| Exclude Channels | Presents a list of all the channels from the First channel to the Last channel inclusive, each of which can be removed from the list by 'unchecking' its check box. The channels displayed in the status page reflect this selection. |
| Adjust channels | Initiates the adjustment procedure to all the channels from the First channel to the Last channel inclusive, unless the effectivity is modified using the Select Channels key. |
| Remove Adjust | Returns the selected channels to factory calibration |
| 1) Channel 1 etc. | A list of channels required to be susceptible to the adjustment procedure, together with their current values and their adjustment status (i.e. Unadjusted or, the time/date of the previous adjustment (if any)). |

4.6.4 INPUT ADJUST (Cont.)

ADJUST PROCEDURE

Operation of the Adjust Channels key calls the low-end adjust page, as shown in figure 4.6.4b.

Archive Save/Restore Config Security Network System

Specify the sensor low point and connect the corresponding input.

Low Point

When the values below have settled select Apply.

| | | |
|--------------|--------------------------------------|------------|
| 1) Channel 1 | <input type="text" value="-0.0026"/> | Unadjusted |
| 2) Channel 2 | <input type="text" value="-0.0001"/> | Unadjusted |
| 3) Channel 3 | <input type="text" value="-0.0002"/> | Unadjusted |
| 4) Channel 4 | <input type="text" value="-0.0002"/> | Unadjusted |
| 5) Channel 5 | <input type="text" value="0.0000"/> | Unadjusted |
| 6) Channel 6 | <input type="text" value="0.0000"/> | Unadjusted |

Apply Discard

Figure 4.6.4b Typical low-end input adjust page

Low Point Usually 0, but a different value can be entered here, if required.

Apply the Low point value to the relevant input channels, and wait some minutes for the displayed readings to become stable. When the readings are stable, press the Apply key, to call the High-end page depicted in figure 4.6.4c, below.

Archive Save/Restore Config Security Network System

Specify the sensor low point and connect the corresponding input.

High Point

When the values below have settled select Apply.

| | | |
|--------------|-------------------------------------|------------|
| 1) Channel 1 | <input type="text" value="4.9993"/> | Unadjusted |
| 2) Channel 2 | <input type="text" value="4.9972"/> | Unadjusted |
| 3) Channel 3 | <input type="text" value="5.0010"/> | Unadjusted |
| 4) Channel 4 | <input type="text" value="4.9994"/> | Unadjusted |
| 5) Channel 5 | <input type="text" value="5.008"/> | Unadjusted |
| 6) Channel 6 | <input type="text" value="5.011"/> | Unadjusted |

Apply Discard

Figure 4.6.4c Typical high-end input adjust page

High Point Default value displayed, but a different value can be entered here, if required.

Apply the High point value to the relevant input channels, and wait some minutes for the displayed readings to become stable. When the readings are stable, press the Apply key, to return to the status page.

Note: Adjusting a channel invalidates the accuracy values given in the specification in Annex A for that channel.

4.6.5 About

Selecting 'About' gives details of the version numbers of different aspects of the unit, and details of the amount of memory fitted. Figure 4.6.5 shows a typical 'About' display page

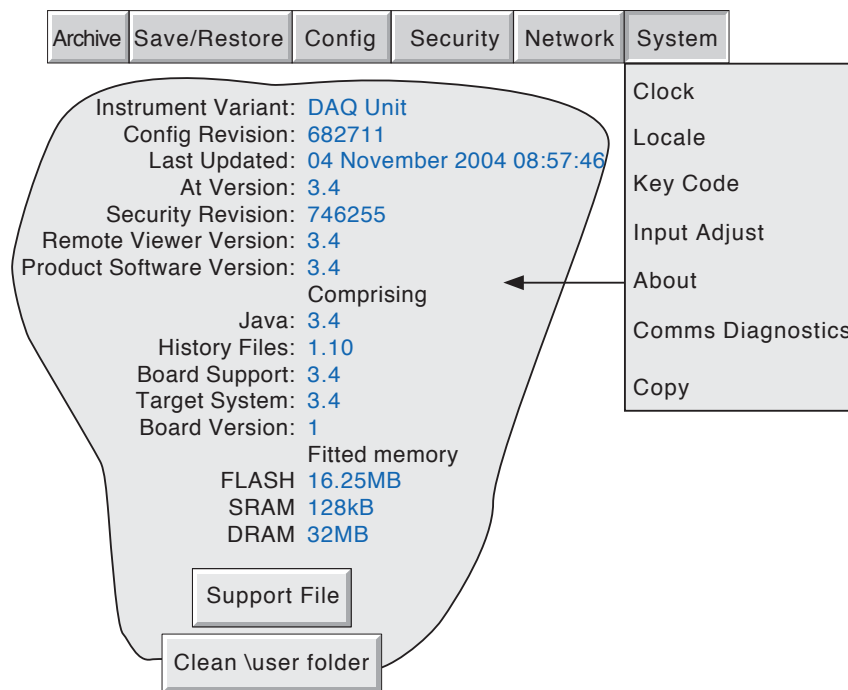

Figure 4.6.5 About display (typical).

INSTRUMENT VARIANT

Displays an instrument type code.

CONFIG REVISION

Whenever a change to the Configuration of the instrument is applied the 'Config Revision' is incremented. For these purposes, Configuration is defined as including all items within the menu structures of the Config and Network keys, and includes User Screens. It does not include those items associated with the Security key. Config Revision is printed on the 'chart' at power up, and if the Auditor Pack option or the Batch option is fitted, Config Revision is included in the messages associated with these options.

Notes:

1. Config Revision can be used as an input to one or more maths channels. If such a channel is included in one or more groups, the Revision number can be determined for any time/date when Trend History mode is invoked for the group(s) in question. See the Options Manual for maths option details.
2. Config Revision can be embedded in one or more messages, as described in section 4.3.8.

LAST UPDATED

The time and date at which the configuration was last edited.

AT VERSION

The version number at the time of the last configuration update.

4.6.5 ABOUT (Cont.)

SECURITY REVISION

Whenever a change is made to an item within the Security menus, the Security Revision is incremented. Security Revision is printed on the 'chart' at power up, and if the Auditor Pack option or the Batch option is fitted, Security Revision is included in the messages associated with these options. See notes 1 and 2 below.

Notes:

1. Security Revision can be used as an input to one or more maths channels. If such a maths channel is included in one or more groups, the Revision number can be determined for any time/date when Trend History mode is invoked for the group(s) in question. See the Options Manual for maths option details.
2. If 'Centralised Security' is enabled, the Security Revision is presented in a different format (15.001, for example). See section 4.4.2 for further details.

SUPPORT FILE

If the unit is not performing as it should (e.g. it resets itself unexpectedly), the Support File key allows the user to save 'critical system files' into a single file (SupportInfo.uhq*) to the instrument's floppy disk/pc card, or to the remote viewer's PC, for despatch to the manufacturer for analysis. For security reasons, this file cannot be viewed by anyone other than the manufacturer or his agents.

Once the save operation is complete, a 'Support' message appears on the screen giving details of where to send the file. More information is held in the file 'SupportInfo.txt' which is also saved to the disk. This file can be opened, and the information within it read, by inserting the disk into a PC, clicking on the floppy disk icon (A drive) in 'My Computer' and then double clicking on the file icon when it appears.

* 'SupportInfo' is the default name. This name may be edited by the user before saving to disk or pc. The .uhq suffix is automatically appended to the new name.

CLEAN \USER FOLDER

Notes:

1. This button appears only for users with 'Full Configuration' access permission.
2. Before carrying out this operation, it is recommended that all required files are saved to disk, or pc card.

Operating this button causes the instrument to delete 'unnecessary' files from the \user folder, and to compress (zip) others such as user screens. Permission is asked before configuration files, user screens etc. are deleted.

Note: 'Yes to All' applies only to remaining files. It does not delete files for which delete permission has previously been denied.

Once all deletions are complete, a list of deleted items is displayed.

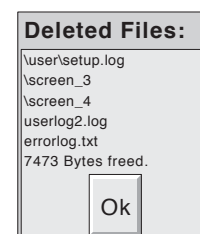
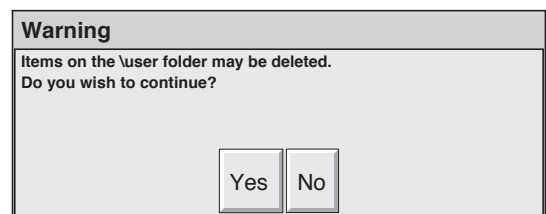

4.6.6 Comms Diagnostics

This menu item is concerned only with Master comms diagnostics, and is fully described in Section 3 of the Communications Manual.

4.6.7 Copy

This facility allows the user to copy a point or group configuration from one point, group etc. to one or more others. The user may choose whether or not to include alarm and (if applicable) job data when copying point configurations. Descriptors and colour selections are not copied.

Figure 4.6.7 shows a typical configuration page for copying the configuration of channel 1 (Furnace Temp1) to channels 2 to 5 inclusive.

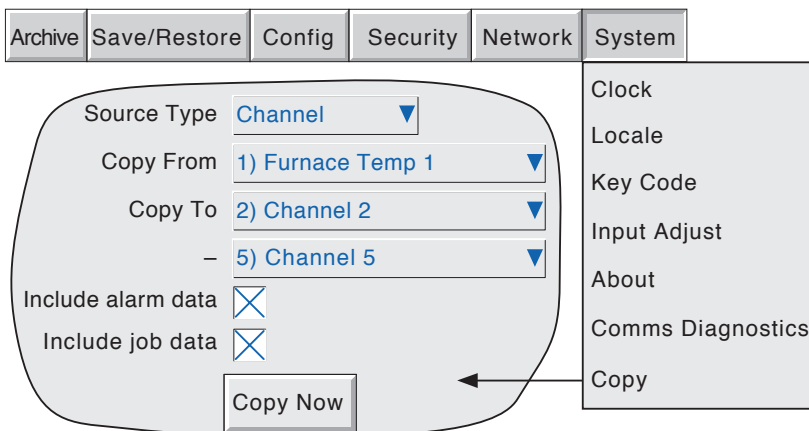
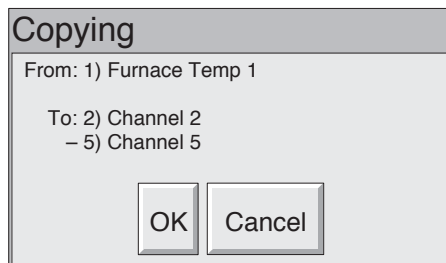

Figure 4.6.7 Copy configuration page (typical)

When 'Copy Now' is operated, a confirmatory dialogue box opens, to allow the user to check the source and destination entries.



CONFIGURABLE PARAMETERS

| | |
|--------------------|---|
| Source Type | Picklist allows selection of Group, Channel, Event, Message, Maths Channel, Totaliser, Counter, Timer, Output or Demand Write, as the type of source to be copied. |
| Copy From | Allows the user to select a specific point, group etc. to be copied |
| Copy To | Allows the first destination point to be selected, for the source to be copied to. |
| - | Allows the final destination point to be selected for the source to be copied to. |
| Include alarm data | This field appears only for source types which support alarms. If this box is 'selected', then alarm data is included in the copy process. |
| Include job data | This field appears only for source types which support jobs. If this box is 'selected', then jobs data is included in the copy. For source types that support both alarms and jobs, it is not possible to include job data, without including alarm data as well. |

4.6.7 COPY (Cont.)

Once the copy is complete, the user should enter the configuration area of the items that have been copied, and edit/apply the changes etc.

COPY RULES

1. The first channel on any input card may not be a digital input type.
2. If a destination channel was a digital input, AND the source channel is an analogue input AND 'include alarm data' is not selected, the destination channel alarm settings will be set as:
Enable = Off; Type = Absolute high; Threshold = 0.0; Dwell = 0.0.
3. If a destination channel was an analogue input, AND the source channel is a digital input AND 'include alarm data' is not selected, the destination channel alarm settings will be set as:
Enable = Off; Type = Digital; Threshold= Closed; Dwell = 0.0.
4. Descriptors and Colours are never copied.

4.7 JOBS

A number of sources (e.g. channel, event, totaliser) can be set up to trigger one or more jobs. The following description includes all possible job categories, but which jobs are available on any particular unit depends on the options fitted to that unit. Many job categories require the relevant access level permission to be set, as described in [section 4.4.1](#), above.

The type of action (continuous or 'single-shot'), available for selection, depends on the type of trigger source. Continuous actions are selected from: Whilst active, Whilst inactive or Whilst unacknowledged. The available single-shot actions are: On becoming active, On becoming inactive, On acknowledgement.

Note: It is recommended that a 'job list' be kept during configuration. A sample template appears in Annex B.

4.7.1 No Action

This means that no job action is configured for the trigger source.

4.7.2 Drive relay

Allows a specific relay to be set up to change state whilst the trigger source is active, inactive or whilst it remains unacknowledged. Relays are normally energised i.e. 'common' (c) is shorted to 'normally open' (no). When in alarm, the relay is de-energised i.e. 'common' (c) is shorted to 'normally closed' (nc). Thus, if power is removed from the unit, all relays automatically 'fail safe' to their alarm conditions. See [section 2.2.1](#) for details of relay output board connector location(s) and pinout.

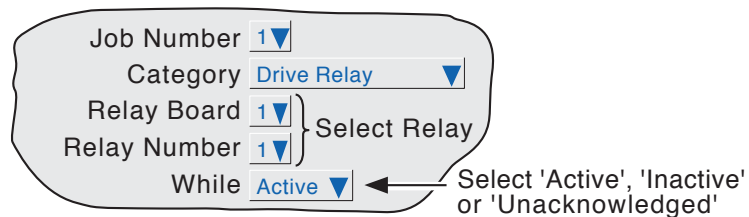

Figure 4.7.2 Relay job menu layout

Note: Relay 1 on Relay board 1 refers to the standard relay. If relay option boards are fitted, Relay board 2 is located in option board slot 1, and Relay Board 2 is located in option board slot 2.

4.7.3 Totaliser category

If the Totaliser option is fitted (section 4 of the Options Manual), the following jobs become available:

- Preset Loads the selected totaliser with the value set up in 'Preset' in the totaliser's configuration menu.
- Preset Group Loads all the totalisers in the specified group with their 'Preset' values.
- Disable Stops the specified totaliser accumulating.
- Disable Group Stops all totalisers in the specified group.

Note: If more than one job is set up to disable a particular totaliser, then any of these jobs going active will disable the totaliser, unless the software version is prior to version 1.7, in which case, all relevant jobs have to be active simultaneously in order to disable the totaliser.

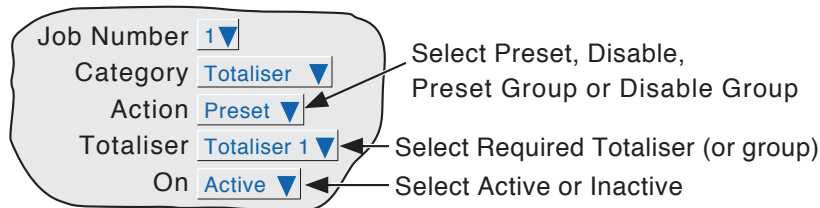

Figure 4.7.3 Totaliser job menu layout

4.7.4 Message category

If the message option is fitted (section 4.3.8), one or more messages can be directed to the display, to 'All groups' or to a 'Specified Group'. The messages must be contiguous - e.g. messages 2, 3 and 4 may be sent, but messages 1, 3 and 4 cannot be sent, without message 2 as well. Group selection fields do not appear for single-group instruments.

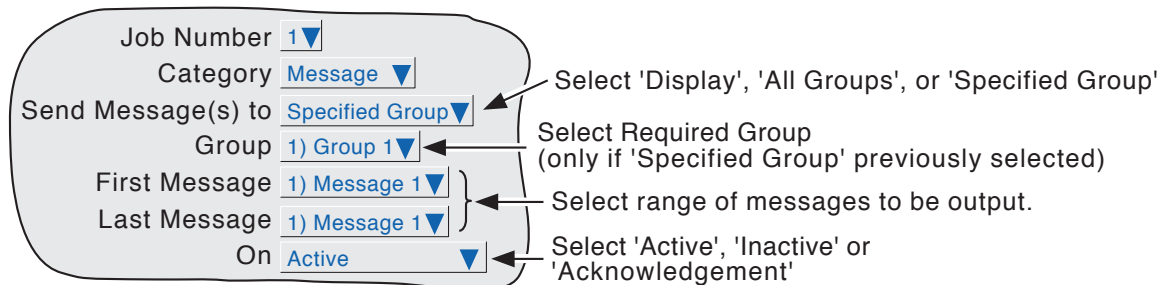

Figure 4.7.4 Message job menu layout

4.7.5 Maths category

If the Maths option is fitted (section 3 of the Options Manual), the following jobs become available to applicable functions:

- Reset Sets the selected maths channel value to zero.
- Disable Stops historical functions such as Fvalue, Stopwatch and Rolling Average from accumulating further values. When the function is subsequently re-enabled, the function re-starts from its pre-disabled value. 'Disable' has no effect on other functions.
- Switch to B Causes the relevant maths channel to copy source B instead of its normal source A - see section 3.1.4 of the Options Manual for further details. This function is not related to the 'A/B Switching' function.
- Trigger Used to initiate a 'Sample and hold' function - see section 3.1.4 of the Options Manual for further details.

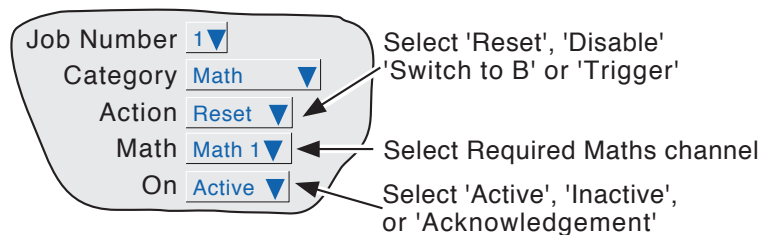

Figure 4.7.5 Maths job menu layout

4.7.6 Clock category

This job causes the System Clock to be Preset to the value entered in Instrument Configuration (Preset Hour, Preset Minute) (Section 4.3.1). This job can be used to synchronise a number of instruments as follows:

- a. For each recorder or data acquisition unit, set up one input channel as follows:
 - Input Type Digital
 - Closed String Synch (for example)
 - Enable..... Trigger
 - Active when Synch
 - Job 1 category.. Clock
 - Job 1 action Preset
 - Job 1 On Active
 - b. For each instrument, set the same preset hour and minute in Instrument Configuration.
 - c. For each instrument provide a simultaneous pulse or contact closure to the digital input previously set up.
- The instruments will all be automatically set to the preset time on receipt of the input.

An alternative way of synchronising is via an SNTP time server as described in section 4.5.1.

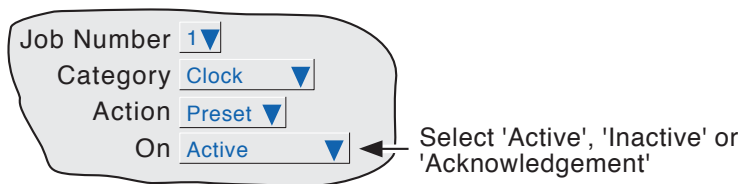

Figure 4.7.6 Clock job menu layout

Note: Whenever a time change occurs, a green line is drawn across the chart in vertical trend mode

4.7.7 Counter category

If the Counter option is fitted (section 5 of the Options Manual), the following jobs become available:

Preset counter Loads the selected counter with the preset value set in the configuration for that counter.

Disable counter Stops the selected counter.

Increment Adds 1 to the selected counter's value.

Decrement Subtracts 1 from the selected counter's value.

Preset group Loads all the counters in the specified group with their 'Preset' values.

Disable group Stops all counters in the specified group.

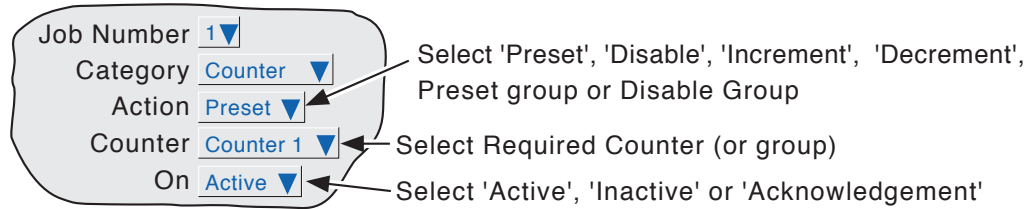

Figure 4.7.7 Counter job menu layout

4.7.8 Timer category

If the Timer option is fitted (section 6 of the Options Manual), the following jobs become available:

1. Reset timer - sets the timer to zero
2. Start timer - causes the timer to start.
3. Disable timer - stops the timer.

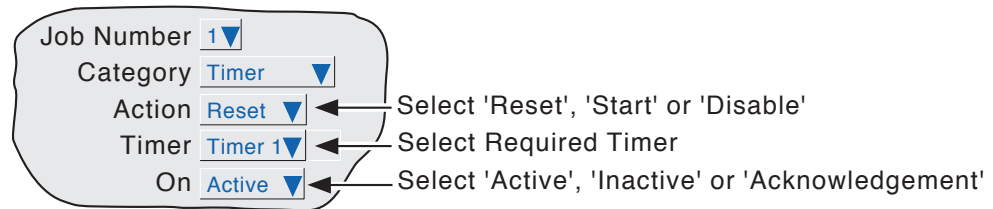

Figure 4.7.8 Timer job menu layout

4.7.9 Batch Category

If the Batch option (section 1 of the Options Manual) is fitted, a previously 'Stored' batch can be started by job action or by a Batch Start command sent via MODBUS/TCP (section 2.4.4 of the Communications Manual). If a batch is already running, it will be restarted. In Batch configuration, if Scope = Group, then a specific group can be selected for the batch job to act on; if Scope = Instrument, the Group selection field does not appear.

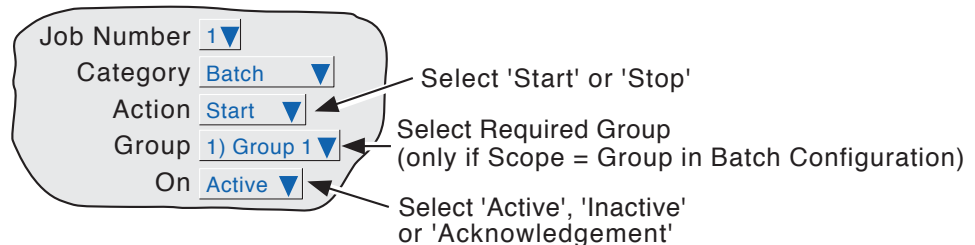

Figure 4.7.9 Batch job menu layout

4.7.10 Recording category

A Recording job:

- a) allows the user to record to a specified group's history file, only by job initiation.
- b) allows the recording speed/interval B to be selected for use, for the duration of the job. See 'Group configuration for A/B switching details.

Notes:

- 1 The group in question will be recorded only if Recording Enable selected in group Configuration (section 4.3.2) and the job is active.
2. If the Auditor Pack option is fitted, then in order to preserve the audit trail, messages will be saved in the group's history files even when recording is not enabled by job.
3. A blue line is drawn across the 'chart' whenever a recording job is used to disable/enable recording.

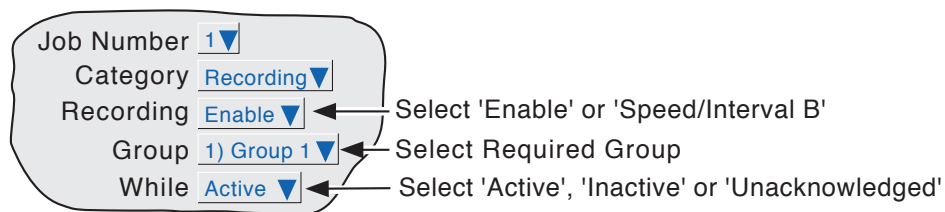

Figure 4.7.10 Recording job menu layout

4.7.11 Trend category

Trend jobs allow the following actions to occur:

- Span B Switches the point being configured to span B and zone B, for as long as the job is active.
- Span B Group Switches all the points in the selected group to their individual spans and zones B, for as long as the job is active.
- Colour B Switches the point being configured to colour B, for as long as the job is active.
- Colour B Group Switches all the points in the selected group to their individual colours B, for as long as the job is active.
- Speed/Interval B Switches Trend Speed/Interval for the selected group to Speed/Interval B, for as long as the job is active.

Note: Default B values are the same as the initial default 'A' Values. Thus, if a 'B' value has not been set, the default 'A' value will be used.

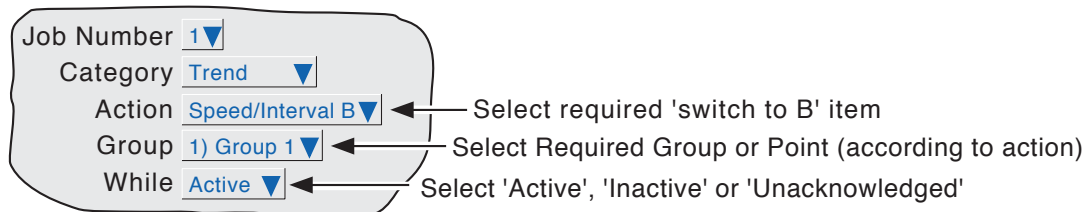

Figure 4.7.11 Trend job menu layout

4.7.12 Output category

Applies only to instruments with Modbus master option fitted.

Output jobs allow specific analogue output writes to be disabled, from the instrument, when it is acting as a modbus master.

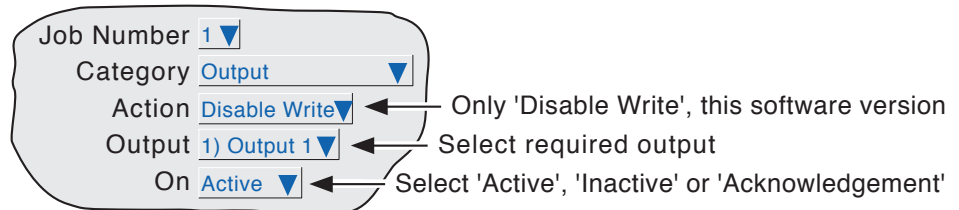

Figure 4.7.12 Output Job menu layout

4.7.13 Demand Writes category

Applies only to instruments with Modbus master option fitted.

Demand Writes jobs allow the user to set up the instrument so that, when the job is triggered, it initiates the selected Demand Write. The write action is performed to the remote device as defined in Demand Write Configuration described in section 3.4 of the Communications Manual.

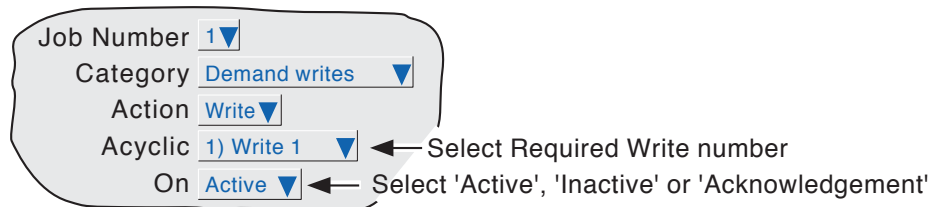

Figure 4.7.13 Demand write jobs menu layout

4.7.14 Alarm category

This allows the user to set up a job to acknowledge or disable point alarms as follows:

- Acknowledge All Alarms Acknowledges all alarms
- Acknowledge Alarms on Group Acknowledges all alarms in the specified group
- Acknowledge Alarms on Point Acknowledges all alarms associated with the specified point
- Acknowledge Alarm Acknowledges specific alarm
- Disable All Alarms Disables all alarms
- Disable Alarms on Group Disables all alarms in the specified group
- Disable Alarms on Point Disables all alarms associated with the specified point
- Disable Alarm Disables a specific alarm

Further selection boxes allow a group or point, respectively, to be defined.

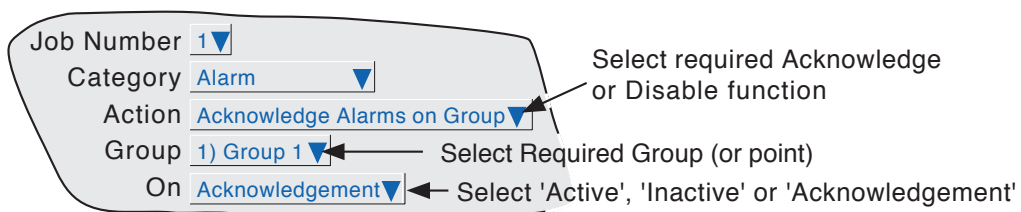

Figure 4.7.14 Alarm job menu layout

4.7.15 Archive category

Archive jobs allow a job to be used to trigger an archive to the host computer using FTP transfer. The following jobs are available:

- Archive Last Hour, Last Day, Last 7 Days or Last 31 days to FTP
- Bring FTP archive up to date
- Cancel Archive to FTP
- Archive Last Hour, Last Day, Last 7 Days or Last 31 days to Media
- Bring Media Archive up to date
- Suspend Archive to Media
- Cancel Archive to Media

These jobs copy the archiving functions available from the 'Archive' key described in section 4.1 of this document.

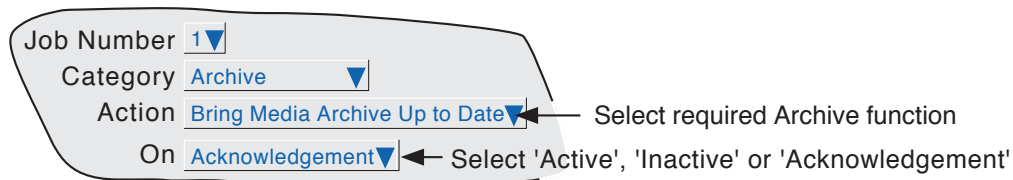

Figure 4.7.15 Archive jobs menu layout

4.7.16 Email category

Allows the user to send a specified e-mail to the recipients set up in e-mail configuration (see section 11 of the Options Manual). A system message is generated and sent to all recording groups whenever an e-mail is sent.

4.7.17 Report Category

This category is available only when the ASCII Printer Output option is fitted. See the Communications manual for further details.

The screenshot shows a job menu for the 'Report' category. It contains five dropdown menus with the following values and annotations:

- Category:** Report
- Send Report to:** Group (Annotation: ← Select 'Group' or Printer)
- Group:** 3) Furnace 3 (Annotation: ← If destination = 'Group', select destination group.)
- Report:** 2) Current temps (Annotation: ← Select the report to be sent)
- On:** Active (Annotation: ← Select 'Active', Inactive or 'Acknowledgement'.)

Figure 4.7.17 Report category job menu

SEND REPORT TO

Allows the user to select 'Group' or 'Printer1 / 2'. If 'Group' is selected (as in the figure above), a further field appears allowing the user to specify the group to which the report is to be sent (Group 3 in the figure above). If 'Printer 1' is selected the report is sent to a connected ASCII printer. 'Printer 2' is not supported in this software version.

GROUP

This field appears only if 'Group' has been selected as the report destination, and allows the actual destination group to be defined. If a [group descriptor](#) has been entered ('Furnace 3' in the figure above), then this descriptor appears in the field.

REPORT

This defines which of the reports is to be sent when the job is triggered. If a Report descriptor has been entered, then this appears in the field ('Current temps' in the figure above)

This page is deliberately left blank

ANNEX A: SPECIFICATION

INSTALLATION CATEGORY AND POLLUTION DEGREE

This product has been designed to conform to BS EN61010 installation category II and pollution degree 2. These are defined as follows:

Installation category II

The rated impulse voltage for equipment on nominal 230V ac mains is 2500V.

Pollution degree 2

Normally, only non-conductive pollution occurs. Occasionally, however, a temporary conductivity caused by condensation shall be expected.

TECHNICAL SPECIFICATION (Acquisition Unit)

Board types (I/O)

Six-channel universal input board (standard)
 Additional six-channel universal input board (option)
 Six-input event input board (option)
 1 Change over relay (standard)
 3 Change-over relay output board (option)
 Serial communications board (option)

Standard features

File transfer protocol (FTP)
 MODBUS TCP
 Messages
 Remote viewer

Other options

ASCII Printer Output
 Auditor Pack
 Batch Recording
 Circular trend
 CSV format for archive files
 E-mail
 Event buttons
 Log scales
 Master Comms
 Maths/Totalisers/Counters/Timers
 Multiple Groups
 Screen Builder (User screens) 'Lite' and Full versions
 Security Manager

Environmental Performance

| | | |
|----------------------------|--------------------|-------------------------------|
| Temperature limits | Operation: | 0 to 50°C |
| | Storage: | - 20 to +70°C |
| Humidity limits | Operation/Storage: | 5% to 95% RH non - condensing |
| Protection | | IP20 |
| Shock | | BS EN61010 |
| Vibration (10 Hz to 150Hz) | | 2g peak |
| Altitude (maximum) | | <2000 metres |

Physical

| | | |
|--------------------------|----------------------|---|
| Mounting method | | T35 DIN rail, or wall mounting |
| Size | W x H x D: | 208.9 mm x 176.5 mm x 68.2 mm |
| Front face distance from | Wall: | 79 mm |
| | DIN Rail: | 73.5 mm from front face of rail |
| Weight | | <1500 grammes |
| Mounting angle | Thermocouple inputs: | Connector(s) must be horizontal along their length axis for specified cold junction performance |
| | Other inputs: | No constraint |

See figure 2.1 for installation details

Electromagnetic compatibility (EMC)

| | |
|------------------------|------------|
| Emissions and immunity | BS EN61326 |
|------------------------|------------|

Electrical safety

BS EN61010 [Installation category II, Pollution degree 2](#)

Operator interface

Full operation, configuration and file transfer between unit and remote PC

TECHNICAL SPECIFICATION (Acquisition Unit) (Cont.)**Power requirements**

| | |
|---------------------|--------------|
| Supply Voltage | 18 to 30V dc |
| maximum power drain | 10 W |
| Inrush Current | 18 Amps |

Back-up battery

| | |
|--------------------|--|
| Type | Poly-carbonmonofluoride/lithium (BR2330). Part Number PA261095 - see Annex B . |
| Support time | A fully-charged, new battery supports the Real-Time Clock for a minimum of 1 year with the unit unpowered |
| Replacement period | 3-years |
| Stored data | Time; date; values for totalisers, counters and timers; batch data; values for those maths functions with history, such as Fvalue, Rolling average, Stopwatch etc. |

Clock (RTC) data

| | | |
|-----------------------|-----------------|-----------------|
| Temperature stability | 0 to 40°C: | -3 to +2 ppm |
| | -40 to + 85 °C: | ± 7.5 ppm |
| Ageing | | ±1 ppm per year |

Update/archive rates

| | |
|---------------------------------|--|
| Input/relay output sample rate: | 8 Hz. |
| Display update: | Network dependent |
| Archive sample value: | Value at sample time |
| Trended/displayed value: | Latest value at display update time |
| Calculations: | 8Hz update of all alarm setpoints, maths, totaliser, counter etc. values |

Ethernet communications

| | |
|-------|----------------------------|
| Type | IEEE802.3 10BaseT |
| Cable | Type: CAT5 |
| | Maximum length: 100 metres |
| | Termination: RJ45 |

Serial communications option

| | |
|-----------------------------------|---|
| Isolation (dc to 65Hz BS EN61010) | Installation category II; Pollution degree 2. |
| Terminals to ground: | 100 V RMS or dc (basic insulation) |
| Transmission standard | EIA232 or EIA485 |

TECHNICAL SPECIFICATION (Universal input board)

General

| | |
|------------------------------------|--|
| Termination | Edge connector/terminal block |
| Max. number of inputs | 12 (6 standard, 6 optional) |
| Input ranges | ±38mV; ±150mV; ±1Volt; ±10Volts |
| Input types | Dc volts, dc millivolts, dc milliamps, (with external shunt), thermocouple, 2/3 wire resistance temperature detector (RTD), Ohms, Contact closure (not channels 1 or 7) (Minimum contact closure = 60msec.) |
| Input type mix | Freely configurable |
| Sample rate | See 'Update information' above |
| Noise rejection (48 to 62Hz) | |
| Common mode: | >140dB (Channel to channel and channel to ground) |
| Series mode: | >60dB |
| Maximum common mode voltage | 250 Volts continuous |
| Maximum series mode voltage | 45mV at lowest range; 12Volts peak at highest range |
| Isolation (dc to 65Hz; BS EN61010) | Installation category II ; Pollution degree 2 300V RMS or dc channel to channel (double insulation), channel to common electronics (double insulation) and channel to ground (basic insulation) |
| Dielectric strength | Channel to ground: 1500Vac for 1 minute. Channel to channel: 2500Vac for 1 minute |
| Insulation resistance | >10MΩ at 500V dc |
| Input impedance | 10V range: 68.8kΩ Other ranges: >10MΩ |
| Overvoltage protection | 50V peak (150V with attenuator) |
| Open circuit detection | ± 57nA max Recognition time: 500mSec Minimum break resistance: 10MΩ |

DC input ranges

| | |
|-------------------------------|-------------------------------------|
| Shunt | Externally mounted resistor modules |
| Additional error due to shunt | 0.1% of input |
| Performance | See table |

| Low Range | High Range | Resolution | Maximum error (Instrument at 20°C) | Worst case temperature performance |
|-----------|------------|------------|------------------------------------|------------------------------------|
| -38 mV | 38 mV | 1.4 μV | 0.085% input + 0.051% range | 80ppm of input per deg C |
| -150 mV | 150 mV | 5.5 μV | 0.084% input + 0.038% range | 80ppm of input per deg C |
| -1 V | 1 V | 37 μV | 0.084% input + 0.029% range | 80ppm of input per deg C |
| -10 V | 10 V | 370 μV | 0.275% input + 0.030% range | 272ppm of input per deg C |

TECHNICAL SPECIFICATION (Universal input board) (Cont.)

Resistance inputs

| | |
|------------------------------|--|
| Temperature scale | ITS90 |
| Types, ranges and accuracies | See tables (values exclude influence of lead resistance) |
| Influence of lead resistance | Error: Negligible |
| Mismatch: | 1Ω/Ω |

Thermocouple data

| Low Range | High Range | Resolution | Maximum error (Instrument at 20°C) | Worst case temperature performance |
|-----------|------------|------------|------------------------------------|------------------------------------|
| 0Ω | 150Ω | 5mΩ | 0.045% input + 0.110% range | 35ppm of input per deg C |
| 0Ω | 600Ω | 22mΩ | 0.045% input + 0.065% range | 35ppm of input per deg C |
| 0Ω | 6kΩ | 148mΩ | 0.049% input + 0.035% range | 35ppm of input per deg C |

| RTD type | Overall range (°C) | Standard | Max. linearisation error |
|----------|--------------------|------------------------|--------------------------|
| Cu10 | -20 to + 400 | General Electric Co. | 0.02°C |
| Cu53 | -70 to + 200 | RC21-4-1966 | < 0.01°C |
| JPT100 | -220 to + 630 | JIS C1604:1989 | 0.01°C |
| Ni100 | -60 to + 250 | DIN43760:1987 | 0.01°C |
| Ni120 | -50 to + 170 | DIN43760:1987 | 0.01°C |
| Pt100 | -200 to + 850 | IEC751 | 0.01°C |
| Pt100A | -200 to + 600 | Eurotherm Recorders SA | 0.09°C |
| Pt1000 | -200 to + 850 | IEC751 | 0.01°C |

| | |
|----------------------------------|--|
| Temperature scale | ITS90 |
| Bias current | 0.05nA |
| Cold junction compensation types | Off, internal, external, remote |
| Remote CJC source | Any input or maths channel |
| Internal CJC error | 1°C max with instrument at 25°C |
| Internal CJC rejection ratio | 50:1 minimum |
| Upscale/downscale drive | Types: 'High', 'low' or 'none' selectable for each thermocouple channel. |
| Additional error: | Typically 0.01°C - depends on wiring. (Detect current = 57nA.) |
| Types, ranges and accuracies | See table |

| T/C type | Overall range (°C) | Standard | Max.linearisation error |
|-----------------|--------------------|---------------------------|--|
| B | 0 to + 1820 | IEC584.1 | 0 to 400°C = 1.7°C 400 to 1820°C = 0.03°C |
| C | 0 to + 2300 | Hoskins | 0.12°C |
| D | 0 to + 2495 | Hoskins | 0.08°C |
| E | -270 to + 1000 | IEC584.1 | 0.03°C |
| G2 | 0 to + 2315 | Hoskins | 0.07°C |
| J | -210 to + 1200 | IEC584.1 | 0.02°C |
| K | -270 to + 1372 | IEC584.1 | 0.04°C |
| L | -200 to + 900 | DIN43710:1985 (To IPTS68) | 0.02°C |
| N | -270 to + 1300 | IEC584.1 | 0.04°C |
| R | -50 to + 1768 | IEC584.1 | 0.04°C |
| S | -50 to + 1768 | IEC584.1 | 0.04°C |
| T | -270 to + 400 | IEC584.1 | 0.02°C |
| U | -200 to + 600 | DIN43710:1985 | 0.08°C |
| NiMo/NiCo | -50 to + 1410 | ASTM E1751-95 | 0.06°C |
| Platinel | 0 to + 1370 | Engelhard | 0.02°C |
| Ni/NiMo | 0 to + 1406 | Ipsen | 0.14°C |
| Pt20%Rh/Pt40%Rh | 0 to + 1888 | ASTM E1751-95 | 0.07°C |

TECHNICAL SPECIFICATION (Relay output board)

General

Maximum number of relay boards

- Standard: 1 board with 1 change-over relay
- Optional: 1 or 2 boards, each with three changeover relays

Estimated mechanical life 30,000,000 operations

Update rate See 'Update/archive rates' in 'Aquisition Unit specification' above

AC load ratings

Derating

The figures given below are for resistive loads. For reactive or inductive loads, de-rate in accordance with graph 1, in which

- F1 = Actually measured results on representative samples
- F2 = Typical values (according to experience)
- Contact life = Resistive contact life x reduction factor.

Maximum switching power 500 VA

Maximum contact voltage 250 V providing this does not cause the maximum switching power (above) to be exceeded

Maximum contact current 2 Amps providing this does not cause the maximum switching power (above) to be exceeded

DC load ratings

Maximum switching power See graph 2 for operating Volt/Amp envelope

Maximum contact voltage/current See graph 2 for examples.

Safety isolation

Isolation (dc to 65 Hz; BS EN61010) Installation category II; Pollution degree 2

Contact to contact: 300V RMS or dc (double insulation)

Contact to ground: 300V RMS or dc (basic insulation)

TECHNICAL SPECIFICATION (Event input board)

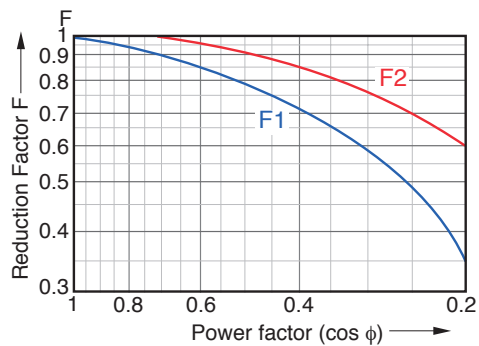

Graph 1 Derating curves for ac loads

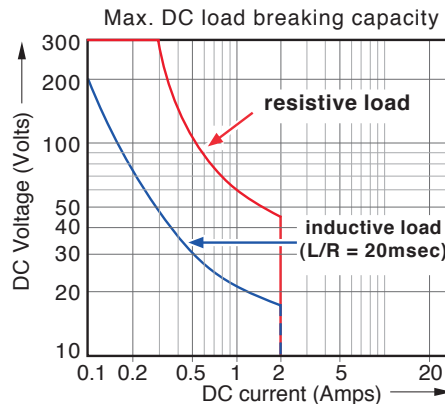

Graph 2 DC load switching curves

Event input board

See Options manual (section 7)

TECHNICAL SPECIFICATION (ASCII Printer)

ASCII Printer

See the documentation supplied with the printer

ANNEX B: REFERENCE

B1 PREVENTIVE MAINTENANCE

B1.1 MAINTENANCE SCHEDULE

Battery replacement - Every three years

B1.2 BATTERY REPLACEMENT PROCEDURE

1. With reference to figures B1.2a and B1.2b, as necessary, remove the I/O connectors (push inwards, on the clamp located at each end of the connector, to release). Disconnect the power connector, and, the safety earth connection.
2. Remove the unit from the wall or DIN rail.
3. At the rear of the unit, undo screw 'A', (figure B1.2c) then lay the unit on its back face.

(Continued)

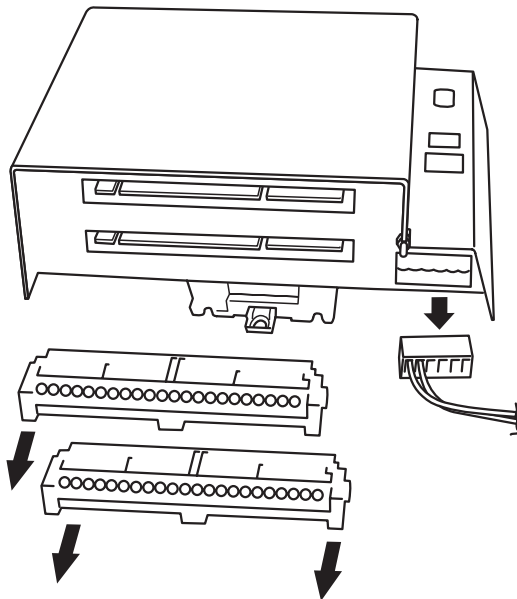

Figure B1.2a Remove electrical connections

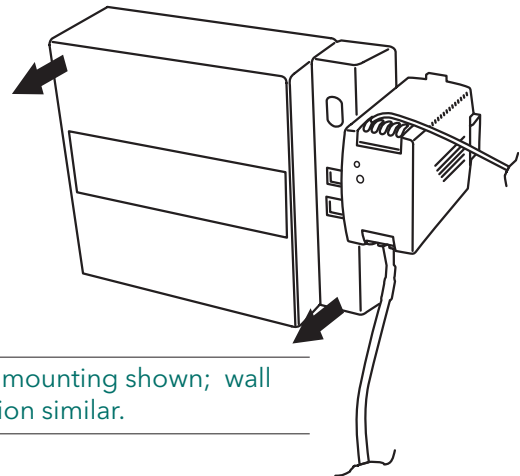

Figure B1.2b Remove unit from wall or DIN rail

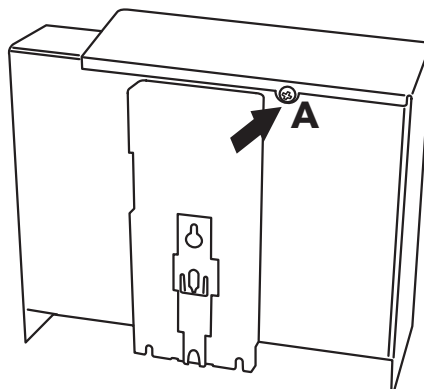
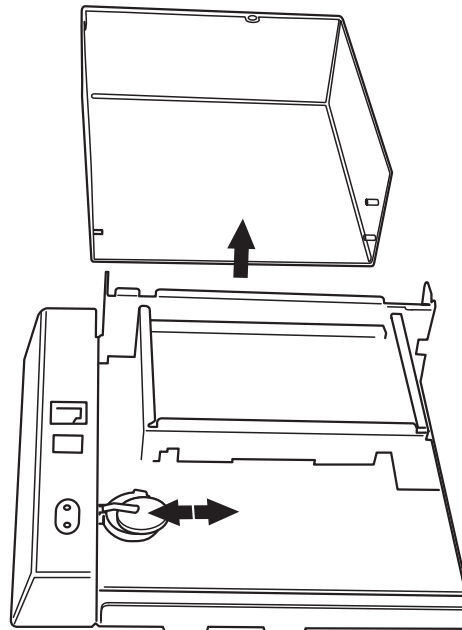

Figure B1.2c Remove securing screw 'A'

B1.2 BATTERY REPLACEMENT (Cont.)

3. Rotate/lift the cover to remove it (figure B1.2d).
4. Slide the exhausted battery out of the battery holder (figure B1.2d), and dispose of the battery according to local environmental regulations for poly-carbonmonofluoride/lithium batteries
5. Slide the replacement battery into the holder.
6. Reassemble the unit, and reconnect the wiring.
7. Remount the unit on the wall or DIN rail



Battery type BR2330
Part Number PA261095

Figure B1.2d Replace battery

B2 OPTION ENABLING

In order to enable software functions, a key code or file, obtained from the manufacturer, must be entered in the System/Key code page (Figure B2).

Note: The key code is related to the instrument number, as displayed on the key code page. Please ensure that this instrument number has been noted before applying for a code or file.

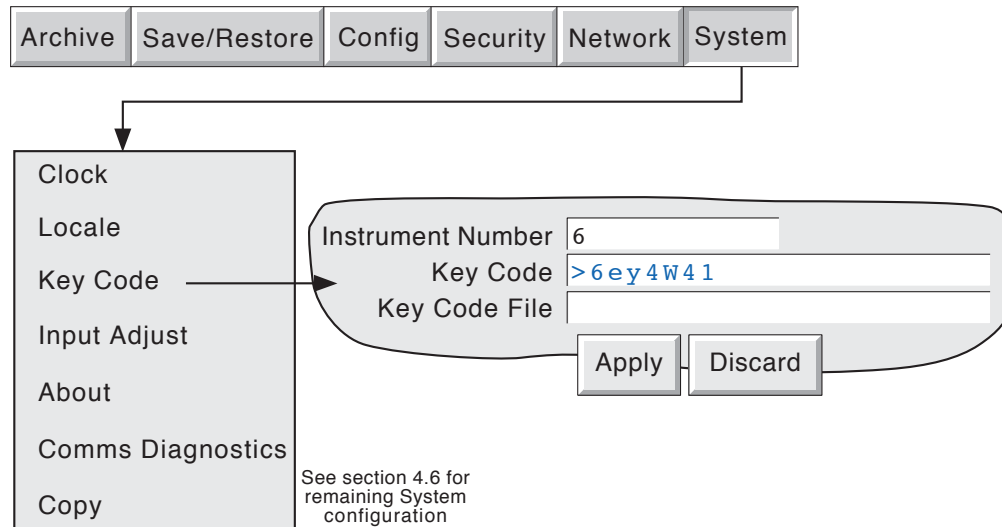

Figure B2 Option enable (key code) page

B2.1 INSTRUMENT NUMBER

This number, unique to each recorder, is used to identify the unit should any need arise for the user to contact the manufacturer or distributor of the instrument (if, for example, the user needs to enable one or more software options.)

B2.2 KEY CODE

Touching this field causes a qwerty style keyboard to appear, allowing the user to enter the key code received from the manufacturer or distributor. This is an alternative to loading the Key Code File described below.

B2.3 KEY CODE FILE

The key code may be sent to the user by, for example, e-mail. The key code can then be transferred from the PC to the recorder. Alternatively, the code can be entered manually as described above.

B3 COLOUR SELECTION

The following table, gives RGB values and decimal and hex numbers for the available channel colours. Normally, this table is necessary only when communicating over the Modbus link.





























| | Colour | Red | Green | Blue | Decimal | Hex |
|---|-------------|-----|-------|------|---------|-----|
|  | Red | 255 | 0 | 0 | 0 | 00 |
|  | Blue | 0 | 0 | 255 | 1 | 01 |
|  | Green | 0 | 255 | 0 | 2 | 02 |
|  | Honey | 255 | 191 | 0 | 3 | 03 |
|  | Violet | 170 | 321 | 153 | 4 | 04 |
|  | Russet | 170 | 95 | 0 | 5 | 05 |
|  | Dark Blue | 0 | 0 | 102 | 6 | 06 |
|  | Jade | 0 | 95 | 0 | 7 | 07 |
|  | Magenta | 255 | 0 | 102 | 8 | 08 |
|  | Dusky Rose | 255 | 95 | 51 | 9 | 09 |
|  | Yellow | 255 | 255 | 255 | 10 | 0A |
|  | Powder Blue | 85 | 63 | 255 | 11 | 0B |
|  | Dark Red | 170 | 0 | 0 | 12 | 0C |
|  | Avocado | 0 | 233 | 102 | 13 | 0D |
|  | Indigo | 85 | 0 | 102 | 14 | 0E |
|  | Dark Brown | 85 | 63 | 0 | 15 | 0F |
|  | Ægean | 0 | 63 | 51 | 16 | 10 |
|  | Cyan | 0 | 255 | 255 | 17 | 11 |
|  | Aubergine | 85 | 0 | 51 | 18 | 12 |
|  | Dark Orange | 255 | 63 | 0 | 19 | 13 |
|  | Pale Yellow | 255 | 255 | 51 | 20 | 14 |
|  | Hyacinth | 170 | 0 | 51 | 21 | 15 |
|  | Dark Green | 0 | 63 | 0 | 22 | 16 |
|  | Sugar Pink | 255 | 31 | 204 | 23 | 17 |
|  | Bluebell | 85 | 31 | 255 | 24 | 18 |
|  | Orange | 255 | 95 | 0 | 25 | 19 |
|  | Pink | 255 | 159 | 255 | 26 | 1A |
|  | Buttermilk | 255 | 255 | 102 | 27 | 1B |

Table B3, sheet 1: Colour definitions 0 to 27

B3 COLOUR SELECTION (Cont.)

























| | Colour | Red | Green | Blue | Decimal | Hex |
|---|-----------------------|-----|-------|------|---------|-----|
|  | Terracotta | 170 | 63 | 0 | 28 | 1C |
|  | Blue Babe | 85 | 95 | 255 | 29 | 1D |
|  | Lime | 0 | 223 | 0 | 30 | 1E |
|  | Blue Jive | 85 | 31 | 204 | 31 | 1F |
|  | Cucumber | 0 | 255 | 153 | 32 | 20 |
|  | EuroGreen | 67 | 107 | 103 | 33 | 21 |
|  | Wheatgerm | 255 | 223 | 51 | 34 | 22 |
|  | Sea Blue | 85 | 159 | 255 | 35 | 23 |
|  | Ginger | 255 | 159 | 0 | 36 | 24 |
|  | Aqua Pool | 0 | 63 | 255 | 37 | 25 |
|  | Pale Red | 255 | 63 | 51 | 38 | 26 |
|  | Pale Blue | 85 | 127 | 255 | 39 | 27 |
|  | Lilac | 170 | 0 | 255 | 40 | 28 |
|  | Sky Blue | 85 | 191 | 255 | 41 | 29 |
|  | Wild Moss | 0 | 127 | 0 | 42 | 2A |
|  | Turquoise | 0 | 127 | 153 | 43 | 2B |
|  | Pale Green | 85 | 255 | 153 | 44 | 2C |
|  | Coffee | 170 | 127 | 0 | 45 | 2D |
|  | Wicker | 255 | 255 | 191 | 46 | 2E |
|  | Black | 0 | 0 | 0 | 47 | 2F |
|  | Dark Dark Grey | 48 | 48 | 48 | 48 | 30 |
|  | Dark Grey | 64 | 64 | 64 | 49 | 31 |
|  | Grey | 128 | 128 | 128 | 50 | 32 |
|  | Light Light Dark Grey | 154 | 154 | 154 | 51 | 33 |
|  | Light Dark Grey | 172 | 172 | 172 | 52 | 34 |
|  | Light Grey | 192 | 192 | 192 | 53 | 35 |
|  | Light Light Grey | 212 | 212 | 212 | 54 | 36 |
|  | White | 255 | 255 | 255 | 55 | 37 |

Table B3, sheet 2: Colour definitions 28 to 55

B4 TCP PORT NUMBERS

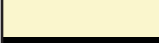
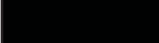
The following TCP ports are made use of by the unit. (This information would be needed by anyone involved in setting up 'firewalls', which may be used selectively to block incoming or outgoing access to specific ports.)

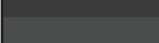
| PORT | Usage |
|-------|---|
| 20 | File Transfer Protocol - data |
| 21 | File Transfer Protocol - control |
| 25 | E-mail |
| 123 | SNTP server |
| 502 | Modbus/TCPIP communications |
| 1264 | Remote Viewer communications - general |
| 50010 | Remote Viewer communications - trend review |

B5 ASCII CHARACTERS FOR SERIAL COMMS

This section contains details of the ASCII characters that may be used with the Serial Comms option. All the ASCII characters listed can be used as Start or End-of-message characters, but only characters with decimal codes 32 to 127 can be used in messages, as decimal codes 0 to 31 are replaced by Question marks in messages.

| Character | Decimal | Hex | Character | Decimal | Hex | Character | Decimal | Hex | Character | Decimal | Hex |
|-----------|---------|-----|-----------|---------|-----|-----------|---------|-----|-------------|---------|-----|
| NUL | 0 | 00 | Space | 32 | 20 | @ | 64 | 40 | ' | 96 | 60 |
| SOH | 1 | 01 | ! | 33 | 21 | A | 65 | 41 | a | 97 | 61 |
| STX | 2 | 02 | " | 34 | 22 | B | 66 | 42 | b | 98 | 62 |
| ETX | 3 | 03 | # | 35 | 23 | C | 67 | 43 | c | 99 | 63 |
| EOT | 4 | 04 | \$ | 36 | 24 | D | 68 | 44 | d | 100 | 64 |
| ENQ | 5 | 05 | % | 37 | 25 | E | 69 | 45 | e | 101 | 65 |
| ACK | 6 | 06 | & | 38 | 26 | F | 70 | 46 | f | 102 | 66 |
| BEL | 7 | 07 | ' | 39 | 27 | G | 71 | 47 | g | 103 | 67 |
| BS | 8 | 08 | (| 40 | 28 | H | 72 | 48 | h | 104 | 68 |
| HT | 9 | 09 |) | 41 | 29 | I | 73 | 49 | i | 105 | 69 |
| LF | 10 | 0A | * | 42 | 2A | J | 74 | 4A | j | 106 | 6A |
| VT | 11 | 0B | + | 43 | 2B | K | 75 | 4B | k | 107 | 6B |
| FF | 12 | 0C | , | 44 | 2C | L | 76 | 4C | l | 108 | 6C |
| CR | 13 | 0D | - | 45 | 2D | M | 77 | 4D | m | 109 | 6D |
| SO | 14 | 0E | . | 46 | 2E | N | 78 | 4E | n | 110 | 6E |
| SI | 15 | 0F | / | 47 | 2F | O | 79 | 4F | o | 111 | 6F |
| DLE | 16 | 10 | 0 | 48 | 30 | P | 80 | 50 | p | 112 | 70 |
| DC1 | 17 | 11 | 1 | 49 | 31 | Q | 81 | 51 | q | 113 | 71 |
| DC2 | 18 | 12 | 2 | 50 | 32 | R | 82 | 52 | r | 114 | 72 |
| DC3 | 19 | 13 | 3 | 51 | 33 | S | 83 | 53 | s | 115 | 73 |
| DC4 | 20 | 14 | 4 | 52 | 34 | T | 84 | 54 | t | 116 | 74 |
| NAK | 21 | 15 | 5 | 53 | 35 | U | 85 | 55 | u | 117 | 75 |
| SYN | 22 | 16 | 6 | 54 | 36 | V | 86 | 56 | v | 118 | 76 |
| ETB | 23 | 17 | 7 | 55 | 37 | W | 87 | 57 | w | 119 | 77 |
| CAN | 24 | 18 | 8 | 56 | 38 | X | 88 | 58 | x | 120 | 78 |
| EM | 25 | 19 | 9 | 57 | 39 | Y | 89 | 59 | y | 121 | 79 |
| SUB | 26 | 1A | : | 58 | 3A | Z | 90 | 5A | z | 122 | 7A |
| ESC | 27 | 1B | ; | 59 | 3B | [| 91 | 5B | { | 123 | 7B |
| FS | 28 | 1C | < | 60 | 3C | \ | 92 | 5C | | 124 | 7C |
| GS | 29 | 1D | = | 61 | 3D |] | 93 | 5D | } | 125 | 7D |
| RS | 30 | 1E | > | 62 | 3E | ^ | 94 | 5E | ~ | 126 | 7E |
| US | 31 | 1F | ? | 63 | 3F | _ | 95 | 5F | Not printed | 127 | 7F |

Notes:

- 1 All the above characters can be used as Start or End-of-message characters (entered in decimal)
- 2 If characters 0 to 31 (00 to 1F) are used as message characters, they will be replaced by question marks on the screen.

B6 TIME ZONES

This section gives an explanation of the time zone abbreviations listed in the System/Locale/Time Zone pick list. The list starts at GMT, travelling Eastwards round the world.

| Abbreviation | Full title | Time at noon GMT | Hours of difference |
|--------------|--|------------------|---------------------|
| GMT | Greenwich mean time | 12:00 | 0 |
| UTC | Co-ordinated Universal time | 12:00 | 0 |
| ECT | Central European time | 13:00 | +1 |
| EET | Eastern European time..... | 13:00 | +1 |
| ART | Arabic standard time | 14:00 | +2 |
| EAT | Eastern African time..... | 15:00 | +3 |
| MET | Middle East time | 15:30 | +3.5 |
| NET | Near East time | 16:00 | +4 |
| PLT | Pakistan Lahore time..... | 17:00 | +5 |
| IST | India standard time..... | 17:30 | +5.5 |
| BST | Bangladesh standard time..... | 18:00 | +6 |
| VST | Vietnam standard time | 19:00 | +7 |
| CTT | China Taiwan time | 20:00 | +8 |
| JST | Japan standard time..... | 21:00 | +9 |
| ACT | Australia Central time | 21:30 | +9.5 |
| AET | Australia Eastern time..... | 22:00 | +10 |
| SST | Solomon standard time..... | 23:00 | +11 |
| NST | New Zealand standard time | 24:00 | +12 |
| MIT | Midway Islands time | 01:00 | -11 |
| HST | Hawaii standard time..... | 02:00 | -10 |
| AST | Alaska standard time | 03:00 | -9 |
| PST | Pacific standard time | 04:00 | -8 |
| PNT | Phoenix standard time | 05:00 | -7 |
| MST | Mountain standard time..... | 05:00 | -7 |
| CST | Central standard time..... | 06:00 | -6 |
| EST | Eastern standard time | 07:00 | -5 |
| IET | Indiana Eastern standard time | 07:00 | -5 |
| PRT | Puerto Rico and US Virgin Islands time | 08:00 | -4 |
| CNT | Canada Newfoundland time | 08:30 | -3.5 |
| AGT | Argentina standard time | 09:00 | -3 |
| BET | Brazil Eastern time | 09:00 | -3 |
| CAT | Central African time | 11:00 | -1 |

B7 JOB TRIGGER LIST

Even with simple configurations, it is easy to lose track of which trigger initiates which job. Tables similar to those may be found useful in recording job triggers sources) during configuration.

Sheet 1

| | JOB | Source 1 | Source 2 | Details | Superseded by job no. |
|-----------------|--------------------------------------|-------------------------------|-----------------|--|------------------------------|
| No. 1 | Relay 1, Board 1 (overload alarm) | Channel 16, Alarm 1, Job 1 | Event 2 | Time/date 3/12/03 12:30 Operator Andy | |
| 2 | | | | Time/date Operator | |
| 3 | | | | Time/date Operator | |
| 4 | | | | Time/date Operator | |
| 5 | | | | Time/date Operator | |
| 6 | | | | Time/date Operator | |
| 7 | | | | Time/date Operator | |
| 8 | | | | Time/date Operator | |
| 9 | | | | Time/date Operator | |
| 10 | | | | Time/date Operator | |
| 11 | | | | Time/date Operator | |
| 12 | | | | Time/date Operator | |
| 13 | | | | Time/date Operator | |
| 14 | | | | Time/date Operator | |
| 15 | | | | Time/date Operator | |

B7 JOB TRIGGER LIST (Cont.)

Sheet

| JOB | | Source 1 | Source 2 | Details | Superseded by job no. |
|------------|----------|-----------------|-----------------|----------------|----------------------------------|
| No. | Category | Trigger 1 | Trigger 2 | Time/date | |
| | | | | Operator | |
| | | | | Time/date | |
| | | | | Operator | |
| | | | | Time/date | |
| | | | | Operator | |
| | | | | Time/date | |
| | | | | Operator | |
| | | | | Time/date | |
| | | | | Operator | |
| | | | | Time/date | |
| | | | | Operator | |
| | | | | Time/date | |
| | | | | Operator | |
| | | | | Time/date | |
| | | | | Operator | |
| | | | | Time/date | |
| | | | | Operator | |
| | | | | Time/date | |
| | | | | Operator | |
| | | | | Time/date | |
| | | | | Operator | |
| | | | | Time/date | |
| | | | | Operator | |

B8 MENU STRUCTURE

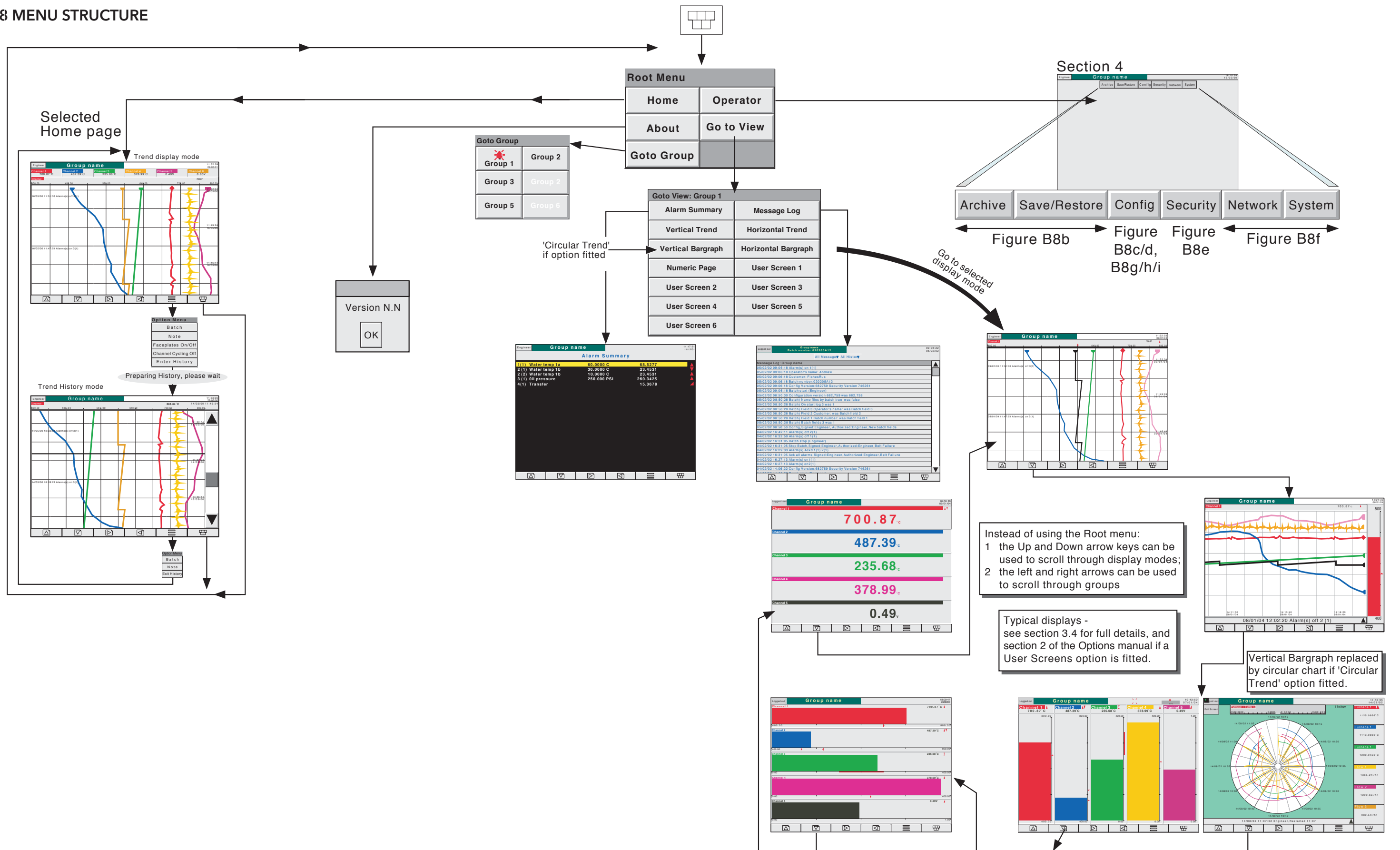

Figure B8a Menu structure sheet 1 (Root menu)

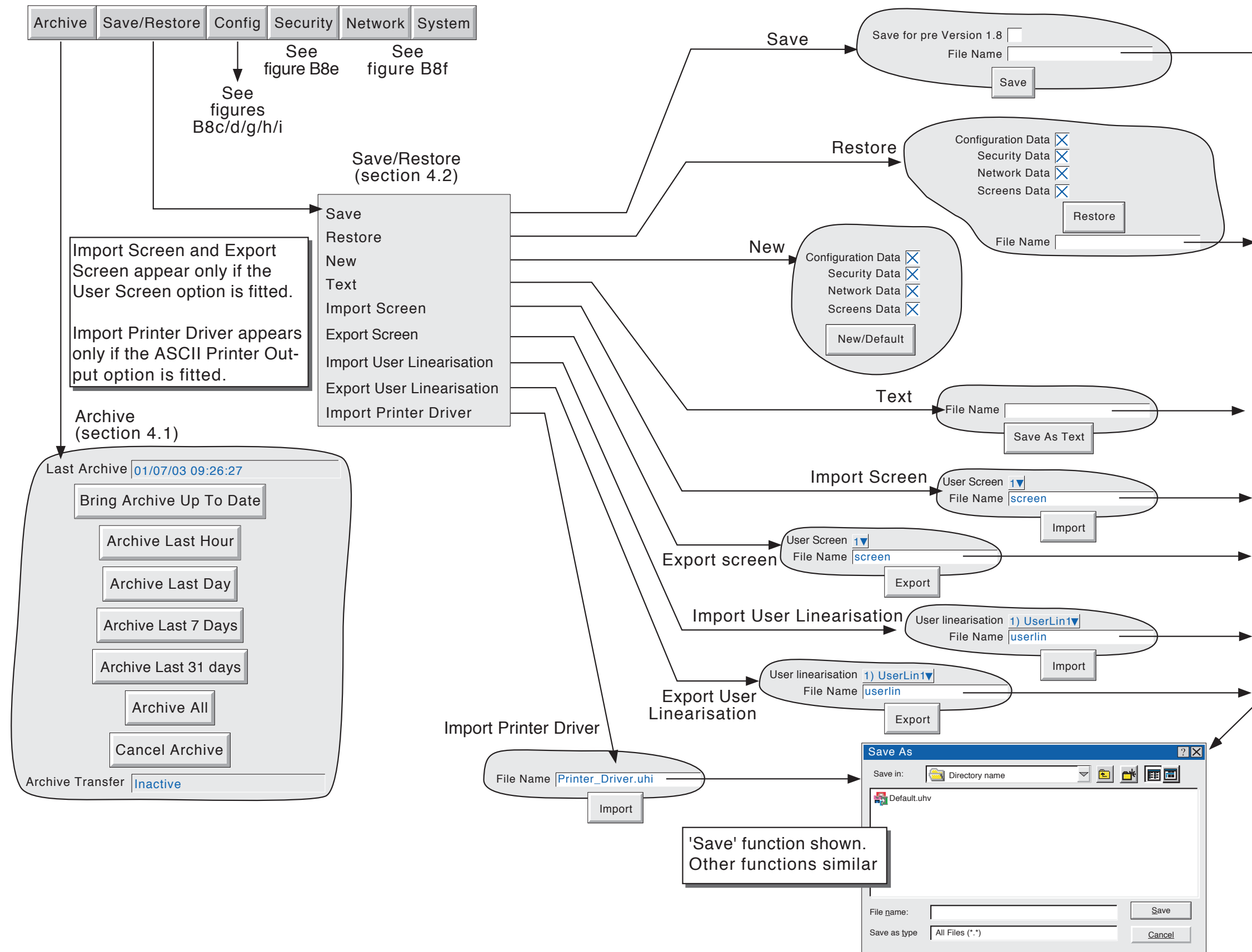

Figure B8b Menu structure sheet 2 (Archive and Save/Restore menus)

B8 MENU STRUCTURE (Cont.)

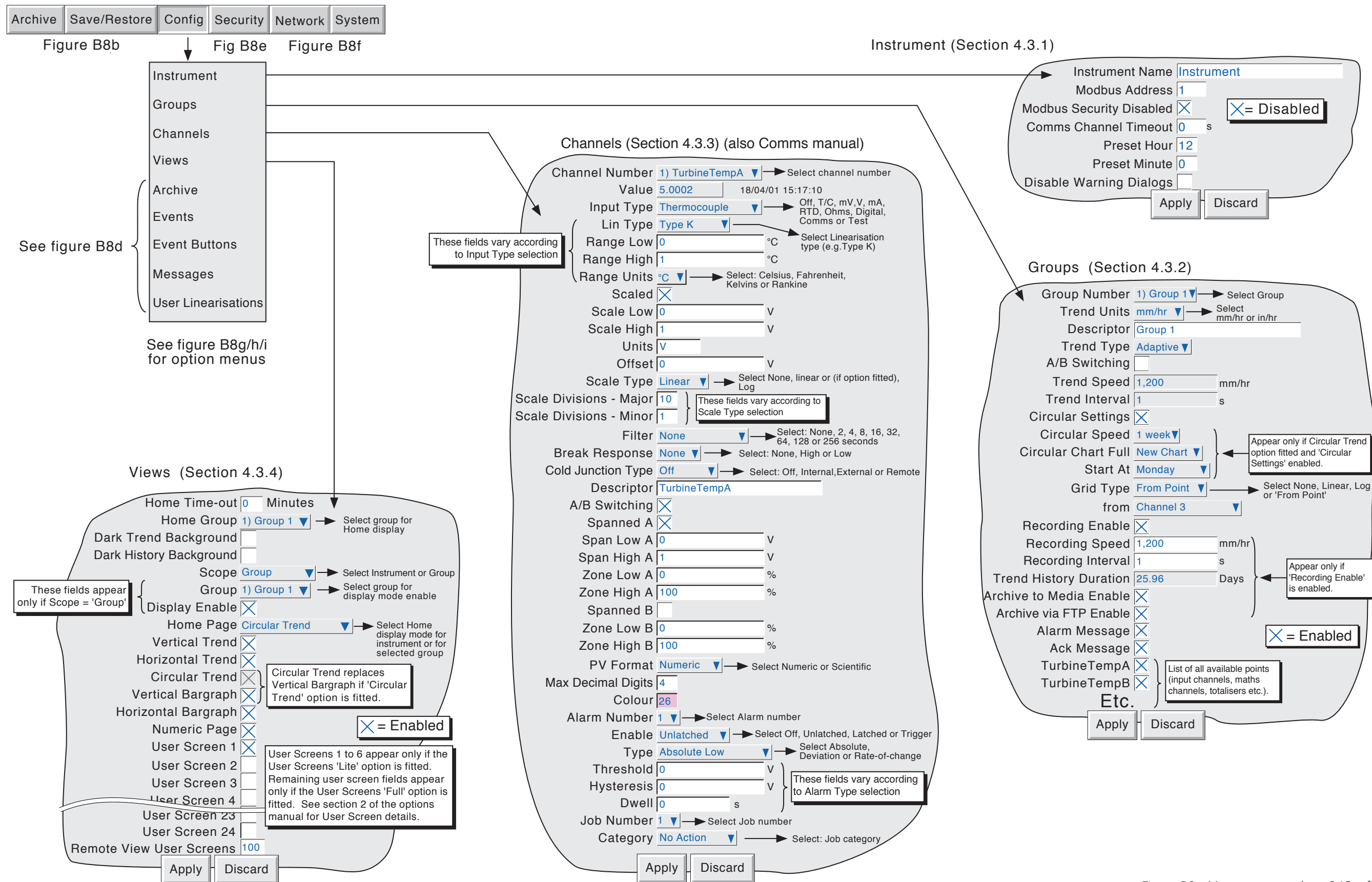

Figure B8c Menu structure sheet 3 (Config menus 1)

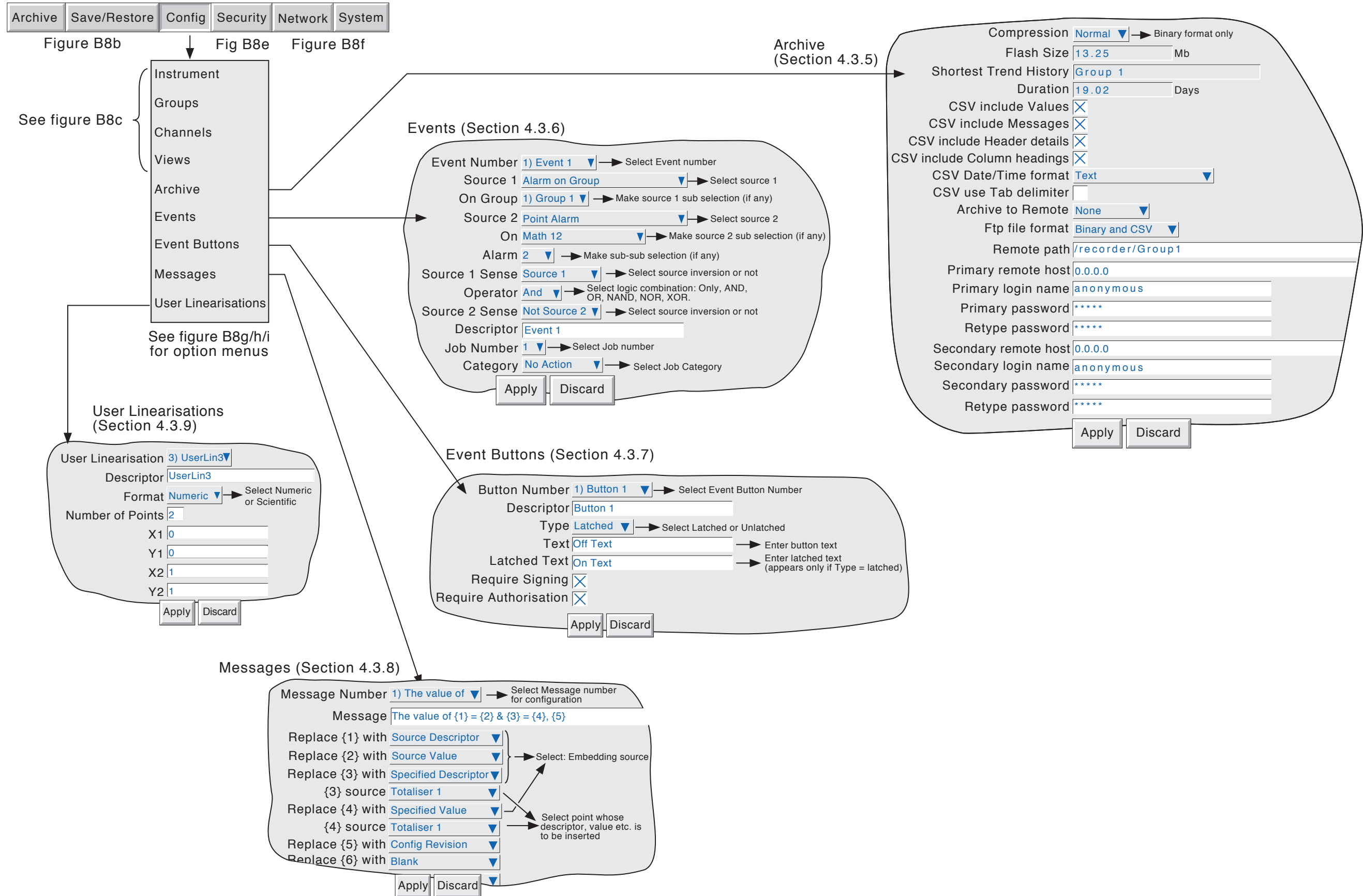

Figure B8d Menu structure sheet 4 (Config menus 2)

B8 MENU STRUCTURE (Cont.)

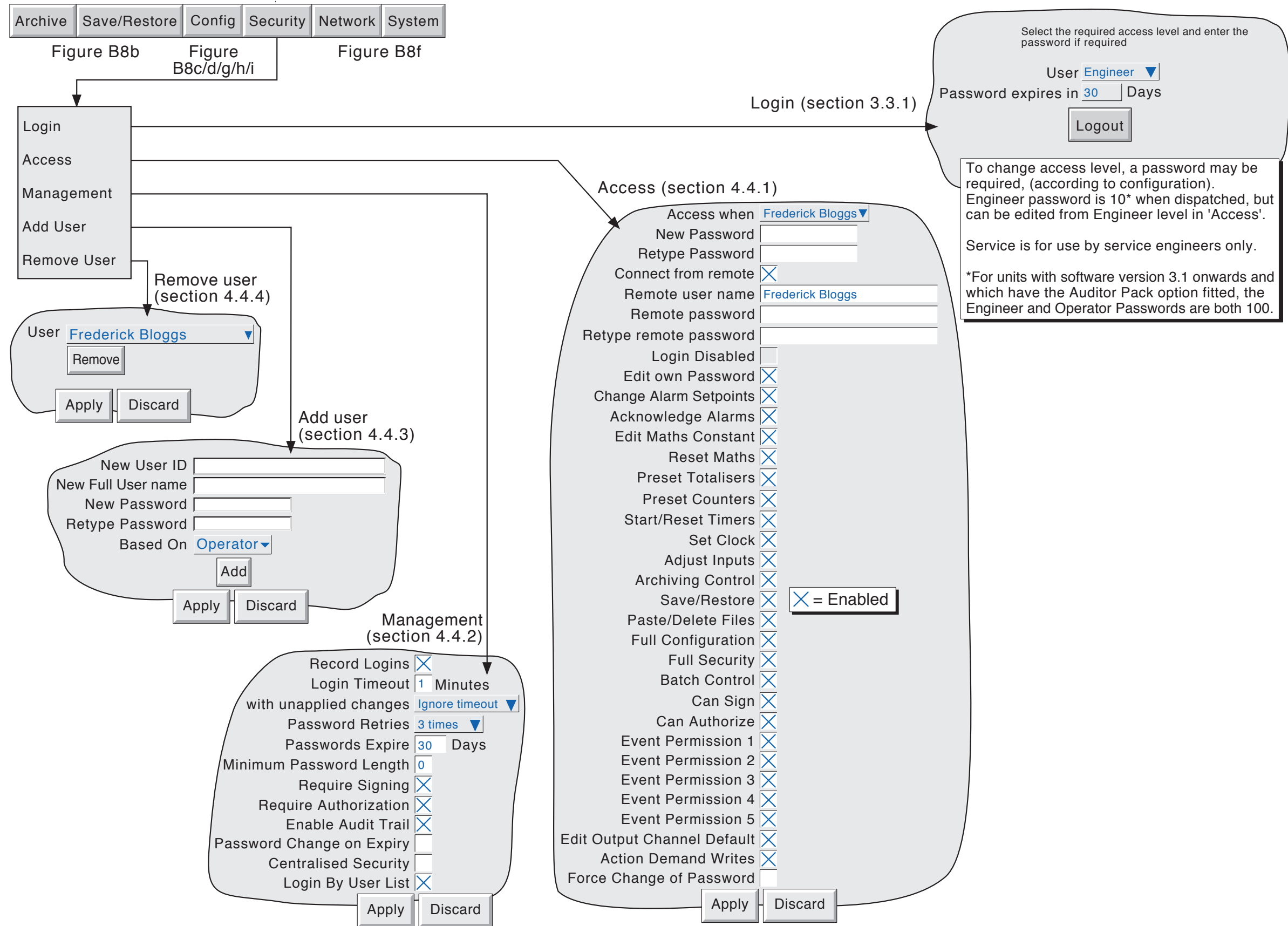

Figure B8e Menu structure sheet 5 (Security menus)

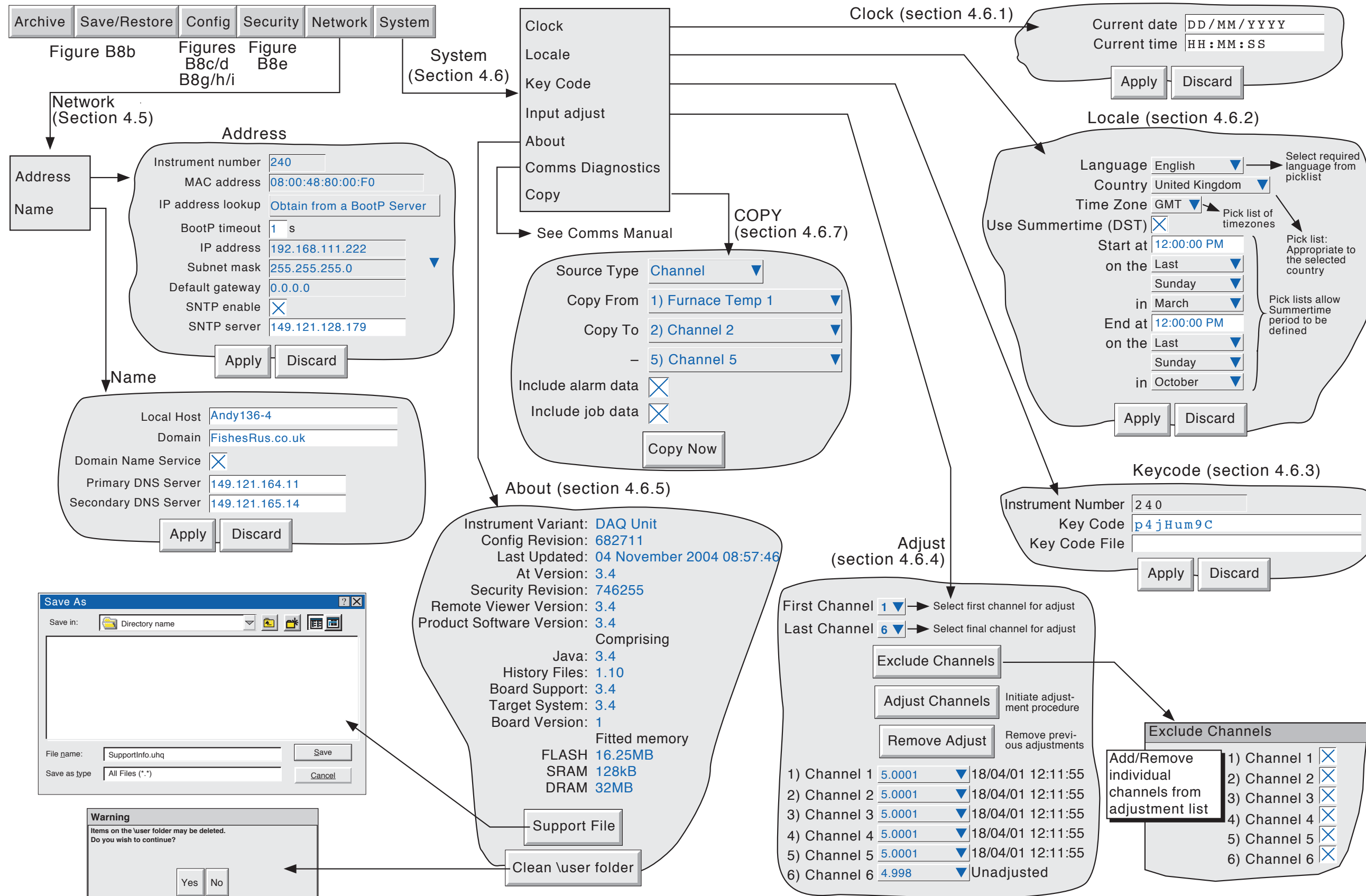

Figure B8f Menu structure sheet 6 (Network and System menus)

B8 MENU STRUCTURE (Cont.)

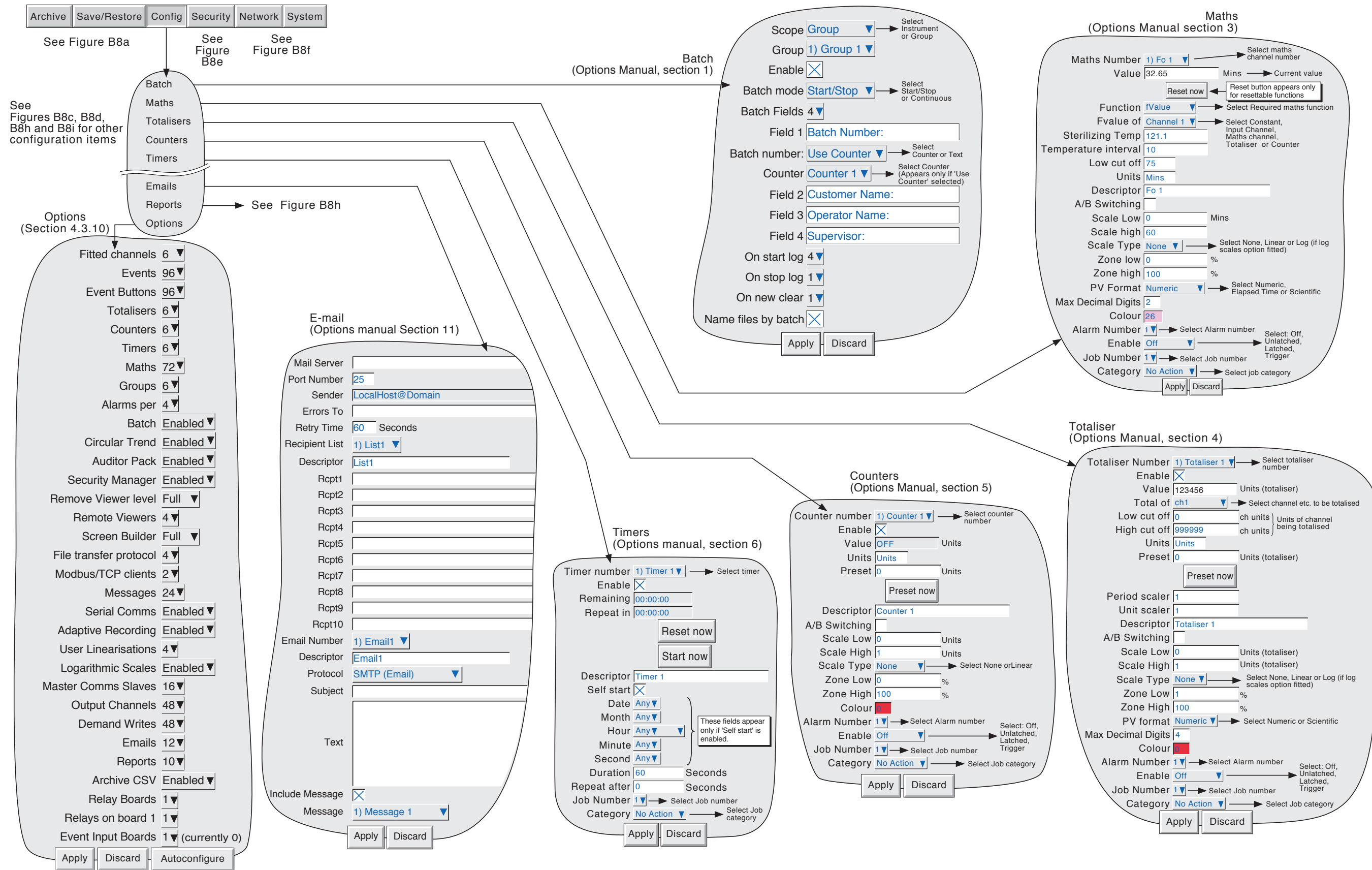

Figure B8g Menu structure sheet 7 (Options menus 1)

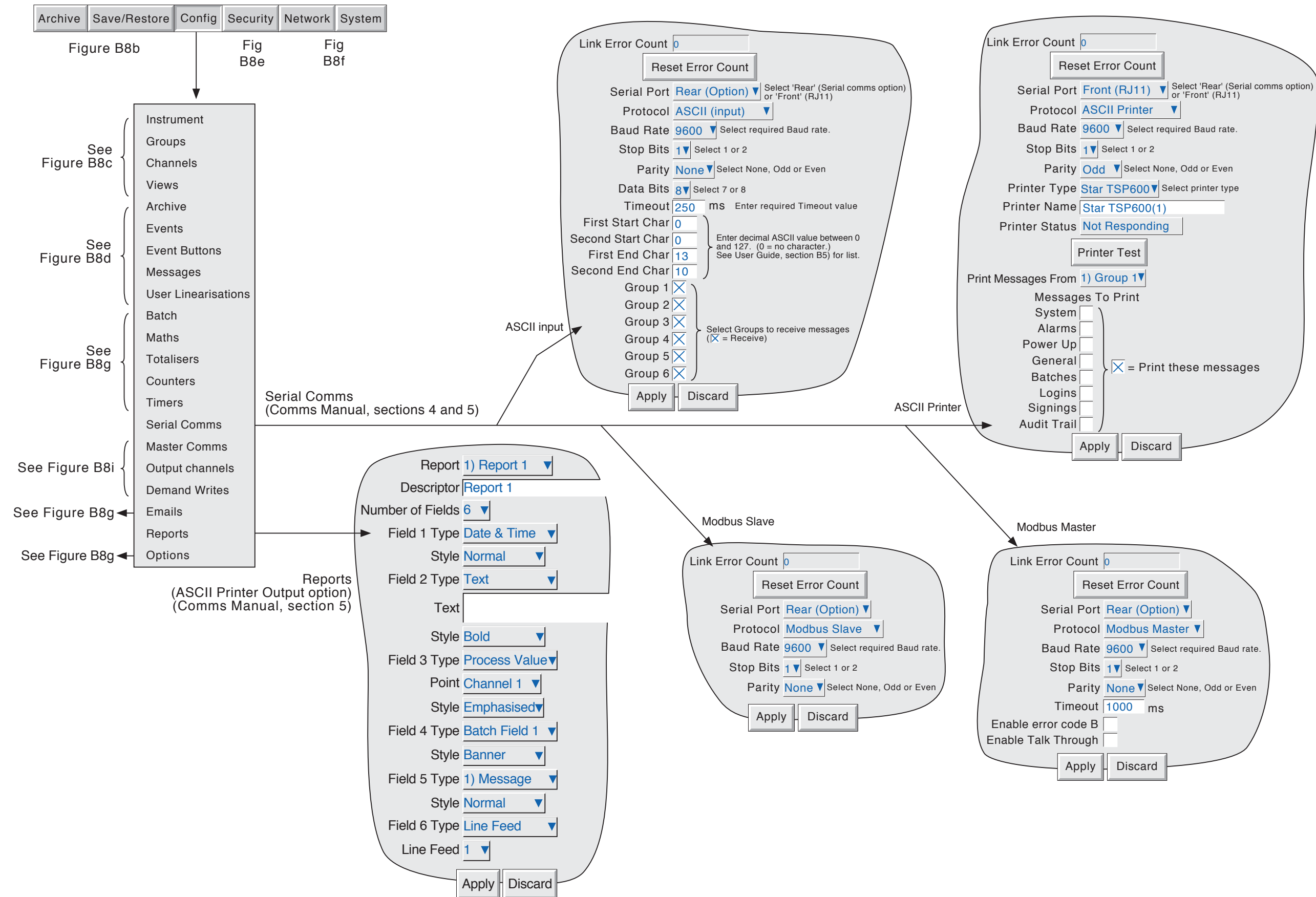

Figure B8h Menu structure sheet 8 (Options menu 2)

B8 MENU STRUCTURE (Cont.)

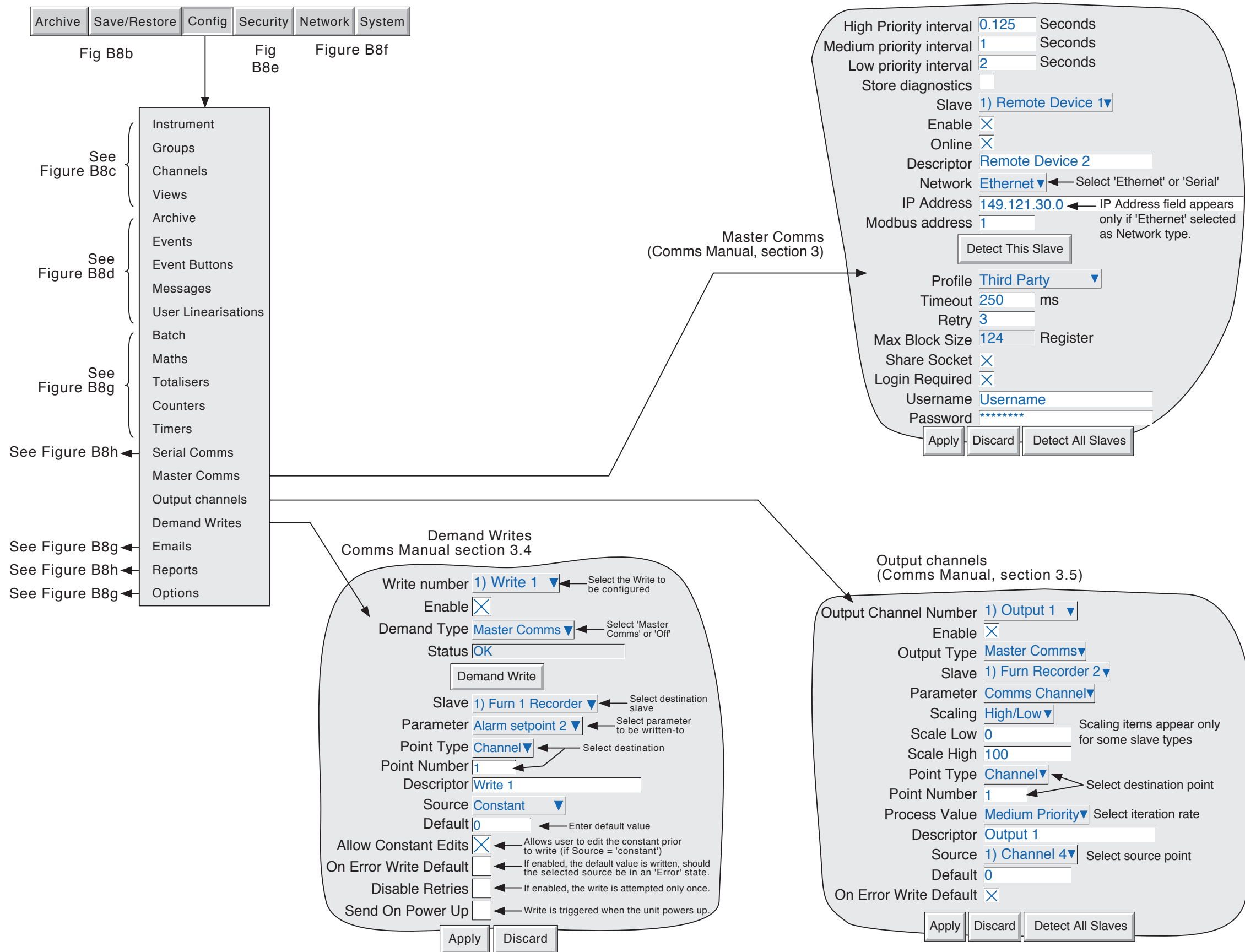

Figure B8i Menu structure sheet 9 (Master comms option)

This page is deliberately left blank

INDEX

Symbols

| | |
|----------------------------|--------|
| ????? in message | 87, 88 |
| {n} source. | 87 |
| .uhq file. | 111 |

A

| | |
|---|--------|
| About. | 110 |
| Absolute high/low | 72 |
| A/B Switching | 63, 70 |
| Access | |
| Levels | 94 |
| To configuration | 33 |
| when. | 95 |
| ACK Message | 65 |
| Acknowledge alarms. | 26 |
| Permission. | 95 |
| Action Demand Writes permission | 97 |
| Adaptive recording | 62 |
| Address | |
| IP 103 | |
| MAC | 103 |
| Add User | 102 |
| Adjust channels | 108 |
| Adjust inputs permission. | 96 |
| Alarm | |
| Acknowledge | |
| Permission | 95 |
| Acknowledgement. | 26 |
| Message enable/disable | 65 |
| Configuration | 72 |
| Enable | 72 |
| Icons (Channel). | 24 |
| Indicators | 25 |
| Jobs | 120 |
| Message enable/disable | 65 |
| Messages | 75 |
| Number | 72 |
| Summary page | 25 |
| Type | 72 |
| Illustrations | 74 |
| Alarm on Group Event Source. | 83 |
| Amount (R of C alarms). | 73 |
| AND. | 85 |
| Archive | |
| Archive failed instrument alarm | 27 |
| Configuration. | 79 |
| Control permission. | 96 |
| File formats | 81 |
| Jobs | 120 |
| Key | 53 |
| Manual initiation to host. | 52 |
| Suspend. | 52 |
| To Remote. | 80 |
| via FTP. | 65 |
| ASCII codes | 135 |
| At version | 110 |
| Audit | |
| Pack option | 98 |
| Trail. | 100 |
| Authorize permission. | 97 |
| Average time | 73 |

B

| | |
|--------------------------------------|-----|
| Bargraph | |
| Displays | |
| Horizontal | 43 |
| Vertical | 41 |
| Based on | 102 |
| Batch | |
| Batch Running Event Source | 83 |
| Control access permission | 96 |
| Jobs | 117 |
| Start | 117 |
| Event source | 83 |
| Battery | |
| Icon | 27 |
| Replacement | 129 |
| Battery backed RAM cleared. | 27 |
| Battery backed RAM data | 125 |
| Battery Low (Event Source). | 84 |
| Blue line across the chart. | 37 |
| BootP timeout | 103 |
| Break response | 70 |
| BSpC | 34 |

C

| | |
|--|----------|
| Cable | |
| Signal, Max/min sizes | 12 |
| Supply voltage (max. length) | 12 |
| Supply voltage (min. size). | 12 |
| Can | |
| Authorize | 97 |
| Sign | 96 |
| Caps | 34 |
| Centralised security. | 101 |
| Change | |
| Alarm setpoint permission | 95 |
| Battery | |
| Procedure | 129 |
| Constant value | 95 |
| Change time (R of C alarms). | 73 |
| Channel | |
| Alarm indicator | 27 |
| Colour | 71 |
| Configuration. | 66 to 92 |
| Copy. | 112 |
| Cycling on/off. | 36 |
| Damping | 70 |
| Descriptor | 70 |
| Instrument alarms | 27 |
| Character set | |
| Keyboards. | 34 |
| Serial comms | 135 |
| Chart grid type/divisions. | 64 |
| Chart speed (Circular) | 63 |
| Circular Chart | |
| Chart Full operation | 63 |
| Speed | 63 |
| Start At. | 63 |
| Circular Settings. | 63 |
| Circular Trend option | 47 |
| CJC | 70 |
| Clean \user folder. | 111 |

C (Cont.)

Clock
 Accuracy 125
 Clock failure instrument alarm 27
 Preset
 Job 116
 Setting 107
 Cold junction compensation. 70
 Colour
 Channel. *See also* Annex B
 Colour B select job. 118
 Comms
 Channel timeout 83
 Timeout 60
 Config Revision 32, 110
 Configuration 57
 A/B Switching. 63, 70
 Access 33
 Alarm 72
 Amount. 73
 Average time. 73
 Change time 73
 Deviation value 73
 Dwell period 73
 Hysteresis. 73
 Reference value 73
 Threshold. 73
 Type. 72
 Archive. 79
 Audit pack. 98
 Break response 70
 Channel / Alarm 66 to 92
 Cold junction compensation 70
 Country 107
 Date format 107
 Decimal point. 71
 Event. 83
 Buttons 86
 Filter 70
 Group 61
 Input low/high 67
 Language 107
 Linearisation range. 68
 Linearisation type 67
 Locked. 28
 Management 98
 Network 103
 Offset 68
 Options 92
 Scale 68
 Security 93
 Shunt value 67
 Spanned. 71
 Summertime 107
 Time and date 107
 Time zone 107
 Trace Colour 71
 Views. 76
 Zone 71
 Configuration Locked indicator 28
 Connect from Remote 95
 Contents of group. 65

C (Cont.)

Copy facility 112
 Copy From 112
 Counter
 Copy 112
 Jobs 117
 Country, Selection of. 107
 CSV
 Date/Time format 82
 Use Tab delimiter. 82
 Cursor keys. 28
 Cycle channels on/off. 36
D
 Damping 70
 Dark Background 76
 Data
 Compression ratio 79
 Date
 Format 107
 Setting 107
 Daylight saving setup. 107
 Decimal point position 71
 Decrement counter job. 117
 Default Gateway. 104
 Demand
 Write
 Copy 112
 Jobs. 119
 Permission 97
 Descriptor
 Channel 70
 Event. 85
 Group 24, 62
 Instrument. 60
 Deviation alarms. 72
 Disable
 Counter 117
 Login. 95
 Maths channel 116
 Timer. 117
 Totaliser 115
 Disable Warning Dialogues 60
 Display
 Mode 35
 Enable/disable. 76
 Home selection 76
 Horizontal Bars. 43
 Horizontal Trend. 39
 Numeric 45
 Select 29
 Vertical bars 41
 Vertical Trend 36
 Update rate 125
 Values (truncation of) 23
 Domain 105
 Name Service. 105
 Drive Relay Job 114
 Dwell 73
E
 Earlier messages.. 31
 Electrical installation 12

E (Cont.)

E-mail
 Jobs 121
 Enable
 Audit trail 100
 Display modes 77
 Options 131
 Engineer, Access level 32, 94
 Error messages
 FTP 18
 Event
 Buttons 86
 copy 112
 Permission 97
 Source 83
 Source 1 sense 84
 Source sense 85
 Event configuration 83
 Exclamation mark symbol 27
 Exclude Channels 108
 Export
 Screen 55
 User linearisation 56
 External CJ 70

F

File formats (archiving) 81
 File Transfer (FTP) facility 52
 Filter 70
 First/Last channel 108
 First switch-on 32
 Flash size 79
 Folder keys 28
 Force change of password 97
 FTP file format 81
 FTP Icon 28
 Full Configuration permission 96
 Full Screen 49
 Full Security permission 96
 Full user name 102

G

General Specification 124
 Global Alarm Event Source 83
 Global Unack'd Alarm Event Source 83
 Go to
 Group key 29
 View key 29
 Green line across the chart 37
 Grid
 Type/Divisions 64
 Group
 Configuration 61
 Contents 65
 Copy 112
 Display enable 77
 Display modes 77
 Enable/disable 64
 Home 76
 Name 24, 62
 Report destination 121
 Select 29

H

Hardware version 110
 History
 Amount of 37, 65
 Maximum history 37
 Home
 Group 76
 Page (Display mode) 77
 Timeout 76
 Horizontal
 Bargraph enable 77
 Trend enable 77
 Trend mode 39
 Hysteresis 73

I

Import
 Screen 55
 User linearisation 56
 Include alarm data 112
 Include job data 112
 Increment counter job 117
 Input
 Adjust 107
 Permission 96
 Board specification 126
 Configuration 67
 Low/high 67
 Type selection 67
 Installation
 Category 123
 Electrical 12
 Mechanical 10
 Instrument
 Alarm
 Event source 84
 Summary 25
 Alarm indicator 27
 Name 60
 Number 103
 Variant 110
 Insufficient non-volatile memory... (instrument al 27
 Internal CJ 70
 Internal flash instrument alarm 27
 Interval (recording) 65
 Invalid Password Entry 84
 IP Address 103
 Look-up 103
 Manual entry 103

J

Jobs 114
 Alarm Acknowledge/Disable 120
 Archive 120
 Batch 117
 Clock 116
 Counter 117
 Demand writes 119
 E-mail 121
 Event 85
 Input channel 75
 Maths 116
 Output 119

Jobs (Cont.)

Recording 118
 Report 121
 Timer. 117
 Trend. 118

K

Keycode 107
 Key Code (File) 131

L

Labelling symbols. 9
 Language selection 107
 Last Updated. 110
 Latched. 72
 Later messages... 31
 Left key 28
 Line across the chart 37
 Linear chart grid 64
 Linearisation function. 67
 User entered 90
 Linear scales 69
 Locale. 107
 Local Host 105
 Lockout recovery 22
 Log
 Chart grid 64
 Scale 69
 Logged out 32
 Login 33, 101
 Disable. 95
 Timeout 98
 Logout key 93
 Low/High Point 109

M

MAC Address 103
 Maintenance 129
 Major circular chart divisions 63
 Management 98
 Manual archive 52
 Maths
 Copy 112
 Maths channel
 Jobs 116
 Maths Channel Partial Failure 84
 Memory size 79, 110
 Menu structure
 Archive Key 140
 Config menus. 141, 142, 146
 Network and System. 144
 Options 145, 147
 Root menu 139
 Save/Restore Key. 140
 Security 143
 Message 87
 Alarm 75
 Copy 112
 Enable/disable 65
 Entry 87
 Example 89
 Jobs 115
 Log. 30

Message (Cont.)

Operator entered 51
 Power up 32
 Minimum
 Password Length 99
 PC requirements 13
 Min-Max recording 62
 Modbus
 Address setting. 60
 Master, jobs. 119
 Security disable. 60

N

NAND. 85
 Navigation keys 28
 Network
 Configuration 103
 Configuration port 19
 Name 105
 Settings 21
 New
 Configuration 55
 Password 95
 New Chart 47, 63
 New Full User Name 102
 New user ID 102
 No action. 114
 No chart grid. 64
 NONE. 85
 NOR. 85
 Normal View 48
 Numeric
 Display. 71
 Display mode enable 77
 Numeric display mode 45

O

Off. 72
 Offset 68
 Ok. 34
 On becoming active/inactive/acknowledged 114
 Operator
 Access level 32, 94
 Event logic 85
 Key 29
 Notes (Messages) 51
 Option
 Configuration 92
 Key 28
 OR. 85
 Output
 Channel
 Default editing. 97
 Copy 112
 Jobs 119
 Ovr 34

P

Page up/down keys 28
 Panel installation 10
 Paper Low/Paper Out. 27

P (Cont.)

Password 94
 Change on expiry 101
 Editing 93
 Expiry 99
 Force change of 97
 Retries 99
 Point Alarm 83
 Pollution degree 123
 Power-up
 Event source 84
 Message 32
 Preset
 Clock Job 116
 Counter 117
 Permission 96
 Hour/ Minute 60
 Totaliser
 Job 115
 Permission 96
 Preventive maintenance 129
 Primary
 DNS Server 105
 Login Name 80
 Remote Host 80
 Printed keys 28
 Printer not Responding 27
 PV Format 71

Q

Question marks in message 87

R

Range low/high/units 68
 Recorder
 Configuration. *See* Section 4.3
 Serial Number 131
 Synchronisation (SNTP) 104
 Recording
 Enable/disable 64
 Enable/Disable 118
 Interval 65
 Jobs 118
 Speed 65
 Speed B job 118
 Recording failed instrument alarm 27
 Record logins 98
 Red line across the chart 37
 Reference value 73
 Relay
 Board specification 128
 Drive relay job 114
 Remote
 Path 80
 User name/password 95
 Remote Cold Junction Compensation 70
 Remote viewer
 Configuration
 Access menu 17
 Network menu 103
 Options menu 17
 Connection details 14
 Minimum PC requirements 13

Remote viewer (Cont.)

Running the program 15
 Software installation 15
 Remove user 102
 Replace {n} with 87
 Report job 121
 Require Authorization/Signing 86, 99
 Reset
 Maths
 Permission 96
 Maths channel 116
 Timer 117
 Permission 96
 Restore 55
 Right key 28
 Root key 28
 Rotate 63
 Rotate (Chart) 47
 RTD
 Specifications 127
 Type selection 67

S

Safety notes 9
 Sample rates 125
 Save for Pre version 1.8. 54
 Save/Restore 54
 Permission 96
 Scale
 Divisions (Major/Minor) 69
 Type 69
 Scaled tick box 68
 Scientific display 71
 Scope, Display modes 76
 Screen, Importing/Exporting 55
 Secondary
 DNS Server 105
 Login 80
 Password 80
 Remote Host 80
 Security
 Configuration 93
 Levels 94
 Revision 32, 101, 111
 Select
 Display mode 29
 Group 29
 Send Report to 121
 Serial communications spec. 125
 Service level access 32
 Set clock permission 96
 Setting IP Address 21
 Setting the time and date 107
 Shift 34
 Shortest trend history 79
 Shunt value entry 67
 Signal Wiring 12
 Sign permission 96
 SNTP 104
 Instrument alarm 27
 Time server 10
 Software upgrade 22
 Software version 110

S (Cont.)

Source 1 sense 84
 Source 2 sense 85
 Source descriptor/value 87
 Source Type 112
 Source Types. 83
 Span B select job 118
 Spanned Configuration. 71
 Specification
 Battery 125
 DAQ unit, general 124
 Input board 126
 Relay board 128
 RTC. 125
 Serial comms board 125
 Specified descriptor/value. 87
 Speed
 Speed/interval B job 118
 Speed (of recording) 65
 Start timer permission 96
 Status bar. 24
 Subnet Mask 103
 Summary page (Alarm). 25
 Summertime setup 107
 Supply voltage. 12
 Supply voltage range. 12
 Support file. 111
 Suspend Archiving 53
 Symbols used on labels 9
 Synchronisation by SNTP. 104
 System configuration 106

T

Tag, Channel. 70
 Text
 Save and Restore. 55
 String entry 34
 There appears to be no free disk space... 13, 18
 Thermocouple
 Types and ranges. 127
 Type selection 67
 Threshold 73
 Time
 Change annotation. 37
 Format 107
 Permission to set 96
 Setting. 107
 Synch. instrument alarm. 27
 Synchronisation (SNTP) 104
 Zone selection 107
 Timeout. 76
 Comms channel 60
 Timer
 Jobs 117
 Start/Reset Permission 96
 Timer Active Event Source 83
 Timer, Copy 112
 Timestamps (circular chart) 50
 Tme synchronisation failure 27
 Totaliser
 Copy 112
 Jobs 115

Trend (Cont.)

Trend
 Circular (option) 47
 Colour 71
 History display 37, 65
 History, maximum 65
 History (shortest) 79
 Interval/Speed/Units. 62
 Jobs 118
 Speed/interval 63
 Trend speed/interval B job 118
 Type 62
 Trigger 72
 Truncation of display values 23

U

Un'ackd Alarm on group 84
 Unack'd point alarm 83
 Unlatched 72
 Unpacking the unit 10
 Unsupported File message 54
 User
 Adding and removing 102
 Linearisation table
 Configuration 90
 Importing/Exporting 56
 Password 102
 Screens, Number of 78
 User linearisation table
 Units selection 68
 User logged in Event Source 84
 User login account disabled. 84
 User name (full) 102

V

Value entry 34
 Version numbers 110
 Vertical
 Bargraph display 41
 Bargraph mode enable 77
 Trend mode. 36
 Trend mode enable 77
 Views configuration. 76

W

Whilst active/inactive/unacknowledged 114
 Wiring
 Signal 12
 Maximum torque 12
 Max/min wire sizes 12
 Supply voltage 12
 with unapplied changes 98

X

XOR. 85

Y

You are already running ... message 13, 18
 You are authenticating Full Remote Viewer... 13, 18

Z

Zone B select job 118
 Zone configuration 71

Eurotherm: International sales and service

AUSTRALIA Melbourne

Invensys Process Systems Australia Pty. Ltd.
Telephone (+61 2) 9838 0099
Fax (+61 2) 9838 9288
E-mail info.eurotherm.au@invensys.com

AUSTRIA Vienna

Eurotherm GmbH
Telephone (+43 1) 798 7601
Fax (+43 1) 798 7605
E-mail info.eurotherm.at@invensys.com

BELGIUM & LUXEMBOURG Moha

Eurotherm S.A/N.V.
Telephone (+32) 85 274080
Fax (+32) 85 274081
E-mail info.eurotherm.be@invensys.com

BRAZIL Campinas-SP

Eurotherm Ltda.
Telephone (+5519) 3112 5333
Fax (+5519) 3112 5345
E-mail info.eurotherm.br@invensys.com

CHINA

Eurotherm China
Shanghai Office
Telephone (+86 21) 6145 1188
Fax (+86 21) 6145 2602
E-mail info.eurotherm.cn@invensys.com
Beijing Office
Telephone (+86 10) 5909 5700
Fax (+86 10) 5909 5709/10
E-mail info.eurotherm.cn@invensys.com

FRANCE Lyon

Eurotherm Automation SA
Telephone (+33 478) 66 45 00
Fax (+33 478) 35 24 90
E-mail info.eurotherm.fr@invensys.com

GERMANY Limburg

Invensys Systems GmbH
Telephone (+49 6431) 2980
Fax (+49 6431) 298119
E-mail info.eurotherm.de@invensys.com

INDIA Mumbai

Invensys India Pvt. Ltd.
Telephone (+91 22) 67579800
Fax (+91 22) 67579999
E-mail info.eurotherm.in@invensys.com

IRELAND Dublin

Eurotherm Ireland Limited
Telephone (+353 1) 469 1800
Fax (+353 1) 469 1300
E-mail info.eurotherm.ie@invensys.com

ITALY Como

Eurotherm S.r.l
Telephone (+39 031) 975111
Fax (+39 031) 977512
E-mail info.eurotherm.it@invensys.com

KOREA Seoul

Invensys Operations Management Korea
Telephone (+82 2) 2090 0900
Fax (+82 2) 20900800
E-mail info.eurotherm.kr@invensys.com

NETHERLANDS Alphen a/d Rijn

Eurotherm B.V.
Telephone (+31 172) 411752
Fax (+31 172) 417260
E-mail info.eurotherm.nl@invensys.com

POLAND Katowice

Invensys Eurotherm Sp z o.o
Telephone (+48 32) 7839500
Fax (+48 32) 7843608/77843609
E-mail info.eurotherm.pl@invensys.com

Warsaw Office

Invensys Systems Sp z o.o.
Telephone (+48 22) 8556010
Fac (+48 22) 8556011
E-mail biuro@invensys-systems.pl

SPAIN Madrid

Eurotherm España SA
Telephone (+34 91) 661 6001
Fax (+34 91) 661 9093
E-mail info.eurotherm.es@invensys.com

SWEDEN Malmo

Eurotherm AB
Telephone (+46 40) 384500
Fax (+46 40) 384545
E-mail info.eurotherm.se@invensys.com

SWITZERLAND Wollerau

Eurotherm Produkte (Schweiz) AG
Telephone (+41 44) 787 1040
Fax (+41 44) 787 1044
E-mail info.eurotherm.ch@invensys.com

UAE Dubai

Invensys Middle East FZE
Telephone (+971 4) 8074700
Fax (+971 4) 8074777
E-mail marketing.mena@invensys.com

UNITED KINGDOM Worthing

Invensys Eurotherm Limited
Telephone (+44 1903) 268500
Fax (+44 1903) 265982
E-mail info.eurotherm.uk@invensys.com

U.S.A Ashburn VA

Invensys Eurotherm
Telephone (+1 703) 724 7300
Fax (+1 703) 724 7301
E-mail info.eurotherm.us@invensys.com

ED69

©Copyright Eurotherm Limited 2012

Invensys, Eurotherm, the Invensys Eurotherm logo, Chessell, EurothermSuite, Mini8, EPower, Eycon, Eyris and Wonderware are trademarks of Invensys plc, its subsidiaries and affiliates. All other brands may be trademarks of their respective owners.

All rights are strictly reserved. No part of this document may be reproduced, modified or transmitted in any form by any means, neither may it be stored in a retrieval system other than for the purpose to act as an aid in operating the equipment to which the document relates, without the prior written permission of Invensys Eurotherm Limited.

Invensys Eurotherm Limited pursues a policy of continuous development and product improvement. The specifications in this document may therefore be changed without notice. The information in this document is given in good faith, but is intended for guidance only. Invensys Eurotherm Limited will accept no responsibility for any losses arising from errors in this document.

Represented by:

HA027566/11 (CN29004)

i n v e n s y s
Eurotherm