



Kraus & Naimer

BLUE LINE switchgear

since 1907

Catalog 150 Switch and Optional Extras

02/2015

KG type up to 315 A
KH and KHR type up to 80 A



Kraus & Naimer

The development of the Blue Line rotary switch, contactor and motor starter product ranges is based on more than hundred years experience by Kraus & Naimer in the design and manufacture of electrical switchgear. Kraus & Naimer pioneered the introduction of the cam operated rotary switch and continues to be recognized as the world leader in that product field.

BLUE LINE

Blue Line products are protected by numerous patents throughout the industrial world. They are built to national and international standards and designed to withstand adverse temperatures and climates.

Blue Line products are accepted and universally recognized for their quality and workmanship. They are supported by a worldwide sales and service organization.

The Kraus & Naimer Registered Trademark



WORLDWIDE SYMBOL
FOR QUALITY SWITCHGEAR

Disconnectors and Main Switches acc. to IEC 60947-3 see Catalog 500

Contents	KG Switches	KH, KHR Switches
	Page	Page
Construction Data	4	25
Nominal Ratings	5	25
How to order	6, 7	6, 7
Types of Mounting and Enclosures	8-10	26, 27
Switch Function and Configuration	11-13	27
Escutcheon Plates	14	28
Handles	15	29
Optional Extras		
Shaft Extensions	18	31
Auxiliary Contacts	16	30, 31
Protective Covers	16	30
Ground and Neutral Terminals	17	31
Padlock Devices	20	34
Door Clutches	18, 19	32, 33
Additional Main Contacts	17	
Additional Module for Motor Control Center (MCC)	21	
Angular drive	21	
Technical Data	22, 23	36, 37
International Standards and Approvals	24	35
Dimensions		
Types of Mounting and Enclosures	38-42	48, 49, 51
Optional Extras	42-47	50-53
Blue Line Switchgear: Summary		54

Construction Data

Disconnectors and Main Switches according to IEC 60947-3 see Catalog 500

KG Switches

The KG10A through KG317 switch line offers excellent performance characteristics and exceed the requirements of IEC 60947-3 as well as the new VDE 0660 part 107. KG switches are principally used as motor and industrial panel disconnectors, double-throw transfer switches, safety switches, main disconnect switches and distribution system isolation switches. This durable switch line possesses high short-circuit withstand capabilities, with positive contact movement during making and breaking functions. KG switches exhibit excellent AC-3 and AC-23 making and breaking capabilities providing an additional safety advantage.

The safety level of the KG switch series in numerous areas surpasses those of many international standards organizations: Positive contact movement during making and breaking operations. Higher dimensioned air and creepage distances for 690 V or 1000 V. Dead front, finger-proof box terminals according to EN 50274, VDE 0660 part 514 and BGV A3. Switch types KG210, KG250 and KG315 require an option protective cover.

This advanced switch-generation affords significant advantages during mounting and wiring. For ease of installation, switch terminals are on the same plane as the power conductors. The KG10A through KG105C base mounted switches feature a two hole mounting as well as a "quick mount" designed for standard DIN rails according to EN 50022. KG125 through KG317 feature a four hole mounting.

The flexibility of the KG's modular system offers maximum versatility for the modifying of switches in the field. Modules can easily be added to switches which have already been installed in equipment often without having to remove existing wiring. This modular design also minimizes the need for high inventory levels. Other important accessories such as make before break auxiliary contacts, additional box and bolt terminals, shaft extensions, door clutches, terminal covers and padlock devices enhance the flexibility and versatility of this proven line of switches.

Modular System (KG20-KG317)

Max. 4 cam- or rack-operated auxiliary contacts (KG20-KG162),
KG210-KG317 max. 6
(KG125-KG162 6 pole max. 8)

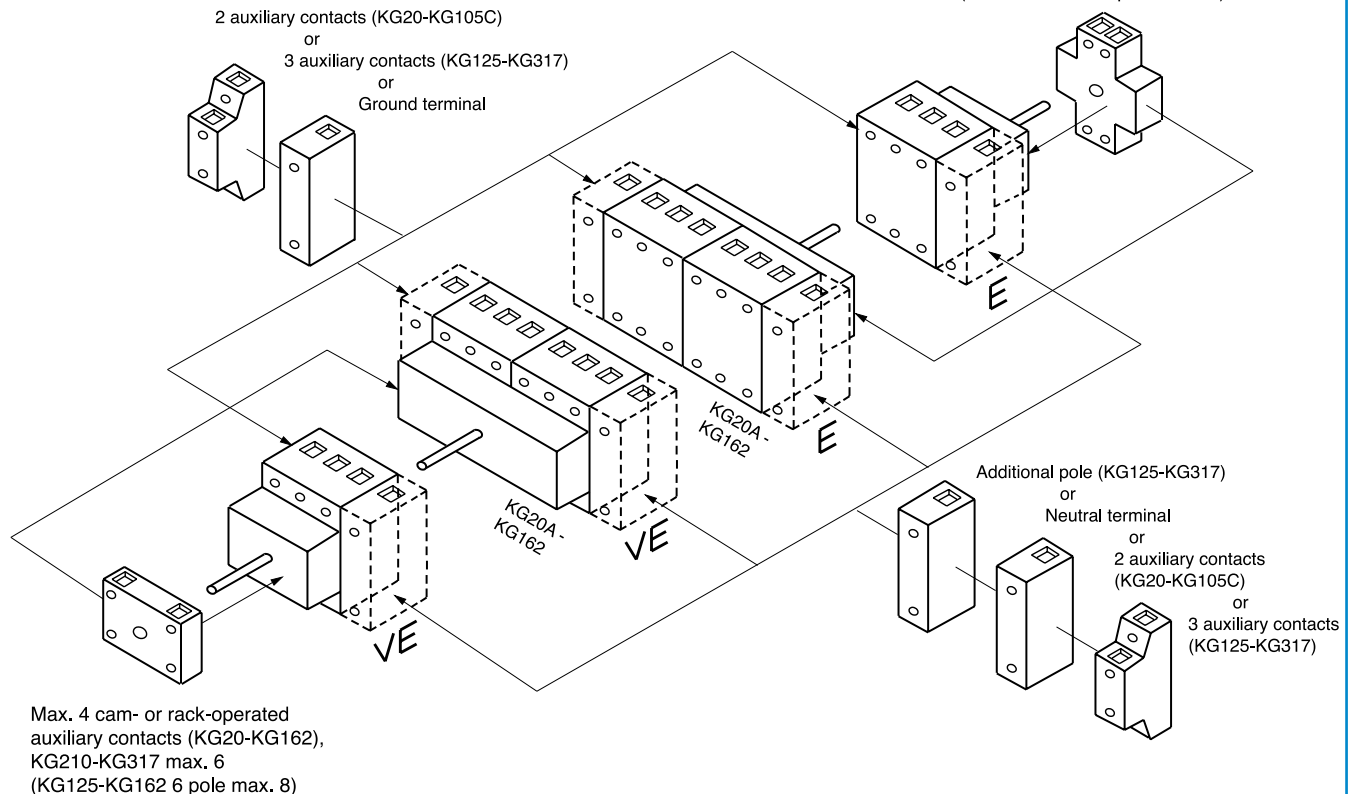

Nominal Ratings

Escutcheon Plate Frame mm			Typen	IEC 60947-3/VDE 0660 part 107			UL and Canada		
				Rated Values			Standard Motor Load		
			Thermal Current I_U/I_{th} A	Utilization Category AC-23A kW	AC-3 V-440 V kW	Ampere-Rating 3 x 600 V A	DOL-Rating 3 x 240 V HP	3 x 480 V HP	
48 x 48		64 x 64	KG10A	20	5,5	3,7	20	2	3
			KG10B	20	5,5	3,7	20	2	3
30 x 30	48 x 48	64 x 64	KG20	25	7,5	5,5	25	3	5
			KG20A	25	7,5	5,5	25	3	5
			KG20B	25	7,5	5,5	25	3	5
			KG32	32	11	7,5	30	5	10
			KG32A	32	11	7,5	30	5	10
			KG32B	32	11	7,5	30	5	10
48 x 48		64 x 64	KG41	40	15	11	40	7,5	15
			KG41B	40	15	11	40	7,5	15
			KG64	63	22	18,5	60	10	20
			KG64B	63	22	18,5	60	10	20
64 x 64		88 x 88	KG80	80	30	22	80 ¹	20	40
			KG80C	80	30	22	80 ¹	20	40
			KG100	100	37	30	100 ¹	25	50
			KG100C	100	37	30	100 ¹	25	50
			KG105	125	45	37	125	30	60
			KG105C	125	45	37	125	30	60
88 x 88		88 x 88	KG125	125	45	37	150 ¹	30	60
			KG126	125	45	37	150 ¹	30	60
			KG127	125	45	37	150 ¹	30	60
			KG160	160	55	45	200 ¹	40	60
			KG161	160	55	45	200 ¹	40	60
			KG162	160	55	45	200 ¹	40	60
KG125, KG160 KG210, KG250, KG315 (with box terminals)		KG126, KG161 KG211, KG251, KG316 (with bolt terminals)	KG210	200	75	55	200 ¹	50	75
			KG211	200	75	55	200 ¹	50	75
			KG212	200	75	55	200 ¹	50	75
88 x 88			KG250	250	90	55	250 ¹	60	75
			KG251	250	90	55	250 ¹	60	75
			KG252	250	90	55	250 ¹	60	75
			KG315	315	110	75	300 ¹	75	100
			KG316	315	110	75	300 ¹	75	100
			KG317	315	110	75	300 ¹	75	100

¹Valid when connected with wire rated for 75 °C.

How to order

Disconnectors and Main Switches according to IEC 60947-3 see Catalog 500

Three or four pieces of data (shown below) are required for ordering Blue Line Switch Disconnectors. Code numbers for ordering are shown in this catalog.

1. Type of Switch

The type of switch required may be easily selected by referring to the tables on pages 5 and 25 which show the thermal current and power rating of each switch. For further technical details, refer to pages 22/23 and 36/37.

2. Switch Function

The code numbers for the KG switches shown on pages 11-13 and on page 27 for the KH switches indicate the switch function, escutcheon plates and handles. Additional coding to modify the type and color of handle and escutcheon plate is explained below and on page 7.

3. Type of Mounting

Switch types and enclosures for the KG switches are shown on pages 8-10. The KH switches may be selected by referring to the table on page 26.

KG100

**K302-600
M004**

VE

4. Optional Extras

Pages 16-21 list optional extras and their coding for the KG switches. For the KH/KHR switches refer to pages 30-34. A table shows the different switch sizes in which the optional extra is available.

There are some optional extras which are available in a variety of programs. Additional ordering data may, therefore, be required.

< back to table of contents >

Modification of Switches

The part number or switch function and options may be modified in cases where items are required other than standard. The modification may involve the escutcheon plate inscription, color combination of escutcheon plate and handle, type of escutcheon plate and handle, or the optional extra.

Color combination of escutcheon plate and handle for KG and KH/KHR switches

Switch Type	Escutcheon Plate Frame	Handle	Escutcheon Plate Backing	Escutcheon Plate Lettering	Dash Number
KG, KH/KHR	black	black	brushed alu	black	-600
KG, KH/KHR	black	black	black	mat silver	-700

Other colour combinations available on request.

How to order

Modification of Switches

Color combinations of escutcheon plate and handle for KG and KH/KHR switches

The standard switch consists of a transparent escutcheon plate with brushed aluminum backing and black inscription. The escutcheon plate frame is black and it has a black handle. Pages 6, 14 and 28 show further combinations which are available. The subcoding shown on this page should be specified when color combinations are required.

Example: The complete coding for switch type KG100 with a 3 pole ON/OFF switch function, electro-gray handle and electro-gray escutcheon plate frame with brushed aluminum backing and black inscription which reads **0-1** is as follows: **KG100 K300-100 E**.

The following is a list of special programs for escutcheon plate and handle combinations. They may be obtained by specifying any one of the corresponding two digit dash-numbers as a part of the dash-number. It is necessary to prefix these two numbers with a digit number which represents the color combination required.

Special programs for plate and handle combinations for KG and KH/KHR switches

- **000** = without escutcheon plate, without handle
- **.01** = without escutcheon plate
- **.02** = without handle
- **.03** = with square escutcheon plate without lettering
- **.04** = with rectangular escutcheon plate without lettering
- **.05** = with square escutcheon plate without lettering and without handle
- **.06** = with rectangular escutcheon plate without lettering and without handle
- **.07** = standard escutcheon plate, without lettering on rectangular section
- **.08** = with F-handle
- **.09** = with P-handle
- **.10** = escutcheon plate frame and fixation ring only (if using switches with single hole mounting: - **.16**)
- **.11** = without escutcheon plate, but with handle bearing plate
- **.12** = with yellow escutcheon plate backing and red handle
- **.14** = with B-handle
- **.16** = escutcheon plate frame and fixation ring only if using switches with single hole mounting

Example: The complete coding for switch type KG100C with a 3 pole ON/OFF switch function with electro-gray escutcheon plate frame, square escutcheon plate without lettering, brushed aluminum plate backing and electro-gray handle reads as follows: **KG100C K300-103 VE**.

Handles, Escutcheon Plates and Optional Extras

Various standards for the KG switches are listed in the table on pages 8-10 and for the KH/KHR switches on page 26.

When a handle, escutcheon plate or optional extra is required but not covered by the dash-number, the code number for the selected component should be entered separately. A complete range of standard escutcheon plates are illustrated on pages 14/15 and 28/29. Non standard or special escutcheon plate engravings are available at extra cost.





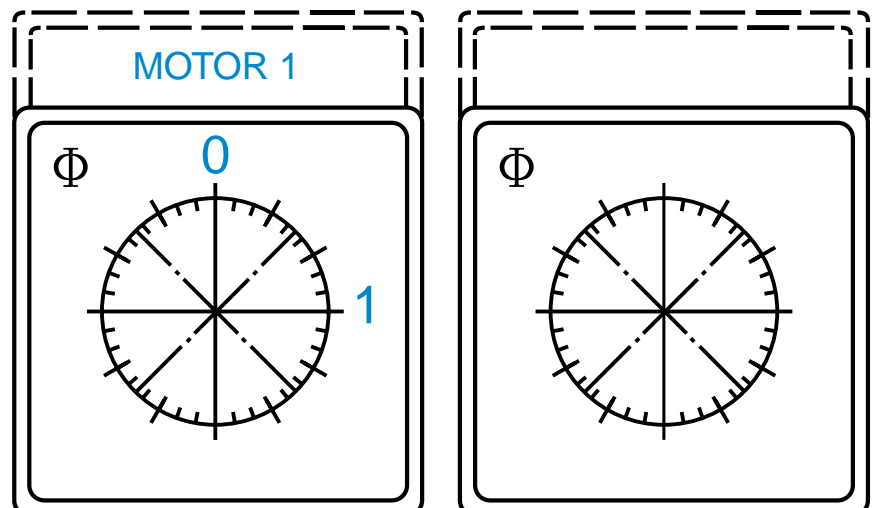

Ordering of Special Escutcheon Plates

When ordering special escutcheon plates it is advisable to use our order form, as illustrated.

Example: Customer's requirements are shown beside.



Order forms are available upon request.

Mounting	Type	Code
Front mounting		
	Two hole panel mounting, Protection IP 66/67	KG20 KG32
	Four hole panel mounting, Protection IP 66/67 Protection IP 66/67	KG10A KG41- KG100 KG160- KG315
Single hole mounting 22 mm		
	Without escutcheon plate, Protection IP 66/67/69k	KG10A KG20A KG32A
	With square escutcheon plate, Protection IP 66/67/69k	KG10A KG20A KG32A
		
Base mounting		
	Screw/Snap-on base mounting for track EN 50022, Protection IP 40	KG10A- KG317
	Snap-on base mounting for track EN 50022, Protection IP 40	KG125- KG162
	Screw base mounting (KG20A-KG162) and Snap-on base mounting (KG20A-KG105) for track EN 50022. Escutcheon plate for 45 mm knock-out. Protection IP 40	KG20A KG32A KG41- KG64B KG80- KG105 KG125- KG162
	Snap-on base mounting for track EN 50022. Both the escutcheon plate for 45 mm standard knock-out and the handle are adjustable in height. Protection IP 40	KG10A

Plastic Enclosure Protection IP 66	Type	Code
------------------------------------	------	------



The KL and CL enclosures are available in 3 sizes allowing for installation of 3, 4, 6 and 8 pole KG switches. The KL-series is made of strong durable plastic and offers high UV-resistance. All KL- and KS-enclosures are flame resistant in accordance with UL94V-0. The CL-series is especially designed for applications in an aggressive environment, such as oil, chemical substances and grease. Each enclosure has 2 knock-outs on top and bottom for metric thread according to EN 50262. Included in each enclosure is a ground and neutral terminal. One of these terminals must be eliminated if a 3 pole switch with lateral mounted auxiliary contacts or a 4 pole switch is installed. All enclosures can be supplied with a cover coupling for additional safety. Increased wiring space and mounting holes with slots are featured in this new line. These enclosures are also available for conduit entries for PG-thread. Protection IP 66

KG20
KG32
KG20B
KG32B
KG41
KG64
KG41B
KG64B
KG80
KG100
KG105

Without cover interlock, Protection IP 66

KL.0
CL.0

With cover interlock, Protection IP 66
(The enclosure can only be opened at 9 o'clock position)

KL.1
CL.1

With cover interlock, Protection IP 66
(The enclosure can only be opened at 12 o'clock position)

KL.2
CL.2



KS and CS enclosures have a compact size which allows for the installation of a 3, 4 or 6 pole KG10 ON/OFF switch or a 3 pole KG20 ON/OFF switch. The design, options and mounting are the same as those of the KL and CL enclosures. Protection IP 66

KG10
KG20

Without cover interlock, Protection IP 66

KS50
CS50

With cover interlock, Protection IP 66
(The enclosure can only be opened at 9 o'clock position)



KS51
CS51

With cover interlock, Protection IP 66
(The enclosure can only be opened at 12 o'clock position)

KS52
CS52

[< back to table of contents >](#)

Plastic Enclosure with Ground Terminal Protection IP 65 resp. IP 54	Threads	Type	Code
---	---------	------	------

 <p>KG20A, KG32A, KG41, KG64 3 and 4 pole (ON/OFF Switches) Protection IP 65</p>	<p>Conduit entries with NPT-thread, Protection 65</p>		<p>KG20A KG32A KG41 KG64</p>	<p>PFA4 PFA PFD4 PFD</p> <p>PFB4 PFB PFE4 PFE</p> <p>PFC4 PFC PFF4 PFF</p>
	Without cover coupling	1/2" 3/4"		
	And for switches with cam-operated auxiliary contacts	1/2" 3/4"		
	With cover coupling	1/2" 3/4"		
	And for switches with cam-operated auxiliary contacts	1/2" 3/4"		
	Without cover coupling, combined with padlock device V840A And for switches with cam-operated auxiliary contacts	1/2" 3/4" 1/2" 3/4"		
 <p>KG80, KG100 3 and 4 pole¹ (ON/OFF Switches) KG20B, KG32B, KG41B, KG64B 6 and 8 pole (ON/OFF Switches) 3 and 4 pole (Double-throw Switches) Protection IP 54 On top and at the bottom an additional conduit entry .63"</p>	<p>Conduit entries with NPT-thread, Protection 54</p>		<p>KG20B KG32B KG41B KG64B KG80 KG100</p>	<p>PFA5 PFA PFD5 PFD</p> <p>PFB5 PFB PFE5 PFE</p> <p>PFC5 PFC PFF5 PFF</p>
	Without cover coupling	3/4" 1"		
	And for switches with cam-operated auxiliary contacts	3/4" 1"		
	With cover coupling	3/4" 1"		
	And for switches with cam-operated auxiliary contacts	3/4" 1"		
	Without cover coupling, combined with padlock device V840A And for switches with cam-operated auxiliary contacts	3/4" 1" 3/4" 1"		
<p>These enclosures are also available with PG-, BSI- or metric ISO-thread on request.</p>				

[< back to table of contents >](#)

¹For switches with cam-operated auxiliary contacts only 3 pole.

Function	KG10A	KG10B	KG20 KG32	KG20A KG32A	KG20B KG32B	KG41 KG64	KG41B KG64B	KG80 KG100 KG105	KG80C KG100C KG105C	KG125- KG317	Escutch. Plate	Code
----------	-------	-------	--------------	----------------	----------------	--------------	----------------	------------------------	---------------------------	-----------------	-------------------	------

ON/OFF Switches 3 pole

Types of Mounting

Without auxiliary contacts	E	E	E	E	E	E	E	E	E	E		K300-600
	FT1 FT2 VE VE21 KS. ²	VE	VE	FT1 FT2 VE VE2 PF..	VE	VE VE2	VE VE2	VE VE2	VE	VE VE1 ³ VE2 ³		K300-620
With cam/rack-operated auxiliary contact 1 NO	E	E	E	E	E		E	E	E	E		K301-600
	FT1 FT2 VE VE21 KS. ²	VE	VE	FT1 FT2 VE VE2 PF..	VE	VE VE2	VE VE2	VE VE2	VE	VE VE1 ³		K301-620
With cam/rack-operated auxiliary contacts 1 NO and 1 NC	E	E	E	E	E		E	E	E	E		K302-600
	FT1 FT2 VE VE21 KS. ²	VE	VE	FT1 FT2 VE VE2 PF..	VE	VE VE2	VE VE2	VE VE2	VE	VE VE1 ³		K302-620
With cam/rack-operated auxiliary contacts 2 NO			E	E	E		E	E	E	E		K312-600
			VE KL.	FT1 FT2 VE VE2 PF..	VE	VE VE2 KL. PF..	VE VE2	VE VE2 KL. PF.. ⁴	VE	VE VE1 ³		K312-620
With lateral mounted auxiliary contacts 1 NO and 1 NC			E	E	E	E	E	E	E			K304-600
			VE KL.	FT1 FT2 VE VE2 PF..	VE	VE VE2 KL. PF..	VE VE2	VE VE2 KL. PF.. ⁴	VE			K304-620
With GRD-terminal			E	E	E	E	E	E	E	E		K305-600
			VE	FT1 FT2 VE VE2	VE	VE VE2	VE VE2	VE VE2	VE	VE VE1 ³ VE2 ³		K305-620
With GRD- and N-terminal			E	E	E	E	E	E	E	E		K307-600
			VE	FT1 FT2 VE VE2	VE	VE VE2	VE VE2	VE VE2	VE	VE VE1 ³ VE2 ³		K307-620









[< back to table of contents >](#)

¹Only for switch type KG20. ²When using KS. the switch type changes to KG10. ³Only for switch types KG125-KG162. ⁴Only for switch types KG80 and KG100.

Function	KG10A	KG10B	KG20 KG32	KG20A KG32A	KG20B KG32B	KG41 KG64	KG41B KG64B	KG80 KG100 KG105	KG80C KG100C KG105C	KG125- KG317	Escutch. Plate	Code
----------	-------	-------	--------------	----------------	----------------	--------------	----------------	------------------------	---------------------------	-----------------	-------------------	------







ON/OFF Switches 4 pole

Types of Mounting

Without auxiliary contacts	E	E	E	E	E	E	E	E	E	E		K400-600
	FT1 FT2 VE VE21 KS. ¹	VE	VE	FT1 FT2 VE VE2 PF..	VE	VE VE2	VE	VE VE2	VE	VE VE1 ² VE2 ²		K400-620
With cam-operated auxiliary contact 1 NO			E	E	E		E	E	E	E		K401-600
			VE KL.	FT1 FT2 VE VE2 PF..	VE	VE VE2 KL. PF..	VE	VE KL.	VE	VE VE1 ²		K401-620
With cam-operated auxiliary contacts 1 NO and 1 NC	E	E	E	E	E		E	E	E	E		K402-600
	FT1 FT2 VE VE21 KS. ¹	VE	VE	FT1 FT2 VE VE2 PF..	VE	VE VE2	VE	VE KL.	VE	VE VE1 ²		K402-620
With lateral mounted auxiliary contacts 1 NO and 1 NC			E	E	E	E	E	E	E			K404-600
			VE	FT1 FT2 VE VE2 PF..	VE	VE VE2	VE	VE VE2 PF. ³	VE			K404-620

[< back to table of contents >](#)

ON/OFF Switches 6 pole



Without auxiliary contacts	E	E		E	E		E	E	E	E ²		K600-600
	FT1 FT2 VE VE21 KS. ¹	VE		VE VE2	VE KL. PF..		VE VE2 KL. PF..	VE VE2	VE	VE ² VE1 ²		K600-620
With cam-operated auxiliary contact 1 NO				E	E		E	E	E	E ²		K601-600
				VE VE2	KL. PF..		VE VE2 KL. PF..	VE	VE	VE ² VE1 ²		K601-620
With cam-operated auxiliary contacts 1 NO and 1 NC	E	E		E	E		E	E	E	E ²		K602-600
	FT1 FT2 VE VE21 KS. ¹	VE		VE VE2	KL. PF..		VE VE2 KL. PF..	VE	VE	VE ² VE1 ²		K602-620

¹When using KS. the switch type changes to KG10. ²Only for switch types KG125-KG162. ³Only for switch types KG80 and KG100.



Function	KG10A	KG10B	KG20A KG32A	KG20B KG32B	KG41B KG64B	KG80 KG100 KG105	KG80C KG100C KG105C	KG125- KG162	Escutch. Plate	Code
----------	-------	-------	----------------	----------------	----------------	------------------------	---------------------------	-----------------	-------------------	------

ON/OFF Switches 8 pole



Types of Mounting

Without auxiliary contacts			E VE VE2	E VE KL. PF..	E VE VE2 KL. PF..	E VE VE2	E VE	E VE VE1	 	K800-600 K800-620
----------------------------	--	--	----------------	------------------------	-------------------------------	----------------	---------	----------------	--	--

Double-throw Switches 3 pole

Without auxiliary contacts			E VE VE2	E VE KL. PF..	E VE VE2 KL. PF..	E VE VE2	E VE	E VE VE1	 	K900-600 K900-620
----------------------------	--	--	----------------	------------------------	-------------------------------	----------------	---------	----------------	--	--

Double-throw Switches 4 pole

Without auxiliary contacts			E VE VE2	E VE KL. PF..	E VE VE2 KL. PF..	E VE VE2	E VE	E VE VE1	 	K950-600 K950-620
----------------------------	--	--	----------------	------------------------	-------------------------------	----------------	---------	----------------	---	--

[< back to table of contents >](#)

Connection Diagrams

ON/OFF Switches 3 pole (with cam-operated auxiliary contacts)

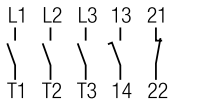

ON/OFF Switches 4 pole (with cam-operated auxiliary contacts)

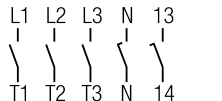

ON/OFF Switches 6 pole (with cam-operated auxiliary contacts)

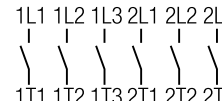

With lateral mounted auxiliary contacts

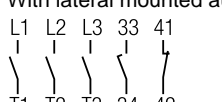

Mounting E, FT1, FT2

With lateral mounted auxiliary contacts

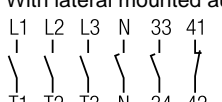

Mounting E, FT1, FT2

ON/OFF Switches 8 pole

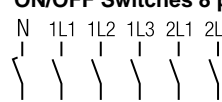

With GRD-terminal

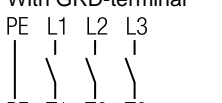

Double-throw Switches 3 pole

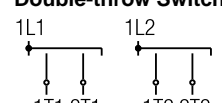

With GRD- and N-terminal

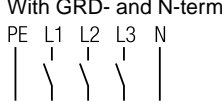

Double-throw Switches 4 pole

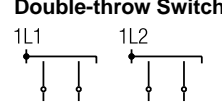

Square and rectangular escutcheon plates are available for each size of switch. The escutcheon plate consists of a frame and a faceplate having the switch position which is then embossed with hot-foil backing. The escutcheon plate frame is an essential part of the switch and serves as a bearing surface for the handle. If the switch is to be mounted without an escutcheon plate we would recommend the handle bearing plate T100-04, which is available for switch types KG10B, KG20B, KG32B, KG41B, KG80, KG100, KG105, KG80C, KG100C, KG105C and KG125-KG317. Escutcheon plates with special lettering are also available upon request.

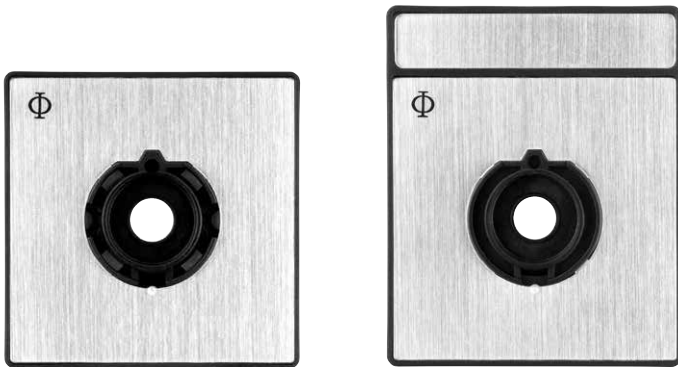

Escutcheon plate frame and faceplate can be obtained in different colors as listed below and defined in the first digit of the dash-number (1, 5, 6, 7):

Switch Type	Escutcheon Plate Frame	Handle	Escutcheon Plate Backing	Escutcheon Plate Lettering	Dash-number
KG10A ¹ -KG317	electro-gray	electro-gray	brushed alu	black	-100
KG10A ¹ -KG317	electro-gray	electro-gray	black	mat silver	-500
KG10A-KG317	black	black	brushed alu	black	-600
KG10A-KG317	black	black	black	mat silver	-700

Standard Escutcheon Plates

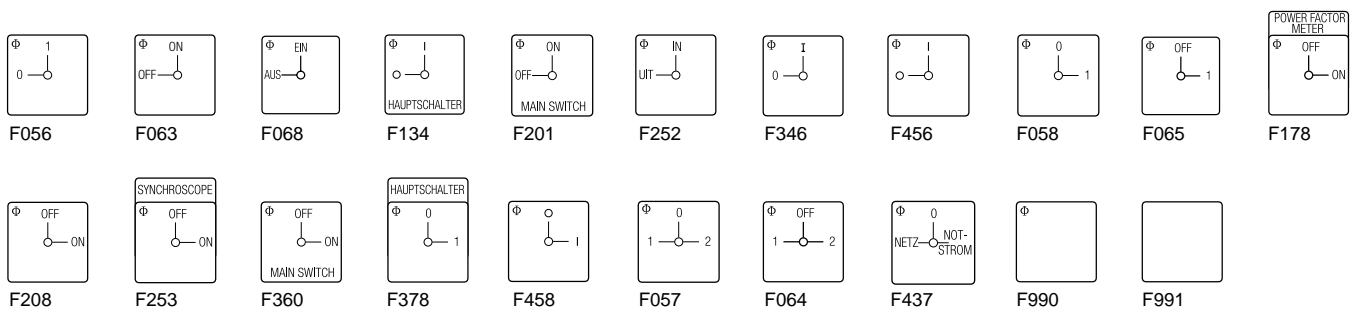

[< back to table of contents >](#)







¹Not available for switch types KG20 and KG32.

Handles

KG Switches

Type	Color	Code	KG20 KG32	KG10A- KG64	KG10B- KG105	KG80C- KG105C	KG125- KG162	KG210- KG317
------	-------	------	--------------	----------------	-----------------	------------------	-----------------	-----------------



Black and Red are standard colours. White and Electro-Grey available on request.

I-Handle 	black	G251	●	●	●	●	●	—
	red	G252	●	●	●	●	●	—
	white	G253	●	●	●	●	●	—
	electro gray	G257	●	●	●	●	●	—
B-Handle 	black	G521	—	●	●	—	—	—
	red	G522	—	●	●	—	—	—
	white	G523	—	●	●	—	—	—
	electro-gray	G527	—	●	●	—	—	—
R-Handle 	black	G001	—	●	●	●	●	—
	red	G002	—	●	●	●	●	—
	white	G003	—	●	●	●	●	—
	electro-gray	G007	—	●	●	●	●	—
F-Handle 	black	G221	●	●	●	●	●	—
	red	G222	●	●	●	●	●	—
	white	G223	—	●	●	●	●	—
	electro-gray	G227	—	●	●	●	●	—
L-Handle 	black	G501	—	—	●	—	—	—
	red	G502	—	—	●	—	—	—
	white	G503	—	—	●	—	—	—
	electro-gray	G507	—	—	●	—	—	—
P-Handle  KG10A-KG64 KG10B-KG317	black	G211	—	●	●	●	●	●
	red	G212	—	●	●	●	●	●
	white	G213	—	●	●	●	●	●
	electro-gray	G217	—	●	●	●	●	●
K-Handle 	black	G411	—	—	●	●	●	●
	red	G412	—	—	●	●	●	●
	white	G413	—	—	●	●	●	●
	electro-gray	G417	—	—	●	●	●	●



[< back to table of contents >](#)

Protective Covers, Auxiliary Contacts	Type	Code
--	------	------

Protective Covers



	For 3 resp. 4 main contacts	KG10A	M160/A12 K2
	For 3 main contacts with box terminal with bolt terminal	KG10B KG20- KG315 KG126 KG161 KG211 KG251 KG316	
	For 4 main contacts with box terminal with bolt terminal	KG20- KG315 KG126 KG161 KG211 KG251 KG316	M160/4. M160/43 M160/41







Cam- and rack-operated Auxiliary Contacts (mounting only at factory)

	Cam-operated auxiliary contacts Up to 4 cam-operated auxiliary contacts can be added to all switch configurations.	KG20- KG105C	M510A
	Select between a contact system with a rigid contact bridge for excellent AC-15 making and breaking capabilities or a H-bridge design with "cross-wire" contacts for low voltages and currents (mounting E from KG41 and mounting VE from KG80). The contact systems with gold contacts or gold-plated contacts allow for use in aggressive environments also. Special programs are also available upon request.		
	Rack-operated auxiliary contacts Switch types KG125-KG162 can be supplied with up to 4 auxiliary contacts, KG210-KG317 with up to 6 auxiliary contacts.	KG125- KG317	M510B
	Ordering data:	Quantity and operation of the auxiliary contacts and type of the contact system.	

[< back to table of contents >](#)

Lateral mounted Auxiliary Contacts

	Lateral mounted auxiliary contacts with 1 NO and 1 NC.	KG20- KG105C	H010/A11-E H010/A11-VE H010/B11-E H010/B11-VE														
	<p>Standard contacts (nonoverlapping)</p> <table border="0"> <tr> <td></td> <td colspan="2" style="text-align: center;">Terminal numbers Attachment</td> </tr> <tr> <td>For mounting E, FT1 and FT2</td> <td>left (33-34, 41-42)</td> <td>right (53-54, 61-62)</td> </tr> <tr> <td>For mounting VE, VE2, KL. and PF..</td> <td>(31-32, 43-44)</td> <td>(51-52, 63-64)</td> </tr> </table> <p>Overlapping contacts</p> <table border="0"> <tr> <td>For mounting E, FT1 and FT2</td> <td>(33-34, 41-42)</td> <td>(53-54, 61-62)</td> </tr> <tr> <td>For mounting VE, VE2, KL. and PF..</td> <td>(31-32, 43-44)</td> <td>(51-52, 63-64)</td> </tr> </table>			Terminal numbers Attachment		For mounting E, FT1 and FT2	left (33-34, 41-42)	right (53-54, 61-62)	For mounting VE, VE2, KL. and PF..	(31-32, 43-44)	(51-52, 63-64)	For mounting E, FT1 and FT2	(33-34, 41-42)	(53-54, 61-62)	For mounting VE, VE2, KL. and PF..	(31-32, 43-44)	(51-52, 63-64)
	Terminal numbers Attachment																
For mounting E, FT1 and FT2	left (33-34, 41-42)	right (53-54, 61-62)															
For mounting VE, VE2, KL. and PF..	(31-32, 43-44)	(51-52, 63-64)															
For mounting E, FT1 and FT2	(33-34, 41-42)	(53-54, 61-62)															
For mounting VE, VE2, KL. and PF..	(31-32, 43-44)	(51-52, 63-64)															
	Lateral mounted auxiliary contacts with 2 NO and 1 NC.	KG125- KG317	H010/A21-E H010/A21-VE H010/B21-E H010/B21-VE														
	<p>Standard contacts (nonoverlapping)</p> <table border="0"> <tr> <td></td> <td colspan="2" style="text-align: center;">Terminal numbers Attachment</td> </tr> <tr> <td>For mounting E</td> <td>left (013-014, 023-024, 031-032)</td> <td>right (043-044, 053-054, 061-062)</td> </tr> <tr> <td>For mounting VE</td> <td>(011-012, 023-024, 033-034)</td> <td>(041-042, 053-054, 063-064)</td> </tr> </table> <p>Overlapping of 1 NO and 1 NC</p> <table border="0"> <tr> <td>For mounting E</td> <td>(013-014, 023-024, 031-032)</td> <td>(043-044, 053-054, 061-062)</td> </tr> <tr> <td>For mounting VE</td> <td>(011-012, 023-024, 033-034)</td> <td>(041-042, 053-054, 063-064)</td> </tr> </table>			Terminal numbers Attachment		For mounting E	left (013-014, 023-024, 031-032)	right (043-044, 053-054, 061-062)	For mounting VE	(011-012, 023-024, 033-034)	(041-042, 053-054, 063-064)	For mounting E	(013-014, 023-024, 031-032)	(043-044, 053-054, 061-062)	For mounting VE	(011-012, 023-024, 033-034)	(041-042, 053-054, 063-064)
	Terminal numbers Attachment																
For mounting E	left (013-014, 023-024, 031-032)	right (043-044, 053-054, 061-062)															
For mounting VE	(011-012, 023-024, 033-034)	(041-042, 053-054, 063-064)															
For mounting E	(013-014, 023-024, 031-032)	(043-044, 053-054, 061-062)															
For mounting VE	(011-012, 023-024, 033-034)	(041-042, 053-054, 063-064)															

Ground and Neutral Terminals	Type	Code	Additional Main Contacts	Type	Code																																						
<p>Ground terminal</p>  	KG20- KG32B	K0 H052/A	 <p>Terminals for Control Circuit</p>  <p>Max. Permissible Wire Gage Single-core or Flexible wire stranded wire</p> <table border="1"> <tr> <td>2,5 mm² AWG12</td> <td>2,5 mm² AWG14</td> <td rowspan="2">KG41- KG64B</td> <td rowspan="2">K1B D220 KS</td> </tr> <tr> <td>2,5 mm² AWG12</td> <td>2,5 mm² AWG14</td> </tr> <tr> <td>4 mm² AWG10</td> <td>4 mm² AWG12</td> <td>KG80- KG105C</td> <td>K2B D520 KSA</td> </tr> <tr> <td>4 mm² AWG10</td> <td>4 mm² AWG12</td> <td>KG125- KG162</td> <td>K3A D720 KS</td> </tr> <tr> <td colspan="2"></td> <td>KG210- KG317</td> <td>K3B D520 KS</td> </tr> <tr> <td colspan="2"></td> <td>KG126 KG161</td> <td rowspan="3">K3A D720 09</td> </tr> <tr> <td colspan="2"></td> <td>KG127 KG162</td> </tr> <tr> <td colspan="2"></td> <td>KG210 KG250 KG315</td> </tr> <tr> <td colspan="2"></td> <td>KG211 KG251</td> <td rowspan="3">K3B D520 09</td> </tr> <tr> <td colspan="2"></td> <td>KG212 KG252</td> </tr> <tr> <td colspan="2"></td> <td>KG316 KG317</td> </tr> </table>	2,5 mm ² AWG12	2,5 mm ² AWG14	KG41- KG64B	K1B D220 KS	2,5 mm ² AWG12	2,5 mm ² AWG14	4 mm ² AWG10	4 mm ² AWG12	KG80- KG105C	K2B D520 KSA	4 mm ² AWG10	4 mm ² AWG12	KG125- KG162	K3A D720 KS			KG210- KG317	K3B D520 KS			KG126 KG161	K3A D720 09			KG127 KG162			KG210 KG250 KG315			KG211 KG251	K3B D520 09			KG212 KG252			KG316 KG317	<p>KG125 KG126 KG127</p> <p>KG160 KG161 KG162</p> <p>KG210 KG250 KG211 KG251 KG212 KG252</p> <p>KG315 KG316 KG317</p>	<p>K3 H050/P¹ K3 H050/Q¹ K3 H050/R¹</p> <p>K3 H050/S¹ K3 H050/T¹ K3 H050/U¹</p> <p>K3 H050/G¹ K3 H050/H¹ K3 H050/J¹</p> <p>K3 H050/K¹ K3 H050/L¹ K3 H050/M¹</p>
	2,5 mm ² AWG12	2,5 mm ² AWG14		KG41- KG64B	K1B D220 KS																																						
	2,5 mm ² AWG12	2,5 mm ² AWG14																																									
	4 mm ² AWG10	4 mm ² AWG12		KG80- KG105C	K2B D520 KSA																																						
	4 mm ² AWG10	4 mm ² AWG12		KG125- KG162	K3A D720 KS																																						
				KG210- KG317	K3B D520 KS																																						
				KG126 KG161	K3A D720 09																																						
				KG127 KG162																																							
				KG210 KG250 KG315																																							
				KG211 KG251	K3B D520 09																																						
				KG212 KG252																																							
				KG316 KG317																																							
	<p>Neutral terminal</p>  	KG20- KG32B		K0 H053/A	<p>Ordering data:</p> <p>Switch mounting.</p>																																						
		KG41- KG64B		K1 H053/B																																							
KG80- KG100C		K2 H053/C																																									
KG125 KG160		K3 H053/H¹																																									
KG126 KG161		K3 H053/J¹																																									
KG127 KG162		K3 H053/K¹																																									
KG210 KG250 KG315		K3 H053/D¹																																									
KG211 KG251		K3 H053/E¹																																									
KG212 KG252		K3 H053/F¹																																									
KG316 KG317		K3 H053/L¹ K3 H053/M¹																																									
		Wiring Aid																																									
																																											
		KG126 KG127 KG161 KG162																																									
		KG211 KG212 KG251 KG252 KG316 KG317																																									

[< back to table of contents >](#)

¹Mounting only at factory.

Shaft Extensions, Simplified Door Clutch	Type	Code
--	------	------

Shaft Extensions

	<p>With asymmetric profile Shaft length not adjustable</p>	<p>KG10B KG20B, KG32B KG41B-KG105C</p>	<p>L100</p>
	<p>Shaft with adjustable length with set screw with shear ring</p>	<p>KG10A KG20A, KG32A KG41-KG317</p>	<p>M004D M004</p>
	<p>With square profile Shaft length not adjustable</p>	<p>KG10B KG20B, KG32B KG41B-KG105C</p>	<p>L100A</p>
	<p>Shaft with adjustable length with set screw with clamping bushing</p>	<p>KG41B-KG317 KG125-KG317</p>	<p>M004E M004A</p>
<p>Ordering data:</p>	<p>Free shaft length or dimension from mounting surface to cover.</p>		







Simplified Door Clutch

	<p>The simplified door clutches are utilized primarily when the switch is mounted to the bottom of the enclosure and the handle and escutcheon plate are mounted on the cover.</p>		
	<p>With shaft extension Front protection IP 40 Front protection IP 65</p>	<p>KG10A KG20A, KG32A KG41B-KG105</p>	<p>M290/A3 M290/A3.EF¹</p>
	<p>With profile extension parts Front protection IP 65</p>	<p>KG41B-KG105</p>	<p>M290/A1.EF</p>
	<p>With padlock device, single hole mounting 22 mm, protection IP 66. An additional aluminum shaft extension is required.</p>		
	<p>Loc bar is accessible from 3 o'clock which achieve a compact design.</p>	<p>KG10B KG20B, KG32B KG41B-KG105, KG125-KG317²</p>	<p>V840E</p>
	<p>The cover disc is available in black, yellow and electro-gray. The handle may be supplied in black, red and electro-gray.</p>	<p>KG10B KG20B, KG32B KG41B-KG105</p>	<p>V840G V840F</p>
	<p>Operation of the locking bar from the front. Available in black, red and electro-gray.</p>	<p>KG10A KG20A, KG32A KG41, KG64 KG10B KG20B, KG32B KG41B-KG105</p>	<p>V845</p>
<p>Centering device for simplified door clutches with single hole mounting and shaft extension Misalignment between the shaft and mounting are compen- sated in all 4 directions.</p>	<p>KG10B KG20B, KG32B KG41B-KG105</p>	<p>M600</p>	
<p>Ordering data:</p>	<p>Free shaft length or dimension from face of the switch to the cover and color selection.</p>		

¹Available for switch types KG10A, KG20A and KG32A. ²Only for ON/OFF switches 3 and 4 pole.

Door Clutches	Type	Code
	<p>The M280 door clutch has an adjustable shaft and can be supplied with an interlock device.</p> <p>With protected profile shaft fixation with set screw Front protection IP 40 Front protection IP 66/67 shaft fixation with shear ring Front protection IP 40 Front protection IP 66/67</p> <p>Without protected profile Front protection IP 40 Front protection IP 65</p> <p>Handle lockable with padlocks Protection IP 66 The escutcheon plate is available in black, yellow and alu. The handle may be supplied in black and red.</p> <p>The M700 is a padlock door clutch and a mechanical interlocking safety device. Using the device the electrical panel may be opened only when the switch is in the OFF position and no padlock is fitted. Note: Only in the ON position can knowledgeable personnel using a simple tool to defeat the interlock. The M700's flexibility allows for successful installation with as much as + or - 5 mm of misalignment between the shaft and door.</p> <p>Standard handle and standard escutcheon plate Protection IP 66 The M700's flexibility allows for successful installation with as much as + or - 5 mm of misalignment between the shaft and door.</p> <p>Unlock insert for the M700 to open the door in ON-position. (After the locking has been made inactive, it is necessary to take effective precautions against an opening of the door by unauthorized persons.)</p> <p>The M800 door clutch utilizes a simple and robust design and features a compact size. It has an interlock in the ON-position while a padlock can be fitted in the OFF-position. The door clutch may be opened only if the switch is in the OFF-position. In special cases, however, authorized people have a requirement to open the door, even if the switch is in the ON-position. Further characteristics are the single hole mounting with IP 66/67 protection degree, as well as the Accepted Misalignment up to ± 3 mm horizontally and ± 5 mm vertically. Maximum 3 padlocks with a minimum shackle diameter from 5 up to 8 mm are possible.</p>	<p>KG10A KG20A KG32A KG41B KG64B KG80 KG100 KG105 KG125- KG317</p> <p>M280E M280E/.EF</p> <p>M280D M280D/.EF</p> <p>KG41 KG64</p> <p>M280B/. M280B/.EF</p> <p>M700/.</p> <p>KG10B KG20B KG32B KG41B KG64B KG80 KG100 KG105 KG125- KG317</p> <p>M701</p> <p>S1D M700 29</p> <p>M810/. M800/.</p>
<p>Ordering data:</p>	<p>Dimension from face of the switch to the cover or dimension from mounting surface to cover, the interlock program and the color selection.</p>	

[< back to table of contents >](#)

Padlock Devices	Type	Code
 <p>The padlock device is an integral part of the switch.</p> <p>For 2 padlocks Operation of the locking bar from the bottom. Available in black, red and electro-gray.</p>	<p>KG10A KG20A, KG32A KG10B KG20B, KG32B KG41-KG105</p>	<p>V840A</p>
 <p>For 4 padlocks Operation of the locking bar from the front. Available in black, red and electro-gray.</p>	<p>KG10A KG20A, KG32A KG41, KG64 KG10B KG20B, KG32B KG41B, KG64B KG80-KG105 KG80C-KG105C KG125-KG317</p>	<p>V845</p>
 <p>For mounting VE2 Operation of the locking bar from the front.</p>	<p>KG10A KG20A, KG32A KG41, KG64 KG80-KG105</p>	<p>V840B</p>
 <p>For distribution box with 70 mm depth.</p>	<p>KG20A, KG32A KG41, KG64</p>	<p>V840H/..E</p>
 <p>Padlock device with integrated F- or B-handle. The cover disc is available in black, yellow and electro-gray. The handle may be supplied in black, red and electro-gray.</p>		
 <p>For 2 padlocks with F-handle</p>	<p>KG10A KG20A, KG32A KG41, KG64</p>	<p>V840D</p>
<p>For 3 padlocks with F-handle</p>	<p>KG80C-KG105C KG125-KG162</p>	
<p>For 3 padlocks with F-handle with B-handle</p>	<p>KG10B KG20B, KG32B KG41B, KG64B KG80-KG105</p>	<p>V840G V840G/B</p>
<p>For 4 padlocks with F-handle with B-handle</p>		<p>V840F/F V840F/B</p>
 <p>Padlock device for switches with base mounting for locking when control cabinet is opened.</p> <p>Padlock devices with simplified door clutch and single hole mounting see page 18.</p>	<p>KG20B, KG32B KG41B, KG64B KG80-KG105 KG125-KG317</p>	<p>V840VE</p>
<p>Ordering data:</p>	<p>For V840 and V845 color selection required.</p>	

[< back to table of contents >](#)

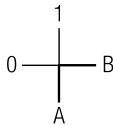
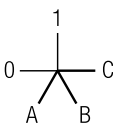
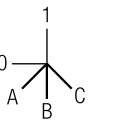
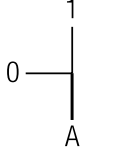
Additional Module for Motor Control Center (MCC), Angular drive	Type	Code
 <p>This additional module is for use in Motor Control Center (MCC). It allows for testing and unlocking, with up to 3 additional positions. The module is used in connection with the padlock device V840F and cam-operated auxiliary contacts. Interlock has to be assembled by the customer.</p> <p>ON-position: All circuits on, module interlocked, i. e. cannot be withdrawn.</p> <p>OFF-position: All circuits off, module interlocked, padlocks can be applied.</p> <p>Test position: Main incoming off, control circuits on, module interlocked.</p> <p>Isolated position: All circuits off, module can be withdrawn.</p> <p>Removed position: All circuits off, module can be removed.</p> <p>With 2 additional positions A = Test position B = Removed position</p> <p>With 3 additional positions A = Test position B = Isolated position C = Removed position</p> <p>With 3 additional positions A = Test position B = Isolated position C = Removed position</p> <p>With 1 additional position A = Removed position</p>    	<p>KG20B KG32B KG41B KG64B</p> <p>KG20B KG32B KG41B KG64B</p> <p>KG20B KG32B KG41B KG64B</p> <p>KG20B KG32B KG41B KG64B</p>	<p>V500/1</p> <p>V500/2</p> <p>V500/3</p> <p>V500/4</p>

[< back to table of contents >](#)

Angular drive

	<p>KG125- KG317¹</p>	<p>M330</p>
---	--	--------------------

¹Only for ON/OFF switches 3 and 4 pole.

Selection Data	KG10	KG20	KG32	KG41	KG64	KG80	KG100	KG105	KG125	KG160	KG210	KG250	KG315
	KG10A	KG20A	KG32A	KG41B	KG64B	KG80C	KG100C	KG105C	KG126	KG161	KG211	KG251	KG316
	KG10B	KG20B	KG32B						KG127	KG162	KG212	KG252	KG317

Rated Insulation Voltage U_i IEC/VDE ¹ UL/Canada CEE/NEMKO	V	690	690	690	690	690	690	690	690	1000 ²	1000 ²	1000 ²	1000 ²	1000 ²			
	V	300	600	600	600	600	600	600	600	600	600	600	600	600			
	V	400	500	500	500	500	500	500	-	-	-	-	-	-			
Rated Impulse Withstand Voltage U_{imp} ¹	kV	4	6	6	6	6	6	6	6	8	8	8	8	8			
Rated Thermal Current IEC/VDE $I_{u, open} = I_{th}$ $I_{the, enclosed}$ UL/Canada ON/OFF function UL/Canada Double-throw function	A	20	25	32	40	63	80	100	125	125	160	200	250	315			
	A	20	25	32	40	63	80	100	125	125	160	200	250	315			
	A	20	25	30	40	60	80 ³	100 ³	125	150 ³	200 ³	200 ³	250 ³	300 ³			
	A	20	25	30	40	60	80 ³	100 ³	115	125 ³	160 ³	-	-	-			
Rated Operational Current I_e AC-21A Switching of resistive loads, including moderate overloads	IEC/VDE	A	20	25	32	40	63	80	100	125	125	160	200	250	315		
	AC-22A Switching of combined resistive or low inductive loads, including moderate overloads	IEC/VDE	220 V-500 V 660 V-690 V	A	20 16	20 20	32 32	40 40	63 55	80 65	100 85	125 90	125 100	160 100	200 125	250 140	
Ampere-Rating ON/OFF function Double-throw function Resistive or low inductive loads	UL/Canada ⁴ 600 V	A	20 ⁷	25	30	40	60	80 ³	100 ³	125	150 ³	200 ³	200 ³	250 ³	300 ³		
	UL/Canada ⁴ 600 V	A	20 ⁷	25	30	40	60	80 ³	100 ³	115	125 ³	160 ³	-	-	-		
Rated Utilization Category AC-3 Direct-on-line starting	IEC/VDE	3 phase	220 V-240 V	kW	2,2	4	5,5	7,5	11	15	18,5	22	22	30	37	37	45
		3 pole	380 V-440 V	kW	3,7	5,5	7,5	11	18,5	22	30	37	37	45	55	55	75
			500 V	kW	3,7	5,5	7,5	15	22	30	37	45	45	55	75	75	90
			690 V	kW	3,7	5,5	7,5	11	15	18,5	22	22	30	37	40	40	45
AC-23A Frequent switching of motors or other high inductive loads	3 phase	220 V-240 V	kW	3	5,5	5,5	7,5	11	18,5	22	25	30	30	37	37	55	
	3 pole	380 V-440 V	kW	5,5	7,5	11	15	22	30	37	45	45	55	75	90	110	
		500 V	kW	5,5	7,5	11	18,5	30	37	45	55	55	75	90	110	132	
		690 V	kW	5,5	7,5	11	15	18,5	22	30	30	37	37	45	45	45	
DOL-Rating Standard motor load (similar AC-3)	UL/Canada ⁴ 120 V	HP	1	1,5	2	3	5	7,5	10	15	15	20	25	30	40		
	3 phase 240 V	HP	2	3	5	7,5	10	20	25	30	30	40	50	60	75		
	480 V	HP	-	5	10	15	20	40	50	60	60	60	75	75	100		
	3 pole 600 V	HP	-	5	10	15	20	50	50	50	60	60	75	75	100		
Power loss per contact at I_u Resistance to vibration ⁵ Resistance to shock ⁵	W	0,9	0,7	1,1	1	2,2	1,7	2,4	3,8	3,1	5	5	8	12,7			
	C	A	A	A	A	A	A	A	A	C	C	C	C	C			
	C	B	B	B	B	B	B	B	B	C	C	C	C	C			
Short Circuit Protection Max. fuse size (gL-characteristic) Rated short-time withstand current (1 s-current)	A	20	35	35	50	63	80	100	125	125	160	200	250	315			
	A	130	350	430	500	580	1600	1850	2000	2500	3000	4000	4600	5800			
Max. Permissible Wire Gage - Use copper wire only For box terminal Single-core or stranded wire	mm ²	2,5	6	6	16	16	50	50	50	95	95	185	185	185			
	AWG	12	10	10	6	6	1/0	1/0	1/0	3/0	3/0	-	-	-			
	MCM	-	-	-	-	-	-	-	-	-	-	350	350	350			
Flexible wire sleeving in accordance with DIN 46228	mm ²	2,5	4	4	10	10	35	35	35	70	70	120	120	120			
Flexible wire without sleeve	mm ²	2,5	4	4	10	10	35	35	35	70	70	150	150	150			
	AWG	12	10	10	6	6	2	2	2	2/0	2/0	-	-	-			
	MCM	-	-	-	-	-	-	-	-	-	-	300	300	300			
Cable lug or track must accept connection screw Max. width Max. width with protective cover	mm	-	-	-	-	-	-	-	-	M10 x 20	M10 x 20	M12 x 20	M12 x 20	M12 x 20			
	mm	-	-	-	-	-	-	-	-	20	20	25	25	25			
	mm	-	-	-	-	-	-	-	-	25	25	34	34	34			
	mm	-	-	-	-	-	-	-	-	25	25	34	34	34			
Min. Ambient Temperature Max. Ambient Temperature ⁶	open at 100 % I_u/I_{th} enclosed at 100 % I_{the}	-5 °C 50 °C during 24 hours with peaks up to 55 °C 35 °C during 24 hours with peaks up to 40 °C															

[< back to table of contents >](#)

¹Valid for lines with common neutral termination, overvoltage category III, pollution degree 3. Values for other supply systems on request. ²Suitable for no load switching applications (AC-20A) above 690 V. ³Valid when connected with wire rated for 75 °C. ⁴International Standards and Approvals, refer to page 24. ⁵A: min. 4 g, 2-100 Hz, 1,6 mm. B: min. 6 g, 6 ms. C: on request. ⁶Storage temperature: -40 °C to 85 °C (in case of temperature below -5 °C no shock load permissible). ⁷Max. 277 V.















Selection Data	KG10	KG20	Auxiliary contacts for:			
	KG10A KG10B	KG20B- KG32B	KG41- KG105C	KG125- KG162	KG210- KG317	

Rated Insulation Voltage U_i			IEC/VDE UL/Canada	V V	690 300	500 600	690 600	690 600	690 600
Rated Thermal Current I_U/I_{th}			IEC/VDE/BS UL/Canada	A A	10 20	- 10	16 10	16 10	16 10
Rated Operational Current I_e									
AC-21A	Switching of resistive loads, including moderate overloads	IEC/VDE		A	20	10	16	16	16
AC-15	Switching of control devices, contactors, valves etc.	110 V-240 V 380 V-440 V 500 V		A	6	2,5	6	6	6
				A	4	1,5	3	3	3
				A	-	1	1,5	1,5	1,5
Pilot Duty	Heavy	UL/Canada			A300	A600	A600	A600	A600
Ampere-Rating Resistive or low inductive loads			UL/Canada	A	20 ¹	10	10	10	10
Short Circuit Protection									
	Max. fuse size	(gL-characteristic)		A	20	10	16	16	16
Max. Permissible Wire Gage - Use copper wire only									
	Single-core or stranded wire		mm ²		2,5	1,5	2,5	2,5	2,5
			AWG		12	14	12	12	12
	Flexible wire sleeving in accordance with DIN 46228		mm ²		2,5	1,5	2,5	2,5	2,5
			AWG		12	16	14	14	14

[< back to table of contents >](#)

¹Max. 277 V.

Country	Authority	Mark or Standard	KG10	KG20	KG32	KG41	KG64	KG80	KG100	KG105	KG125	KG160	KG210	KG250	KG315
			KG10A	KG20A	KG32A	KG41B	KG64B	KG80C	KG100C	KG105C	KG126	KG161	KG211	KG251	KG316
			KG10B	KG20B	KG32B						KG127	KG162	KG212	KG252	KG317

USA	Underwriters Laboratories	 ¹ or 	●	●	●	●	●	●	●	●	●	●	●	●	●
Canada	Canadian Standards Association	 ² or  ^{5 c}	●	●	●	●	●	●	●	●	●	●	●	●	●
Switzerland	Schweizerischer Elektrotechnischer Verein		+	+	+	+	+	+	+	+	+	+	+	+	+
Danmark	Danmarks Elektriske Materielkontrol		+	+	+	+	+	+	+	+	+	+	+	+	+
Norway	Norges Elektriske Materielkontrol		+	+	+	+	+	+	+	+	+	+	+	+	+
Sweden	Svenska Elektriska Materielkontrollanstalten		+	+	+	+	+	+	+	+	+	+	+	+	+
Finland	Sähkötar-kastuskeskus		+	+	+	+	+	+	+	+	+	+	+	+	+
Austria	Österreichischer Verband für Elektrotechnik		+	+	+	+	+	+	+	+	+	+	+	+	+
Federal Republic of Germany	Verband Deutscher Elektrotechniker	VDE 0660 ³ VDE 0113 ³	+	+	+	+	+	+	+	+	+	+	+	+	+
Great Britain	British Standards Institution	BS EN 60947 ³	+	+	+	+	+	+	+	+	+	+	+	+	+
International Electrical Commission (IEC) Recommendation		IEC 60204-1 ⁴ IEC 60947-3 ⁴	+	+	+	+	+	+	+	+	+	+	+	+	+
China	China Quality Certification Centre	 GB14048.3	●	●	●	●	●	●	●	●	●	●	●	●	●
Russia Belarus Kazakhstan	Eurasian Conformity		●	●	●	●	●	●	●	●	●	●	●	●	●
Russian Federation	Russian Maritime Register of Shipping		●	●	●	●	●	●	●	●	●	●	●	●	●
Germanischer Lloyd			+	+	+	+	+	+	+	+	+	+	+	+	+
Lloyds Register EMEA			+	●	●	●	●	+	+	+	+	+	+	+	+

● Switch approved + Switch conforms to requirements

¹Devices provided with terminals suitable to connect unprepared wires are approved under the "Listing Program" (File No. E35541, Guide No. NLRV). Devices with bolt terminals are approved under the "Recognized Component Program" (File No. E35541, Guide No. NLRV2).

²Approved by use of "UL Certification Services for Canada" (File No. E35541, Guide No. NLRV7 or NLRV8 respectively).

³Industrial switchgear is not required to bear a symbol but must conform to requirements. By referring to the specific specification on the product the manufacturer implies that these requirements have been met.

⁴IEC does not operate an approval program.

⁵File No. 13002, Class No. 3211-05 resp. 4652-04.

KG switches are approved by UL and CSA as „disconnect switches for use in motor circuits“. Switches using ring type terminations (KG127, KG162, KG212, KG252, KG317) it is necessary to make connections to separate terminals.

[< back to table of contents >](#)

The switches described in this catalog exceed the requirements of IEC 60947-3 and VDE 0660 part 107 and meet the standard on main switches and maintenance switches.

The new series offers a 4 pole switch body and symmetrically placed contacts. The adjustable length through shaft offers increased stability and permits interlocking devices to be added at the end of the switch. While reduced forces of the latching mechanism allows for easier operation.

The safety level of the KH- and KHR-series in numerous areas surpasses those of many international standard organizations: Positive contact movement during making and breaking operations. Higher air and creepage distances as well as for 800 V or 1000 V and finger-proof terminals according to EN 50274, VDE 0660 part 514 and BGV A3 (protection IP 20 up to KHR40). Excellent AC-3 and AC-23A making and breaking capabilities providing an

additional safety advantage. For connecting with ring type terminals the KHR-series were designed. The terminal screw is held in place by a clamp allowing the ring type wire lug to be easily inserted in the terminal and tightened.

The KH- and KHR-series affords significant advantages during mounting and wiring. For ease of installation, switch terminations are on the same plane as the power conductors. Captive plus-minus screws and integrated screwdriver guides reduce wiring time. All base mounted switches feature a two hole mounting as well as "quick mount" designed for standard DIN rails according to EN 50022.

A large range of optional extras such as lateral mounted auxiliary contacts, ground terminals, auxiliary contacts (installed only at factory) also with contact systems for special programs, door clutches, shaft extensions and padlock devices enhance the flexibility of this proven line.

KH-series











KHR-series



[< back to table of contents >](#)

Nominal Ratings

Escutcheon Plate Frame mm	Type	IEC 60947-3/VDE 0660 part 107		UL and Canada			
		Rated Values	Utilization Category	Ampere- Rating	Standard Motor Load DOL-Rating		
		Thermal Current I_U/I_{th}	AC-23A 3 x 380 V-440 V	AC-3 3 x 600 V	A	3 x 240 V	3 x 480 V
		A	kW		A	HP	HP
48 x 48 	KH16	16	7,5	5,5	16	2	5
	KH20	20	10	6,5	20	2	5
	KH25	25	12	7,5	25	3	7,5
	KHR16	16	7,5	5,5	16	2	5
	KHR20	20	10	6,5	20	2	5
	KHR25	20	10	7,5	20	3	7,5
64 x 64 	KH16B	16	7,5	5,5	16	2	5
	KH20B	20	10	6,5	20	2	5
	KH25B	25	12	7,5	25	3	7,5
	KHR16B	16	7,5	5,5	16	2	5
	KHR20B	20	10	6,5	20	2	5
	KHR25B	20	10	7,5	20	3	7,5
64 x 64 	KH32	32	16	11	30	5	10
	KH40	40	20	15	40	7,5	15
	KHR32	32	16	11	30	5	10
	KHR40	32	16	15	30	7,5	15
	KH63	63	30	22	60	20	40
	KH80	80	40	30	80	25	50
	KHR63	63	30	22	60	20	40
	KHR80	80	40	30	80	25	50

Mounting	Type	Code
 <p>Panel mounting</p> <p>Four hole panel mounting, Protection IP 66/67</p>	KH16-KHR80	E
 <p>Single hole mounting 22 mm</p> <p>With square escutcheon plate 48 x 48 mm, Protection IP 66/67/69k</p>	KH16-KHR25	FT2
 <p>With square escutcheon plate 64 x 64 mm, Protection IP 66/67/69k</p>	KH16-KHR80	FH3¹
 <p>Base mounting</p> <p>Screw/Snap-on base mounting for track EN 50022, Protection IP 40</p>	KH16-KHR80	VE
 <p>Screw/Snap-on base mounting for track EN 50022. Escutcheon plate for 45 mm knock-out, Protection IP 40</p>	KH16-KHR80	VE2

[< back to table of contents >](#)

¹For KH63-KHR80 use flexible wire only in order to avoid excessive pressure on single hole mounting.

Plastic Enclosure Protection IP 66/67	Type	Code
---------------------------------------	------	------







	<p>The KL and CL enclosures are available in 3 sizes allowing for installation of 3, 4 and 6 pole KG switches. The KL-series is made of strong durable plastic and offers high UV-resistance. All KL- and KS-enclosures are flame resistant in accordance with UL94V-0. The CL-series is especially designed for applications in an aggressive environment, such as oil, chemical substances and grease. Each enclosure has 2 knock-outs on top and bottom for metric thread according to EN 50262. Included in each enclosure is a ground terminal. All enclosures can be supplied with a cover coupling for additional safety. Increased wiring space and mounting holes with slots are featured in this new line. These enclosures are also available for conduit entries for PG-thread. KS and CS enclosures have a compact size which allows for the installation of a 4 pole KH16/KHR16 ON/OFF switch or a KH20/KHR20 ON/OFF switch. The design, options and mounting are the same as those of the KL and CL enclosures.</p>	<p>KH16-KHR80</p>	<p>KL. CL. KS. CS.</p>	
			<p>Without cover interlock</p>	<p>0</p>
			<p>With cover interlock (The enclosure can only be opened at 9 o'clock position)</p>	<p>1</p>
			<p>With cover interlock (The enclosure can only be opened at 12 o'clock position)</p>	<p>2</p>

[< back to table of contents >](#)

Switch Function and Configuration

Function	KH16 KH20 KH25	KHR16 KHR20 KHR25	KH16B KH20B KH25B	KHR16B KHR20B KHR25B	KH32 KH40	KHR32 KHR40	KH63 KH80	KHR63 KHR80	Escutch. Plate	Code
----------	----------------------	-------------------------	-------------------------	----------------------------	--------------	----------------	--------------	----------------	-------------------	------

Types of Mounting

ON/OFF Switches 4 pole	E	E	E	E	E	E	E	E		<p>K400-600</p>
	FT2 FH3 VE VE2 KS./KL.	FT2 FH3 VE VE2 KS./KL.	VE	VE	FH3 VE VE2 KL.	FH3 VE VE2 KL.	FH3 VE VE2 KL.	FH3 VE VE2 KL.		
ON/OFF Switches 8 pole	E	E	E	E	E	E				<p>K800-600</p>
	VE	VE	VE KL.	VE KL.	VE	VE				
Double-throw Switches 4 pole	E	E	E	E	E					<p>K950-600</p>
	VE	VE	VE KL.	VE KL.	VE VE2					

Connection Diagrams

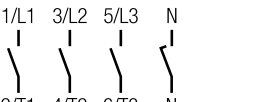
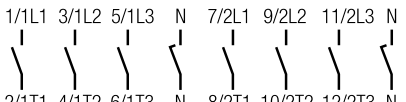
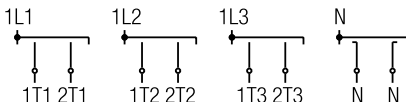
<p>ON/OFF Switches 4 pole</p> 	<p>ON/OFF Switches 8 pole</p> 	<p>Double-throw Switches 4 pole</p> 
--	--	--

Square and rectangular escutcheon plates are available for each size of switch. The escutcheon plate consists of a frame and a faceplate having the switch position which is then embossed with hot-foil backing. The escutcheon plate frame is an essential part of the switch and serves as a bearing surface for the handle. If the switch is to be mounted without an escutcheon plate we would recommend the handle bearing plate T100-04 which is available for switch types KH16B-KHR25B, KH32-KHR40 and KH63-KHR80. Escutcheon plates with special lettering are also available upon request.

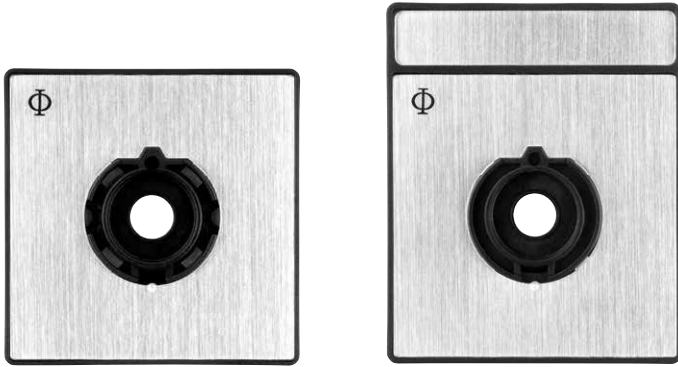

Escutcheon plate frame and faceplate can be obtained in different colors as listed below and defined in the first digit of the dash-number (1, 5, 6, 7):

Switch Type	Escutcheon Plate Frame	Handle	Escutcheon Plate Backing	Escutcheon Plate Lettering	Dash-number
KH/KHR	electro-gray	electro-gray	brushed alu	black	-100
KH/KHR	electro-gray	electro-gray	black	mat silver	-500
KH/KHR	black	black	brushed alu	black	-600
KH/KHR	black	black	black	mat silver	-700

Standard Escutcheon Plates

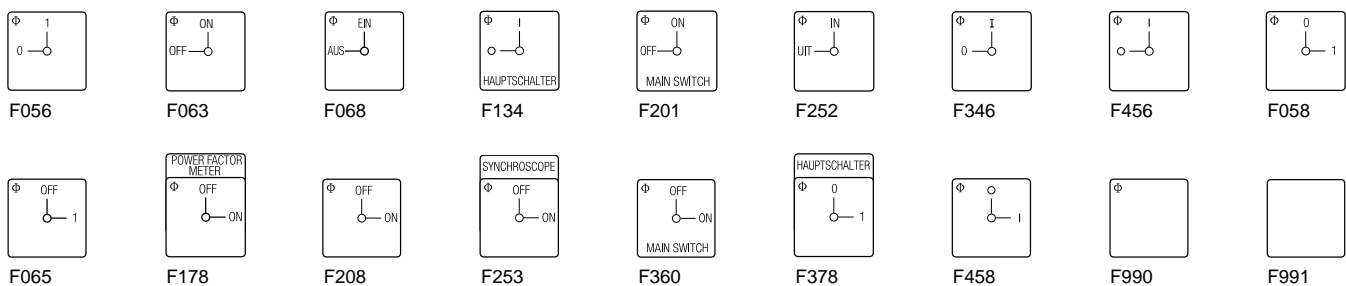







[< back to table of contents >](#)

Handles

KH, KHR Switches

Type	Color	Code	KH16- KH25	KHR16- KHR25	KH16B- KH25B	KHR16B- KHR25B	KH32- KHR40	KH63- KHR80
------	-------	------	---------------	-----------------	-----------------	-------------------	----------------	----------------

Black and Red are standard colours. White and Electro-Grey available on request.

I-Handle 	black	G251	●	●	●	●	●	●
	red	G252	●	●	●	●	●	●
	white	G253	●	●	●	●	●	●
	electro-gray	G257	●	●	●	●	●	●
B-Handle 	black	G521	●	●	●	●	●	●
	red	G522	●	●	●	●	●	●
	white	G523	●	●	●	●	●	●
	electro-gray	G527	●	●	●	●	●	●
R-Handle 	black	G001	●	●	●	●	●	●
	red	G002	●	●	●	●	●	●
	white	G003	●	●	●	●	●	●
	electro-gray	G007	●	●	●	●	●	●
F-Handle 	black	G221	●	●	●	●	●	●
	red	G222	●	●	●	●	●	●
	white	G223	●	●	●	●	●	●
	electro-gray	G227	●	●	●	●	●	●
L-Handle 	black	G501	—	—	●	●	●	●
	red	G502	—	—	●	●	●	●
	white	G503	—	—	●	●	●	●
	electro-gray	G507	—	—	●	●	●	●
P-Handle  KH16-KHR25 KH16B-KHR80	black	G211	●	●	●	●	●	●
	red	G212	●	●	●	●	●	●
	white	G213	●	●	●	●	●	●
	electro-gray	G217	●	●	●	●	●	●
K-Handle 	black	G411	—	—	●	●	●	●
	red	G412	—	—	●	●	●	●
	white	G413	—	—	●	●	●	●
	electro-gray	G417	—	—	●	●	●	●



[< back to table of contents >](#)

Protective Covers and Auxiliary Contacts	Type	Code
--	------	------

Protective Covers

	For mounting E	KH32-KHR40	K1 M160/45-E
	For mounting VE		K1 M160/45-VE
	For mounting E	KH63-KHR80	K1 M160/44-E
	For mounting VE		K1 M160/44-VE

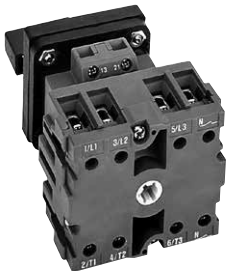
Cam-operated Auxiliary Contacts (mounting only at factory)

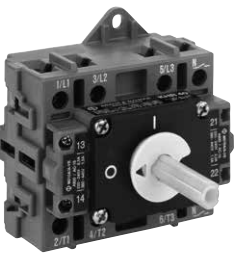
<p>For mounting E</p>  <p>KH16-KHR25B</p>	<p>Up to 4 cam-operated auxiliary contacts can be added to all switches (KH16-KHR25B max. 4/KH32-KHR80 max. 2).</p> <p>Select between a contact system with a rigid contact bridge for excellent AC-15 making and breaking capabilities or a contact system with gold contacts applicable for aggressive environments also.</p>	KH16-KHR80	M510A
 <p>KH32-KHR80</p>			
<p>For mounting VE</p> 			

[< back to table of contents >](#)

Auxiliary Contacts, Ground Terminal and Shaft Extensions	Type	Code
--	------	------

Lateral mounted Auxiliary Contacts

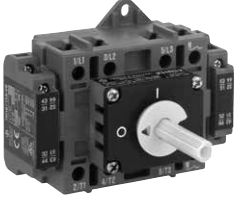

	Lateral mounted auxiliary contacts with 1 NO and 1 NC.				
	Standard contacts (nonoverlapping)	Terminal numbers			
		Attachment			
		left	right		
	For mounting E	(33-34, 41-42)	(53-54, 61-62)	KH16-	H010/A11-E H010/A11-VE
	For mounting VE	(31-32, 43-44)	(51-52, 63-64)	KHR25B	
	For mounting E	(33-34, 41-42)	(53-54, 61-62)	KH32-	H010/11A-E H010/11A-VE
	For mounting VE	(31-32, 43-44)	(51-52, 63-64)	KHR80	
Overlapping contacts					
	For mounting E	(33-34, 41-42)	(53-54, 61-62)	KH16-	H010/B11-E H010/B11-VE
	For mounting VE	(31-32, 43-44)	(51-52, 63-64)	KHR25B	
	For mounting E	(33-34, 41-42)	(53-54, 61-62)	KH32-	H010/11B-E H010/11B-VE
For mounting VE	(31-32, 43-44)	(51-52, 63-64)	KHR80		

Ground Terminal



		KH16- KHR80	H052
--	--	----------------	-------------

[< back to table of contents >](#)

Shaft Extensions



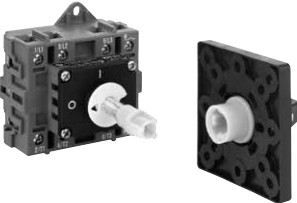
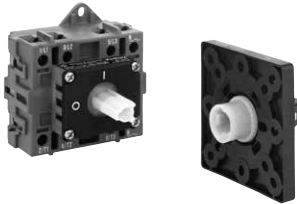
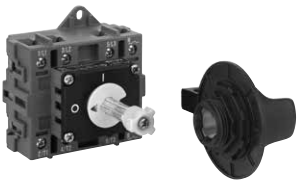
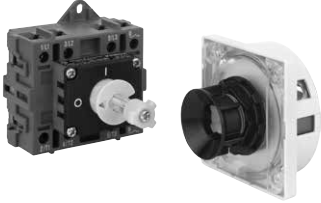
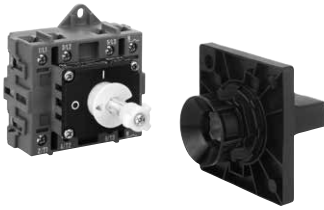

	With asymmetric profile	KH16- KHR80	L100¹
	Shaft length not adjustable		
	Shaft with adjustable length with set screw with shear ring		M004D³ M004³
	With square profile		L100A¹
	Shaft length not adjustable		
	Shaft with adjustable length with set screw		M004E²
Ordering data:		Free shaft length or dimension from mounting surface to cover.	

¹Available for switch types from KH16B. ²Available for switch types from KH32. ³Not available for KH..B.



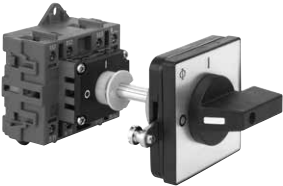

Simplified Door Clutch	Type	Code
 <p>The simplified door clutches are utilized primarily when the switch is mounted to the bottom of the enclosure and the handle and escutcheon plate are mounted on the cover.</p> <p>With shaft extension Front protection IP 40</p>	KH16-KHR80	M290/A3
 <p>With profile extension parts Front protection IP 65</p>		M290/A1.EF ²
 <p>With padlock device, single hole mounting 22 mm, protection IP 66. An additional aluminum shaft extension is required.</p>		V840E ¹
 <p>The cover disc is available in black, yellow and electro-gray. The handle may be supplied in black, red and electro-gray.</p>		V840G ¹ V840F ¹
 <p>Operation of the locking bar from the front. Available in black, red and electro-gray.</p>		V845
 <p>Centering device for simplified door clutches with single hole mounting and shaft extension Misalignment between the shaft and mounting are compensated in all 4 directions.</p>		M600 ¹
<p>Ordering data:</p>		

[< back to table of contents >](#)

¹Available for switch types from KH16B. ²Available for switch types from KH32.











Door Clutches	Type	Code																								
 <p>The M280 door clutch has an adjustable shaft and can be supplied with an interlock device.</p> <p>The following interlock programs are available:</p> <p>A = Without interlock by door clutch B = With interlock by door clutch C = With interlock by rods D = With interlock by door clutch and rods</p> <p>With protected profile</p> <p>shaft fixation with set screw Front protection IP 40 Front protection IP 66/67</p> <p>shaft fixation with shear ring Front protection IP 40 Front protection IP 66/67</p>  <p>Handle lockable with padlocks Protection IP 66 Selection of escutch. plate and handle color required:</p> <table border="1" data-bbox="528 1093 1161 1323"> <thead> <tr> <th>Escutcheon Plate</th> <th>Frame Plate</th> <th>Handle</th> <th>Lock Bar</th> </tr> </thead> <tbody> <tr> <td>A = brushed alu</td> <td>black</td> <td>black</td> <td>red</td> </tr> <tr> <td>B = brushed alu</td> <td>black</td> <td>red</td> <td>yellow</td> </tr> <tr> <td>C = brushed black</td> <td>black</td> <td>black</td> <td>red</td> </tr> <tr> <td>D = brushed black</td> <td>black</td> <td>red</td> <td>yellow</td> </tr> <tr> <td>E = yellow</td> <td>black</td> <td>red</td> <td>yellow</td> </tr> </tbody> </table> <p>The M700 is a padlock door clutch and a mechanical interlocking safety device. Using the device the electrical panel may be opened only when the switch is in the OFF position and no padlock is fitted. Note: Only in the ON position can knowledgeable personnel using a simple tool to defeat the interlock. The M700's flexibility allows for successful installation with as much as + or - 5 mm of misalignment between the shaft and door.</p>  <p>Standard handle and standard escutcheon plate Protection IP 66 The M700's flexibility allows for successful installation with as much as + or - 5 mm of misalignment between the shaft and door.</p>  <p>Unlock insert for the M700 to open the door in ON position. (After the locking has been made inactive, it is necessary to take effective precautions against an opening of the door by unauthorized persons.)</p>	Escutcheon Plate	Frame Plate	Handle	Lock Bar	A = brushed alu	black	black	red	B = brushed alu	black	red	yellow	C = brushed black	black	black	red	D = brushed black	black	red	yellow	E = yellow	black	red	yellow	<p>KH16-KHR80</p> <p>KH16B-KHR80</p>	<p>M280E M280E/.EF</p> <p>M280D M280D/.EF</p> <p>M700/.</p> <p>M701</p> <p>S1D M700 29</p>
Escutcheon Plate	Frame Plate	Handle	Lock Bar																							
A = brushed alu	black	black	red																							
B = brushed alu	black	red	yellow																							
C = brushed black	black	black	red																							
D = brushed black	black	red	yellow																							
E = yellow	black	red	yellow																							
<p>Ordering data:</p>	<p>Dimension from face of the switch to the cover or dimension from mounting surface to cover, the interlock program and the color selection.</p>																									

[< back to table of contents >](#)

Padlock Devices	Type	Code
<p>The padlock device is an integral part of the switch.</p>  <p>For 2 padlocks Operation of the locking bar from the bottom. Available in black, red and electro-gray.</p>  <p>For 4 padlocks Operation of the locking bar from the front. Available in black, red and electro-gray.</p> <p>Padlock device with integrated F- or B-handle. The cover disc is available in black, yellow and electro-gray. The handle may be supplied in black, red and electro-gray.</p>  <p>For 2 padlocks with F-handle</p>  <p>For 3 padlocks with F-handle with B-handle</p>  <p>For 4 padlocks with F-handle with B-handle</p> <p>Padlock devices with simplified door clutch and single hole mounting see page 32.</p>	<p>KH16-KHR80</p> <p>KH16-KHR25</p> <p>KH16B-KHR80</p>	<p>V840A</p> <p>V845</p> <p>V840D</p> <p>V840G V840G/B</p> <p>V840F/F V840F/B</p>
<p>Ordering data:</p>	<p>For V840 and V845 color selection required.</p>	

[< back to table of contents >](#)

Country	Authority	Mark or Standard	KH16 KH16B	KHR16 KHR16B	KH20 KH20B	KHR20 KHR20B	KH25 KH25B	KHR25 KHR25B	KH32 KHR32	KH40 KHR40	KH63 KHR63	KH80 KHR80
---------	-----------	------------------	---------------	-----------------	---------------	-----------------	---------------	-----------------	---------------	---------------	---------------	---------------

USA	Underwriters Laboratories	 or 	●	●	●	●	●	●	●	●	●	●
Canada	Canadian Standards Association	 ³ or 	●	●	●	●	●	●	●	●	●	●
Switzerland	Schweizerischer Elektrotechnischer Verein		+	+	+	+	+	+	+	+	+	+
Danmark	Danmarks Elektriske Materielkontrol		+	+	+	+	+	+	+	+	+	+
Norway	Norges Elektriske Materielkontrol		+	+	+	+	+	+	+	+	+	+
Sweden	Svenska Elektriska Materielkontrollanstalten		+	+	+	+	+	+	+	+	+	+
Finland	Sähkötar-kastuskeskus		+	+	+	+	+	+	+	+	+	+
Austria	Österreichischer Verband für Elektrotechnik		+	+	+	+	+	+	+	+	+	+
Federal Republic of Germany	Verband Deutscher Elektrotechniker	VDE 0660 ¹ VDE 0113 ¹	+	+	+	+	+	+	+	+	+	+
Great Britain	British Standards Institution	BS EN 60947 ¹	+	+	+	+	+	+	+	+	+	+
International Electrical Commission (IEC) Recommendation		IEC 60204-1 ² IEC 60947-3 ²	+	+	+	+	+	+	+	+	+	+
Russia Belarus Kazakhstan	Eurasian Conformity		● ●	+ +	● ●	+ +	● ●	+ +	● +	● +	● +	● +

[< back to table of contents >](#)

- Switch approved
- + Switch conforms to requirements

¹Industrial switchgear is not required to bear a symbol but must conform to requirements. By referring to the specific specification on the product the manufacturer implies that these requirements have been met.

²IEC does not operate an approval program.

³Approved by use of "UL Certification Services for Canada" (File No. E35541, Guide No. NLRV7 or NLRV8 respectively).

The switches of the KH/KHR-series are approved by UL and CSA as „disconnect switches for use in motor circuits“. UL approved terminals are required when making connection to switches having ring type terminations (KHR).

Selection Data	KH16	KHR16	KH20	KHR20	KH25	KHR25	KH32					KH63	KH80
	KH16B	KHR16B	KH20B	KHR20B	KH25B	KHR25B	KHR32	KH40	KHR40	KHR63	KHR80		

Rated Insulation Voltage U_i	IEC/EN/VDE ¹		V	800 ²	800 ²	800 ²	800 ²	800 ²	800 ²	800 ²	800 ²	800 ²	1000 ²	1000 ²	
	UL/Canada		V	600	600	600	600	600	600	600	600	600	600	600	600
Rated Impulse Withstand Voltage U_{imp}¹			kV	6	6	6	6	6	6	6	6	6	8	8	
Rated Thermal Current	IEC/EN/VDE		$I_{u, open} = I_{th}$	A	16	16	20	20	25	20	32	40	32	63	80
			$I_{the, enclosed}$	A	16	16	20	20	25	20	32	40	32	63	80
	UL/Canada			A	16	16	20	20	25	20	30	40	30	60	80
Rated Operational Current I_g															
AC-21A	Switching of resistive loads, including moderate overloads	IEC/EN/VDE	A	16	16	20	20	25	20	32	40	32	63	80	
AC-22A	Switching of combined resistive or low inductive loads, including moderate overloads	IEC/EN/VDE	A	16	16	20	20	25	20	32	40	32	63	80	
Ampere-Rating Resistive or low inductive loads		UL/Canada	A	16	16	20	20	25	20	30	40	30	60	80	
Rated Utilization Category			IEC/EN/VDE												
AC-3	Direct-on-line starting	3 phase 3 pole	220 V-240 V 380 V-440 V 500 V 660 V-690 V	kW	3	3	3,5	3,5	4	4	5,5	7,5	7,5	11	15
				kW	5,5	5,5	6,5	6,5	7,5	7,5	11	15	15	22	30
				kW	5,5	5,5	6,5	6,5	7,5	7,5	11	15	15	30	37
				kW	5,5	5,5	6,5	6,5	7,5	7,5	11	15	15	18,5	22
AC-23A	Frequent switching of motors or other high inductive loads	3 phase 3 pole	220 V-240 V 380 V-440 V 500 V 660 V-690 V	kW	4,5	4,5	5,5	5,5	7	5,5	9	11	9	18,5	23
				kW	7,5	7,5	10	10	12	10	16	20	16	30	40
				kW	10	10	12	12	15	13	20	25	20	40	55
				kW	13	13	15	15	17	17	22	25	25	30	37
DOL-Rating	Standard motor load (similar AC-3)	3 phase 3 pole	110 V-120 V 220 V-240 V 440 V-480 V 550 V-600 V	HP	1	1	1	1	1,5	1,5	2	3	3	7,5	10
				HP	2	2	2	2	3	3	5	7,5	7,5	20	25
				HP	5	5	5	5	7,5	7,5	10	15	15	30	40
				HP	5	5	5	5	7,5	7,5	10	15	15	40	50
Power loss per contact at I_u				W	0,2	0,2	0,3	0,3	0,3	0,3	0,4	0,6	0,4	1,5	2,7
Resistance to vibration ³				C	C	C	C	C	C	C	C	C	C	C	C
Resistance to shock ³				C	C	C	C	C	C	C	C	C	C	C	C
Short Circuit Protection															
Max. fuse size		(gL-characteristic)	A	25	25	35	35	35	35	35	50	50	80	100	
Rated short-time withstand current		(1s-current)	A	400	400	450	450	500	500	850	950	950	1200	1600	
Max. Permissible Wire Gage - Use copper wire only															
KH	For box terminal	Single-core or stranded wire	mm ²	6	-	6	-	6	-	10	10	-	35	35	
			AWG	10	-	10	-	10	-	8	8	-	2	2	
			Flexible wire sleeving in accordance with DIN46228	mm ²	4	-	4	-	4	-	6	6	-	25	25
			Flexible wire without sleeve	mm ²	4	-	4	-	4	-	6	6	-	25	25
			AWG	12	-	12	-	12	-	10	10	-	4	4	
KHR	Connection with insulated ring and fork type terminals		mm	-	3,2	-	3,2	-	3,2	3,7	-	3,7	5,2	5,2	
	Internal diameter \geq	External diameter \leq	mm	-	7,4	-	7,4	-	7,4	8,8	-	8,8	12,7	12,7	
Ambient Temperature															
Ambient Temperature⁴															
open at 100 % I_u/I_{th}															
enclosed at 100 % I_{the}															
				-5 °C											
				50 °C during 24 hours with peaks up to 55 °C											
				35 °C during 24 hours with peaks up to 40 °C											

[< back to table of contents >](#)

¹Valid for lines with grounded common neutral termination, overvoltage category III, pollution degree 3. Values for other supply systems on request.
²Suitable for no load switching applications (AC-20A) above 690 V. ³C: on request. ⁴Storage temperature: -40 °C to 85 °C (in case of temperature below -5 °C no shock load permissible).

Selection Data	Auxiliary contacts for: KH16-KHR80
-----------------------	---------------------------------------

Rated Insulation Voltage U_i		IEC/EN/VDE	V	440	
		UL/Canada	V	300	
Rated Thermal Current I_U/I_{th}		IEC/EN/VDE	A	10	
		UL/Canada	A	10	
Rated Operational Current I_e					
AC-21A	Switching of resistive loads, including moderate overloads	IEC/EN/VDE	A	10	
AC-15	Switching of control devices, contactors, valves etc.		110 V-240 V	A	2,5
			380 V-440 V	A	1,5
Pilot Duty	Heavy	UL/Canada		A300	
Ampere-Rating	Resistive or low inductive loads	UL/Canada	A	10	
Short Circuit Protection					
	Max. fuse size	(gL-characteristic)	A	10	
Max. Permissible Wire Gage - Use copper wire only					
	Single-core or stranded wire		mm ²	1,5 (2,5) ¹	
			AWG	14 (12) ¹	
	Flexible wire sleeving in accordance with DIN46228		mm ²	1,5 (2,5) ¹	
	Flexible wire without sleeve		mm ²	1,5 (2,5) ¹	
			AWG	16 (14) ¹	

[< back to table of contents >](#)

¹The values in brackets are valid for switches KH32-KHR80 E mounting.

Mounting

(Additional length for auxiliary contacts see page 42)

ON/OFF Switches 3 and 4 pole

E		A	B	C	D1	D2	D3	E	F	G	G1 ¹	H	L
	KG10A	48	36	4	11-15	5	-	-	48	48	-	50	48,2
		1.89	1.42	.16	.43-.59	.20	-	-	1.89	1.65	-	1.97	1.90
	KG10B	64	48	4	11-15	5	-	-	64	48	-	50	57,2
		2.52	1.89	.16	.43-.59	.20	-	-	2.52	1.65	-	1.97	2.25
	KG20, KG32	30	-	4	8-11	-	3,2	20	-	42	13,5	54	50,8
		1.18	-	.16	.31-.43	-	.13	.79	-	1.65	.53	2.13	2.00
	KG20A, KG32A	48	36	4	10-15	5	-	-	48	42	13,5	54	53,8
		1.89	1.42	.16	.39-.59	.20	-	-	1.89	1.65	.53	2.13	2.12
	KG20B, KG32B	64	48	4	10-15	5	-	-	64	42	13,5	54	53,8
		2.52	1.89	.16	.39-.59	.20	-	-	2.52	1.65	.53	2.13	2.12
KG41, KG64	48	36	4	10-15	5	-	-	64	50	16	64	60,5	
	1.89	1.42	.16	.39-.59	.20	-	-	2.52	1.97	.63	2.52	2.38	
KG41B, KG64B	64	48	4	10-15	5	-	-	64	50	16	64	60,5	
	2.52	1.89	.16	.39-.59	.20	-	-	2.52	1.97	.63	2.52	2.38	
KG80, KG100, KG105	64	48	4	10-15	5	-	-	70	70	22	80	70,6	
	2.52	1.89	.16	.39-.59	.20	-	-	2.76	2.76	.87	3.15	2.78	
KG80C, KG100C, KG105C	88	68	4	10-15	6	-	-	88	70	22	80	70,6	
	3.46	2.68	.16	.39-.59	.24	-	-	3.46	2.76	.87	3.15	2.78	

	A	B	C	D1	D2	G	G1 ¹	H	L	N	R	S	S1
KG125, KG160	88	68	5,5	13-17	6	112	38	108	96	-	-	-	-
	3.46	2.68	.22	.51-.67	.24	4.41	1.50	4.25	3.78	-	-	-	-
KG126, KG161	88	68	5,5	13-17	6	112	38	110	96	45	20	36	38
	3.46	2.68	.22	.51-.67	.24	4.41	1.50	4.33	3.78	1.77	.79	1.36	1.50
KG127, KG162	88	68	5,5	13-17	6	112	38	109	96	45	20	36	38
	3.46	2.68	.22	.51-.67	.24	4.41	1.50	4.29	3.78	1.77	.79	1.36	1.50
KG210, KG250, KG315	88	68	5,5	13-17	6	145	52,5	126	103	-	-	-	-
	3.46	2.68	.22	.51-.67	.24	5.71	2.07	4.96	4.05	-	-	-	-
KG211, KG212, KG251, KG252, KG316, KG317	88	68	5,5	13-17	6	145	52,5	126	103	50	26	44	52,5
	3.46	2.68	.22	.51-.67	.24	5.71	2.07	4.96	4.05	1.97	1.02	1.73	2.07

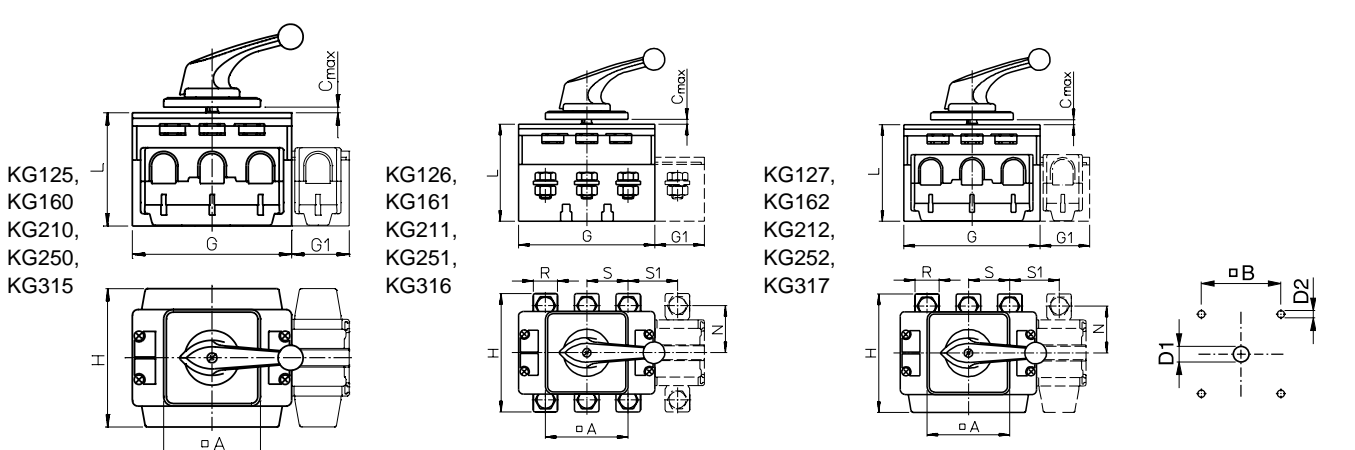

FT1, FT2

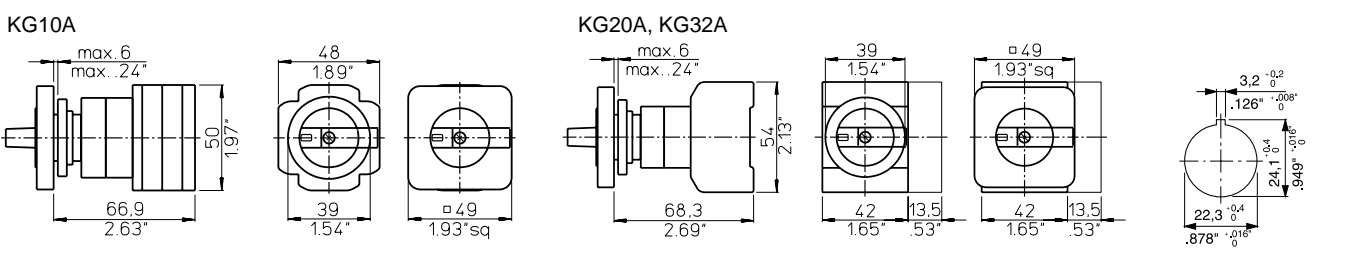

¹For ON/OFF switches 4 pole.

Mounting
(Additional length for auxiliary contacts see page 42)

ON/OFF Switches 3 and 4 pole

VE, VE1

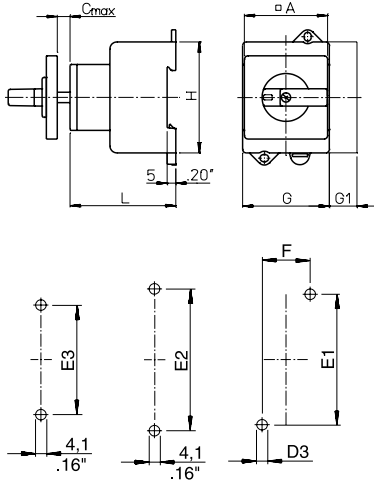

	A	B	C	D1	D2	D3	E1 ¹	E2 ¹	E3 ¹	F	G	G1 ²	H	L	M
KG10A	48	36	12	8-15	5	4,2	60	65	50	22	48	-	50	49,5	-
KG10B	64	48	29	10-15	5	4,2	60	65	50	22	48	-	50	56,5	-
KG20, KG32	30	-	12	8-11	3,2	4,1	60	-	-	22	42	13,5	54	50	20
KG20A, KG32A	48	36	12	8-15	5	4,1	60	-	-	22	42	13,5	54	50	-
KG20B, KG32B	64	48	13,5	10-15	5	4,1	60	-	-	22	42	13,5	54	50	-
KG41, KG64	48	36	12	10-15	5	4,1	70	-	-	25	50	16	64	61	-
KG41B, KG64B	64	48	13,5	10-15	5	4,1	70	-	-	25	50	16	64	61	-
KG80, KG100, KG105	64	48	13,5	10-15	5	5,2	90	-	-	25	70	22	80	68	-
KG80C, KG100C, KG105C	88	68	13,5	10-15	6	5,2	90	-	-	25	70	22	80	68	-

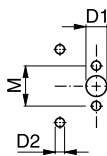

	A	B	C	D1	D2	D3	G	G1 ²	H	L ³	N	P	Q1	Q2	R	S	S1
KG125, KG160	88	68	16	13-17	6	6,4	112	38	108	91	-	36	59-61	59-61	-	-	-
KG126, KG161	3.46	2.68	.63	.51-.67	.24	.25	4.41	1.50	4.25	3.58	-	1.42	2.32-2.40	2.32-2.40	-	-	-
KG127, KG162	88	68	16	13-17	6	6,4	112	38	110	91	45	36	38-40	38-40	20	36	38
KG210, KG250, KG315	3.46	2.68	.63	.51-.67	.24	.25	4.41	1.50	4.29	3.58	1.77	1.42	1.50-1.57	1.50-1.57	.79	1.36	1.50
KG211, KG251, KG316	88	68	16	13-17	6	6,4	145	52,5	126	98	50	44	40-42	40-42	26	44	52,5
KG212, KG252, KG317	3.46	2.68	.63	.51-.67	.24	.25	5.71	2.07	4.96	3.85	1.97	1.73	1.57-1.63	1.57-1.63	1.02	1.73	2.07

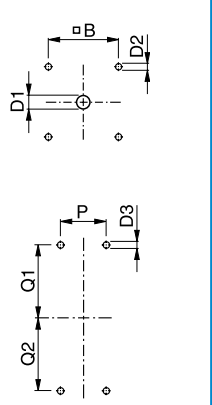
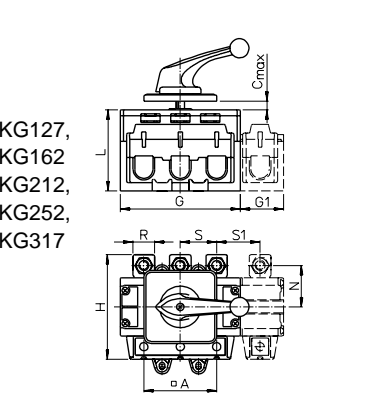
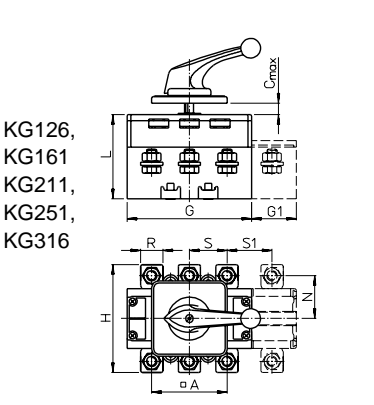
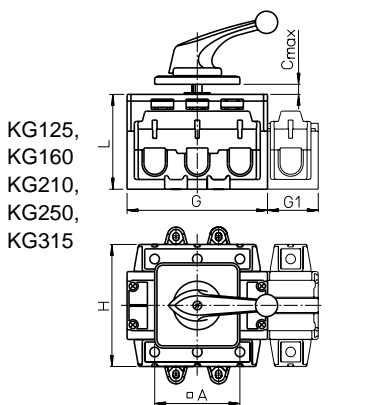

VE2

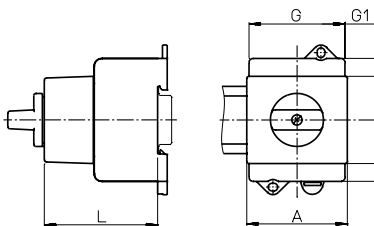

	A	B	G	G1 ²	L
KG20A, KG32A	43,7	45,4	42	13,5	56,5
KG41, KG64	1,72	1,79	1,65	.53	2,22
KG80, KG100, KG105	52,4	45,4	50	16	56,5
KG125-KG162	2,06	1,79	1,97	.63	2,22
	70	45	70	22	65
	2,76	1,77	2,76	.87	2,56
	112	45	112	38	98
	4,41	1,77	4,41	1,50	3,86

VE21

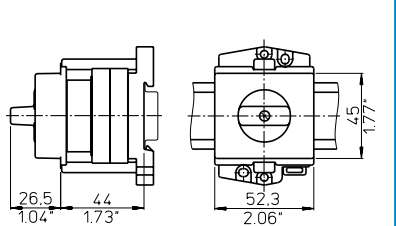

< back to table of contents >

¹Switches KG10A and KG10B allow use of E1, E2 or E3. ²For ON/OFF switches 4 pole. ³KG125-KG162 additional length for mounting VE1 = 7,5 mm/.30 inch.

Mounting

(Additional length for auxiliary contacts see page 42)

ON/OFF Switches 6 and 8 pole and Double-throw Switches

E	A	B	C	D1	D2	F	G	G1 ¹	H	L	
	KG10A	48	36	4	11-15	5	48	48	-	50	57,7
		1.89	1.42	.16	.43-.59	.20	1.89	1.89	-	1.97	2.27
	KG10B	64	48	4	11-15	5	64	48	-	50	66,7
		2.52	1.89	.16	.43-.59	.20	2.52	1.89	-	2.13	2.84
	KG20A, KG32A	48	36	4	10-15	5	48	84	13,5	54	61,3
		1.89	1.42	.16	.39-.59	.20	1.89	3.30	.53	2.13	2.41
	KG20B, KG32B	64	48	4	10-15	5	64	84	13,5	54	61,3
		2.52	1.89	.16	.39-.59	.20	2.52	3.31	.53	2.13	2.41
	KG41B, KG64B	64	48	4	10-15	5	64	100	16	64	66,5
		2.52	1.89	.16	.39-.59	.20	2.52	3.94	.63	2.52	2.62
KG80, KG100, KG105	64	48	4	10-15	5	70	140	22	80	81,8	
	2.52	1.89	.16	.39-.59	.20	2.76	5.51	.87	3.15	3.22	
KG80C, KG100C, KG105C	88	68	4	10-15	6	88	140	22	80	81,8	
	3.46	2.68	.16	.39-.59	.24	3.46	5.51	.87	3.15	3.22	

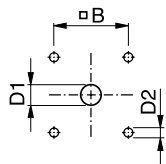

	A	B	C	D1	D2	G	G1 ¹	H	L	N	R	S	S1	S2
KG125, KG160	88	68	5,5	13-17	6	224	38	108	98	-	-	-	-	-
	3.46	2.68	.22	.51-.67	.24	8.82	1.50	4.25	3.86	-	-	-	-	-
KG126, KG161	88	68	5,5	13-17	6	224	38	110	98	45	20	36	38	20
	3.46	2.68	.22	.51-.67	.24	8.82	1.50	4.33	3.86	1.77	.79	1.42	1.50	.79
KG127, KG162	88	68	5,5	13-17	6	224	38	109	98	45	20	36	38	20
	3.46	2.68	.22	.51-.67	.24	8.82	1.50	4.29	3.86	1.77	.79	1.42	1.50	.79

KG125, KG160

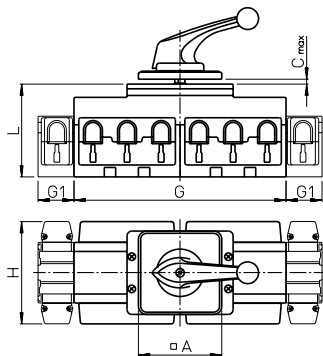

KG126, KG161

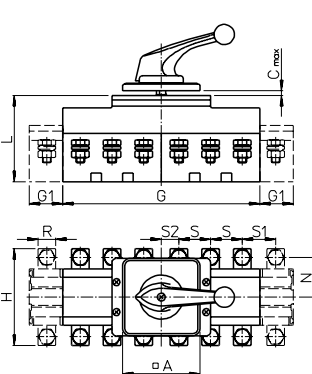

KG127, KG162

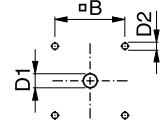
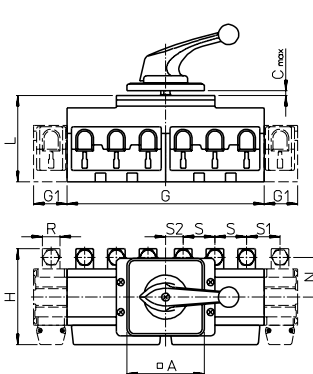

FT1, FT2

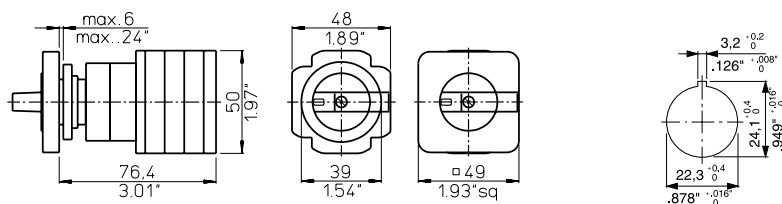

¹For ON/OFF switches 8 pole and double-throw switches 4 pole.

Mounting

(Additional length for auxiliary contacts see page 42)

ON/OFF Switches 6 and 8 pole and Double-throw Switches

VE, VE1

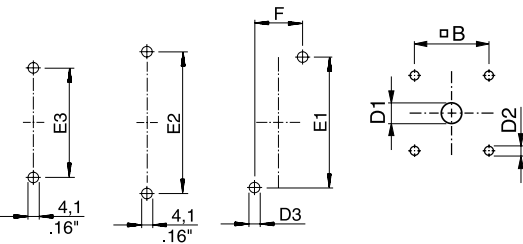
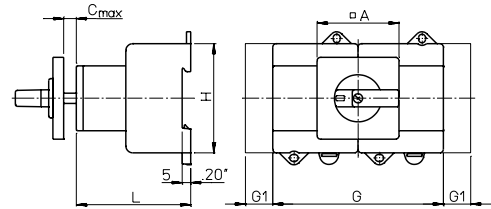

ON/OFF switches 6 pole
double-throw switches 3 pole

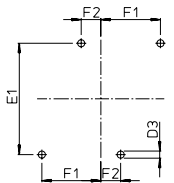

double-throw switches 4 pole

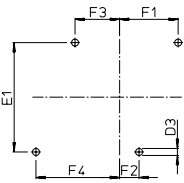

KG10A	48	36	12	8-15	5	4,2	60	65	50	22	-
KG10B	64	48	29	10-15	5	4,2	60	65	50	22	-
KG20A, KG32A	48	36	12	8-15	5	4,1	60	-	-	-	32
KG20B, KG32B	64	48	13,5	10-15	5	4,1	60	-	-	-	32
KG41B, KG64B	64	48	13,5	10-15	5	4,1	70	-	-	-	37,5
KG80, KG100	64	48	13,5	10-15	5	5,2	90	-	-	-	47,5
KG105	2,52	1,89	.53	.39-.59	.20	.21	3,54	-	-	-	1,87
KG80C, KG100C	88	68	13,5	10-15	6	5,2	90	-	-	-	47,5
KG105C	3,46	2,68	.53	.39-.59	.24	.21	3,54	-	-	-	1,87

	F2	F3	F4	G	G1 ²	H	L
KG10A	-	-	-	48	-	50	58,7
KG10B	-	-	-	48	-	50	65,7
KG20A, KG32A	10	23,5	45,5	84	13,5	54	57,5
KG20B, KG32B	.39	.92	1,79	3,31	.53	2,13	2,26
KG41B, KG64B	12,5	28,5	53,5	100	16	64	67
KG80, KG100,	22,5	44,5	69,5	140	22	80	79,2
KG105	.89	1,75	2,74	5,51	.87	3,15	3,12
KG80C, KG100C,	22,5	44,5	69,5	140	22	80	79,2
KG105C	.89	1,75	2,74	5,51	.87	3,15	3,12

	A	B	C	D1	D2	D3	G	G1 ²	H	L ³	N	P	Q1	Q2	R	S	S1	S2
KG125, KG160	88	68	16	13-17	6	6,4	224	38	108	93	-	76	59-61	59-61	-	-	-	-
KG126, KG161	88	68	16	13-17	6	6,4	224	38	110	93	45	76	38-40	38-40	20	36	38	20
KG127, KG162	88	68	16	13-17	6	6,4	224	38	109	93	45	76	38-40	59-61	20	36	38	20

KG125, KG160

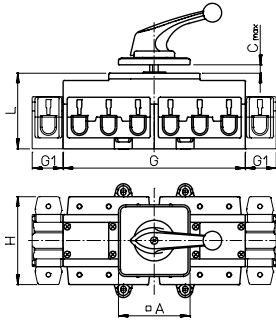

KG126, KG161

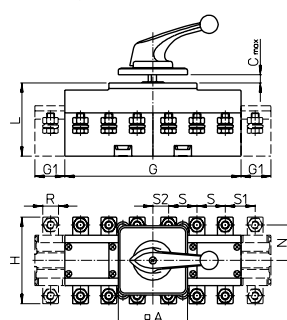

KG127, KG162

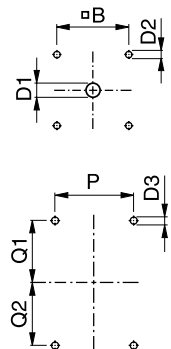
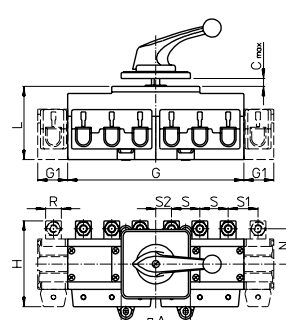

VE2

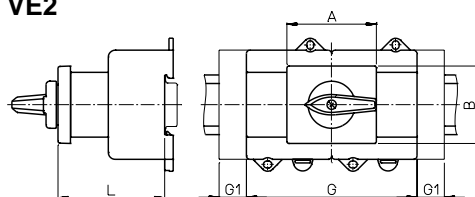

KG20A, KG32A	43,7	45,4	84	13,5	64
KG41B, KG64B	105,4	45,4	100	16	62,5
KG80, KG100,	70	45	140	22	76,2
KG105	2,76	1,77	5,51	.87	3,00

VE21

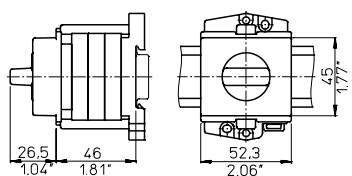

back to table of contents >

¹Switches KG10A and KG10B allow use of E1, E2 or E3. ²For ON/OFF switches 8 pole and double-throw switches 4 pole. ³Additional length for mounting VE1 = 7,5 mm/.30 inch.

Plastic Enclosures and Optional Extras

Switches in Plastic Enclosure

KL..., CL..., KS5., CS5.

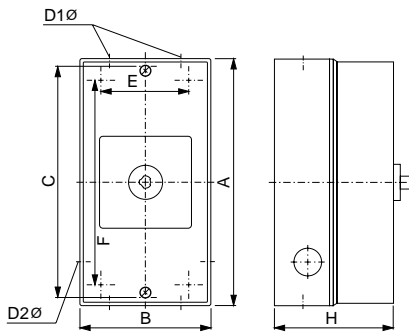

	3 and 4 pole	6 pole, Double-throw Switches 3 pole	8 pole, Double-throw Switches 4 pole	A	B	C	D1	D2	E	F	H
KG10 ¹	x	x	x	120	85	110	2x20/25 ²	20	-	-	80
				4.72	3.35	4.33	2x.79/.98 ²	.79	-	-	3.15
KG20 ¹	x			120	85	110	2x20/25 ²	20	-	-	80
				4.72	3.35	4.33	2x.79/.98 ²	.79	-	-	3.15
KG20, KG32	x			160	85	150	2x20	20	-	-	80
				6.30	3.35	5.91	2x.79	.79	-	-	3.15
KG20B, KG32B		x		190	100	178	2x25	25	-	-	91
				7.48	3.94	7.01	2x.98	.98	-	-	3.58
			x	250	145	-	2x40	25	124	229	107
				9.84	5.71	-	2x1.57	.98	4.88	9.02	4.21
KG41, KG64	x			190	100	178	2x25	25	-	-	91
				7.48	3.94	7.01	2x.98	.98	-	-	3.58
KG41B, KG64B		x	x	250	145	-	2x40	25	124	229	107
				9.84	5.71	-	2x1.57	.98	4.88	9.02	4.21
KG80, KG100, KG105	x			250	145	-	2x40	25	124	229	107
				9.84	5.71	-	2x1.57	.98	4.88	9.02	4.21

PFA-PFF5

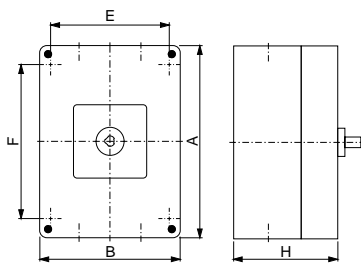

	3 and 4 pole	6 and 8 pole, Double-throw Switches	A	B	E	F	H
KG20A, KG32A, KG41, KG64	x		135	92	78	110	91
			5.31	3.62	3.07	4.33	3.58
KG20B, KG32B, KG41B, KG64B		x	180	140	128	150	98
			7.09	5.51	5.04	5.91	3.86
KG80, KG100	x		180	140	128	150	98
			7.09	5.51	5.04	5.91	3.86

Cam/rack-operated Auxiliary Contacts

E	VE	Mounting	M		
			allows use of 1 or 2 contacts	allows use of 3 or 4 contacts	
KG20-KG105C	KG20-KG105C	KG20, KG32 KG41, KG64 KG80, KG100 KG105	E/VE	9	25,8
				.35	1.02
			E/VE	10	30
				.39	1.18
			E	10	30
				.39	1.18
KG125-KG317	KG125-KG317	VE	47,2	10	30
			1.86	.39	1.18
		Mounting	M		
		E	21		
			.83		

Lateral mounted Auxiliary Contacts

	M
KG20, KG20A, KG20B, KG32, KG32A, KG32B	10
	.39
KG41, KG41B, KG64, KG64B	11
	.43
KG80, KG80C, KG100, KG100C, KG105, KG105C	11
	.43
KG125-KG317	14
	.55

¹KS5., CS5.

Optional Extras

Ground and Neutral Terminal, Additional Main Contact



	<u>M</u>
KG20, KG20A, KG20B, KG32, KG32A, KG32B	13,5 .53
KG41, KG41B, KG64, KG64B	16 .63
KG80, KG80C, KG100, KG100C, KG105, KG105C	22 .87
KG125, KG126, KG127, KG160, KG161, KG162	38 1.50
KG210, KG211, KG212, KG250, KG251, KG252, KG315, KG316, KG317	52,5 2.07

Protective Cover



	<u>A</u>
KG10A, KG10B	30 1.18
KG20, KG20A, KG20B, KG32, KG32A, KG32B	47 1.85
KG41, KG41B, KG64, KG64B	49 1.93
KG80, KG80C, KG100, KG100C, KG105, KG105C	66 2.60

With box terminal

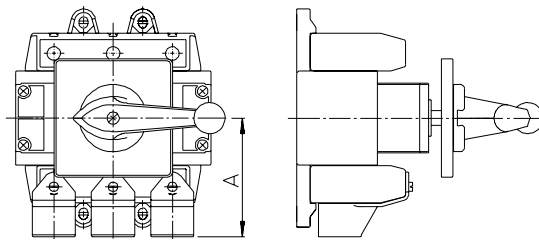

	<u>A</u>
KG125-KG162 with box terminal	76,2 3.00
KG125-KG162 with bolt terminal	112 4.41
KG210-KG317 with box terminal	88 3.46
KG210-KG317 with bolt terminal	109,5 4.29

With bolt terminal

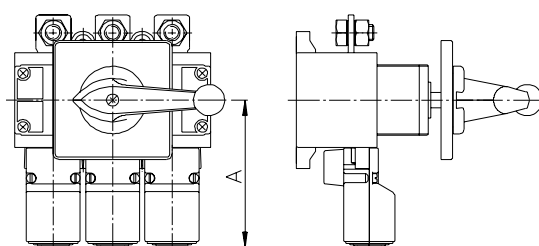

Optional Extras

Shaft Extension

L100, L100A

L1 = Free shaft length

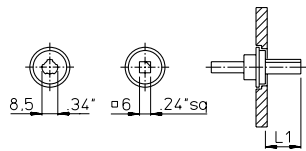

	Mounting	L1								
		L1	L1	L1	L1	L1	L1	L1	L1	L1
KG10B	E	19	23	27	32	37	42	47	52	57
	VE	.75	.91	1.06	1.26	1.46	1.65	1.85	2.05	2.24
KG20B, KG32B	E	11,5	16,5	20,5	24,5	29,5	34,5	39,5	44,5	49,5
	VE	.45	.65	.81	.96	1.16	1.36	1.56	1.75	1.95
KG41B, KG64B	E	13,5	17,5	21,5	26,5	31,5	36,5	41,5	46,5	51,5
	VE	.53	.69	.85	1.04	1.24	1.44	1.63	1.83	2.03
KG80, KG80C KG100, KG100C KG105, KG105C	E	13,5	17,5	21,5	26,5	31,5	36,5	41,5	46,5	51,5
	VE	.53	.69	.85	1.04	1.24	1.44	1.63	1.83	2.03

	Mounting	L1	L1	L1	L1	L1	L1	L1	L1	
KG10B	E	62	67	72	77	82	87	92	97	102
	VE	2.44	2.64	2.83	3.03	3.23	3.43	3.62	3.82	4.02
KG20B, KG32B	E	54,5	59,5	64,5	69,5	74,5	79,5	84,5	89,5	94,5
	VE	2.15	2.34	2.54	2.74	2.93	3.13	3.33	3.52	3.72
KG41B, KG64B	E	56,5	61,5	66,5	71,5	76,5	81,5	86,5	91,5	96,5
	VE	2.22	2.42	2.62	2.81	3.01	3.21	3.41	3.60	3.80
KG80, KG80C KG100, KG100C KG105, KG105C	E	56,5	61,5	66,5	71,5	76,5	81,5	86,5	91,5	96,5
	VE	2.22	2.42	2.62	2.81	3.01	3.21	3.41	3.60	3.80

M004, M004A, M004D, M004E

L1 = Free shaft length

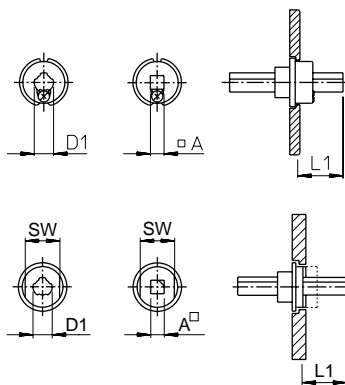

	Mounting	L1					D1	A	SW
		L1 ¹	L1	L1	L1	L1			
KG10A	E, VE	-	21-41	41-61	61-81	81-101	6	-	12
			.83-1.61	1.61-2.40	2.40-3.19	3.19-3.98	.24	-	.47
KG20A, KG32A	E	-	34,5-38	54,5-58	74,5-78	94,5-98	6	-	12
	VE	-	1.36-1.50	2.15-2.28	2.93-3.07	3.72-3.86	.24	-	.47
KG41B, KG64B	E	29,5-35,5	43-49	63-69	83-89	103-109	8,5	6	16
	VE	1.16-1.40	1.69-1.93	2.48-2.72	3.27-3.50	4.06-4.29	.33	.24	.63
KG80, KG80C KG100, KG100C KG105, KG105C	E	25,5-31,5	39-45	59-65	79-85	99-105	8,5	6	16
	VE	1.00-1.24	1.54-1.77	2.32-2.56	3.11-3.35	3.90-4.13	.33	.24	.63
KG125, KG126 KG127, KG160 KG161, KG162	E	39-53	69-83	99-113	129-143	159-173	11,2	8	22
	VE	1.54-2.09	2.72-3.27	3.90-4.45	5.08-5.63	6.26-6.81	.44	.32	.87
KG210, KG211 KG212, KG250 KG251, KG252 KG315, KG316 KG317	E	38-52	68-82	98-112	128-142	158-172	11,2	8	22
	VE	1.50-2.03	2.68-3.23	3.86-4.41	5.04-5.59	6.22-6.77	.44	.32	.87

¹Only for square shaft

Optional Extras

Simplified Door Clutches

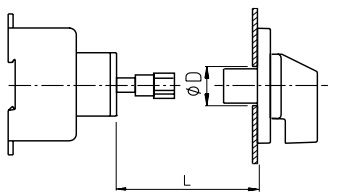

M290/A3, M290/A3.EF L = Standard length for switches of mounting VE

	L	L	L	L	L	D ¹
KG10A	37-57	57-77	77-97	97-117	-	18
	1.46-2.24	2.24-3.03	3.03-3.82	3.82-4.61	-	.71
KG20A, KG32A	55-68	75-88	95-108	115-128	-	18
	2.17-2.68	2.95-3.46	3.74-4.25	4.53-5.04	-	.71
KG41B, KG64B	60-70	80-90	100-110	120-130	-	18
	2.36-2.76	3.15-3.54	3.94-4.33	4.72-5.12	-	.71
KG80, KG100	56-68	76-88	96-108	116-128	-	18
KG105	2.20-2.68	2.99-3.46	3.78-4.25	4.57-5.04	-	.71

¹For KG10A, KG20A and KG32A with M290/A3.EF: 22/ 87

M290/A1.EF L = Standard length for switches of mounting VE

	L	L	L	L	L	D
KG41B, KG64B	27-31	27-38	32-45	41-54	47-60	56-69
	1.06-1.22	1.06-1.50	1.26-1.77	1.61-2.13	1.85-2.36	1.97-2.72
KG80, KG100	27-32	27-40	33-47	42-55	48-62	57-70
KG105	1.06-1.26	1.06-1.57	1.30-1.85	1.65-2.17	1.89-2.44	2.24-2.76

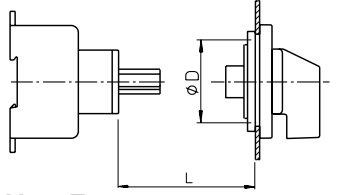

V840E

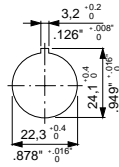
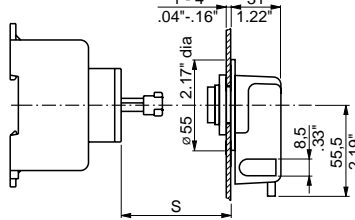

	S	
	min.	max.
KG10B	23	106
	.91	4.17
KG20B, KG32B	24,5	110
	.96	4.33
KG41B, KG64B	20	108
	.79	4.25
KG80, KG100	23	109
KG105	.91	4.29
KG125-KG317	21	110
	.83	4.33

V840G/V840F

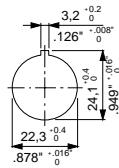
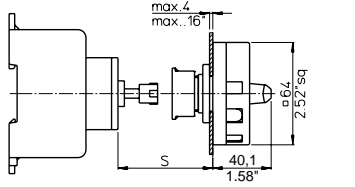

	S	
	min.	max.
KG10B	30	115
	1.02	4.49
KG20B, KG32B	27,5	113
	1.08	4.45
KG41B, KG64B	39,5	124
	1.56	4.88
KG80, KG100	27,5	122
KG105	1.08	4.80

V845

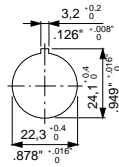
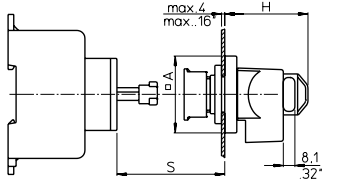

	A	H	S	
			min.	max.
KG10A	48	52	30	115
	1.89	2.05	1.18	4.53
KG10B	64	58	26	114
	2.52	2.28	1.02	4.49
KG20A, KG32A	48	52	50,5	119
	1.89	2.05	1.99	4.69
KG20B, KG32B	64	58	27,5	113
	2.52	2.28	1.08	4.45
KG41B, KG64B	64	58	39,5	124
	2.52	2.28	1.56	4.88
KG80, KG100	64	58	27,5	122
KG105	2.52	2.28	1.08	4.80

M600

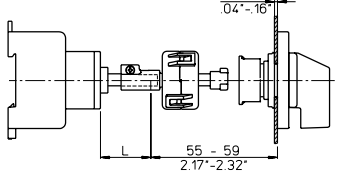

L see L100, M004D, M004, page 44.

Door Clutches

M700/.

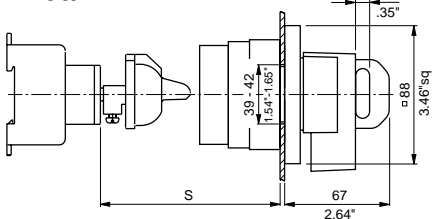

M701

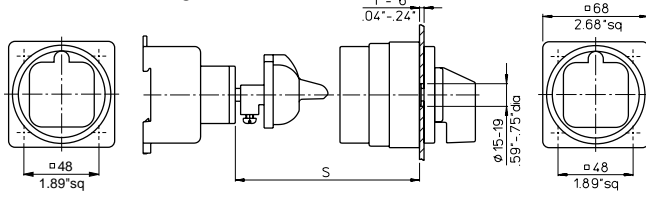

	S
KG10B	80
	3.15
KG20B, KG32B	61,5
	2.42
KG41B, KG64B	61,5
	2.42
KG80, KG100	61,5
KG105	2.42
KG125-KG317	61,5
	2.42

Optional Extras

Simplified Door Clutches

M810

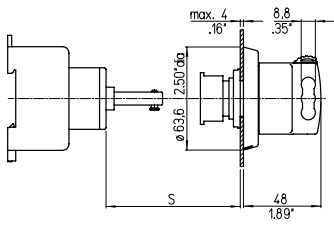

M800

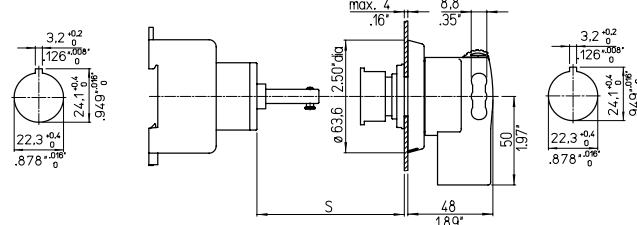

M810, M800

		S
KG41B, KG64B	3-pole	59 2.32
	6-pole	57 2.24
KG80, KG100 KG105	3-pole	56 2.20
	6-pole	53 2.09
KG125-KG317		56 2.20

KG10A, KG20A, KG32A

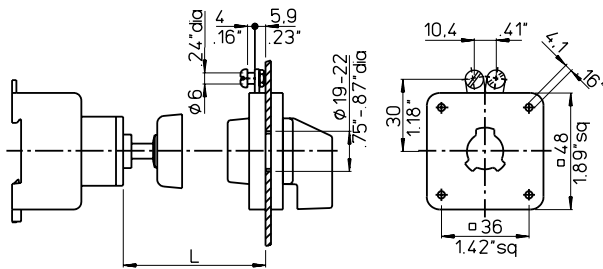

M280D, M280D/.EF, M280E, M280E/.EF

L = Standard length for switches of mounting VE

	L	L	L	L
KG10A	36-55 1.42-2.17	56-75 2.20-2.95	75-95 2.99-3.74	96-116 3.78-4.57
KG20A, KG32A	58,5-66 2.30-2.60	78,5-86 3.09-3.50	98,5-106 3.88-4.17	118,5-126 4.67-4.96

KG10B, KG20B, KG32B, KG41B, KG64B, KG80, KG100, KG105

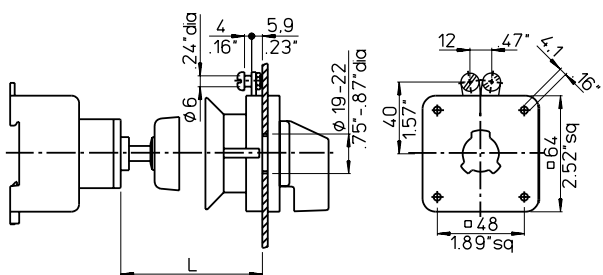

	L	L	L	L
KG10B	32-57 1.26-2.24	58-77 2.28-3.03	78-97 3.07-3.82	98-118 3.86-4.65
KG20B, KG32B	57,5-65 2.26-2.56	77,5-85 3.05-3.35	97,5-105 3.84-4.13	117,5-125 4.63-4.92
KG41B, KG64B	62-72 2.44-2.83	82-92 3.23-3.62	102-112 4.02-4.41	122-132 4.80-5.20
KG80, KG100 KG105	60-70 2.36-2.76	80-90 3.15-3.54	100-110 3.94-4.33	120-130 4.72-5.12

KG125-KG317

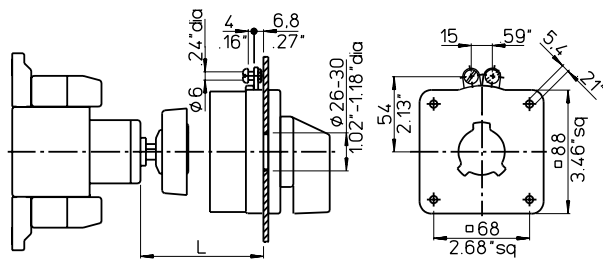

	L	L	L	L
KG125-KG317	93-109 3.66-4.29	123-139 4.84-5.47	153-169 6.02-6.65	183-199 7.20-7.83

M280B/., M280B/.EF

L = Standard length for switches of mounting VE

	L	L	L	L
KG41, KG64	26-34 1.02-1.34	41-49 1.61-1.93	56-64 2.20-2.52	71-79 2.80-3.11

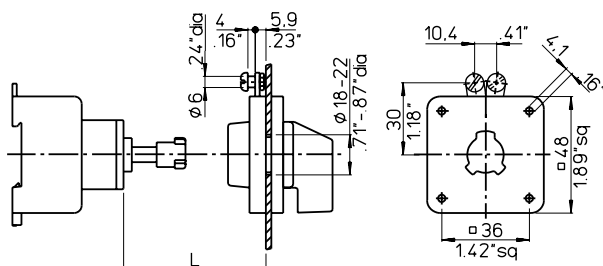

< back to table of contents >

Optional Extras

Padlock Devices, Additional Module for Motor Control Center (MCC), Angular drive

V840A

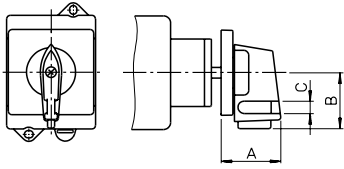

KG10A, KG20A, KG32A, KG41
KG64
KG10B, KG20B, KG32B, KG41B
KG64B, KG80, KG100, KG105

A	B	C
32,9	31,5	5
1.30	1.24	.20
41,6	40	7
1.64	1.57	.28

V840B

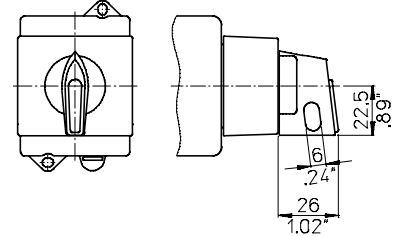

V845

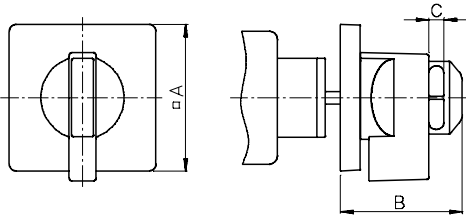

KG10A, KG20A, KG32A, KG41
KG64
KG10B, KG20B, KG32B, KG41B
KG64B, KG80, KG100, KG105
KG80C, KG100C, KG105C
KG125-KG317

A	B	C
48	51	7,2
1.89	2.01	.28
64	58	8,1
2.52	2.28	.32
88	73	9
3.47	2.87	.35

V840D

KG10A, KG20A, KG32A, KG41, KG64

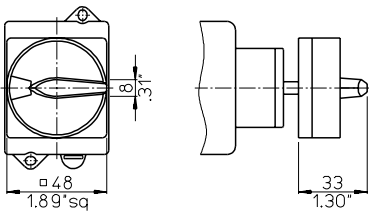

V840D

KG80C, KG100C, KG105C, KG125-KG162

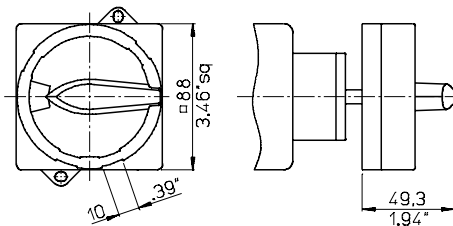

V840G/B, V840F/B

KG10B, KG20B, KG32B, KG41B, KG64B,
KG80, KG100, KG105

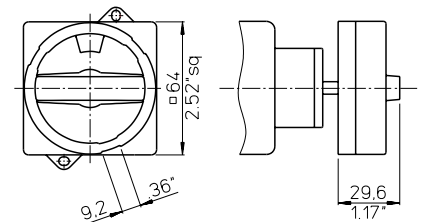

V840G, V840F/F

KG10B, KG20B, KG32B, KG41B, KG64B,
KG80, KG100, KG105

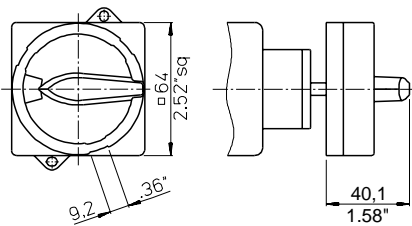

V840H/.E

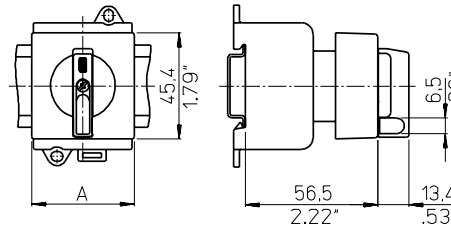

	A
KG20A, KG32A	43,7
	1.72
KG41, KG64	52,4
	2.06

V840VE

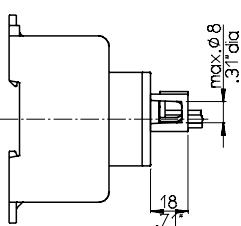

V500

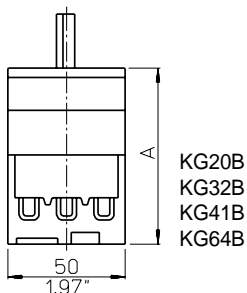

KG20B
KG32B
KG41B
KG64B

A
69,5
2.74
75
2.95

M330

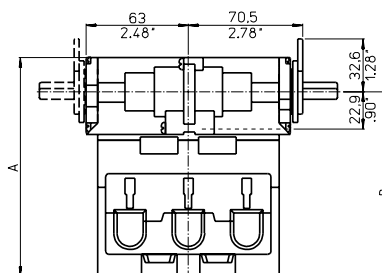

A	B	
KG125-	135	113,9
KG162	5.31	4.48
KG210-	142	120,9
KG317	5.59	4.76

Mounting

(Additional length for auxiliary contacts see page 50)

ON/OFF Switches 4 pole

E

	A	B	C	D1	D2 ¹	E	F	G	H	L
KH16-KHR25	48	36	4	10-15	5/3,5	30	12,2	60	56	49
	1.89	1.42	.16	.39-.59	.20/.14	1.18	.48	2.36	2.20	1.93
KH16B-KHR25B	64	48	4	10-15	5/3,5	30	12,2	60	56	49
	2.52	1.89	.16	.39-.59	.20/.14	1.18	.48	2.36	2.20	1.93
KH32, KHR32, KH40, KHR40	64	48	4	10-15	5/3,5	30	12,2	70	62	54
	2.52	1.89	.16	.39-.59	.20/.14	1.18	.48	2.76	2.44	2.13
KH63, KHR63 KH80, KHR80	64	48	4	10-15	5/4,5	37	14	86	90	62
	2.52	1.89	.16	.39-.59	.20/.18	1.46	.55	3.39	3.54	2.44

¹Dimensions after the slash are valid for two hole panel mounting

**FT2
FH3**

	A	G	H	L
KH16-KHR25 FT2	49	60	56	63,5
	1.93	2.36	2.20	2.50
KH16-KHR25 FH3	64	60	56	63,5
	2.52	2.36	2.20	2.50
KH32, KHR32, KH40, KHR40 FH3	64	70	62	68,7
	2.52	2.76	2.44	2.70
KH63, KHR63, KH80, KHR80 FH3	64	86	90	77,1
	2.52	3.39	3.54	3.04

VE

	A	B	C	D1	D2	D3	E	F	G	H	L
KH16-KHR25	48	36	12	8-15	5	4,2	60	22	60	56	47
	1.89	1.42	.47	.31-.59	.20	.17	2.36	.86	2.36	2.20	1.85
KH16B-KHR25B	64	48	13,5	10-15	5	4,2	60	22	60	56	47
	2.52	1.89	.53	.39-.59	.20	.17	2.36	.86	2.36	2.20	1.47
KH32, KHR32, KH40, KHR40	64	48	25,5	10-15	5	4,1	70	25	70	62	53,5
	2.52	1.89	1.00	.39-.59	.20	.16	2.76	.98	2.76	2.44	2.11
KH63, KHR63, KH80, KHR80	64	48	25,5	10-15	5	4,1	90	25	86	90	59,5
	2.52	1.89	1.00	.39-.59	.20	.16	3.54	.98	3.39	3.54	2.34

VE2

	A	B	G	L
KH16-KHR25	43,7	45,4	60	53,5
	1.72	1.79	2.36	2.11
KH32, KHR32 KH40, KHR40	70,4	45,4	70	54,7
	2.77	1.79	2.76	2.15
KH63, KHR63 KH80, KHR80	70,4	45,4	86	61,7
	2.77	1.79	3.39	2.43

[< back to table of contents >](#)

Mounting

(Additional length for auxiliary contacts see page 50)

ON/OFF Switches 8 pole and Double-throw Switches

E

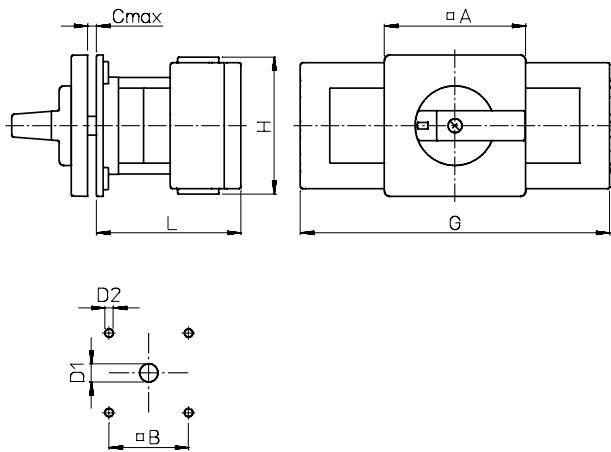

	A	B	C	D1	D2	G	H	L
KH16-KHR25	48	36	4	10-15	5	120,1	56	60
	1.89	1.42	.16	.39-.59	.20	4.73	2.20	2.36
KH16B-KHR25B	64	48	4	10-15	5	120,1	56	60
	2.52	1.89	.16	.39-.59	.20	4.73	2.20	2.36
KH32, KHR32 KH40, KHR40	64	48	4	10-15	5	140,1	62	65,4
	2.52	1.89	.16	.39-.59	.20	5.52	2.44	2.57

[< back to table of contents >](#)

VE

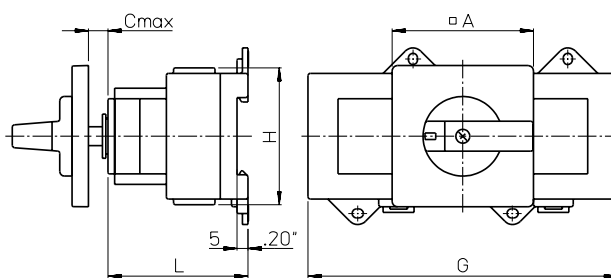

	A	C	G	H	L
KH16-KHR25	48	12	120,1	56	58
	1.89	.47	4.73	2.20	2.28
KH16B-KHR25B	64	13,5	120,1	56	58
	2.52	.53	4.73	2.20	2.28
KH32, KHR32 KH40, KHR40	64	13,5	140,1	62	63,4
	2.52	.53	5.52	2.44	2.50

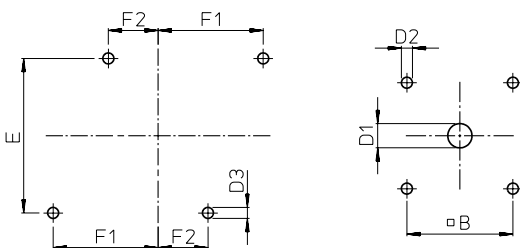

	B	D1	D2	D3	E	F1	F2
KH16-KHR25	36	10-15	5	4,2	60	41	19
	1.42	.39-.59	.20	.17	2.36	1.61	.75
KH16B-KHR25B	48	10-15	5	4,2	60	41	19
	1.89	.39-.59	.20	.17	2.36	1.61	.75
KH32, KHR32 KH40, KHR40	48	10-15	5	4,1	70	47,5	22,5
	1.89	.39-.59	.20	.16	2.76	1.87	.89

VE2

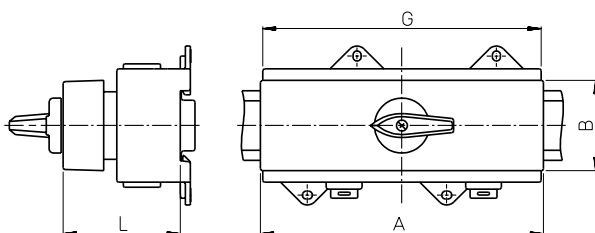

	A	B	G	L
KH32 KH40	142,4	45,4	140,1	60,9
	5.61	1.79	5.52	2.40

Optional Extras

Protective Cover

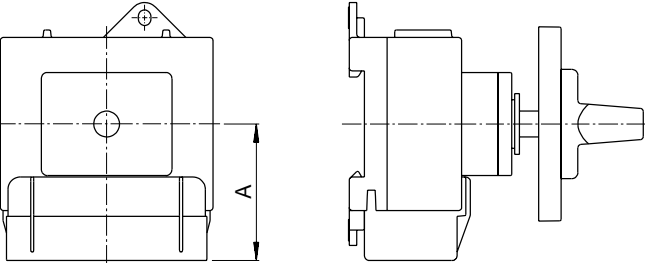

	A
KH32-KHR40	45 1.77
KH63-KHR80	68,5 2.70

Cam/rack-operated Auxiliary Contacts

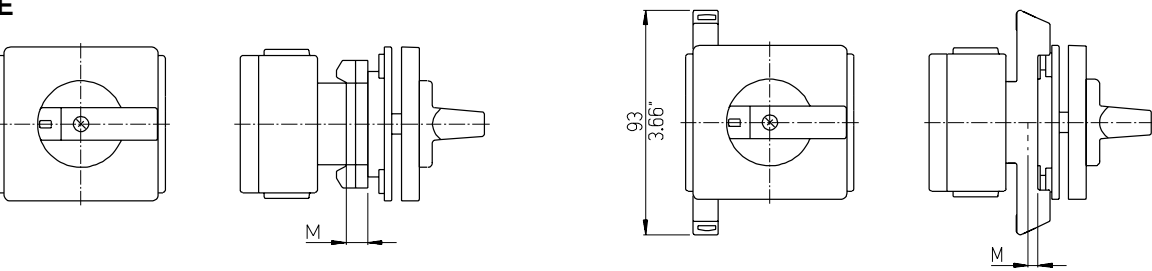

		M
KH16-KHR25B	1 or 2 contacts	9 .35
	3 or 4 contacts	25,8 1.02
KH32, KHR32, KH40, KHR40	1 or 2 contacts	0
	KH63, KHR63, KH80, KHR80	0

Lateral mounted Auxiliary Contacts

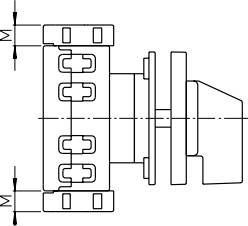

	M
KH16-KHR25B	10 .39
	KH32, KHR32, KH40, KHR40
KH63, KHR63, KH80, KHR80	

Ground Terminal

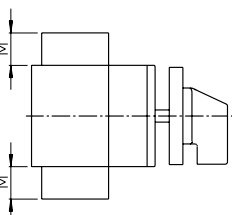

	M
KH16-KHR25B	13,5 .53
	KH32, KHR32, KH40, KHR40
KH63, KHR63, KH80, KHR80	

[< back to table of contents >](#)

Optional Extras

Switches in Plastic Enclosure

KL..., CL..., KS..., CS..

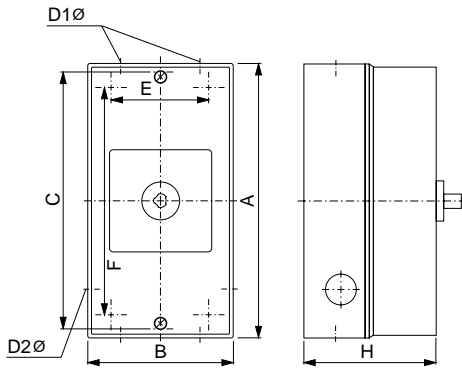

	A	B	C	D1	D2	E	F	H
KH16 - KHR25	120	85	110	2x20/25 ¹	20	-	-	80
	4.72	3.35	4.33	2x.79/.98 ¹	.79	-	-	3.15
KH16 - KHR25	160	85	150	2x25	20	-	-	80
	6.30	3.35	5.91	2x.98	.79	-	-	3.15
KH32 - KHR40	190	100	178	2x25	25	-	-	91
	7.48	3.94	7.01	2x.98	.98	-	-	3.58
KH63 - KHR80	250	145	-	2x40	25	124	229	107
	9.84	5.71	-	2x1.57	.98	4.88	9.02	4.21
KH16B - KHR25B	250	145	-	2x40	25	124	229	107
	9.84	5.71	-	2x1.57	.98	4.88	9.02	4.21

¹CS... 2x20, 2 x .79

Shaft Extension

L100, L100A

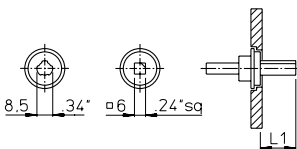

L1 = Free shaft length

Mounting	L1																		
	L1	L1	L1	L1	L1	L1	L1	L1	L1	L1	L1	L1	L1	L1	L1	L1	L1	L1	
KH16B-KHR25B	E	11,5	16,5	20,5	24,5	29,5	34,5	39,5	44,5	49,5	54,5	59,5	64,5	69,5	74,5	79,5	84,5	89,5	94,5
		.45	.65	.81	.96	1.16	1.36	1.56	1.75	1.95	2.15	2.34	2.54	2.74	2.93	3.13	3.33	3.52	3.72
VE		18	23	27	31	36	41	46	51	56	61	66	71	77	81	86	91	96	101
		.71	.91	1.06	1.22	1.42	1.61	1.81	2.01	2.20	2.40	2.60	2.80	3.03	3.19	3.39	3.58	3.78	3.98
KH32, KHR32, KH40, KHR40, KH63, KHR63, KH80, KHR80	E	14,3	18,3	22,3	27,3	32,3	37,3	42,3	47,3	52,3	57,3	62,3	67,3	72,3	77,3	82,3	87,3	92,3	97,3
		.56	.72	.88	1.07	1.27	1.47	1.67	1.86	2.06	2.26	2.45	2.65	2.85	3.04	3.24	3.44	3.63	3.83
VE		19,8	23,8	27,8	32,8	37,8	42,8	47,8	52,8	57,8	62,8	67,8	72,8	77,8	82,8	87,8	92,8	97,8	102,8
		.78	.94	1.09	1.29	1.49	1.69	1.88	2.09	2.28	2.47	2.67	2.87	3.06	3.26	3.46	3.65	3.85	4.05

M004D, M004E

M004, M004A

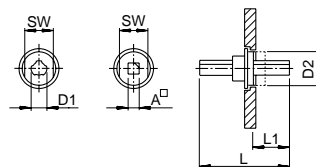
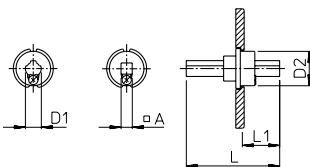

L = Shaft length
L1 = Free shaft length max.
¹ = Only for square shaft

Mounting	L ¹		L		L		L		L		D1	D2	A	SW	
	L ¹	L ¹	L	L ¹	L	L ¹	L	L ¹	L	L ¹					
KH16-KHR25	E	-	-	60	11-38	80	31-58	100	51-78	120	71-98	6	13.8	-	12
				2.36	.43-1.50	3.15	1.22-2.28	3.94	2.01-3.07	4.72	2.80-3.86	.24	.54	-	.47
VE		-	-	60	18-45	80	38-65	100	58-85	120	78-105	6	13.8	-	12
				2.36	.71-1.77	3.15	1.50-2.56	3.94	2.28-3.35	4.72	3.07-4.13	.24	.54	-	.47
KH32, KHR32, KH40, KHR40, KH63, KHR63, KH80, KHR80	E	56,5	3-36	70	17-49	90	37-69	110	57-89	130	77-109	8,5	18,5	6	16
		2.22	.12-1.42	2.76	.67-1.93	3.54	1.46-2.72	4.33	2.24-3.50	5.12	3.03-4.29	.34	.73	.24	.63
VE		56,5	8-41	70	22-55	90	42-75	110	62-95	130	82-115	8,5	18,5	6	16
		2.22	.31-1.61	2.76	.87-2.17	3.54	1.65-2.95	4.33	2.44-3.74	5.12	3.23-4.53	.34	.73	.24	.63

Optional Extras

Simplified Door Clutches

M290/A3, M290/A3.EF

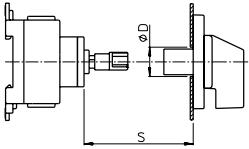

S = Standard length for switches of mounting VE

	S	S	S	S	D
KH16-KHR25	34,5-61,5 1.36-2.42	54,5-81,5 2.15-3.21	74,5-101,5 2.93-4.00	94,5-121,5 3.72-4.78	18 .71
KH32, KHR32, KH40, KHR40, KH63, KHR63, KH80, KHR80	28-55 1.10-2.17	55-75 2.17-2.95	75-95 2.95-3.74	95-115 3.74-4.53	18 .71

M290/A1.EF

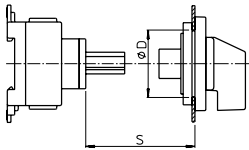

S = Standard length for switches of mounting VE

	S	S	S	S	S	S	D
KH32, KHR32, KH40, KHR40, KH63, KHR63, KH80, KHR80	25-30 .98-1.18	27-37 1.06-1.46	34-44 1.34-1.73	42-52 1.65-2.05	49-59 1.93-2.32	57-67 2.24-2.64	45,6 1.80

V840E

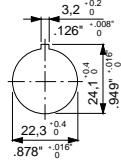
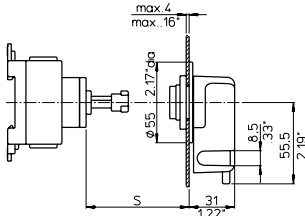

	S _{min.}	S _{max.}
KH16B-KHR25B	24,5 .96	110 4.33
KH32, KHR32, KH40, KHR40, KH63, KHR63, KH80, KHR80	20 .79	120 4.72

V840G/V840F

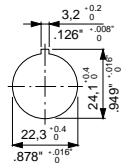
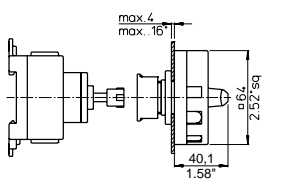

	S _{min.}	S _{max.}
KH16B-KHR25B	27,5 1.08	113 4.45
KH32, KHR32, KH40, KHR40, KH63, KHR63, KH80, KHR80	28 1.10	124 4.88

V845

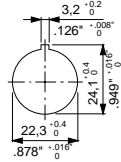
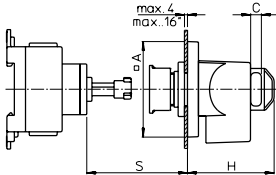

	A	C	H	S _{min.}	S _{max.}
KH16-KHR25	48 1.89	7,2 .28	52 2.05	29,5 1.16	119 4.69
KH16B-KHR25B	64 2.52	8,1 .32	58 2.28	27,5 1.08	113 4.45
KH32, KHR32, KH40, KHR40, KH63, KHR63, KH80, KHR80	64 2.52	8,1 .32	58 2.28	28 1.10	124 4.88

M600

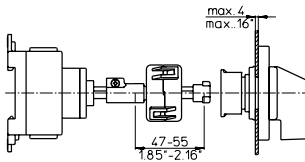

Door Clutches

M700/.

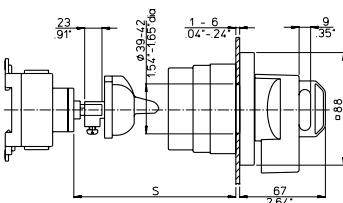

M701

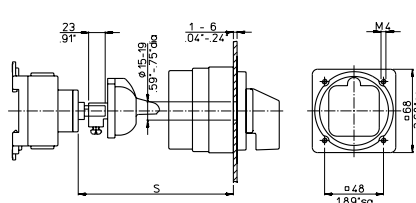

	S _{min.}	
	L100	M004D, M004
KH16B-KHR25B	61,5 2.42	-
KH32, KHR32, KH40, KHR40, KH63, KHR63, KH80, KHR80	61,5 2.42	68 2.68

Optional Extras

Door Clutches

M280D, M280D/.EF, M280E, M280E/.EF

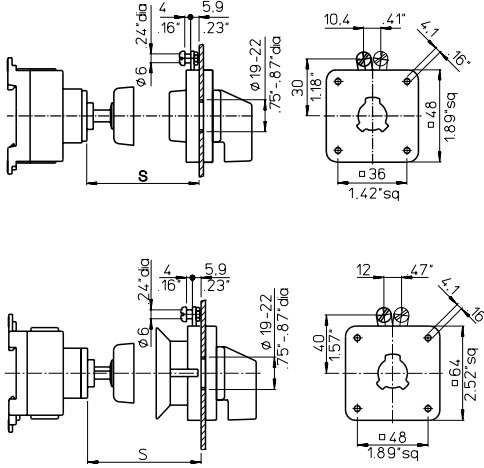

S = Standard length for switches of mounting VE

	S	S	S	S
KH16-KHR25	35-60	60-80	80-100	100-120
	1.38-2.36	2.36-3.15	3.15-3.94	3.94-4.72

	S	S	S	S
KH16B-KHR25B	37-64	64-84	84-104	104-124
	1.46-2.52	2.52-3.31	3.31-4.09	4.09-4.88
KH32, KHR32, KH40, KHR40, KH63, KHR63, KH80, KHR80	32-57	57-77	77-97	97-117
	1.26-2.24	2.24-3.03	3.03-3.82	3.82-4.61

Padlock Devices

V840D

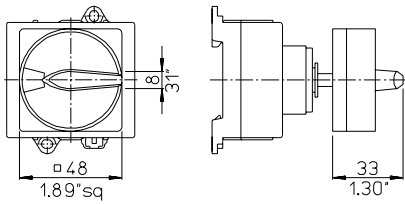

V840G, V840F/F

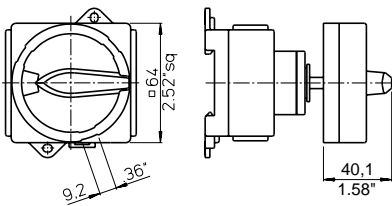

V840G/B, V840F/B

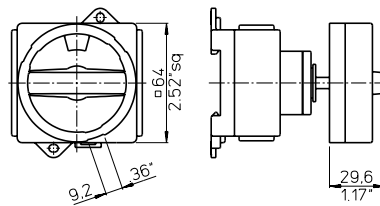

V840A

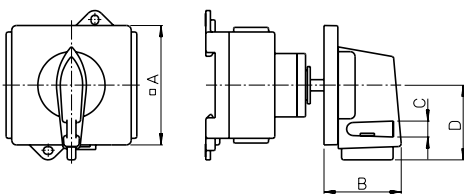

V845

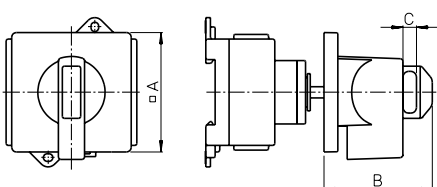

	A	B	C	D
KH16-KHR25	48	32,9	5	31,5
	1.89	1.30	.20	1.24
KH16B-KHR25B	64	41,6	7	40
	2.52	1.64	.28	1.57
KH32, KHR32, KH40, KHR40, KH63, KHR63, KH80, KHR80	64	41,6	7	40
	2.52	1.64	.28	1.57

	A	B	C
KH16-KHR25	48	51	7,2
	1.89	2.01	.28
KH16B-KHR25B	64	58	8,1
	2.52	2.28	.32
KH32, KHR32, KH40, KHR40, KH63, KHR63, KH80, KHR80	64	58	8,1
	2.52	2.28	.32

The Range of “Blue Line” Switchgear

Technical literature covering the following products is available on request.

	Catalog Number
Main Switches and Main Switches with Emergency Function 16 A-315 A Maintenance Switches 20 A-315 A Switch Disconnectors 20 A-315 A According to IEC 60947-3, EN 60947-3, VDE 0660 part 107, IEC 60204, EN 60204 and VDE 0113	500
CL Switches 10 A-20 A C, CA and CAD Switches 10 A-315 A and L Switches 350 A-2400 A C, CA and CAD switches are designed for universal application. They are recommended for instrument, isolator, double-throw and motor control. L switches are designed for load and off-load applications. They are used to switch resistive or low inductive loads.	100
Optional Extras and Enclosures The complete product line, a large number of optional extras is available, including door interlocks, push-pull devices, cylinder and padlock attachments, control and indicator devices, AC motor drives, as well as enclosures, both insulated and metal.	101
A and AD Switches 6 A-25 A A and AD switches have 4 contacts in each switching stage. These switches provide an extensive range of switch functions and require a minimum mounting depth. Up to 24 switching positions are possible, with availability of 48 contacts per 12 stage switch column.	110
CG, CH and CHR Switches 10 A-25 A Ultra compact CG, CH and CHR switches are ideally suited for control and instrumentation applications. Switch terminals are “finger-proof” and conveniently accessible for wiring and are delivered open. All CG4 switches offer specially designed gold plated contacts or H-bridges with “cross-wire” contact systems, which facilitates their use in electronic circuitry and chemically aggressive environments.	120
DH, DHR, DK and DKR Switches 6 A-16 A DH, DHR, DK and DKR switches incorporate unique corrosion resistant contacts that permit operation on system voltage as low as 1 V. They have fully enclosed and protected contacts which can be operated either by rotary and/or lateral handle movement. D switches are used in calibration and semiconductor circuits. They are also used for relay and contactor control.	130
X Switches 80 A-630 A X switches can be applied for load, tap and gang switching duties. They incorporate 6 contacts in each switching stage. Their compact design provides a minimum length dimension for mounting purposes.	140
KG Switches 20 A-315 A and KH and KHR Switches 16 A-80 A KG, KH and KHR switches are excellent circuit interruptors. They have high through fault and fault making capacities and are especially designed for use as isolators and safety switches for machine tools, distribution panels and switchboards. KG ON/OFF switches offer unusually high dimensioned air and creepage distances between terminals which are designed for time saving “straight-line” wiring. ON/OFF switches are available with up to 8 poles and double-throw switches are available with up to 4 poles.	150
Contactors 16 A-115 A and Motor Starters 1,1 kW-55 kW These include control relays, motor contactors, two and four pole output contactors, heating contactors, thermal overload relays.	200
Push Buttons and Pilot Lights, 22,5 mm Ø A complete range of state-of-the-art push buttons and pilot lights represent an ideal combination of functional security and economical efficiency in a modular design.	302

We reserve the right to make technical and dimensional changes without prior notice.

SALES AND SERVICE ORGANIZATION

Australia

Kraus & Naimer Pty. Ltd.
379 Liverpool Road, ASHFIELD, N.S.W. 2131
Tel: +61 2 9797-7333, Fax: 0092
salesaus@krausnaimer.com

Austria

Kraus & Naimer GmbH
Schumanngasse 35
1180 WIEN
Tel: +43 1 404 06-0, Fax: 404 06-190
aso@krausnaimer.com

Belgium, Luxembourg

Kraus & Naimer B.V.
Ikaros Business Park
Ikaroslaan 2
B-1930 ZAVENTHEM
Tel: +32 2 757-0141, Fax: 1640
sales.be@krausnaimer.com

Brazil

Central and South America
Kraus & Naimer Ind. Com. Ltda.
Rua Santa Monica, 1061
Parque Industrial San Jose
06715-865 Cotia - SP
Tel: +55 11 2198-1288, Fax: 1251
knbrasil@krausnaimer.com.br

Canada

Kraus & Naimer Ltd.
219 Connie Crescent, Unit: 13A
CONCORD, Ontario, L4K 1L4
Tel: +1 905 738-1666, Fax: 9327
salescan@krausnaimer.com

Cyprus

ELECTROMATIC CONSTRUCTIONS LTD.
72, Evagoras Pellikarides Str., CY-2235 LATSIA-Nicosia
P. O. Box 12630, CY-2251 LATSIA-Nicosia
Tel: +357 2 48 41 41, Fax: 48 57 47

Czech Republic

OBZOR, výrobní družstvo Zlín
Na Slanici 378
CZ-76413 ZLÍN
Tel: +420 57 7195-111/-153 (Techn. Supp.)
Fax: +420 57 7195-152/-138
ots@obzor.cz

Denmark

THIIM A/S
Transformervej 31
DK-2730 HERLEV
Tel: +45 4485 8000, Fax: 8005
thiim@thiim.com

Finland

Kraus & Naimer Oy
Kiitoradankuja 8
FIN-01530 VANTAA
Tel: +358 9 825-424-0, Fax: 424-10
myynti@krausnaimer.com

France

Kraus & Naimer s.a.s.
33, rue Bobillot
F-75013 PARIS
Tel: +33 1 58 40 80 80, Fax: 45 80 91 19
ventes@krausnaimer.com

Germany

Kraus & Naimer GmbH
Wikingerstraße 20-28, D-76189 KARLSRUHE
Postfach 10 01 24, D-76231 KARLSRUHE
Tel: +49 721 59 88-0, Fax: 59 28 28
sales.ger@krausnaimer.com

Great Britain

Kraus & Naimer Ltd.
115 London Road
NEWBURY/BERKSHIRE RG14 2AH
Tel: +44 1635 262626, Fax: 37807
sales-uk@krausnaimer.com

Greece

KALAMARAKIS-SAPOUNAS S. A.
Ionias & Neromilou Str., P. O. Box 46566
GR-13671 ACHARNES/ATHENS
Tel: +30 2 10 240-6000-6, Fax: 240-6007
kalamarakis.sapounas@ksa.gr

Hungary

GANZ, Schalter- u. Gerätefabrik
X. Kőbányal út 41/c, Postfach 87
H-1475 BUDAPEST
Tel: +36 1 261-5479, Fax: 4685
ganzkk@ganzkk.hu

Iceland

BRAEDURNIR ORMSSON EHF
Lágmúli 6-8, P. O. Box 8670
REYKJAVIK
Tel: +354 530-28 00, Fax: 28 10
skuli@ormsson.is

India

BLISS ELECTRICALS Pvt. Ltd.
SA42 A&B, 2nd Flr, Lake City Mall,
Kapurbavdi Junction,
THANE (W) - 400 607
Tel: +91-22-25368609
kane.shriram@blisselectricals.com

Republic of Ireland

Kraus & Naimer Ltd.
4235 Atlantic Avenue
Westpark Business Campus
Shannon, Co. Clare
Tel: +353 61 704700, Fax: 471084
sales-ie@krausnaimer.com

Italy

Kraus & Naimer s.r.l.
Via Terracini, 9
I-24047 TREVIGLIO (BG)
Tel: +39 0363-30 11 12, Fax: 30 21 13
SalesItaly@krausnaimer.com

Japan

Kraus & Naimer Ltd.
Yoshiwada Building 2F
1-11-6 Hamamatsucho
Minato-Ku, TOKYO 105-0013
Tel: +81 3 3436-6151, Fax: 6325
sales-jpn@krausnaimer.com

Mexico

JC Ingeniería y Control, SA de CV.
Ángel Gaviño 30.
C. Satélite, C. Medicos,
Naucalpan Edo. de Mexico, C.P. 53100
Tel. (+52 55) 55 62 75 77, Fax. 55 62 04 34
ventas@jcingeneriaycontrol.com

Middle East - UAE

Branch Office, Kraus & Naimer Pte. Ltd.
SAIF Zone, P. O. Box 121607,
Sharjah, UAE
Tel: +971 6 557 8886
Fax: +971 6 557 8088
uae@krausnaimer.com

Netherlands

Kraus & Naimer B.V.
Wegtersweg 38-40, Postbus 199
NL-7556 BR HENGEL0 (Ov.)
Tel: +31 74 291-9441, Fax: 8380
sales.nl@krausnaimer.com

New Zealand

Kraus & Naimer Ltd.
42 Miramar Avenue, WELLINGTON 6022
P. O. Box 15-009, WELLINGTON 6243
Tel: +64 4 380-9888, Fax: 9877
sales-nz@krausnaimer.com

Norway

Kraus & Naimer AS
Hjalmar Brantings vei 8, P. O. Box 21, Økern
N-0508 OSLO
Tel: +47 22 64 44 20, Fax: 65 39 49
ordre.no@krausnaimer.com

Poland

ASTAT sp. z o.o.
ul. Dąbrowskiego 461
PL-60451 POZNAN
Tel: +48 61 848-8871/72, Fax: 8276
info@astat.com.pl

Portugal

ELECTRICOL-DAMAS, FERREIRA & DAMASCENO, LDA.
Apartado 1063, S. Ant. Cavaleiros
P-2670 LOURES
Tel: +351 21 989-8939, Fax: 988-6464
electrical@electricol.pt

Singapore

Kraus & Naimer Pte. Ltd.
Blk 115A, Commonwealth Drive
#03-17/23
SINGAPORE 149 596
Tel: +65 6473-8166, Fax: 8643
sgp@krausnaimer.com

Slovenia

SCHRACK Technik d.o.o.
Pameče 175
SI-2380 Slovenj Gradec
Tel: +386 2 883 92 00, Fax: +386 2 884 34 71
m.abeln@schrack.si

Republic of South Africa

Kraus & Naimer Pty. Ltd.
7 Village Crescent, Linbro Village
Linbro Business Park, SANDTON 2065
P. O. Box 511, KELVIN 2054
Tel: +27 11 608-6060, Fax: 608-2874
salesZAF@krausnaimer.com

Spain

Kraus & Naimer B.V.
Tel: +34 662 696 014
sales.es@krausnaimer.com

Sweden

Kraus & Naimer AB
Dr. Widerströms Gata 11, FRUÅNGEN
Box 42097, S-126 14 STOCKHOLM
Tel: +46 8 97 00 80, Fax: 97 87 33
order.se@krausnaimer.com

Switzerland

AWAG Elektrotechnik AG
Sandbühlstraße 2, Postfach
CH-8604 VOLKETSCHWIL
Tel: +41 44 908 19 19, Fax: 19 99
info@awag.ch, www.awag.ch

Turkey

KARDEŞ ELEKTRİK SANAYİ VE TİCARET ANONİM ŞİRKETİ
Beşyol, Eski Londra Asfaltı-6
TR-34295 İSTANBUL-Sefaköy
Tel: +90 212 624-9204, Fax: 592-4810
info@unalkardes.com.tr

USA

Kraus & Naimer Inc.
760 New Brunswick Road
SOMERSET, NJ 08873
Tel: +1 732 560-1240, Fax: 8823
salesusa@krausnaimer.com



Kraus & Naimer

BLUE LINE switchgear



Contact us:

www.krausnaimer.com