

---

# BALDOR®

---

A MEMBER OF THE ABB GROUP



# COWERN PAPERS





A MEMBER OF THE ABB GROUP

---

Baldor Electric Company  
5711 R.S. Boreham Jr. Street  
Fort Smith, AR 72901  
Phone (479) 646-4711  
Fax (479) 648-5792  
[www.baldor.com](http://www.baldor.com)

Enclosed you will find a set of papers that I have written on motor related subjects. For the most part, these have been written in response to customer questions regarding motors.

I hope you find them useful and I would appreciate any comments or thoughts you might have for future improvements, corrections or topics.

If you should have questions on motors not covered by these papers, please give us a call and we will do our best to handle them for you.

Thank you for buying Baldor motors.

Sincerely,

A handwritten signature in black ink, appearing to read "Ed Cowern". The signature is fluid and cursive, written over a white background.

Edward Cowern, P.E.



**BALDOR • RELIANCE**  
"To be the best as determined by our customers"



# **ABOUT THE AUTHOR**

## **Edward H. Cowern, P.E.**

Ed Cowern was Baldor's District Manager in New England, U.S.A. from 1977 to 1999. Prior to joining Baldor he was employed by another motor company where he gained experience with diversified motors and related products.

He is a graduate of the University of Massachusetts where he obtained a BS degree in Electrical Engineering. He is also a registered Professional Engineer in the state of Connecticut, a member of the Institute of Electrical and Electronic Engineers (IEEE), and a member of the Engineering Society of Western Massachusetts.

Ed is an excellent and well-known technical writer, having been published many times in technical trade journals such as Machine Design, Design News, Power Transmission Design, Plant Engineering, Plant Services and Control Engineering. He has also been quoted in Fortune Magazine. In addition, he has authored many valuable technical papers for Baldor, used repeatedly by sales and marketing personnel throughout our company.

Ed lives in North Haven, Connecticut with his wife, Irene. He can be reached at [ehcowern@snet.net](mailto:ehcowern@snet.net).

# TABLE OF CONTENTS

## Motor Basics

Glossary of Frequently Occurring Motor Terms . . . . .	1
Types of Motors . . . . .	5
The Mystery of Motor Frame Size . . . . .	11
A Primer on Two Speed Motors . . . . .	15
Motor Temperature Ratings . . . . .	17
Metric Motors . . . . .	23
Locked Rotor Code Letters and Reduced Voltage Starting Methods . . . . .	27

## Applications

Understanding Torque . . . . .	31
Fans, Blowers, and Other Funny Loads. . . . .	41
RMS Horsepower Loading . . . . .	43

## Power & Energy

Factors That Determine Industrial Electric Bills. . . . .	47
Electric Motors and Power Systems . . . . .	53
Electric Motors and Voltage . . . . .	59
Unbalanced Currents. . . . .	63
Conserving with Premium Efficiency Motors . . . . .	65
Premium Efficiency Motors — (Questions and Answers)) . . . . .	75
Amps, Watts, Power Factor and Efficiency . . . . .	79
Approximate Load Data from Amperage Readings . . . . .	83
Power Factor Correction on Single Induction Motors. . . . .	85
Convenient Motor & Energy Formulas . . . . .	89
Horsepower Calculations for Speed Changes on Variable Torque Loads . . . . .	91

## Hazardous Location

How to Select Motors for Hazardous Locations . . . . .	93
Explosion Proof Motors in Division II Areas . . . . .	99

## Miscellaneous

DC Drive Fundamentals . . . . .	101
Handling 50 Hertz Requirements . . . . .	109
Operating Motors in Wet and Damp Environments . . . . .	113



# GLOSSARY OF FREQUENTLY OCCURRING MOTOR TERMS

## AMPS

### Full Load Amps

The amount of current the motor can be expected to draw under full load (torque) conditions is called Full Load Amps. it is also know as ***nameplate amps***.

### Locked Rotor Amps

Also known as ***starting inrush***, this is the amount of current the motor can be expected to draw under starting conditions when full voltage is applied.

### Service Factor Amps

This is the amount of current the motor will draw when it is subjected to a percentage of overload equal to the service factor on the nameplate of the motor. For example, many motors will have a service factor of 1.15, meaning that the motor can handle a 15% overload. The service factor amperage is the amount of current that the motor will draw under the service factor load condition.

## CODE LETTER

The code letter is an indication of the amount of inrush or locked rotor current that is required by a motor when it is started. (See “Locked Rotor Code Letters” for more details.)

## DESIGN

The design letter is an indication of the shape of the torque speed curve. Figure 1 shows the typical shape of the most commonly used three phase design letters.

They are A, B, C, and D. Design B is the standard industrial duty motor which has

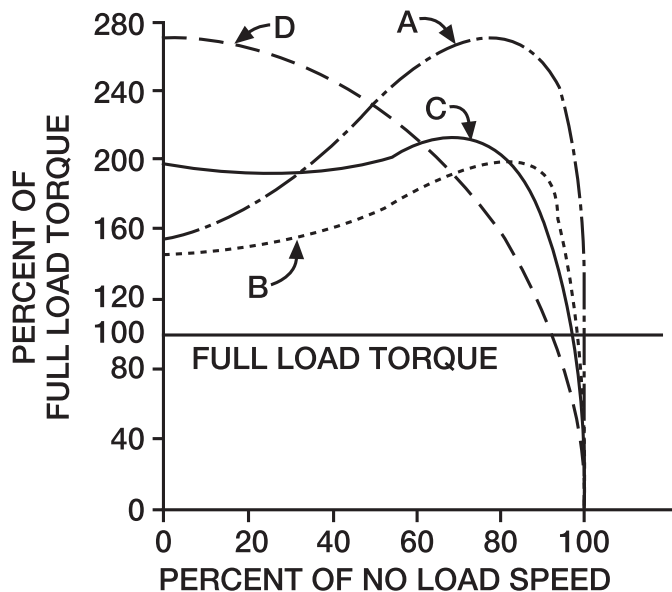

Figure 1

reasonable starting torque with moderate starting current and good overall performance for most industrial applications. Design C is used for hard to start loads and is specifically designed to have high starting torque. Design D is the so-called high slip motor which tends to have very high starting torque but has high slip RPM at full load torque. In some respects, this motor can be said to have a “spongy” characteristic when loads are changing. Design D motors are particularly suited for low speed, punch press applications and hoist and elevator applications. Generally, the efficiency of Design D motors at full load is rather poor and thus they are normally used on those applications where the torque characteristics are of primary importance. Design A motors are not commonly specified but specialized motors used on injection molding applications have characteristics similar to Design A. The most important characteristic of Design A is the high pullout torque.

## EFFICIENCY

Efficiency is the percentage of the input power that is actually converted to work output from the motor shaft. Efficiency is stamped on the nameplate of most domestically-produced electric motors.

## FRAME SIZE

Motors, like suits of clothes, shoes and hats, come in various sizes to match the requirements of the application. In general, the frame size gets larger with increasing horsepower or with decreasing speeds. In order to promote standardization in the motor industry, NEMA (National Electrical Manufacturers Association) prescribes standard frame sizes for certain dimensions of standard motors. For example, a motor with a frame size of 56, will always have a shaft height above the base of 3-1/2 inches. (See “The Mystery of Motor Frame Size” for more details.)

**FREQUENCY** This is the frequency for which the motor is designed. The most commonly occurring frequency in this country is 60 cycles but, on an international basis, other frequencies such as 40, and 50 cycles can be found.

**FULL LOAD SPEED** An indication of the approximate speed that the motor will run when it is putting out full rated output torque or horsepower is called **full load speed**.

**HIGH INERTIA LOAD** These are loads that have a relatively high flywheel effect. Large fans, blowers, punch presses, centrifuges, commercial washing machines, and other types of similar loads can be classified as high inertia loads.

**INSULATION CLASS** The insulation class is a measure of the resistance of the insulating components of a motor to degradation from heat. Four major classifications of insulation are used in motors. they are, in order of increasing thermal capabilities, A, B, F, and H. (See "Motor Temperature Rating" for more details.)

**LOAD TYPES** **Constant Horsepower**  
The term constant horsepower is used in certain types of loads where the torque requirement is reduced as the speed is increased and vice-versa. The constant horsepower load is usually associated with metal removal applications such as drill presses, lathes, milling machines, and other similar types of applications.

**Constant Torque**  
Constant torque is a term used to define a load characteristic where the amount of torque required to drive the machine is constant regardless of the speed at which it is driven. For example, the torque requirement of most conveyors is constant.

**Variable Torque**  
Variable torque is found in loads having characteristics requiring low torque at low speeds and increasing values of torque as the speed is increased. Typical examples of variable torque loads are centrifugal fans and centrifugal pumps.

**PHASE** Phase is the indication of the type of power supply for which the motor is designed. Two major categories exist; single phase and three phase. There are some very spotty areas where two phase power is available but this is very insignificant.

**POLES** This is the number of magnetic poles that appear within the motor when power is applied. Poles always come in sets of two (a north and a south). Thus, the number of poles within a motor is always an even number such as 2, 4, 6, 8, 10, etc. In an AC motor, the number of poles work in conjunction with the frequency to determine the synchronous speed of the motor. At 50 and 60 cycles, the common arrangements are:

<u>Poles</u>	<u>Synchronous Speed</u>	
	<u>60 Cycles</u>	<u>50 Cycles</u>
2	3600	3000
4	1800	1500
6	1200	1000
8	900	750
10	720	600

**POWER FACTOR** Per cent power factor is a measure of a particular motor's requirements for magnetizing amperage.



**SERVICE FACTOR**

The service factor is a multiplier that indicates the amount of overload a motor can be expected to handle. For example, a motor with a 1.0 service factor cannot be expected to handle more than its nameplate horsepower on a continuous basis. Similarly, a motor with a 1.15 service factor can be expected to safely handle intermittent loads amounting to 15% beyond its nameplate horsepower.

**SLIP**

Slip is used in two forms. One is the slip RPM which is the difference between the synchronous speed and the full load speed. When this slip RPM is expressed as a percentage of the synchronous speed, then it is called percent slip or just “slip”. Most standard motors run with a full load slip of 2% to 5%.

**SYNCHRONOUS SPEED**

This is the speed at which the magnetic field within the motor is rotating. It is also approximately the speed that the motor will run under no load conditions. For example, a 4 pole motor running on 60 cycles would have a magnetic field speed of 1800 RPM. The no load speed of that motor shaft would be very close to 1800, probably 1798 or 1799 RPM. The full load speed of the same motor might be 1745 RPM. The difference between the synchronous speed and the full load speed is called the slip RPM of the motor.

**TEMPERATURE**

**Ambient Temperature**

Ambient temperature is the maximum safe room temperature surrounding the motor if it is going to be operated continuously at full load. In most cases, the standardized ambient temperature rating is 40°C (104° F). This is a very warm room. Certain types of applications such as on board ships and boiler rooms, may require motors with a higher ambient temperature capability such as 50° C or 60° C.

**Temperature Rise**

Temperature rise is the amount of temperature change that can be expected within the winding of the motor from non-operating (cool condition) to its temperature at full load continuous operating condition. Temperature rise is normally expressed in degrees centigrade. (See “Motor Temperature Ratings” for more details)

**TIME RATING**

Most motors are rated for continuous duty which means that they can operate at full load torque continuously without overheating. Motors used on certain types of applications such as waste disposal, valve actuators, hoists, and other types of intermittent loads, will frequently be rated for short term duty such as 5 minutes, 15 minutes, 30 minutes, or 1 hour. Just like a human being, a motor can be asked to handle very strenuous work as long as it is not required on a continuous basis.

**TORQUE**

Torque is the twisting force exerted by the shaft of a motor. Torque is measured in pound inches, pound feet, and on small motors, in terms of ounce inches. (For more information see “Understanding Torque”.)

**Full Load Torque**

Full load torque is the rated continuous torque that the motor can support without overheating within its time rating.

**Peak Torque**

Many types of loads such as reciprocating compressors have cycling torques where the amount of torque required varies depending on the position of the machine. The actual maximum torque requirement at any point is called the peak torque requirement. Peak torques are involved in things such as punch presses and other types of loads where an oscillating torque requirement occurs.

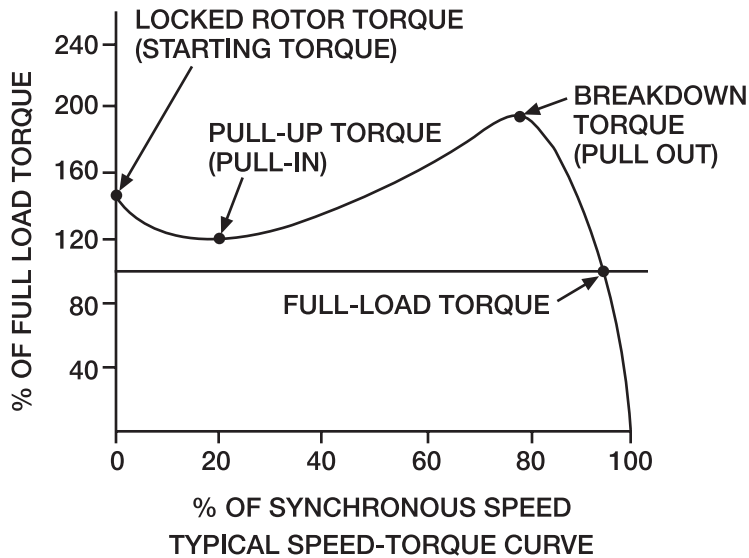

Figure 2

### Pull Out Torque

Also known as **breakdown torque**, this is the maximum amount of torque that is available from the motor shaft when the motor is operating at full voltage and is running at full speed. The load is then increased until the maximum point is reached. Refer to figure 2.

### Pull Up Torque

The lowest point on the torque speed curve for a motor that is accelerating a load up to full speed is called pull up torque. Some motor designs do not have a value of pull up torque because the lowest point may occur at the locked rotor point. In this case, pull up torque is the same as locked rotor torque.

### Starting Torque

The amount of torque the motor produces when it is energized at full voltage and with the shaft locked in place is called starting torque. This value is also frequently expressed as “locked rotor torque”. It is the amount of torque available when power is applied to break the load away and start accelerating it up to speed.

## VOLTAGE

This would be the voltage rating for which the motor is designed.

# TYPES OF MOTORS

*The most reliable piece of electrical equipment in service today is a transformer. The second most reliable is the 3-phase induction motor. Properly applied and maintained, 3-phase motors will last many years. One key element of motor longevity is proper cooling. Motors are generally classified by the method used to dissipate the internal heat.*

Several standard motor enclosures are available to handle the range of applications from “clean and dry” such as indoor air handlers, to the “wet or worse” as found on roofs and wet cooling towers.

**Open Drip-proof (ODP)** motors are good for clean and dry environments. As the name implies, drip-proof motors can handle some dripping water provided it falls from overhead or no more than 15 degrees off vertical. These motors usually have ventilating openings that face down. The end housings can frequently be rotated to maintain “drip-proof” integrity when the motor is mounted in a different orientation. These motors are cooled by a continuous flow of the surrounding air through the internal parts of the motor.

**Totally Enclosed Fan Cooled (TEFC)** motors are cooled by an external fan mounted on the end opposite the shaft. The fan blows ambient air across the outside surface of the motor to carry heat away. Air does not move through the inside of the motor, so TEFC motors are suited for dirty, dusty, and outdoor applications. There are many special types of TEFC motors including Corrosion Protected and Washdown styles. These motors have special features to handle difficult environments. TEFC motors generally have “weep holes” at their lowest points to prevent condensation from puddling inside the motor. As in open drip-proof motors, if the TEFC motor is mounted in a position other than horizontal, the end housings can generally be repositioned to keep the weep holes at the lowest point.

**Totally Enclosed Air Over (TEAO)** motors are applied in the air-stream on machines such as vane axial fans where the air moved by a direct connected fan passes over the motor and cools it. TEAO motors frequently have dual HP ratings

depending on the speed and temperature of the cooling air. Typical ratings for a motor might be: 10 HP with 750 feet per minute of 104°F air, 10 HP with 400 FPM of 70°F air, or 12.5 HP with 3000 FPM of 70°F air. TEAO motors are usually confined to Original Equipment Manufacturer (OEM) applications because the air temperature and flows need to be predetermined.

**Totally Enclosed Non-ventilated (TENV)** motors are generally confined to small sizes (usually under 5 HP) where the motor surface area is large enough to radiate and convect the heat to the outside air without an external fan or air flow. They have been popular in textile applications because lint cannot obstruct cooling.



**Hazardous Location Motors** are a special form of totally enclosed motor. They fall into different categories depending upon the application and environment, as defined in Article 500 of the National Electrical Code.

The two most common hazardous location motors are Class I, Explosion proof, and Class II, Dust Ignition Resistant. The term explosion proof is commonly but erroneously used to refer to all categories of hazardous location motors. Explosion proof applies only to Class I environments, which are those that involve potentially explosive liquids, vapors, and gases. Class II is termed Dust Ignition Resistant. These motors are used in environments that contain combustible dusts such as coal, grain, flour, etc.

## Single Phase Motors

Three phase motors start and run in a direction based on the “phase rotation” of the incoming power. Single phase motors are different. They require an auxiliary starting means. Once started in a direction, they continue to run in that

direction. Single phase motors are categorized by the method used to start the motor and establish the direction of rotation.

Category	Approximate HP Range	Relative Efficiency
Shaded pole	1/100 - 1/6 HP	Low
Split Phase	1/25 - 1/2 HP	Medium
Capacitor	1/25 - 15 HP	Medium to High

The three categories generally found in HVAC applications are:

**Shaded pole** is the simplest of all single phase starting methods. These motors are used only for small, simple applications such as bathroom exhaust fans. In the shaded pole motor, the motor field poles are notched and a copper shorting ring is installed around a small section of the poles as shown in *Figure A-1*.

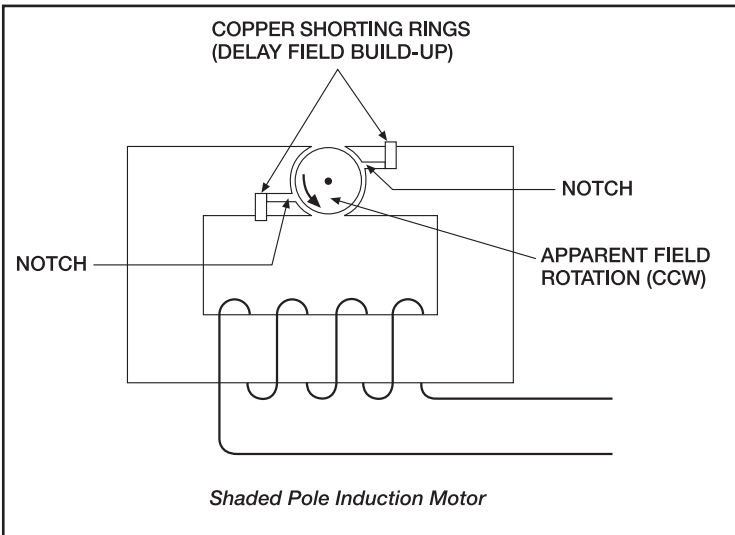

Figure A-1: Shaded pole is the simplest of all single phase starting methods.

The **altered pole** configuration delays the magnetic field build-up in the portion of the poles surrounded by the copper shorting rings. This arrangement makes the magnetic field around the rotor seem to rotate from the main pole toward the shaded pole. This appearance of field rotation starts the rotor moving. Once started, the motor accelerates to full speed.

The **split phase motor** has two separate windings in the stator (stationary portion of the motor). See *Figure A-2*. The winding shown in black is only for starting. It uses a smaller wire size and has

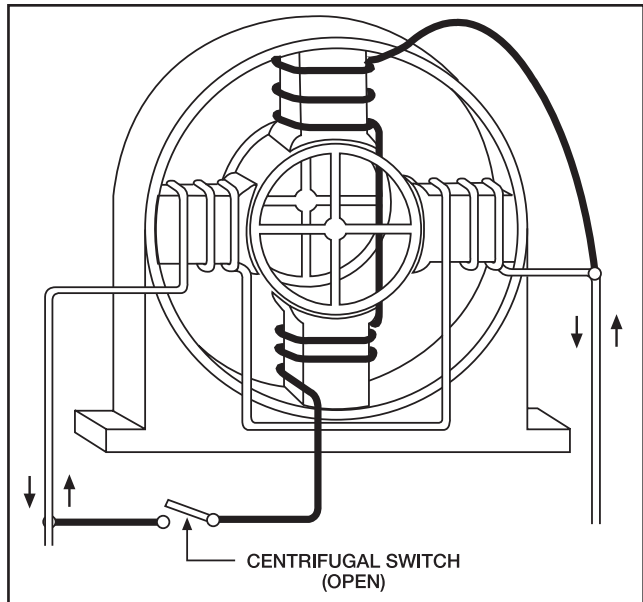

Figure A-2: The split-phase motor has two separate windings in the stator.

higher electrical resistance than the main winding. The difference in the start winding location and its altered electrical characteristics causes a delay in current flow between the two windings. This time delay coupled with the physical location of the starting winding causes the field around the rotor to move and start the motor. A centrifugal switch or other device disconnects the starting winding when the motor reaches approximately 75% of rated speed. The motor continues to run on normal induction motor principles.

Split phase motors are generally available from 1/25 to 1/2 HP. Their main advantage is low cost. Their disadvantages are low starting torque and high starting current. These disadvantages generally limit split phase motors to applications where the load needs only low starting torque and starts are infrequent.

Capacitor motors are the most popular single phase motors. They are used in many agricultural, commercial and industrial applications where 3-phase power is not available. Capacitor motors are available in sizes from subfractional to 15 HP.

Category	Usual HP Range
Capacitor start – induction run	1/8 - 3 HP
Single value capacitor <i>(also called permanent split capacitor or PSC)</i>	1/50 - 1 HP
Two-value capacitor <i>(also referred to as capacitor start capacitor run)</i>	2 - 15 HP

Capacitor motors fall into three categories:

**Capacitor Start Induction Run** motors form the largest group of general purpose single phase motors. The winding and centrifugal switch arrangement is similar to that in a split phase motor. However, a capacitor start motor has a capacitor in series with the starting winding. *Figure A-3* shows the capacitor start motor.

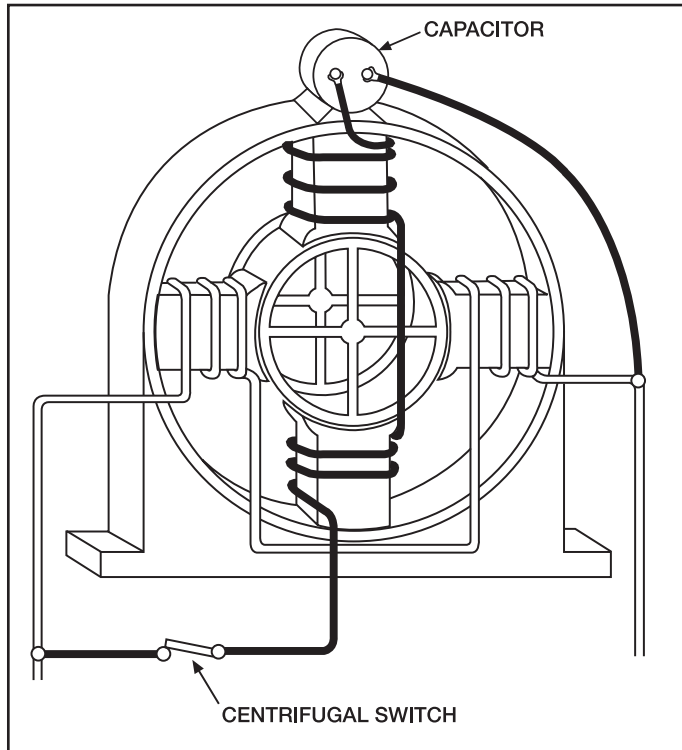

*Figure A-3: A capacitor start motor has a capacitor in series with the starter winding.*

The starting capacitor produces a time delay between the magnetization of the starting poles and the running poles, creating the appearance of a rotating field. The rotor starts moving in the same direction. As the rotor approaches running speed, the starting switch opens and the motor continues to run in the normal induction motor mode.

This moderately priced motor produces relatively high starting torque (225 to 400% of full load torque) with moderate inrush current. Capacitor start motors are ideal for hard to start loads such as refrigeration compressors. Due to its other desirable characteristics, it is also used in applications where high starting torque may not be required. The capacitor start motor can usually be recognized by the bulbous protrusion on the frame that houses the starting capacitor.

In some applications it is not practical to install a centrifugal switch within the motor, these motors have a relay operated by motor inrush current. The relay

switches the starting capacitor into the circuit during the starting period. When the motor approaches full speed the inrush current decreases and the relay opens to disconnect the starting capacitor.

**Single Value Capacitor Motors**, also called permanent Split Capacitor (PSC) motors utilize a capacitor connected in series with one of the two windings. This type of motor is generally used on small sizes (less than 1 HP). It is ideally suited for small fans, blowers, and pumps. Starting torque on this type of motor is generally 100%, or less, of full load torque.

**Two Value Capacitor Motors.** The two value capacitor motor is utilized in large horsepower (5-15 HP) single phase motors. *Figure A-4* shows this motor.

The running winding, shown in white, is energized directly from the line. A second winding, shown in black, serves as a combined starting and running winding. The black winding is energized through two parallel capacitors. Once the motor has started, a switch disconnects one of the capacitors letting the motor operate with the remaining capacitor in series with this winding of the motor.

The two value capacitor motor starts as a capacitor start motor but runs as a form of a two phase or PSC motor. Using this combination, it is possible to build large single phase motors having high starting torques and moderate starting currents at reasonable prices.

The two value capacitor motor frequently uses an oversize conduit box to house both the starting and running capacitors.

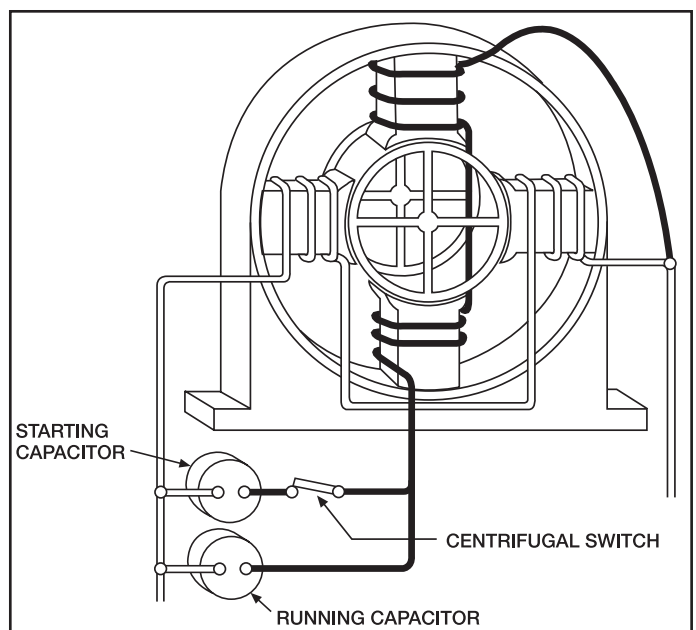

*Figure A-4: The two value capacitor motor is used in large horsepower single phase motors.*



**Motors Operating on Adjustable Frequency Drives (AFDs)** In the infancy of adjustable frequency drives (AFDs), a major selling point was that AFDs could adjust the speed of “standard” 3-phase induction motors. This claim was quite true when the adjustable frequency drives were “6-step” designs. The claim is still somewhat true, although Pulse Width Modulated (PWM) AFDs have somewhat changed the rules, PWM drives are electrically more punishing on motor windings, especially for 460 and 575 volt drives.

“Standard” motors can still be used on many AFDs, especially on HVAC fan, blower, and pump applications, as long as the motors are high quality, conservative designs that use Inverter Spike Resistant (ISR) magnet wire. On these variable torque loads a relatively small speed reduction results in a dramatic reduction in the torque required from the motor. For example, a 15% reduction in speed reduces the torque requirement by over 25%, so these motors are not stressed from a thermal point of view. Also, variable torque loads rarely need a wide speed range. Since the performance of pumps, fans, and blowers falls off dramatically as speed is reduced, speed reduction below 40% of base speed is rarely required.

The natural question is, “What is meant by a high quality, conservative designs?” Basically, this means that the motor must have phase insulation, should operate at a relatively low temperature rise (as in the case with most premium efficiency motors), and should use a high class of insulation (either F or H).

In addition, it is frequently desirable to have a winding thermostat in the motor that will detect any motor overheat conditions that may occur. Overheating could result from overload, high ambient temperature, or loss of ventilation.

“Inverter Duty Motors” being offered in the marketplace today incorporate “premium efficiency” designs along with oversized frames or external blowers to cool the motor regardless of its speed. These motors are primarily designed for constant torque loads where the affinity laws do not apply. “Inverter Duty Motors” usually have winding thermostats that shut the motor down through the AFD control circuit in case of elevated temperature inside the motor. Inverter Duty Motors also have high temperature insulating materials operated at lower temperatures. This reduces the stress on the insulation system. Although some of the design features of inverter duty motors are desirable for HVAC applications, HVAC applications usually do not require “inverter duty” motors.

Some cautions should be observed. Generally speaking, the power coming out of an AFD is somewhat rougher on the motor than power from a pure 60 cycle source. Thus it is not a good idea to operate motors on AFDs into their service factors.

In addition, when an old motor (one that has been in service for some time) is to be repowered from an adjustable frequency drive, it may be desirable to add a load reactor between the AFD and the motor. The reactor reduces the stress on the motor windings by smoothing out current variations, thereby prolonging motor life.

Reactors are similar to transformers with copper coils wound around a magnetic core. Load reactors increase in importance when the AFDs are going to run in the “quiet” mode. In this mode the very high carrier frequency can create standing waves that potentially double the voltage peaks applied to the motor. The higher voltage can stress the motor insulation enough to cause premature failure.

### **Service Factor**

Some motors carry a service factor other than 1.0. This means the motor can handle loads above the rated HP. A motor with a 1.15 service factor can handle a 15% overload, so a 10 HP motor with a 1.15 service factor can handle 11.5 HP of load. Standard open drip-proof motors have a 1.15 service factor. Standard TEFC motors have a 1.0 service factor, but most major motor manufacturers now provide TEFC motors with a 1.15 service factor.

The question often arises whether to use service factor in motor load calculations. In general, the best answer is that for good motor longevity, service factor should not be used for basic load calculations. By not loading the motor into the service factor, the motor can better withstand adverse conditions that occur. Adverse conditions include higher than normal ambient temperatures, low or high voltage, voltage imbalances, and occasional overload. These conditions are less likely to damage the motor or shorten its life if the motor is not loaded into its service factor in normal operation.

### **NEMA Locked Rotor Code**

The “NEMA Code Letter” is an additional piece of information on the motor nameplate. These letters indicate a range of inrush (starting – or “locked rotor”) currents that occur when a motor starts across the line with a standard magnetic or manual starter. Most

motors draw 5 to 7 times rated full load (nameplate) amps during the time it takes to go from standstill up to about 80% of full load speed. The length of time the inrush current lasts depends on the amount of inertia (flywheel effect) in the load. On centrifugal pumps with very low inertia, the inrush current lasts only a few seconds. On large, squirrel cage blowers the inrush current can last considerably longer.

The locked rotor code letter quantifies the value of the inrush current for a specific motor. The lower the code letter, the lower the inrush current. Higher code letters indicate higher inrush currents.

The table lists the NEMA locked rotor code letters and their parameters:

NEMA Code Letter	Locked Rotor KVA/HP	NEMA Code Letter	Locked Rotor KVA/HP
A	0 - 3.15	L	9.0 - 10.0
B	3.15 - 3.55	M	10.0 - 11.2
C	3.55 - 4.0	N	11.2 - 12.5
D	4.0 - 4.5	O	not used
E	4.5 - 5.0	P	12.5 - 14.0
F	5.0 - 5.6	Q	not used
G	5.6 - 6.3	R	14.0 - 16.0
H	6.3 - 7.1	S	16.0 - 18.0
I	not used	T	18.0 - 20.0
J	7.1 - 8.0	U	20.0 - 22.4
K	8.0 - 9.0	V	22.4 and up

\*Please refer to page 27 for formulas and more details. The code letters usually applied to common motors are:

	F	G	H	J	K	L
3 phase HP	15 up	10 - 7 <sup>1</sup> / <sub>2</sub>	5	3	2 - 1 <sup>1</sup> / <sub>2</sub>	1
1 phase HP		5	3	2 - 1 <sup>1</sup> / <sub>2</sub>	1, <sup>3</sup> / <sub>4</sub>	<sup>1</sup> / <sub>2</sub>

The proposed Design E motors, which will have very high efficiencies, will have higher inrush currents than the motors currently available. These motors will require special considerations when sizing circuit

breakers and starters for these motors when they become available. The 1998 National Electrical Code incorporated some special provisions for these proposed Design E motors.

### Insulation Classes

The electrical portions of every motor must be insulated from contact with other wires and with the magnetic portion of the motor. The insulation system consists of the varnish that jackets the magnet wire in the windings along with the slot liners that insulate the wire from the steel laminations. The insulation system also includes tapes, sleeving, tie strings, a final dipping varnish, and the leads that bring the electrical circuits out to the junction box.

Insulation systems are rated by their resistance to thermal degradation. The four basic insulation systems normally encountered are Class A, B, F, and H. Class A has a temperature rating of 105°C (221°F), and each step from A to B, B to F, and F to H involves a 25°C (45°F) jump. The insulation class in any motor must be able to withstand at least the maximum ambient temperature plus the temperature rise that occurs as a result of continuous full load operation. Selecting an insulation class higher than necessary to meet this minimum can help extend motor life or make a motor more tolerant of overloads, high ambient temperatures, and other problems that normally shorten motor life.

A widely used rule of thumb states that every 10°C (18°F) increase in operating temperature cuts insulation life in half. Conversely, a 10°C decrease doubles insulation life. Choosing a one step higher insulation class than required to meet the basic performance specifications of a motor provides 25°C of extra temperature capability. The rule of thumb predicts that this better insulation system increases the motor's thermal life expectancy by approximately 500%. For more information on motor temperature please see page 17.

### Motor Design Letters

The National Electrical Manufacturer's Association (NEMA) has defined four standard motor designs using the letters A, B, C and D. These letters refer to the shape of the motors' torque and inrush current vs. speed curves. Design B is the most popular motor. It has a relatively high starting torque with reasonable starting currents. The other designs are only used on

fairly specialized applications. Design A is frequently used on injection molding machines that require high pullout torques. Design C is a high starting torque motor that is usually confined to hard to start loads, such as conveyors that are going to operate under difficult conditions.

Design D is a so-called high slip motor and is normally limited to applications such as cranes, hoists, and low speed punch presses where high starting torque with low starting current is desirable. Design B motors do very well on most HVAC applications.



# THE MYSTERY OF MOTOR FRAME SIZE

## INTRODUCTION

Industrial electric motors have been available for nearly a century. In that time there have been a great many changes. One of the most obvious has been the ability to pack more horsepower in a smaller physical size. Another important achievement has been the standardization of motors by the National Electric Manufacturers Association (NEMA).

A key part of motor interchangeability has been the standardization of frame sizes. This means that the same horsepower, speed, and enclosure will normally have the same frame size from different motor manufacturers. Thus, a motor from one manufacturer can be replaced with a similar motor from another company provided they are both in standard frame sizes.

## THREE GENERATIONS

The standardization effort over the last forty years has resulted in one original grouping of frame sizes called "original". In 1952, new frame assignments were made. These were called "U frames". The current "T frames" were introduced in 1964. "T" frames are the current standard and most likely will continue to be for some time in the future.

Even though "T" frames were adopted in 1964, there are still a great many "U" frame motors in service that will have to be replaced in the future. Similarly there are also many of the original frame size motors (pre-1952) that will reach the end of their useful life and will have to be replaced. For this reason, it is desirable to have reference material available on frame sizes and some knowledge of changes that took place as a part of the so-called rerate programs.

## FRAME SIZE REFERENCE TABLES

Tables 1 and 2 show the standard frame size assignments for the three different eras of motors. As you will note, these tables are broken down for open drip proof (table 1) and totally enclosed (table 2). Also, you will find that for each horsepower rating and speed, there are three different frame sizes. The first is the original frame size, the middle one is the "U frame" size, and the third one is the "T frame". These are handy reference tables since they give general information for all three vintages of three phase motors in integral horsepower frame sizes.

One important item to remember is that the base mounting hole spacing ("E" and "F" dimensions) and shaft height ("D" dimension) for all frames having the same three digits regardless of vintage, will be the same.

## RERATING AND TEMPERATURES

The ability to rerate motor frames to get more horsepower in a frame has been brought about mainly by improvements made in insulating materials. As a result of this improved insulation, motors can be run much hotter. This allows more horsepower in a compact frame. For example, the original NEMA frame sizes ran at very low temperatures. The "U" frame motors were designed for use with Class A insulation, which has a rating of 105° C. The motor designs were such that the capability would be used at the hottest spot within the motor. "T" frame motor designs are based on utilizing Class B insulation with a temperature rating of 130° C. This increase in temperature capability made it possible to pack more horsepower into the same size frame. To accommodate the larger mechanical horsepower capability, shaft and bearing sizes had to be increased. Thus, you will find that the original 254 frame (5 HP at 1800 RPM) has a 1-1/8" shaft. The 254U frame (7-1/2 HP at 1800 RPM) has a 1-3/8" shaft, and the current 254T frame (15 HP at 1800 RPM) has a 1-5/8" shaft. Bearing diameters were also increased to accommodate the larger shaft sizes and heavier loads associated with the higher horsepowers.

## FRAME SIZE BASIS

On page 14 you will find a Baldor frame size chart that is a great reference on "T" frame, "U" frame and original frame motors. Most of the dimensions are standard dimensions that are common to all motor manufacturers. One exception to this is the "C" dimension (overall motor length) which will change from one manufacturer to another.

## **FRACTIONAL HORSEPOWER MOTORS**

The term “fractional horsepower” is used to cover those frame sizes having two digit designations as opposed to the three digit designations that are found in Tables 1 and 2. The frame sizes that are normally associated with industrial fractional horsepower motors are 42, 48, and 56. In this case, each frame size designates a particular shaft height, shaft diameter, and face or base mounting hole pattern. In these motors, specific frame assignments have not been made by horsepower and speed, so it is possible that a particular horsepower and speed combination might be found in three different frame sizes. In this case, for replacement it is essential that the frame size be known as well as the horsepower, speed and enclosure. The derivation of the two digit frame number is based on the shaft height in sixteenths of an inch. You can figure that a 48 frame motor will have a shaft height of 48 divided by 16 or 3 inches. Similarly, a 56 frame motor would have a shaft height of 3-1/2 inches. The largest of the current fractional horsepower frame sizes is a 56 frame which is available in horsepowers greater than those normally associated with fractionals. For example, 56 frame motors are built in horsepowers up to 3 HP and in some cases, 5 HP. For this reason, calling motors with 2 digit frame sizes “fractionals” is somewhat misleading.

## **INTEGRAL HORSEPOWER MOTORS**

The term Integral Horsepower Motors generally refers to those motors having three digit frame sizes such as 143T or larger. When dealing with these frame sizes one “rule of thumb” is handy. It is that the centerline shaft height (“D” dimension) above the bottom of the base is the first two digits of the frame size divided by four. For example, a 254T frame would have a shaft height of  $25 \div 4 = 6.25$  inches. Although the last digit does not directly relate to an “inch” dimension, larger numbers do indicate that the rear bolt holes are moved further away from the shaft end bolt holes (the “F” dimension becomes larger).

## **VARIATIONS**

In addition to the standard numbering system for frames, there are some variations that will appear. These are itemized below along with an explanation of what the various letters represent.

- C — Designates a “C” face (flange) mounted motor. This is the most popular type of face mounted motor and has a specific bolt pattern on the shaft end to allow mounting. The critical items on “C” face motors are the “bolt circle” (AJ dimension), register (also called rabbet) diameter (AK dimension) and the shaft size (U dimension). C flange motors always have threaded mounting holes in the face of the motor.
- D — The “D” flange has a special type of mounting flange installed on the shaft end. In the case of the “D” flange, the flange diameter is larger than the body of the motor and it has clearance holes suitable for mounting bolts to pass through from the back of the motor into threaded holes in the mating part. “D” flange motors are not as popular as “C” flange motors.
- H — Used on some 56 frame motors, “H” indicates that the base is suitable for mounting in either 56, 143T, or 145T mounting dimensions.
- J — This designation is used with 56 frame motors and indicates that the motor is made for “jet pump” service with a threaded stainless steel shaft and standard 56C face.
- JM — The letters “JM” designate a special pump shaft originally designed for a “mechanical seal”. This motor also has a C face.
- JP — Similar to the JM style of motor having a special shaft, the JP motor was originally designed for a “packing” type of seal. The motor also has a C face.
- S — The use of the letter “S” in a motor frame designates that the motor has a “short shaft”. Short shaft motors have shaft dimensions that are smaller than the shafts associated with the normal frame size. Short shaft motors are designed to be directly coupled to a load through a flexible coupling. They are not supposed to be used on applications where belts are used to drive the load.
- T — A “T” at the end of the frame size indicates that the motor is of the 1964 and later “T” frame vintage.
- U — A “U” at the end of the frame size indicates that the motor falls into the “U” frame size assignment (1952 to 1964) era.
- Y — When a “Y” appears as a part of the frame size it means that the motor has a special mounting configuration. It is impossible to tell exactly what the special configuration is but it does denote that there is a special non-standard mounting.
- Z — Indicates the existence of a special shaft which could be longer, larger, or have special features such as threads, holes, etc. “Z” indicates only that the shaft is special in some undefined way.

<b>TABLE 1 – OPEN DRIP-PROOF</b>												
<b>THREE PHASE FRAME SIZES – GENERAL PURPOSE</b>												
RPM NEMA Program HP	3600			1800			1200			900		
	Orig.	1952 Rerate	1964 Rerate	Orig.	1952 Rerate	1964 Rerate	Orig.	1952 Rerate	1964 Rerate	Orig.	1952 Rerate	1964 Rerate
1	—	—	—	203	182	143T	204	184	145T	225	213	182T
1.5	203	182	143T	204	184	145T	224	184	182T	254	213	184T
2	204	184	145T	224	184	145T	225	213	184T	254	215	213T
3	224	184	145T	225	213	182T	254	215	213T	284	254U	215T
5	225	213	182T	254	215	184T	284	254U	215T	324	256U	254T
7.5	254	215	184T	284	254U	213T	324	256U	254T	326	284U	256T
10	284	254U	213T	324	256U	215T	326	284U	256T	364	286U	284T
15	324	256U	215T	326	284U	254T	364	324U	284T	365	326U	286T
20	326	284U	254T	364	286U	256T	365	326U	286T	404	364U	324T
25	364S	286U	256T	364	324U	284T	404	364U	324T	405	365U	326T
30	364S	324US	284TS	365	326U	286T	405	365U	326T	444	404U	364T
40	365S	326US	286TS	404	364U	324T	444	404U	364T	445	405U	365T
50	404S	364US	324TS	405S	365US	326T	445	405U	365T	504	444U	404T
60	405S	365US	326TS	444S	404US	364T	504	444U	404T	505	445U	405T
75	444S	404US	364TS	445S	405US	365T	505	445U	405T	—	—	444T
100	445S	405US	365TS	504S	444US	404T	—	—	444T	—	—	445T
125	504S	444US	404TS	505S	445US	405T	—	—	445T	—	—	—
150	505S	445US	405TS	—	—	444T	—	—	—	—	—	—
200	—	—	444TS	—	—	445T	—	—	—	—	—	—
250	—	—	445TS	—	—	—	—	—	—	—	—	—

<b>TABLE 2 – TOTALLY ENCLOSED FAN COOLED</b>												
<b>THREE PHASE FRAME SIZES – GENERAL PURPOSE</b>												
RPM NEMA Program HP	3600			1800			1200			900		
	Orig.	1952 Rerate	1964 Rerate	Orig.	1952 Rerate	1964 Rerate	Orig.	1952 Rerate	1964 Rerate	Orig.	1952 Rerate	1964 Rerate
1	—	—	—	203	182	143T	204	184	145T	225	213	182T
1.5	203	182	143T	204	184	145T	224	184	182T	254	213	184T
2	204	184	145T	224	184	145T	225	213	184T	254	215	213T
3	224	184	182T	225	213	182T	254	215	213T	284	254U	215T
5	225	213	184T	254	215	184T	284	254U	215T	324	256U	254T
7.5	254	215	213T	284	254U	213T	324	256U	254T	326	284U	256T
10	284	254U	215T	324	256U	215T	326	284U	256T	364	286U	284T
15	324	256U	254T	326	284U	254T	364	324U	284T	365	326U	286T
20	326	286U	256T	364	286U	256T	365	326U	286T	404	364U	324T
25	365S	324U	284TS	365	324U	284T	404	364U	324T	405	365U	326T
30	404S	326US	286TS	404	326U	286T	405	365U	326T	444	404U	364T
40	405S	364US	324TS	405	364U	324T	444	404U	364T	445	405U	365T
50	444S	365US	326TS	444S	365US	326T	445	405U	365T	504	444U	404T
60	445S	405US	364TS	445S	405US	364T	504	444U	404T	505	445U	405T
75	504S	444US	365TS	504S	444US	365T	505	445U	405T	—	—	444T
100	505S	445US	405TS	505S	445US	405T	—	—	444T	—	—	445T
125	—	—	444TS	—	—	444T	—	—	445T	—	—	—
150	—	—	445TS	—	—	445T	—	—	—	—	—	—



# A PRIMER ON TWO SPEED MOTORS

There seems to be a lot of mystery involved in two speed motors but they are really quite simple. They can first be divided into two different winding types:

## TWO SPEED, TWO WINDING

The two winding motor is made in such a manner that it is really two motors wound into one stator. One winding, when energized, gives one of the speeds. When the second winding is energized, the motor takes on the speed that is determined by the second winding. The two speed, two winding motor can be used to get virtually any combination of normal motor speeds and the two different speeds need not be related to each other by a 2:1 speed factor. Thus, a two speed motor requiring 1750 RPM and 1140 RPM would, of necessity, have to be a two winding motor.

## TWO SPEED, ONE WINDING

The second type of motor is the two speed, single winding motor. In this type of motor, a 2:1 relationship between the low and high speed must exist. Two speed, single winding motors are of the design that is called consequent pole. These motors are wound for one speed but when the winding is reconnected, the number of magnetic poles within the stator is doubled and the motor speed is reduced to one-half of the original speed. The two speed, one winding motor is, by nature, more economical to manufacture than the two speed, two winding motor. This is because the same winding is used for both speeds and the slots in which the conductors are placed within the motor do not have to be nearly as large as they would have to be to accommodate two separate windings that work independently. Thus, the frame size on the two speed, single winding motor can usually be smaller than on an equivalent two winding motor.

## LOAD CLASSIFICATION

A second item that generates a good deal of confusion in selecting two speed motors is the load classification for which these motors are to be used. In this case, the type of load to be driven must be defined and the motor is selected to match the load requirement.

The three types that are available are: *Constant Torque*, *Variable Torque*, and *Constant Horsepower*.

For more details on load types please refer to "Understanding Torque" in this booklet.

## CONSTANT TORQUE

Constant torque loads are those types of loads where the torque requirement is independent of speed. This type of load is the normally occurring load on such things as conveyors, positive displacement pumps, extruders, hydraulic pumps, packaging machinery, and other similar types of loads.

## VARIABLE TORQUE

A second load type that is very different from Constant Torque is the kind of load presented to a motor by centrifugal pumps and blowers. In this case, the load torque requirement changes from a low value at low speed to a very high value at high speed. On a typical variable torque load, doubling the speed will increase the torque requirement by 4 times and the horsepower requirement by 8 times. Thus, on this type load, brute force must be supplied at the high speed and much reduced levels of horsepower and torque are required at the low speed. A typical two speed, variable torque motor might have a rating of 1 HP at 1725 and .25 HP at 850 RPM.

The characteristics of many pumps, fans, and blowers are such that a speed reduction to one-half results in an output at the low speed which may be unacceptable. Thus, many two speed, variable torque motors are made with a speed combination of 1725/1140 RPM. This combination gives an output from the fan or pump of roughly one-half when the low speed is utilized.

## **CONSTANT HORSEPOWER**

The final type of two speed motor that is utilized is the two speed, constant horsepower motor. In this case, the motor is designed so that the horsepower stays constant when the speed is reduced to the low value. In order to do this, it is necessary for the motor's torque to double when it is operating in the low speed mode. The normal application for this type of motor is on metal working processes such as drill presses, lathes, milling machines, and other similar metal removing machines.

The requirement for constant horsepower can perhaps be best visualized when you consider the requirements of a simple machine like a drill press. In this case, when drilling a large hole with a large drill, the speed is low but the torque requirement is very high. Compare that to the opposite extreme of drilling a small hole when the drill speed must be high but the torque requirement is low. Thus, there is a requirement for torque to be high when speed is low and torque to be low when speed is high. This is the Constant Horsepower situation.

The Constant Horsepower motor is the most expensive two speed motor. Three phase, two speed motors are quite readily available in constant torque and variable torque. Two speed, constant horsepower motors are usually only available on a special order basis.

## **TWO SPEED, SINGLE PHASE MOTORS**

Two speed, single phase motors for constant torque requirements are more difficult to supply since there is a problem of providing a starting switch that will operate at the proper time for both speeds. Thus, the normal two speed, single phase motor is offered as a variable torque motor in a permanent split capacitor configuration. The permanent split capacitor motor has very low starting torque but is suitable for use on small centrifugal pumps and fans.

## **SUMMARY**

The use of two speed motors in the future will grow quite rapidly as industrial motor users begin to realize the desirability of using this type of motor on exhaust fans and circulating pumps so that the air flow and water flow can be optimized to suit the conditions that exist in a plant or a process. Very dramatic savings in energy can be achieved by utilizing the two speed approach.



# MOTOR TEMPERATURE RATINGS

A frequently misunderstood subject related to electric motors is insulation class and temperature ratings. This paper tries to describe, in basic terms, the temperature relationships that are meaningful in standard AC induction motors. Some of the same information can be applied to DC motors but DC motors are more specialized and some of the ratings are slightly different.

Perhaps the best way to start is to define the commonly used terms.

## DEFINITIONS

### AMBIENT TEMPERATURE

Ambient temperature is the temperature of the air surrounding the motor or the room temperature in the vicinity of the motor. This is the “threshold point” or temperature that the entire motor would assume when it is shut off and completely cool.

### TEMPERATURE RISE

Temperature rise is the change in temperature of the critical electrical parts within a motor when it is being operated at full load. For example: if a motor is located in a room with a temperature of 78° F, and then is started and operated continuously at full load, the winding temperature would rise from 78° F to a higher temperature. The difference between its starting temperature and the final elevated temperature, is the motor’s temperature rise.

### HOT SPOT ALLOWANCE

Since the most common method of measuring “temperature rise” of a motor involves taking the difference between the cold and hot ohmic resistance of the motor winding\*, this test gives the average temperature change of the entire winding including the motor leads and end turns as well as wire placed deep inside the stator slots. Since some of these spots are bound to be hotter than others, an allowance factor is made to “fudge” the average temperature to give a reflection of what the temperature might be at the hottest spot. This allowance factor is called the “hot spot allowance”.

\*The formula for determining temperature rise by resistance is given on page 21.

### INSULATION CLASS

Insulations have been standardized and graded by their resistance to thermal aging and failure. Four insulation classes are in common use. For simplicity, they have been designated by the letters A, B, F, and H. The temperature capabilities of these classes are separated from each other by 25° C increments. The temperature capabilities of each insulation class is defined as being the maximum temperature at which the insulation can be operated to yield an average life of 20,000 hours. The rating for 20,000 hours of average insulation life is as shown below.

<u>Insulation Class</u>	<u>Temperature Rating</u>
A	105° C
B	130° C
F	155° C
H	180° C

### INSULATION SYSTEM

There are a number of insulating components used in the process of building motors. The obvious ones are the enamel coating on the magnet wire and the insulation on the leads that come to the conduit box. Some less obvious components of the “system” are the sleeving that is used over joints where leads connect to the magnet wire, and the lacing string that is used to bind the end turns of the motor. Other components are the slot liners that are used in the stator laminations to protect the wire from chafing. Also, top sticks are used to hold the wire down in place inside the

stator slots. Another important component of the system is the varnish in which the completed assembly is dipped prior to being baked. The dipping varnish serves the purpose of sealing nicks or scratches that may occur during the winding process. The varnish also binds the entire winding together into a solid mass so that it does not vibrate and chafe when subjected to the high magnetic forces that exist in the motor.

Much like a chain that is only as strong as its weakest link, the classification of an insulation system is based on the temperature rating of the lowest rated component used in the system. For example, if one Class B component is used along with F and H components, the entire system must be called Class B.

## **PUTTING IT ALL TOGETHER**

Now that the basic terms have been identified, we can move on to understand the total picture and how the factors of temperature go together in the motor rating.

The basic ambient temperature rating point of nearly all electric motors is 40° C. This means that a motor, rated for 40° C ambient, is suitable for installation in applications where the normal surrounding air temperature does not exceed 40° C. This is approximately 104° F. A very warm room. This is the starting point.

When the motor is operated at full load, it has a certain amount of temperature rise. The amount of temperature rise is always additive to the ambient temperature. For example, U frame motors were designed for Class A insulation and a maximum temperature rise by resistance of 55° C. When operated in a 40° C ambient temperature, this would give a total average winding temperature of 40° (ambient) + 55° (rise) or 95° C. The ten degree difference between 95° C and the 105° C rating of Class A insulation is used to handle the “hot spot allowance”. Now, if you use the same motor design but change the system to Class B, there is an extra 25° C of thermal capability available. This extra thermal capability can be used to handle:

- a – higher than normal ambient temperatures,
- b – higher than normal temperature rise brought on by overloads, or
- c – the extra capability can be used to extend motor life and make it more tolerant of overheating factors caused by high or low voltages, voltage imbalance, blocked ventilation, high inertia loads, frequent starts, and any other factors that can produce above normal operating temperatures.

For example: if a motor with Class A “design” (55° C) temperature rise is built with Class B insulation, then it could be expected to give a normal insulation life even when subjected to ambient temperatures of 65° C.

Most “T” frame motors are designed for use with Class B insulation. In a “T” frame motor with Class B insulation, the extra 25° of thermal capacity (Class B compared to Class A), is utilized to accommodate the higher temperature rise associated with the physically smaller “T” frame motors.

For example: a standard T frame, open drip proof motor might have the following rating: 40° C ambient, 80° C temperature rise, and a 10° hot spot allowance. When these three components are added together, you will find that the total temperature capability of Class B insulation (130° C) is used up.

## **CHANGING INSULATION CLASSES**

By taking a Class B, totally enclosed fan cooled, T frame motor, and building it with Class F insulation, it is usually possible to increase the service factor from 1.0 to 1.15. As mentioned previously, this same change of one insulation class can be used to handle a higher ambient temperature or to increase the life expectancy of the motor. The same change could also make the motor more suitable for operation in high elevations where thinner air has a less cooling effect.

## **ACTUAL INSULATING PRACTICE**

Over the years, great improvements have been made in insulating materials. With these improvements have come cost reductions. As a result of these changes, most motor manufacturers use a mixture of



materials in their motors, many of which have higher than required temperature ratings. For example, Baldor does not use Class A materials. This means that even though many fractional horsepower motors are designed for Class A temperature rise, the real insulation is Class B or better. Similarly, many motors designed for Class B temperature rise actually have insulation systems utilizing Class F and H materials. This extra margin gives the motor a “life bonus”. At the present time, Baldor has standardized on ISR (Inverter Spike Resistant) magnet wire in all three phase motors 1 HP and larger. This wire has a Class H temperature rating and excellent resistance to high voltage spikes.

As a rule of thumb, insulation life will be doubled for each 10 degrees of unused insulation temperature capability. For example: if a motor is designed to have a total temperature of 110° C (including ambient, rise, and hot spot allowance), and is built with a Class B (130° C) system, an unused capacity of 20° C would exist. This extra margin would raise the expected motor insulation life from 20,000 hours to 80,000 hours. Similarly, if a motor is not loaded to full capacity, its temperature rise will be lower. This automatically makes the total temperature lower and extends motor life. Also, if the motor is operated in a lower than 40° C ambient temperature, motor life will be extended.

The same ten degree rule also applies to motors operating at above rated temperature. In this case, insulation life is “halved” for each 10° C of overtemperature.

### **MOTOR SURFACE TEMPERATURES**

Motor surface temperature is frequently of concern. The motor surface temperature will never exceed the internal temperature of the motor. However, depending upon the design and cooling arrangements in the motor, motor surface temperature in modern motors can be high enough to be very uncomfortable to the touch. Surface temperatures of 75° to 95° C can be found on T frame motor designs. These temperatures do not necessarily indicate overload or impending motor failure.

### **OTHER FACTORS**

Insulation life is affected by many factors aside from temperature. Moisture, chemicals, oil, vibration, fungus growth, abrasive particles, and mechanical abrasion created by frequent starts, all work to shorten insulation life. On some applications if the operating environment and motor load conditions can be properly defined, suitable means of winding protection can be provided to obtain reasonable motor life in spite of external disturbing factors.

### **OLD AND CURRENT STANDARDS**

U frame 184 through 445U frames, were designed based on using Class A insulation. Temperature rise was not precisely defined by the resistance method. Temperature rise by thermometer for Class A, open drip proof motors was 40° C. This was generally thought to be equivalent to approximately 50° C by resistance. U frame motors were the industry standard from 1954 to 1965 and are still preferred in some industries and plants. T frame, 143T through 449T motors are generally designed based on using Class B insulation with temperature rises by resistance of approximately 80° C. Production of T frame motors started in the mid-sixties and they continue to be the industry standard at this time.

### **SUMMARY**

A key ingredient in motor life is the insulation system used in the motor. Aside from vibration, moisture, chemicals, and other non-temperature related life-shortening items, the key to insulation and motor life is the maximum temperature that the insulation system experiences and the temperature capabilities of the system components.

Table 1 shows the temperature ratings, temperature rise allowances and hot spot allowances for various enclosures and service factors of standard motors.

Table 2 shows a listing of temperature related life-shortening factors along with symptoms and cures. You may find this table useful.

**TABLE 1**

Insulation System Class	A	B	F	H
Temperature Rating in Degrees Centigrade	105°	130°	155°	180°
Temperature Rise Allowance by Resistance (Based on 40° C Ambient Temperature)				
All Motors with 1.15 Service Factor (Hot Spot Allowance)	70 *	90 *	115 *	—
Totally Enclosed Fan Cooled Motors (Hot Spot Allowance)	60 (5)	80 (10)	105 (10)	125 (15)
Totally Enclosed Non-Ventilated Motors (Hot Spot Allowance)	65 (0)	85 (5)	110 (5)	135 (5)
Motors other than those listed above (Hot Spot Allowance)	60 (5)	80 (10)	105 (10)	125 (15)

\* When operating at service factor loading the hot spot temperatures can actually exceed the insulation rating resulting in shortened motor life.

**TABLE 2****Temperature Related Life-Shortening Factors**

PROBLEMS	SYMPTOMS	CURES
Low Voltage	Overload Tripping High current Short motor life	Correct power supply or match motor to actual power supply voltage rating.
High Voltage	Overload tripping High Current Short Motor Life	Correct power supply or match motor to actual power supply voltage rating
Unbalanced Voltage	Unbalanced phase currents Overload tripping	Determine why voltages are unbalanced and correct.
Overload	Overload tripping High current Short motor life	Determine reason for overload. Increase motor size or decrease load speed.
High Ambient Temperatures	Short motor life	* Rewind motor to higher class of insulation. Oversize motor to reduce temperature rise. Ventilate area to reduce ambient temperature.
Blocked Ventilation	Short motor life Runs hot Amperage o.k.	Clean lint and debris from air passageways or use proper motor enclosure for application.
Frequent Starts	Short motor life	** Use a reduced voltage starting method. Upgrade class of insulation.
High Inertia Loads	Short motor life Overload tripping during starting	Oversize motor frame Use higher class of insulation. ** Use a reduced voltage starting method.

\* Bearing lubrication must also be matched to high operating temperature.

\*\* Reduced voltage starting method and motor characteristics must be matched to the load requirement.

## APPENDIX

### Temperature Rise by Resistance Method

$$\text{Degrees C Rise} = \frac{R_h - R_c}{R_c} (234.5 + T)$$

Where  $R_c$  = Cold Winding Resistance in Ohms

$R_h$  = Hot Winding Resistance in Ohms

$T$  = Cold (ambient) Temperature in Degrees Centigrade

Note: This formula assumes that the ambient temperature does not change during the test.

Example: A small motor has a cold temperature resistance of 3.2 ohms at 25° C (77° F) ambient temperature. After operating at full load for several hours, the resistance measures 4.1 ohms and the ambient has increased to 28° C.

Calculate the temperature rise:

$$\text{Apparent rise} = \frac{4.1 - 3.2}{3.2} (234.5 + 25) = 73^\circ \text{ C}$$

Correcting for 3° C increase in ambient:

$$\text{Actual rise} = 73^\circ - 3^\circ = 70^\circ \text{ C}$$

### Centigrade Fahrenheit Conversions Actual Temperatures

To change Fahrenheit to Centigrade:

$$C^\circ = (F^\circ - 32) \frac{5}{9}$$

To change Centigrade to Fahrenheit:

$$F^\circ = (C^\circ \times \frac{9}{5}) + 32$$

### Rise Values Only

Degrees "C" Rise = °F (Rise) x .56

Degrees "F" Rise = °C (Rise) x 1.8



# METRIC MOTORS

The influx of foreign equipment have put great numbers of metric motors in plants. As a result of this and the age of these motors, we are seeing inquiries for replacement motors that will match the IEC (International Electrical Commission) standards.

To help identify these motors and make suitable replacements, the following information could be useful.

## RATING SYSTEM

One of the first things is that ratings are given in kilowatts (KW) rather than horsepower. The first thing to do is to convert from kilowatts to horsepower. It is important to note that even though KW is an electrical term, in this case it is associated with mechanical output (just as horsepower is in this country). A simple factor will make the conversion. Multiply the KW rating of the motor by 1.34 to get the horsepower of the motor. For example, a 2 KW motor would be equal to approximately 2.7 HP and the closest NEMA equivalent would be 3 HP.

The next item of concern would be the speed of the motor. Generally, somewhere on the nameplate of the foreign motor, you find the speed listed in RPM. The convention in Europe seems to be to show the no load speed of the motor and occasionally, the 50 cycle speed may be shown rather than the 60 cycle speed. The following table shows a crossover from the 50 cycle speeds to the equivalent 60 cycle speeds. In some cases, both the 50 and 60 cycle speeds are shown generally separated with a slash, for example, 1500/1800 RPM. this would be a 4 pole motor that U. S. manufacturers would show nameplated with its full load speed. In this case it might be 1725 to 1760 RPM depending on the size of the motor.

	FREQUENCY			
	50 HZ SPEEDS (RPM)		60 HZ SPEEDS (RPM)	
POLES	SYNCHRONOUS	FULL LOAD (Typical)	SYNCHRONOUS	FULL LOAD (Typical)
2	3000	2850	3600	3450
4	1500	1425	1800	1725
6	1000	950	1200	1150
8	750	700	900	850

## EFFICIENCY

IEC 60034-30 specifies the efficiency levels for metric 50Hz motors. The equivalent to our EPC level of energy efficient motors (NEMA MG 1, table 12-11) is IE2; and premium efficient motors (NEMA MG 1, table 12-12) are IE3. Baldor manufactures metric motors to both levels. A new IEC 60034-2-1 test method now measures all losses and is equivalent to IEEE 112b and CSA 390.

## FAILURE REPLACEMENT

When an IEC (metric) motor fails in service the most practical way to proceed is to attempt to get an exact metric framed replacement motor. Baldor and other manufacturers offer a limited selection of the most popular ratings for direct replacement.

When direct replacements are not available, the following information should be helpful in adapting NEMA frame motors to the metric application.

## **FRAME SIZE**

European frame sizes are handled in a different way from U. S. frame sizes. They are based on the shaft height (equivalent to our “D” dimension) in millimeters. For example, a 112 frame would have a 112 millimeters shaft height. Convert this to inches by dividing 112 by 25.4 to get an equivalent domestic shaft height. In this case, the shaft height of a 112 frame would be slightly over 4.4 inches and the closest NEMA frame motor would be a 180 series frame (182, 184, 182T or 184T) with a shaft height of 4.5 inches. This is true for IEC base mounted motors. In the case of this motor, it would be necessary to make adjustments on the machine that would allow for either using the 180 series frame domestic motor and aligning the shaft height difference or by selecting a 145T or 56 frame motor (3.5" shaft height) and shimming up to get the proper alignment. The bolt pattern on the bases of IEC motors are given as metric dimensions and it is impossible to get complete interchangeability with NEMA frame sizes. However, it is usually possible on foot mounted motors to adapt to domestic frame sizes by drilling new holes or making other accommodation to accept the different footprint of the NEMA frame motor. IEC frame sizes for rigid base motors and the associated metric dimensions are shown on page 25. (Dimensions are in Millimeters — Divide by 25.4 to get inch equivalents.)

## **FLANGE MOUNTED MOTORS**

Flange mounted motors become a real nemesis for conversion. There are two popular face mounting configurations used on the IEC motors. The most popular is the “B5” configuration which is closest to NEMA “D” flange motors. the important thing to note is that with the B5 flange, the clearance holes are in the flange and the threaded holes are in the mating part, such as the pump, gear reducer or machine. The other popular IEC flange is the B14 flange. In this case, the threaded holes are in the face of the motor much the same as the NEMA “C” face motors.

IEC flange mounted motors all have metric rather than inch shaft diameters and where threaded holes are involved, they are metric rather than “inch” threads. To replace metric flange mounted motors, an exact flange mounting equivalent would be necessary unless someone is resourceful enough to make adapter flanges that would convert NEMA “C” face motors to the metric dimensions required. Since this usually is not the case, metric flange mounted motors have to be replaced with metric motors. Page 26 shows typical metric dimensions for B5 and B14 metric motors. Note that dimensions are given in Millimeters.

Baldor is now offering selections of metric, three phase, motors through 200kW. We also stock some permanent magnet DC motors that can be used as replacement units. On a custom basis when reasonable quantities are involved we can build many different metric equivalent motors.

## **SUMMARY**

This information should be useful in your day-to-day dealings in metric replacements.

## TYPICAL METRIC FOOT MOUNTED DIMENSIONS

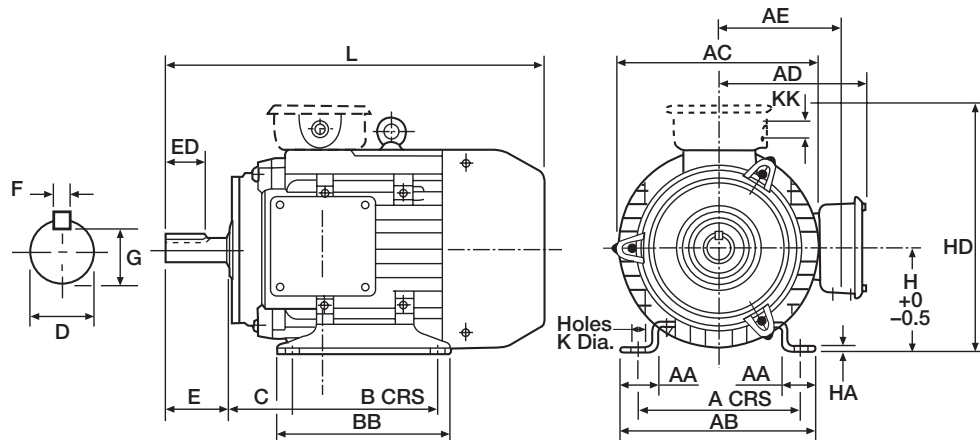

Frame Size	Fixing					Shaft					General							
	A	B	C	H	K	D	E	F	G	ED	AA	AB	BB	Typical L	HA	AC	AD	HD
<b>D63</b>	100	80	40	63	7	11	23	3	8.5	10	19	119	100	207	2	126	—	169
<b>D71</b>	112	90	45	71	7	14	30	5	11	14	19	131	110	251	2	126	—	177
<b>D80</b>	125	100	50	80	10	19	40	6	15.5	25	27	157	127	295	4	158	132	212
<b>D90S</b>	140	100	56	90	10	24	50	8	20	32	28	174	127	314	4	178	140	230
<b>D90L</b>	140	125	56	90	10	24	50	8	20	32	28	174	152	339	4	178	140	230
<b>D100L</b>	160	140	63	100	12	28	60	8	24	40	28	184	170	371	4	208	138	251
<b>D112M</b>	190	140	70	112	12	28	60	8	24	40	37	214	170	384	4	243	192	233
<b>D132S</b>	216	140	89	132	12	38	80	10	33	56	38	243	208	463	5	243	234	371
<b>D132M</b>	216	178	89	132	12	38	80	10	33	56	38	243	208	463	5	243	234	271
<b>D160M</b>	254	210	108	160	15	42	110	12	37	80	49	304	304	598	5	329	278	328
<b>D160L</b>	254	254	108	160	15	42	110	12	37	80	49	304	304	598	5	329	278	328
<b>D180M</b>	279	241	121	180	15	48	110	14	42.5	80	51	329	329	698	8	388	317	375
<b>D180L</b>	279	279	121	180	15	48	110	14	42.5	80	51	329	329	698	8	388	317	375
<b>D200L</b>	318	305	133	200	19	55	110	16	49	80	60	380	379	745	10	453	357	410

## TYPICAL METRIC FLANGE MOUNTED MOTOR DIMENSIONS

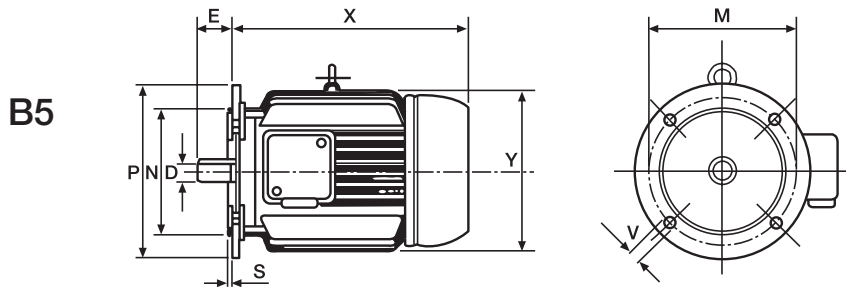

MOTOR SIZE	2 POLES		4 POLES		6 POLES		D	E	N	M	P	S	V	TYPICAL X	Y
	HP	KW	HP	KW	HP	KW									
56 A	0.12	0.09	0.08	0.06	—	—	9	20	80	100	120	2.5	7	167	102
56 B	0.16	0.12	0.12	0.09	—	—									
63 A	0.25	0.18	0.16	0.12	—	—	11	23	95	115	140	3	9	185	122
63 B	0.33	0.25	0.25	0.18	—	—									
71 A	0.5	0.37	0.33	0.25	0.25	0.18	14	30	110	130	160	3.5	9	211	140
71 B	0.75	0.55	0.5	0.37	0.33	0.25									
80 A	1	0.75	0.75	0.55	0.5	0.37	19	40	130	165	200	3.5	11	231	164
80 B	1.5	1.1	1	0.75	0.75	0.55									
90 S	2	1.5	1.5	1.1	1	0.75	24	50	130	165	200	3.5	11	245	181
90 L	3	2.2	2	1.5	1.5	1.1								270	
90 LL	—	—	2.5	1.8	—	—								292	
100 LA	4	3	3	2.2	2	1.5	28	60	180	215	250	4	14	304	207
100 LB	—	—	4	3	—	—								304	
112 M	5.5	4	5.5	4	3	2.2								343	
132 S	7.5-10	5.5-7.5	7.5	5.5	4	3	38	80	230	265	300	4	14	364	259
132 M	12.5	9	10	7.5	5.5-7.5	4-5.5								402	
132 L	—	—	12.5	9	—	—								402	
160 M	15-20	11-15	15	11	10	7.5	42	110	250	300	350	5	18	540	335
160 L	25	18.5	20	15	15	11								11	
180 M	30	22	25	18.5	—	—	48	110	250	300	350	5	18	600	374
180 L	35	26	30	22	20	15								15	
200 L	40-50	30-37	40	30	25-30	18.5-22	55	110	300	350	400	5	18	656	416
225 S	—	—	50	37	—	—	* 60	140	350	400	450	5	18	680	416
225 M	60	45	60	45	40	30								30	
250 M	75	55	75	55	50	37	* 65	140	450	500	550	5	18	742	490
280 S	100	75	100	75	60	45	* 75	140	450	500	550	5	18	892	490
	125	90	125	90	75	55								55	

\* For 2 poles motors: Gr. 225 D = 55; E = 110      Gr. 250 D = 60; E = 140      Gr. 280 D = 65; E = 140

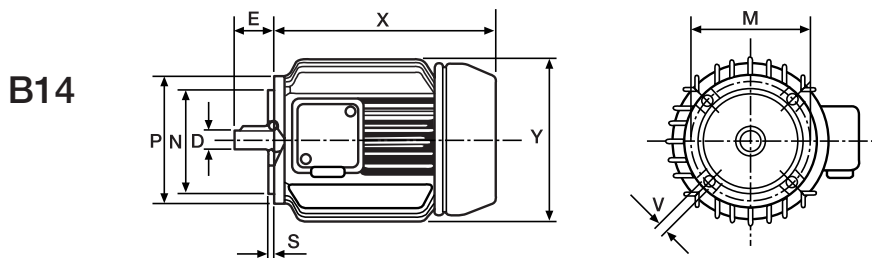

MOTOR SIZE	2 POLE		4 POLE		6 POLE		D	E	N	M	P	S	V	TYPICAL X	Y
	HP	KW	HP	KW	HP	KW									
63 A	0.25	0.18	0.16	0.12	—	—	11	23	60	75	90	2.5	M5	185	122
63 B	0.33	0.25	0.25	0.18	—	—									
71 A	0.5	0.37	0.33	0.25	0.25	0.18	14	30	70	85	105	2.5	M6	211	140
71 B	0.75	0.55	0.5	0.37	0.33	0.25									
80 A	1	0.75	0.75	0.55	0.5	0.37	19	40	80	100	120	3	M6	231	164
80 B	1.5	1.1	1	0.75	0.75	0.55									
90 S	2	1.5	1.5	1.1	1	0.75	24	50	95	115	140	3	M8	245	181
90 L	3	2.2	2	1.5	1.5	1.1								270	
90 LL	—	—	2.5	1.8	—	—								292	
100 LA	4	3	3	2.2	2	1.5	28	60	110	130	160	3.5	M8	304	207
100 LB	—	—	4	3	—	—								304	
112 M	5.5	4	5.5	4	3	2.2	28	60	110	130	160	3.5	M8	343	207



# LOCKED ROTOR CODE LETTERS

## and

# REDUCED VOLTAGE STARTING METHODS

When AC motors are started with full voltage (Across-the-Line Starting), they draw line amperage 300% to 600% greater than their full load running current. The magnitude of the “inrush current” (also called locked rotor amps or LRA) is determined by motor horsepower and design characteristics. To define inrush characteristics and present them in a simplified form, code letters are used. Code letters group motors depending on the range of inrush values and express the inrush in terms of KVA (Kilovolt Amperes). By using the Kilovolt ampere basis, a single letter can be used to define both the low and high voltage inrush values on dual voltage motors.

The code letter designations and their values appear in Table I.

CODE LETTER	KVA/HP RANGE	APPROXIMATE MID-RANGE VALUE	CODE LETTER	KVA/HP RANGE	APPROXIMATE MID-RANGE VALUE
A	0.00 - 3.15	1.6	L	9.0 - 10.0	9.5
B	3.15 - 3.55	3.3	M	10.0 - 11.2	10.6
C	3.55 - 4.0	3.8	N	11.2 - 12.5	11.8
D	4.0 - 4.5	4.3	P	12.5 - 14.0	13.2
E	4.5 - 5.0	4.7	R	14.0 - 16.0	15.0
F	5.0 - 5.6	5.3	S	16.0 - 18.0	17.0
G	5.6 - 6.3	5.9	T	18.0 - 20.0	19.0
H	6.3 - 7.1	6.7	U	20.0 - 22.4	21.2
J	7.1 - 8.0	7.5	V	22.4 - and up	
K	8.0 - 9.0	8.5			

*Table 1*

To determine starting inrush amperes from the code letter, the code letter value (usually the mid-range value is adequate), horsepower and rated operating voltage are inserted in the appropriate equation. The equation to be used is determined by whether the motor is single or three phase.

$$\text{INRUSH AMPERES (SINGLE PHASE MOTORS)} = \frac{(\text{CODE LETTER VALUE}) \times \text{HP} \times 1000}{\text{RATED VOLTAGE}}$$

$$\text{INRUSH AMPERES (THREE PHASE MOTORS)} = \frac{(\text{CODE LETTER VALUE}) \times \text{HP} \times 577}{\text{RATED VOLTAGE}}$$

The following simplified equations for three phase motors will give approximate results for 3 phase motors rated for 200, 230, 460 or 575 volts:

- 200 volts LRA = Code Letter Value x HP x 2.9
- 230 volts LRA = Code Letter Value x HP x 2.5
- 460 volts LRA = Code Letter Value x HP x 1.25
- 575 volts LRA = Code Letter Value x HP x 1.0

## STARTING METHODS

Across the line starting is used on a high percentage, probably over 95% of normal motor applications. Other starting methods (reduced voltage) are used mainly to control inrush current and limit it to values that can be safely handled without excessive voltage dips and the accompanying light flicker. Occasionally, reduced voltage starters are used to reduce starting torque for smoother acceleration of loads. Various methods of reduced voltage starting have been developed. Table 2 shows the common reduced voltage starter types and the results that can be expected in terms of motor voltage, line current, and the output torque of the motor. Caution should be used in applying reduced voltage starters on certain types of loads. For example, a centrifugal pump, which is very easy to start, can be operated with either wye-delta starting or part winding starting. These starting methods produce 33% and 50% of rated motor starting torque respectively and can easily start centrifugal pumps. They could also be expected to start a compressor so long as it is unloaded. They could have difficulty starting a loaded inclined conveyor or a positive displacement pump because of high starting torques required on these types of loads. The best starting method has to be one that achieves the desired result in inrush reduction and yields adequate starting torque to reliably start the load.

### SQUIRREL CAGE INDUCTION MOTORS

Starting Method	% of Full Voltage Value*		
	Voltage at Motor	Line Current	Motor Output Torque
Full Voltage	100	100	100
Autotransformer	80 % tap	64**	64
	65 % tap	42**	42
	50 % tap	25**	25
Primary reactor	80 % tap	80	64
	65 % tap	65	42
	50 % tap	50	25
Primary resistor Typical Rating	80	80	64
Part Winding High Speed Motors (1/2 - 1/2)	100	70	50
Wye Start – Delta Run	100	33	33

\* Percent of "Across The Line Value".

\*\* Autotransformer magnetizing current not included. Magnetizing current usually less than 25 percent motor full-load current.

*Table 2*

In all cases, reduced voltage starters will cost substantially more than full voltage (across the line) starters. Standard motors can be used with autotransformer, primary reactor and primary resistor type starters. In addition, dual voltage motors can usually be utilized with part winding starters but only at the low voltage. Generally speaking, wye delta motors and part winding motors for higher voltage (for example, 460 or 575 volts) must be made to order. This will raise the cost of the motor over a standardly available motor suitable for use on other types of reduced voltage starting.

## **SOLID STATE STARTERS**

So far we have discussed the traditional types of reduced voltage starters. The newer arrival is the solid state soft-start control. With this type of device, the voltage is gradually raised electronically from a low value at which the motor starts to turn the load up to the final across the line operating voltage. This type of starter has the advantage of giving smoothly controlled acceleration and substantially reduced inrush current.

### **SUMMARY**

Overall, it is important to note that one of the primary objectives of reduced voltage starting is to limit the inrush current to a value that the power system or the local utility will accept. There are fringe benefits derived from all types of reduced voltage starting. Reduced torque values that result from the lower applied voltage also reduce wear and tear on couplings, belts, gears and other equipment that is being powered by the motor. Solid state starters offer a smooth transition from standstill to full speed with reduced line current, controlled motor torque and acceleration.



# **UNDERSTANDING TORQUE**

**EDWARD H. COWERN, P.E.**

# UNDERSTANDING TORQUE

## TABLE OF CONTENTS

	Page
Introduction . . . . .	33
Torque Basics . . . . .	33
Horsepower . . . . .	34
Variable Speed Drives . . . . .	34
Constant Torque Loads . . . . .	34
Constant Horsepower Loads . . . . .	35
Horsepower/Torque Table . . . . .	35
Variable Torque Loads . . . . .	36
High Inertia Loads . . . . .	37
Reflected Inertias . . . . .	39
Linear Motion Inertia . . . . .	40
Summary . . . . .	40

# UNDERSTANDING TORQUE

Edward H. Cowern, P.E.

In the process of applying industrial drive products, we occasionally are misled into believing that we are applying horsepower. The real driving force is not horsepower, it is TORQUE. This paper is developed to give a deeper understanding of torque, its relationship to horsepower, and the types of loads we most frequently encounter.

## INTRODUCTION

Torque is the twisting force supplied by a drive to the load. In most applications, a substantial amount of torque must be applied to the driven shaft before it will even start to turn. In the English System, the standard units of torque as used in the power transmission industry are pound inches (lb. in.), or pound feet (lb. ft.) and, in some cases, for very low levels of torque, you will encounter ounce inches (oz. in.).

## TORQUE BASICS

At some time, we have all had difficulty in removing the lid from a jar. The reason we have this trouble is simply that we are unable to supply adequate torque to the lid to break it loose. The solution to our dilemma may be to: 1) grit our teeth and try harder, 2) use a rubber pad, or cloth, to increase the ability to transmit torque without slippage, or 3) use a mechanical device to help multiply our torque producing capability. Failing on all of the above, we may pass the jar to someone stronger who can produce more torque.

If we were to wrap a cord around the lid and supply a force to the end of the cord through a scale, as shown in Figure 1, we could get the exact measurement of the torque it takes to loosen the lid.

The torque required would be the force as indicated on the scale., multiplied by the radius of the lid.

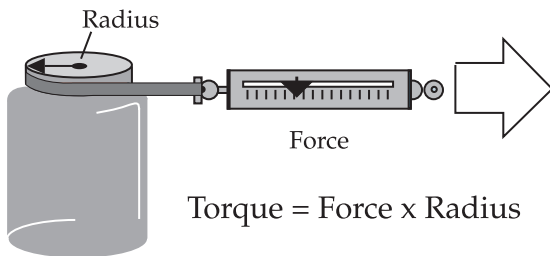

Figure 1

For example, if the indicated force on the scale at the time of "breakaway" was 25 lbs. and the radius

of the lid was 1.5 inches, the torque required would have been:

$$T = 25 \text{ lbs.} \times 1.5 \text{ in.} = 37.5 \text{ lb. inches}$$

Although this example does give a reasonable illustration of "torque", it does not represent a very common example of requirements on industrial equipment.

There is, however, one additional important point that can be derived from the jar and the lid example; namely "Sticksion". "Sticksion" is a term generated to indicate the amount of torque required to break a load loose on its way to making the first revolution.

Generally speaking, the breakaway torque requirement to start a machine will be substantially greater than that required to keep it running once it has started. The amount of "sticksion" present in a machine will be dependent on the characteristics of the machine as well as the type of bearings that are used on the moving parts.

Table I indicates typical values of breakaway torque for various general classifications of machinery.

## BREAKAWAY & STARTING TORQUE CHARACTERISTICS OF VARIOUS TYPES OF LOADS

Torque	% of Running Torque	Types of Machines
Breakaway Torque	120% to 130%	General machines with ball or roller bearings
Breakaway Torque	130% to 160%	General machines with sleeve bearings
Breakaway Torque	160% to 250%	Conveyors and machines with excessive sliding friction
Breakaway Torque	250% to 600%	Machines that have "high" load spots in their cycle, such as some printing and punch presses, and machines with "cam" or "crank" operated mechanisms.

Table 1

Assuming that the "sticksion", or breakaway torque, has been overcome and the load has started, a continuing amount of torque must be supplied to handle the running torque requirements of the machine.

In a high percentage of industrial applications, the torque requirement of the load is independent of the speed at which the machine is driven. This type of load is generally called a “constant torque load”.

Constant torque loads will be used to introduce the basic concepts of horsepower. Additional load types will be introduced after the discussion of horsepower.

## HORSEPOWER

Many years ago, the invention of the steam engine made it necessary to establish a unit of measurement that could be used as a basis for comparison for how much work could be done by an engine. The unit that was chosen was related to the animal that was to be replaced by the new sources of power – the horse.

After a great deal of testing, it was found that the average work-horse could accomplish work at a rate equal to 33,000 ft. lbs. in one minute. This would be equal to lifting 1 ton (2,000 lbs.) 16.5 feet, or 1,000 lbs., 33 feet in one minute.

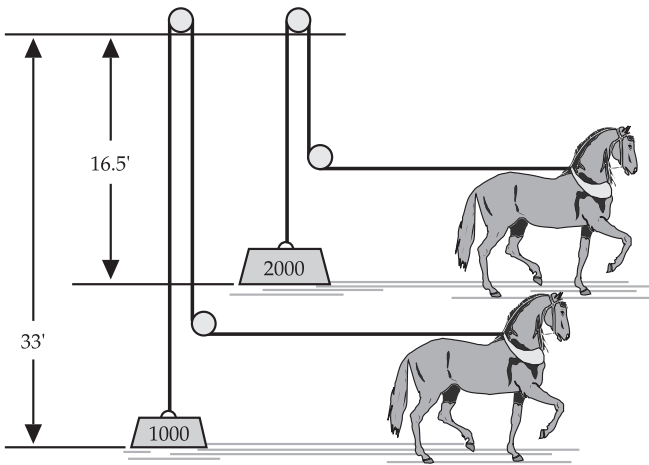

Figure 2

This unit, once established, has become the Western Hemisphere’s standard for measuring the rate at which motors and other drives can produce work. For example, a 1 H.P. motor can produce 33,000 ft. lbs. of work in one minute.

Torque and horsepower are related to each other by a basic formula which states that:

$$\text{Horsepower} = \frac{\text{Torque} \times \text{Speed}}{\text{Constant}}$$

The value of the constant changes depending upon the units that are used for torque. The most frequently used combinations are as follows:

$$\text{HP} = \frac{T \times S}{5252} \quad \begin{array}{l} T = \text{TORQUE IN LB. FT.} \\ S = \text{SPEED IN RPM} \end{array}$$

OR

$$\text{HP} = \frac{T \times S}{63,025} \quad \begin{array}{l} T = \text{TORQUE IN LB. IN.} \\ S = \text{SPEED IN RPM} \end{array}$$

OR

$$\text{HP} = \frac{T \times S}{1,000,000} \quad \begin{array}{l} T = \text{TORQUE IN IN. OUNCES} \\ S = \text{SPEED IN RPM} \end{array}$$

Re-arranging these formulas to obtain torque, we can arrive at the equations:

$$T = \frac{\text{HP} \times 5252}{S} \quad \begin{array}{l} T = \text{TORQUE IN LB. FT.} \\ S = \text{SPEED IN RPM} \end{array}$$

OR

$$T = \frac{\text{HP} \times 63,025}{S} \quad \begin{array}{l} T = \text{TORQUE IN LB. IN.} \\ S = \text{SPEED IN RPM} \end{array}$$

OR

$$T = \frac{\text{HP} \times 1,000,000}{S} \quad \begin{array}{l} T = \text{TORQUE IN IN. OUNCES} \\ S = \text{SPEED IN RPM} \end{array}$$

In order to save time, graphs and tables are frequently used to show values of torque, speed and horsepower.

The previous discussion applies to calculations for all single speed loads where the required torque and speed for a given operating condition are known.

## ADJUSTABLE SPEED DRIVES

When adjustable speed drives such as DC SCR units, magnetic couplings, or variable frequency drives are to be utilized, a determination of load type must be made.

As previously mentioned, the most common type of load is the “constant torque” load. The relationships of torque and horsepower to speed for a “constant” torque load is shown in Figure 3.

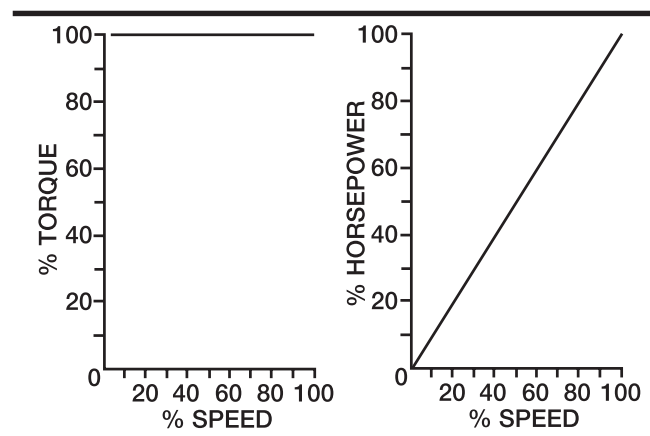

Constant Torque Speed-Torque Relationship

Figure 3



In the case of “constant torque” loads, the drive must be sized to handle:

- 1) The torque required to breakaway the load.
- 2) The torque required to run the load.
- 3) The output speed required to operate the machine at the maximum required speed.

Please note that only after the load has 1) been started and 2) adequate torque is available to run it, does speed become a factor.

Only after these three items have been determined, is it possible to calculate the required horsepower for the application.

Most adjustable speed drives are inherently “constant torque” devices; therefore, no special considerations are involved in handling “constant torque” loads.

### CONSTANT HORSEPOWER

A load type that occurs most frequently in metal working applications, is the Constant Horsepower load.

On applications requiring constant horsepower, the torque requirement is greatest at the lowest speed and diminishes at higher speeds. In order to visualize this requirement, consider the torque requirements of a drill press, as shown in Figure 4.

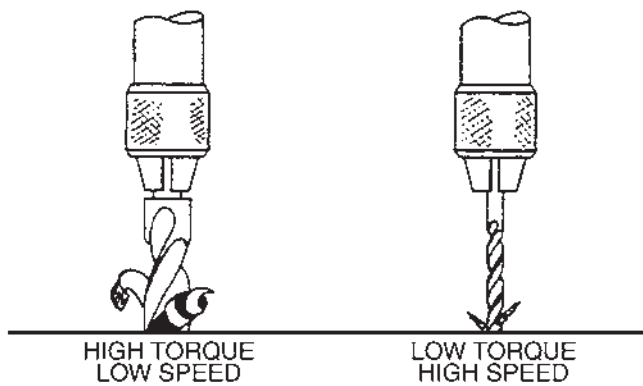

$$HP = \frac{TS}{5250} = \frac{TS}{5250}$$

Figure 4

When a large hole is being drilled, the drill is operated at a low speed, but it requires a very high torque to turn the large drill in the material.

When a small hole is being drilled, the drill is operated at a high speed, but it requires a very low torque to turn the small drill in the material.

A mathematical approach to this type of requirement would indicate that the HP requirement would be nearly constant regardless of the machine speed. Figure 5 shows the relationships of torque and horsepower to speed on constant horsepower loads.

As previously mentioned, this load type occurs most frequently on metal working applications, such as: drilling or boring, tapping, turning (lathes), planing, milling, grinding, wire drawing, etc. Center driven winders winding materials under constant tension also require constant horsepower. Constant horsepower can also be a requirement on some types of mixers.

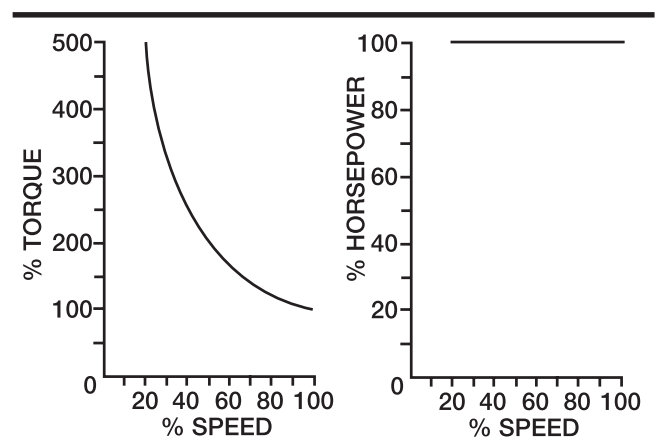

Constant HP Speed-Torque Relationships

Figure 5

An example of this might be a food mixer used to mix a variety of batters and dough. In this case, dough would require low speed and high torque. Thin batters would require high speed and low torque. This is “Constant Horsepower”.

Spring coilers, fourslide machines, punch presses and eyeletting presses will frequently have torque requirements falling somewhere between the characteristics of constant horsepower and constant torque.

A general test for deciding if a machine might require “Constant Horsepower” would be to study the machine output. When a machine is designed to produce a fixed number of pounds per hour regardless of whether it is making small parts at high speed, or large parts at a lower speed, the drive requirement is apt to be “Constant Horsepower”.

Although details of selecting drives for constant horsepower loads are beyond the scope of this

presentation, some possibilities are as follows. “Constant Horsepower” loads can be handled by oversizing drives such as standard SCR units or slip couplings. This is done by matching the drive’s output torque with the machine’s requirement at the low speed. Depending upon the speed range that is required, this can result in gross oversizing at the high speed. More practical approaches involve using stepped pulleys, gearshift transmissions and metallic or rubber belt adjustable pitch pulley drives. Some additional and more sophisticated approaches are DC (SCR) drives operating with a combination of armature control at full field power up to base speed and field weakening above base speed. Some variable frequency drives can also be used at frequencies above 60 HZ., with voltage held constant to achieve a moderate amount of constant horsepower speed range.

**VARIABLE TORQUE**

The final load type that is often encountered is the “Variable Torque” load. In general, variable torque loads are found only in centrifugal pumps, fans and blowers.

A cross section of a centrifugal pump is shown in Figure 6. The torque requirement for this load type can be thought of as being nearly opposite that of the “Constant Horsepower” load. For a variable torque load, the torque required at low speed is very low, but the torque required at high speed is very high. Mathematically, the torque requirement is a function of the speed squared and the horsepower is a function of the speed cubed.

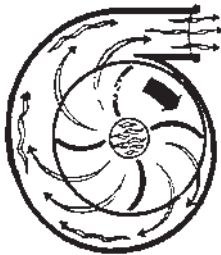

Centrifugal Pump — Variable Torque Load  
Figure 6

The relationships of torque and horsepower to speed on “Variable Torque” loads are shown in Figure 7.

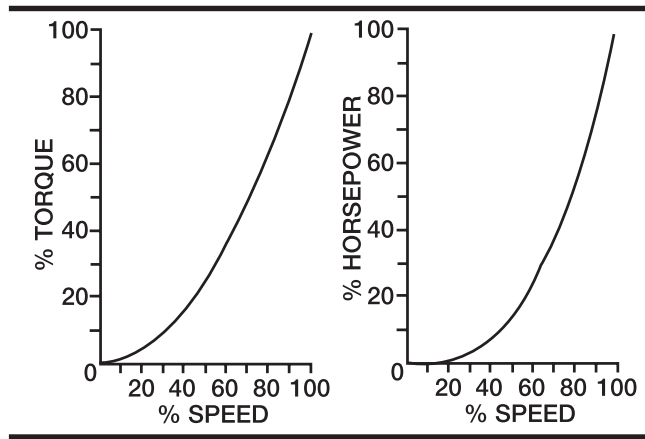

Variable Torque — Speed-Torque Relationships  
Figure 7

The key to drive sizing on “Variable Torque” loads is strictly related to providing adequate torque and horsepower at the MAXIMUM speed that will be required. MAXIMUM must be emphasized since a 9% increase in speed over the normal maximum will produce a 30% increase in the horsepower requirement.

It is impossible to speculate on the number of motors that have been burned out because people have unknowingly changed pulley ratios to obtain “more output” from their centrifugal pumps or blowers.

Table 2 illustrates the very dramatic changes in horsepower requirements for relatively small changes in speeds that occur with “Variable Torque” loads.

<u>% Speed Change</u>	<u>% Torque Change</u>	<u>% of Original HP</u>	<u>% HP Change</u>
-20	-36	51	-49
-15	-28	61	-39
-10	-19	73	-27
- 5	-10	86	-14
0	0	100	0
+5	+10	116	+16
+10	+21	133	+33
+15	+32	152	+52
+20	+44	173	+73

Table 2

Most variable speed drives are inherently capable of handling “Variable Torque” loads provided that they are adequately sized to handle the horsepower requirement at MAXIMUM speed.

## HIGH INERTIA LOADS\*

A discussion of load types would not be complete without including information on “High Inertia Loads”.

Inertia is the tendency of an object that is at rest to stay at rest or an object that is moving to keep moving.

In the industrial drive business, we tend to think immediately of flywheels as having high inertia; but, many other types of motor driven equipment, such as: large fans, centrifuges, extractors, hammer mills, and some types of machine tools, have inertias that have to be identified and analyzed in order to produce satisfactory applications.

\*A load is generally considered to be “High Inertia” when the reflected inertia at the motor shaft is greater than five times the motor rotor inertia.

### THE HIGH INERTIA PROBLEM

The high inertia aspect of a load normally has to be considered only during acceleration and deceleration. For example, if a standard motor is applied to a large high inertia blower, there is a possibility that the motor could be damaged or fail completely on its first attempt to start. This failure could occur even though the motor might have more than adequate torque and horsepower capacity to drive the load after it reaches the required running speed.

A good example of high inertia that most of us are familiar with is a jet plane taking off. In this case, the maximum output of the engines is required to accelerate the weight of the plane and contents. Only when it has reached take-off speed and is nearly ready to leave the ground do the engines start doing the useful work of moving the plane to the final destination.

Similarly, when the plane lands, the reversed thrust of the engines and the brakes are used to slow down and stop the inertia of the plane.

In the motor and drive industry, the inertia of a rotating body is referred to as the  $WR^2$  or  $WK^2$ . In the English System, “W” is the weight in pounds and “R” or “K” is the Radius of Gyration in feet. It is usually easy to obtain the weight of the body, but determining the radius of gyration can be a little more difficult. Figure 8 gives the formulas for determining the radius of gyration and  $WR^2$  of two frequently occurring cylindrical shapes.

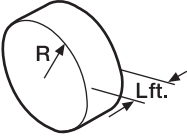
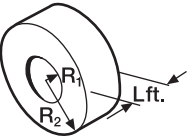
PART	RADIUS OF GYRATION (IN FEET)	SIZE OF LOAD $WR^2 =$ POUNDS X FEET <sup>2</sup>
CIRCULAR CYLINDER 	.71R	$1.58 W L R^4$ $(R^4 = R \times R \times R \times R)$ W = weight in pounds of one cubic foot of the material
HOLLOW CIRCULAR CYLINDER 	$.71 \sqrt{R_2^2 + R_1^2}$	$1.58 w L (R_2^4 - R_1^4)$ W = weight in pounds of one cubic foot of the material

w: Steel = 490      Cast Iron = 450      Aluminum = 165

Figure 8

In most cases, the  $WR^2$  of flywheels can be determined by utilizing one, or both, of these normal shapes. In the case of flywheels having spokes, the contribution made by the spokes can generally be ignored and the inertia calculation based only on the formula for a Hollow Circular Cylinder as shown in Figure 8. The weight of the spokes should be included. If exact calculations are required, formulas are available to enable the calculation of  $WR^2$  values of nearly any shape.

In most cases, equipment manufacturers will be able to provide the exact inertia values for a given application.

Motor manufacturers can be asked to supply the maximum  $WK^2$  limits for any specific application requirement. (Please note  $WK^2$  and  $WR^2$  are used interchangeably and they are the same).

The values shown in Table 3 are published in NEMA (National Electrical Manufacturers Association) standards MG 1. This table gives a listing of the normal maximum values of  $WK^2$  that could be safely handled by standard motors. This table can be used as a guide. If the required  $WK^2$  exceeds these values, the motor manufacturer should be consulted. It is also important to note the details of paragraphs 1, 2, and 3 that are associated with this table. If the number of starts required or the method of starting is not “across the line”, the manufacturer should be consulted.

## WHY IS HIGH INERTIA A PROBLEM?

Prior to the time that a standard induction motor reaches operating speed, it will draw line current several times the rated nameplate value. The high

current does not cause any problem if it is of short duration; but, when the high currents persist for an extended period of time, the temperature within the motor can reach levels that can be damaging.

HP	Speed, RPM						
	3600	1800	1200	900	720	600	514
	Load WK <sup>2</sup> (Exclusive of Motor WK <sup>2</sup> ), Lb-Ft <sup>2</sup>						
1	—	5.8	15	31	53	82	118
1 <sup>1</sup> / <sub>2</sub>	1.8	8.6	23	45	77	120	174
2	2.4	11	30	60	102	158	228
3	3.5	17	44	87	149	231	335
5	5.7	27	71	142	242	375	544
7 <sup>1</sup> / <sub>2</sub>	8.3	39	104	208	355	551	799
10	11	51	137	273	467	723	1050
15	16	75	200	400	684	1060	1540
20	21	99	262	525	898	1390	2020
25	26	122	324	647	1110	1720	2490
30	31	144	384	769	1320	2040	2960
40	40	189	503	1010	1720	2680	3890
50	49	232	620	1240	2130	3300	4790
60	58	275	735	1470	2520	3820	5690
75	71	338	904	1810	3110	4830	7020
100	92	441	1180	2370	4070	6320	9190
125	113	542	1450	2920	5010	7790	11300
150	133	640	1720	3460	5940	9230	—
200	172	831	2240	4510	7750	—	—
250	210	1020	2740	5540	—	—	—
300	246	1200	3240	—	—	—	—
350	281	1370	3720	—	—	—	—
400	315	1550	—	—	—	—	—
450	349	1710	—	—	—	—	—
500	381	1880	—	—	—	—	—

### Copyright NEMA MG 1

### Load WK<sup>2</sup> for Integral horsepower Polyphase Squirrel-cage Induction Motors

The table shown above lists the load WK<sup>2</sup> which integral-horsepower polyphase squirrel-cage induction motors, having performance characteristics in accordance with Part 12\*, can accelerate without injurious heating under the following conditions:

1. Applied voltage and frequency in accordance with 12.44.
2. During the accelerating period, a connected load torque equal to or less than a torque which varies as the square of the speed and is equal to 100 percent of rated-load torque at rated speed.

3. Two starts in succession (coasting to rest between starts) with the motor initially at the ambient temperature or one start with the motor initially at a temperature not exceeding its rated load operating temperature.

\* Locked-rotor torque in accordance with 12.38.1, breakdown torque in accordance with 12.39.1, Class A or B insulation system with temperature rise in accordance with 12.43, and service factor in accordance with 12.51.2.

Table 3

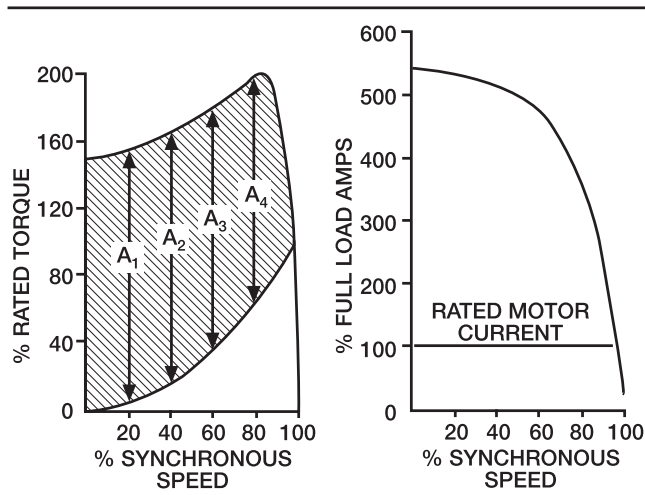

Figure 9(a)

Figure 9(b)

Figure 9 (a) shows typical plots of available torque from a standard motor vs. speed. Also plotted on curve (a) is the typical speed torque curve for a Variable Torque load. The values of A<sub>1</sub>, A<sub>2</sub>, A<sub>3</sub>, and A<sub>4</sub> are the values of torque available to overcome the effect of the inertia and accelerate the load at different motor speeds as the motor speed increases.

Referring to Figure 9 (b), you will see that during the accelerating period this motor will draw line current that initially starts at 550% of rated current and gradually drops off as the motor approaches rated speed. A great deal of heat is generated within the motor during this high current interval. It is this heat build up that is potentially damaging to the motor if the acceleration interval is too long.

### HOW LONG WILL IT TAKE?

Calculating the time to accelerate a direct coupled load can be determined quite easily by utilizing the following formula:

$$t = \frac{WR^2 \times N}{308T}$$

T = AVERAGE ACCELERATING TORQUE IN LB. FT.

N = REQUIRED CHANGE IN SPEED

WR<sup>2</sup> = INERTIA IN LB. FT.<sup>2</sup>

t = TIME IN SECONDS

The same formula can be rearranged to determine the average accelerating torque required to produce full speed in a given period of time.

$$T = \frac{WR^2 \times N}{308t}$$

Referring back to Figure 9 (a), the accelerating torque would be the average value of the shaded area. In

most cases, for standard motors through 100 HP, it is reasonable to assume that average accelerating torque available would be 150% of the motor full load running torque and that accelerating times of 8-10 seconds, or less, would not be damaging provided that starting is not repeated frequently. When load inertias exceed those shown in Table 4, the application should be referred to the motor supplier for complete analysis.

### REFLECTED INERTIAS

Up to this point, the only load inertias that have been considered have been rotating inertias directly connected to the motor shaft.

On many applications, the load is connected to the motor by belts or a gear reducer. In these cases, the “Equivalent Inertia” or “Reflected Inertia” that is seen at the motor shaft is the important consideration.

In the case of belted or geared loads, the “Equivalent Inertia” is given by the following formula:

$$\text{EQUIVALENT } WR^2 = WR^2_{\text{LOAD}} \left[ \frac{N}{N_M} \right]^2 \times 1.1^*$$

WR<sup>2</sup><sub>LOAD</sub> = INERTIA OF THE ROTATING PART

N = SPEED OF THE ROTATING PART

N<sub>M</sub> = SPEED OF THE DRIVING MOTOR

\*Please note: the x 1.1 factor has been added as a safety factor to make an allowance for the inertia and efficiency of the pulleys (sheaves) or gears used in the speed change.

This formula will apply regardless of whether the speed of the load is greater than, or less than, the motor speed.

Once the equivalent inertia has been calculated, the equations for accelerating time, or required torque, can be solved by substituting the equivalent WR<sup>2</sup> in the time or torque equation to be solved.

### WHAT CAN BE DONE

When loads having high inertias are encountered, several approaches can be used. Some of the possibilities are:

1. Oversize the motor.
2. Use reduced voltage starting.
3. Use special motor winding design.
4. Use special slip couplings between the motor and load.
5. Oversize the frame.
6. Use an adjustable speed drive.

## LINEAR MOTION

Occasionally, applications arise where the load to be accelerated is traveling in a straight line rather than rotating. In this case, it is necessary to calculate an equivalent  $WR^2$  for the body that is moving linearly. The equation for this conversion is as follows:

$$\text{EQUIVALENT } WR^2 = \frac{W(V)^2}{39.5 (S_M)^2}$$

W = WEIGHT OF LOAD IN POUNDS

V = VELOCITY OF THE LOAD IN FEET PER MINUTE

$S_M$  = SPEED OF THE MOTOR IN RPM WHEN LOAD IS MOVING AT VELOCITY V

Once the equivalent  $WR^2$  has been calculated, acceleration time, or required accelerating torque, is calculated by using the same equations for rotating loads.

## SUMMARY

The turning force on machinery is torque, not horsepower.

Horsepower blends torque with speed to determine the total amount of work that must be accomplished in a span of time.

In all cases, the horsepower required for single speed application can be determined by utilizing the torque required at rated speed along with the required speed.

When variable speed drives are to be utilized, an additional determination of load type has to be made. Most applications require either Constant Torque or Variable Torque. Metal cutting and metal forming applications frequently will require Constant Horsepower.

High inertia loads need to be approached with some caution due to high currents absorbed by the motors during the starting period. If there is any question regarding safe accelerating capabilities, the application should be referred to the motor manufacturer.

An understanding of torque is essential for proper selection of any drive product.

---

## GLOSSARY OF TERMS

Torque	... Twisting force measured in pounds-inches, pounds-feet, or ounce-inches.
Horsepower	... A measurement of work done per unit of time. 33,000 foot pounds per minute = 1 H.P.
Stiction	... A word used to describe the torque required to breakaway a load.
Constant Torque Load	... A load where the driving torque requirement is independent of speed.
Variable Speed Drives	... A driving device whose speed is adjustable to provide for changes in speed flow or rate.
Load Type	... Classifications of loads by their torque and horsepower requirements as related to speed.
Constant Horsepower	... A load type where the torque requirement is greatest at low speeds and reduces at higher speeds.
Variable Torque	... A load type where the torque required to drive a load increases with speed. This load type is usually associated with centrifugal pumps and blowers.
Inertia	... The tendency of a load to resist increases or decreases in speed.
High Inertia Loads	... Loads exhibiting a flywheel characteristic.
$WR^2$ or $WK^2$	... A measure of inertia related to the weight and radius of gyration of a rotating body.
Radius of Gyration	... A radius at which the entire weight of a body can be assumed to exist for purposes of inertia calculations.
NEMA	... National Electrical Manufacturers Association. A body charged with establishing many industry standards for electrical equipment.
Direct Connected Loads	... A load coupled directly to the motor shaft where the load speed is the same as the motor speed.
Reflected Inertia	... Used to relate load inertia to the motor shaft for loads driven through speed increasing or decreasing belt or gear ratios. Also called "Equivalent Inertia".
Linear Motion	... Straight line motion as encountered in cars and conveyors of various types.



# FANS, BLOWERS, AND OTHER FUNNY LOADS

A family of motor applications that tend to confuse people who are not regularly involved with them, is that of Variable Torque Loads. These loads represent a high percentage of motor requirements, so it is desirable to have a little extra knowledge of the mysterious aspects of these loads. First, Variable Torque Loads are fans, blowers, and centrifugal pumps. In general fans and blowers are moving air but centrifugal pumps can be moving many kinds of liquids including water, petroleum products, coolants, etc.

There are two mysterious characteristics that these loads have. The first is the way they act when the speed is changed. The rules that cover these characteristics are called the “affinity laws”. In order to simplify we will discuss only the performance of these loads when they are applied to systems where the load is not changing. For example, we can discuss a pump arrangement as shown in Figure 1. This is a pump circulating chilled or hot water through a closed system. What we find is that the torque required to drive the pump goes up as a squared function of speed ( $\text{Speed}^2$ ). Thus, increasing the speed causes the torque required by the pump to go up, not directly with speed, but in proportion to the change of speed squared. For example, if we change the speed from 1,160 to 1760 RPM the torque required will go up by the ratio of  $(1760 \div 1160)^2$ . This would mean that the torque required would go up by 2.3 times to 230% of the original value. Also, since horsepower (HP) is based on speed times torque, and the speed has increased by 52%, the new value of HP would be  $2.30 \times 1.52$  or almost 350% of the HP required at the original speed.

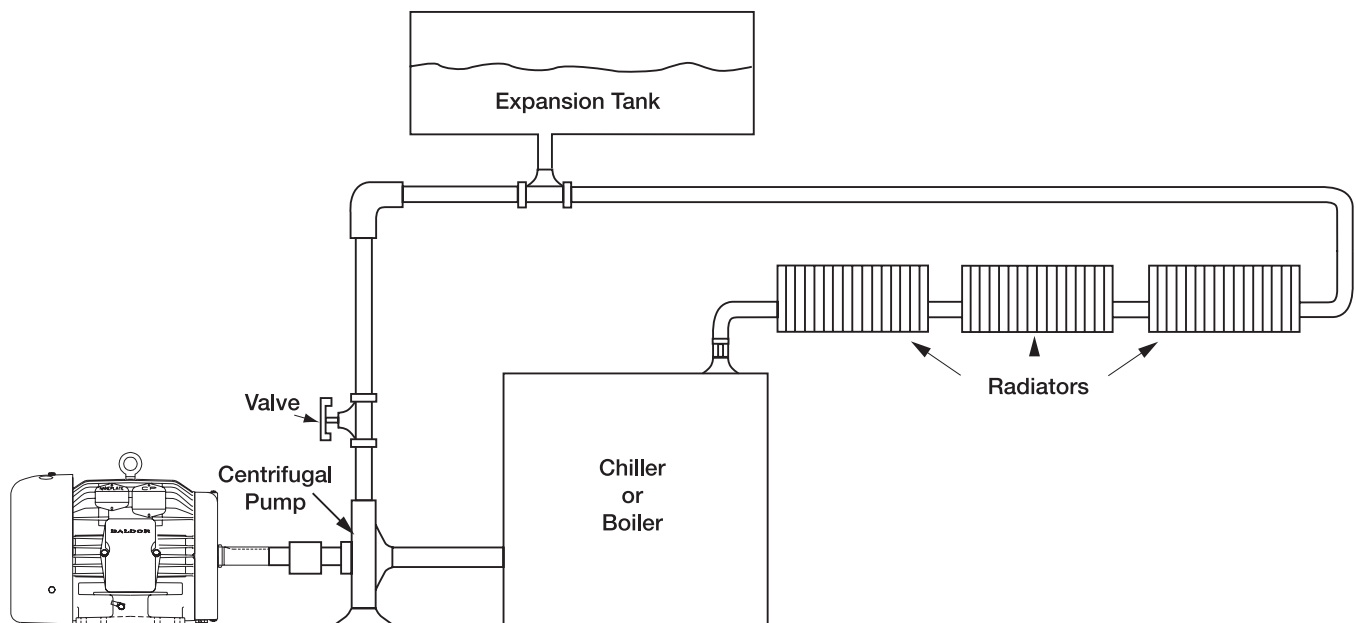

**Water Circulation System**

The dramatic increases in the horsepower required to drive these loads when speed increases is a little difficult to understand but it is very important. It is also important because small decreases can result in great energy savings. For example, decreasing the speed of a variable torque load by only 20% will result in a driving energy reduction of nearly 50%. This, obviously, has big importance when conservation is considered. It also accounts for the tremendous market that exists for variable frequency drives operating Variable Air Volume (VAV) systems used in heating, ventilating, air conditioning and variable speed pumping used in similar systems.

The second puzzling thing that occurs with variable torque loads is that the motor load actually decreases as the output or input to the blower or pump is blocked off or restricted. This would be the situation in Figure 1 as the valve is closed. The reverse of this is that motor load increases dramatically as restrictions are removed. As an example of this, I once had a call from a motor user who had burned out a motor driving a blower on a heating system. The motor was driving a blower that drew air through a filter and fed it to a ducted distribution system. When I asked if there had been any changes in the system he said, "Well, we extended the ducts into another room and cut the end off to let the air flow, but that would have made it easier for the motor not more difficult." When I told him that the opposite was true he couldn't believe it. It defies good judgement to think that adding a restriction to the output of the blower would decrease the motor load. If you don't believe it, here's a simple test. Take a vacuum cleaner and listen to it carefully while you alternately open and close the suction. At first you might think that the "heavier" noise is the motor straining when the suction is the greatest, but if you listen more carefully you will notice that the pitch of the motor goes up when the suction is closed. What this means is that the load is being reduced on the motor and it speeds up. If you still don't believe, you can do the same test but with an ammeter on the motor. What you will find is that the amps drop as the suction level is increased. The same is true of centrifugal pumps. Closing down or restricting the output causes the pump to draw less mechanical power. Another way of looking at this is when the output of a centrifugal pump or a squirrel cage blower is closed off the air or fluid inside the housing becomes a "liquid flywheel". It just spins around with the vanes of the pump or blower. Since there is no new fluid coming in to be accelerated, the only energy needed is what it takes to make up for the friction losses within the housing of the pump or blower. It doesn't seem to make sense, but that's the way it is!

As another example, think of fans applied to dust collection systems, the maximum load occurs when everything is as clean as can be. As the filter bags get coated with dust, the back pressure increases and the load on the blower and motor is reduced.

The amount of overloading or underloading that occurs as a result of changes in the "back pressure" on the pump or blower will depend on the specific design of the impeller used. Some types of pumps and blowers are designed to be non-overloading. But in most cases the worst case loading occurs at the open discharge condition.

## **SUMMARY**

When dealing with Variable Torque loads things are not always as they would seem. If there is some question about how this equipment performs, it is best to contact the equipment manufacturer and discuss the matter.



# RMS HORSEPOWER LOADING

There are a great many applications especially in hydraulics and hydraulically-driven machines that have greatly fluctuating load requirements. In some cases, the peak loads last for relatively short periods during the normal cycle of the machine. At first glance, it might seem that a motor would have to be sized to handle the worst part of the load cycle. For example, if a cycle included a period of time where 18 HP is required, then the natural approach would be to utilize a 20 HP motor. A more practical approach to these types of “duty cycle loads” takes advantage of an electric motor’s ability to handle substantial overload conditions as long as the period of overload is relatively short compared to the total time involved in the cycle.

The method of calculating whether or not the motor will be suitable for a particular cycling application is called the RMS (root mean squared) horsepower loading method. The calculations required to properly size a motor for this type of application are relatively simple and are presented in this paper.

The RMS calculations take into account the fact that heat buildup within the motor is very much greater at a 50% overload than it is under normal operating conditions. Thus, the weighted average horsepower is what is significant. RMS calculations determine the weighted average horsepower.

In addition to reducing the size and cost of a motor for a particular application, RMS loading also offers the advantage of being able to improve the overall efficiency and power factor on a duty cycle type of load. For example, when an oversized motor is operated on a light load, the efficiency is generally fairly low, so working the motor harder (with a higher average horsepower), will generally result in improved overall efficiency and reduced operating cost.

In order to use the RMS method of horsepower determination, the duty cycle has to be spelled out in detail as shown in the following example.

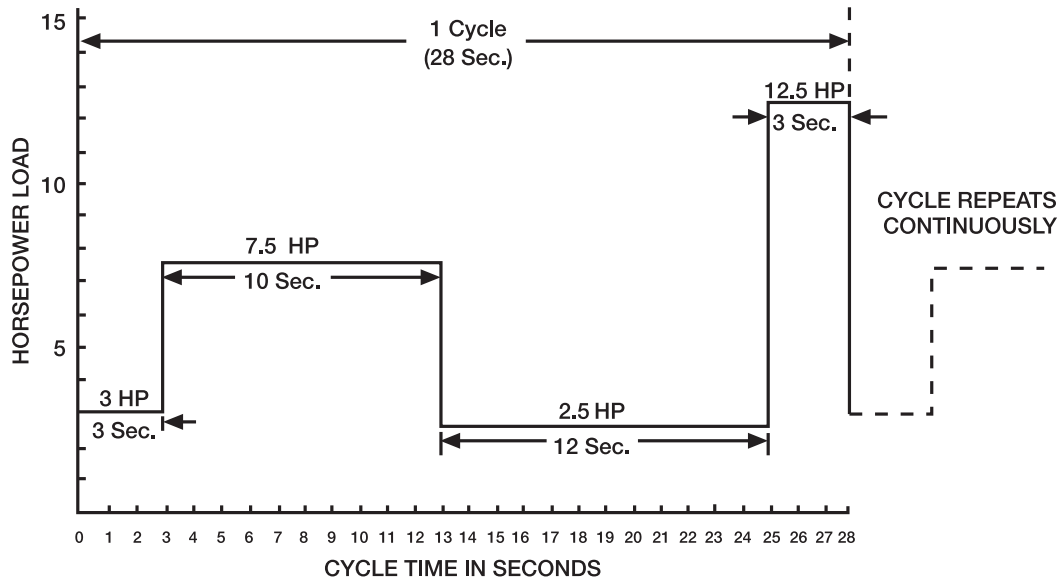

Step	Horsepower	Duration (seconds)
1	3	3
2	7.5	10
3	2.5	12
4	12.5	3

Repeats continuously.

In order to determine the RMS loading for the previous cycle, we can use the formula:

$$\text{RMS HP} = \sqrt{\frac{\text{HP}_1^2 \times t_1 + \text{HP}_2^2 \times t_2 + \text{HP}_3^2 \times t_3 + \text{HP}_4^2 \times t_4 + \dots + \text{HP}_x^2 \times t_x}{t_1 + t_2 + t_3 + t_4 + \dots + t_x}}$$

The easiest way to approach this type of calculation is to make several columns as shown below and fill in the details underneath.

Step	Horsepower	HP <sup>2</sup>	Duration (Seconds)	HP <sup>2</sup> x Time
1	3.0	9.0	3	27.0
2	7.5	56.3	10	563.0
3	2.5	6.3	12	75.6
4	12.5	156.3	<u>3</u>	<u>468.8</u>
			28	1134.4

In this case, the total time of the cycle is 28 seconds and the summation of horsepower squared times time for the individual steps in the cycle is 1134.4. when inserted into the equation, the RMS horsepower comes out to be:

$$\text{RMS HP} = \sqrt{\frac{1134.4}{28}} = \sqrt{40.5} = 6.4$$

At first glance, it appears that a 7-1/2 HP motor would be adequate to handle the loading required by this duty cycle. One further check has to be made and that is to determine if the motor has adequate pullout torque (breakdown torque) to handle the worst portion of the duty cycle without stalling. In this case, you would have to refer to the manufacturer's data for the motor and determine the percent of pullout torque that is available.

An additional safety factor should be used because the pullout torque of the motor varies with the applied voltage. In fact, the pullout torque varies in relation to applied voltage squared. Thus, when the motor is running on 90% of rated voltage the amount of pullout torque available is only .9 x .9 or approximately 80% of the value that it has at full rated voltage. For this reason, it is never safe to use the full value of the pullout torque to determine if the overload can be handled. As a rule of good practice, it is wise not to use more than 80% of the rated pullout for a determination of adequacy.

In this case, referring to the Baldor Engineering Data Section on [www.Baldor.com](http://www.Baldor.com), we would find that a 7-1/2 HP, open drip proof motor with a catalog number M3311T, has a breakdown torque of 88.2 ft. lbs. and a full load operating torque of 22.3 ft. lbs. Thus, the actual pullout torque is 395% and utilizing 80% of this value, we would find that the available, safe pullout torque would be 316%.

For the duty cycle shown, the required pullout torque percentage can be determined by the ratio of maximum horsepower to rated horsepower as follows:

$$\% \text{ Pullout torque required} = \frac{12.5 \text{ (Max. HP Point)}}{7.5 \text{ (Selected HP)}} \times 100 = 167\%$$

Since the available pullout torque at 90% of rated voltage is 316%, this 7-1/2 HP motor would be more than adequate to handle this application.

The previous formula and example can be used for applications where the duty cycle repeats itself continuously, without interruption. When a duty cycle involves a period of shut-off time, a different formula is used. That formula is shown below.

$$\text{RMS HP} = \sqrt{\frac{\text{HP}_1^2 \times t_1 + \text{HP}_2^2 \times t_2 + \text{HP}_3^2 \times t_3 + \dots + \text{HP}_x^2 \times t_x}{t_1 + t_2 + t_3 + \dots + t_x + t_s/C}}$$

where  $t_s$  = number of seconds that motor is stopped

and  $C = 3$  (open drip proof motors)

or  $C = 2$  (totally enclosed motors)

This formula is the same as the previous one but it is modified to reflect the fact that during the non-operating (motor is at standstill) time, it also loses its capability of cooling itself.

The total amount of time for which RMS loading can be adequately calculated would depend somewhat on the size of the motor but, in general, it would be safe to utilize this method for duty cycles that total less than 5 minutes from start to finish (of one complete cycle). If the total time is beyond 5 minutes, then the application should be referred to the motor manufacturer for more detailed analysis.

### SUMMARY

RMS horsepower loading is a very practical way to reduce motor horsepower requirements on cycling loads. With reduced motor horsepower also come a reduction in physical size and a reduction in initial cost, along with somewhat improved efficiency and reduced operating costs. If the selection procedure is handled carefully, you can expect to get very good performance and reliability from the completed unit.

On servomotors and other adjustable speed applications, similar calculations are frequently made. In these cases armature amperes or required torques are substituted in place of horsepower. The resulting RMS amperes or RMS torque requirement is then compared to the motor's continuous and peak ratings to determine adequacy.

If you should have any questions regarding this method of sizing, please feel free to give us a call.



# FACTORS THAT DETERMINE INDUSTRIAL ELECTRIC BILLS

## INTRODUCTION

A good deal of confusion exists regarding the factors that determine an industrial electric bill. The following information is presented to help sort out the various items on which billing is based, and to offer suggestions on measures to help control and reduce electric utility bills.

Three basic factors and an optional item determine an industrial power bill. They are:

- 1 – Kilowatt hour consumption
- 2 – Fuel charge adjustments
- 3 – Kilowatt demand
- 4 – Power factor penalty (if any)

## KILOWATT HOURS

The first of these is the easiest to understand since it is one that we are familiar with based on our experience at home. Kilowatt hour consumption is the measure of the electrical energy that has been used during the billing period, without any regard to when or how it is used. In most cases, it is determined on a monthly basis by taking the accumulated kilowatt hour readings from the dial of a conventional kilowatt hour meter.

## FUEL CHARGE ADJUSTMENT

Fuel charge adjustment is an adjustment factor determined monthly. It is based on the cost of the fuel used to produce power during a given month. For example, in areas where water power is plentiful in the Spring, the contribution of water power might be great and its cost low. Thus, in the Spring of the year, a downward adjustment might be made in fuel cost. In other instances, and at other times of the year, a utility may find it necessary to burn large quantities of high priced imported oil to meet their requirements. When this occurs, there would be an upward adjustment of the fuel cost charge. Fuel charge adjustments are usually based on a unit charge per kilowatt hour.

## KILOWATT DEMAND

Perhaps the least understood factor involved in calculating an industrial electric bill is the matter of demand. Demand is based on how much power is consumed during a given period of time. It is measured in kilowatts and it determines how much equipment the utility has to supply in terms of transformers, wire and generation capability, to meet a customer's maximum requirements. Demand can, in some ways, be compared to the horsepower of an automobile engine. The normal requirement may be relatively low but the size of the engine is determined by how much power is needed to accelerate the car. Similarly, demand reflects a peak requirement. However, the term peak in relation to electric demand is frequently misunderstood. In virtually all cases, demand for an industrial plant is based on a 15 or 30 minute average. Thus, brief high peaks, such as those that are present during the starting of large motors, are averaged because the starting is of very short duration with respect to the demand averaging interval.

A description of how the demand is measured may help to clarify this point. In each demand meter there is a resetting timer. This timer establishes the demand interval and that interval, as mentioned previously, may be either 15 or 30 minutes. In effect, during the demand interval, the total number of revolutions made by the kilowatt hour meter disc is recorded. Thus, a high number of turns during the demand interval would indicate a high demand, and a small total number of turns during the demand interval would indicate a low demand.

For example, when a large motor is started, it would cause the disc in the meter to surge forward for a short period of time. However, as the initial surge passes, the meter would settle down to a normal rotation rate. Thus, the extra disc revolutions recorded as a result of the motor in-rush would not have much impact on the total number of revolutions that accumulate during a 15 or 30 minute interval. At the end of each demand averaging interval, the meter automatically resets and starts recording for the next 15 minute period. This process goes on continuously. A special dial, which can be seen in Figure 1, records only the highest demand since the last time the meter was read. When the monthly reading is taken, the meter reader resets the demand to zero. Once again, the meter starts searching for the highest 15 minute interval and it does so continuously until the next time it is read. It is the highest demand for a month that is normally used to compute the bill. More about this later.

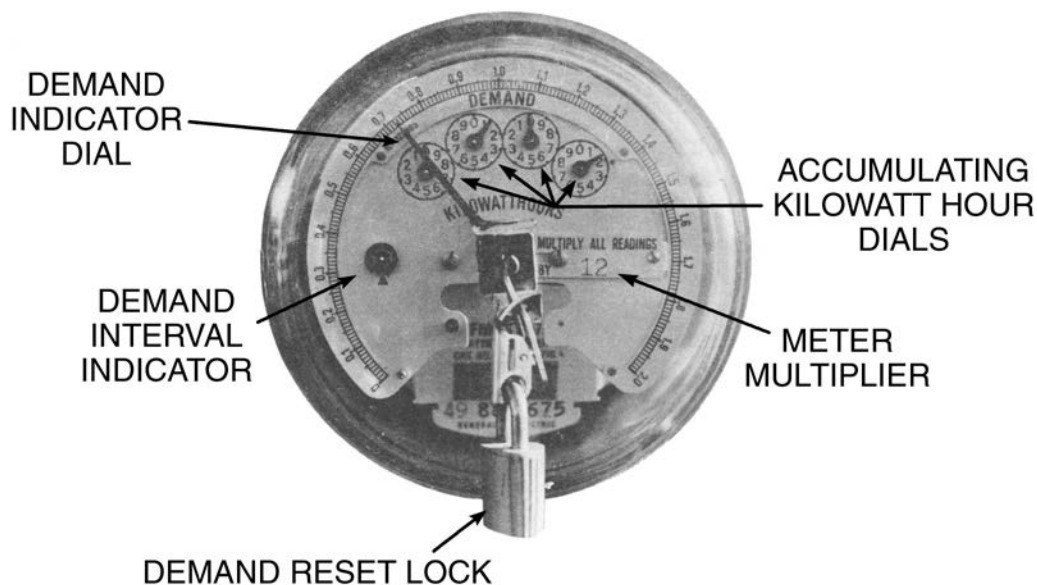

Figure 1

This is a typical demand meter used on a small commercial installation. The demand is determined by reading the position of the top needle and multiplying that reading by the meter constant. In this case, the reading is .725 multiplied by 12 for a demand reading of 8.7 KW. After the monthly reading is taken, the lock is unlocked, the needle reset to zero, and the meter is relocked. Accumulated kilowatt hours are recorded in the conventional manner on the dials.

Figure 2 shows an example of typical manufacturing plants recorded demand over the course of twenty-four hours. This plant had a full first shift and partial second shift. By examining the graph, it is easy to pick out some of the factors influencing the demand. The initial run up of demand occurs as the first shift starts. The growth of demand continues until the preparation for a coffee break begins. Coffee breaks result in a major dip followed by another run up until the peak demand is reached shortly after 10 a.m. Demand then stays reasonably steady until preparations for lunch and the lunch period begins.

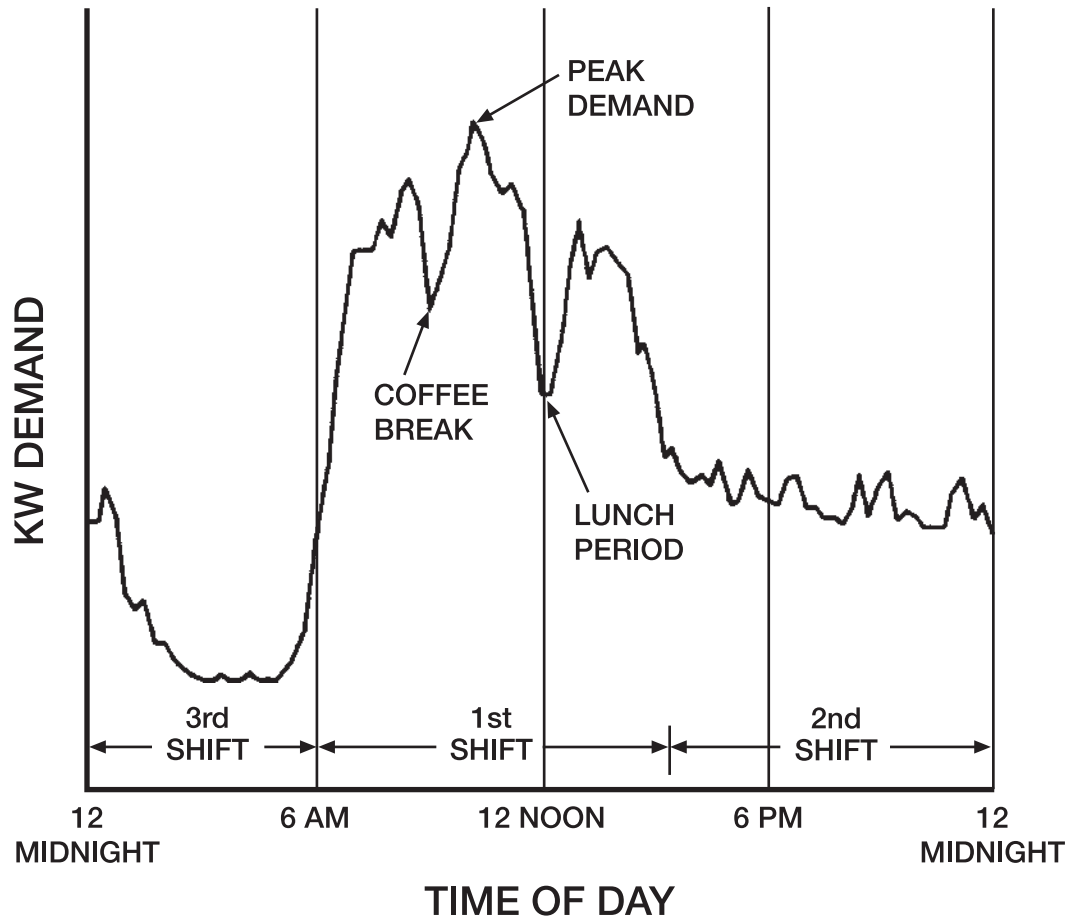

Figure 2

It is interesting to note that after the lunch hour, things never quite get back to equal the peak that occurred before the lunch period. Another lower peak occurs at 1:00 p.m., followed by lower peaks and a final drop-off as clean up and end of shift occurs. The second shift has peaks and valleys similar to the first shift but shows the lower level of activity in the plant. Finally, on the third shift, demand drops sharply to a level reflecting only the very basic loads of security, lighting, and other continuous loads.

### **CONTROLLING DEMAND**

Reducing demand peaks will result in lower demand charges and lower bills. High demand can result from a number of factors. Some of the most likely would be the heating up of large furnaces or ovens during the normal work day. This can happen since the heat-up requirement may be five to six times the sustaining requirement for this equipment. Installing time switches which will allow the unit to preheat to normal operating temperature before the plant shift starts is one easy way to reduce demand peaks. This approach keeps the large demand required by heat-up from being imposed on top of the normal plant demand. Large central air-conditioning chillers can pose similar problems if they are allowed to start during the normal shift rather than pre-cooling the building during a non-working period.

Other factors that can contribute to high demands would be items such as air compressors if start up is delayed until after the normal work shift starts. In this case, the compressor may run at full load for an extended period, until the accumulator and distribution system has been filled. The solution with air compressors is the same as that with industrial ovens. A timer can be used to start the compressors and fill the system prior to the normal shift start. This approach allows the pressure to build up and the compressor to fall into a normal loading and unloading pattern prior to the time that the balance of the plant load is applied.

With some thought, you will be able to discover some items within a facility that may fall into the category that can increase peak demand. The installation of seven day timers that will start essential compressors, ovens and other similar loads ahead of the first shift, can help reduce demand in most plants.

Demand charges are normally figured on a dollars per kilowatt basis. For example, one Connecticut utility has an industrial power rate that charges \$401.00 for the first 100 kilowatts of demand and \$2.20 for each additional kilowatt.

### **DEMAND RATCHETS**

To encourage industrial plants to control their demand to reasonable levels, many utilities impose a twelve month ratchet on demand. What this means is that a very high demand, established in a particular month, will continue to be billed at a percentage of that high demand for eleven months unless actual demand exceeds the established percentage of the previous peak. This type of arrangement can be expensive to the power customers who are not careful in controlling their demand, and to industries having high seasonal variations.

In many situations it is not possible to exercise any great degree of control over plant demand without encumbering operations unnecessarily and adding extra labor costs, etc. Even if a plant happens to be in one of these situations, it is important to understand the basic factors involved in demand and to understand what equipment within a facility is contributing to the total demand picture.

### **DEMAND MONITORING AND CONTROL**

Demand monitoring and control equipment is available to help plant operators control their demand and energy costs. This equipment is based on monitoring the demand build-up over the normal demand averaging interval and taking action to curtail certain loads or operations to level peaks and prevent new peaks from being established. For demand control to be effective, a plant must have electrical loads that can be deferred. Typical examples of deferrable loads would be water heating for storage, heat treating, and possibly the controlled shutdown of certain portions of ventilation systems where short term interruptions would not create a problem.

Demand control is not for everyone but it can save substantial amounts of money when the right conditions exist.

### **POWER FACTOR**

Another misunderstood item in computing industrial electrical bills is power factor penalty. Power factor, in itself, is quite complicated to attempt to deal with in a broad manner. However, a capsule summary might be in order.

Utilities have to size their transformers and distribution equipment based on the amount of amperes that are going to be drawn by the customer. Some of these amperes are borrowed to magnetize inductive loads within the plant. This borrowed power is later returned to the utility company without having been bought. This borrowing and returning goes on at the rate of 60 times a second (the frequency of a 60 cycle power system). The borrowed power, as mentioned previously, is used to magnetize such things as electric motors, transformers, fluorescent light ballasts, and many other kinds of magnetic loads within a plant. In addition to the borrowed power, there is the so-called real power. This is the power that is used to produce heat from heating elements, light from incandescent bulbs, and to drive the shaft on motors. Power factor is a measure of the relative amounts of borrowed versus real power that is being used within the plant.



Obviously, utilities would like to have the situation where the customer borrows nothing and utilizes everything. In commercial and industrial situations, this ideal almost never exists. Plants with large quantities of lightly loaded motors or large quantities of electric welding equipment, may run at poor power factors of 65 to 70%. On the other hand, plants with substantial amounts of electric heating equipment as found in injection molding machines and fully loaded motors, could run with power factors of 85 to 90%.

Plants with poor power factors can improve their situation by adding power factor correction capacitors to their systems. Power companies like to have plants provide power factor correction capacitors since they lessen the number of amperes that need to be supplied. Within an individual plant, higher power factors also mean that incoming circuit breakers and distribution panels are not being taxed as much. So, within the plant, good power factor has some rewards as well.

### **POWER FACTOR PENALTIES**

Some utilities impose power factor penalties. What this means is that when your power factor falls below a pre-established level, a penalty charge may be added to the basic bill for kilowatt hours, fuel charge, and demand. The amount of the penalty is dependent on how far below the pre-established level the power factor falls. There is no uniformity among utilities on how they determine the power factor penalties and at what level they start. The variations in the way they are imposed is almost as large as the number of different utilities in the country. The penalties can range from none at all, which is the case with a great many power companies, to very substantial penalties imposed by others. Frequently, when penalties are imposed, there is also a reward arrangement. The reward is structured to reward high power factor customers by giving them a credit on the monthly bill for having high power factor.

If you are concerned with power factor and any possible penalty you may be paying, the best approach is to contact the local power company. They will provide you with any information you might require on the existing power factor and any penalties that are being paid. They can also help you compute the amount of power factor correction that you may need to eliminate any penalty charges.

### **SUMMARY**

Understanding the four factors that go into determining industrial electric bills can help map approaches to saving money on electric bills. Generally speaking, conservation efforts such as reduced lighting levels, buying more efficient motors, and replacing existing inefficient equipment with equipment having better designs, will reduce both kilowatt hour consumption and kilowatt demand. Reducing kilowatt hour consumption will also reduce fuel charge assessment. Shifting demand of certain types of equipment into more optimum time periods when plant demand is low, can reduce kilowatt demand and the charges associated with it. Finally, improving power factor, if there are penalties being imposed, will help reduce power factor penalty charges.

A basic understanding of these four factors can help the conservation-minded to reduce overall electric energy costs. Table I shows a simplified analysis of how various conservation and load control actions effect the four components that make up the normal industrial electric bill. It can be used as a guide in directing conservation and electric bill reduction.

**CONSERVATION ACTION/RESULTS CHART**

**SAVINGS POSSIBILITY**

<b>EQUIPMENT OR ACTION</b>	<b>ENERGY (KW HRS)</b>	<b>FUEL COST ADJ.</b>	<b>DEMAND KW</b>	<b>POWER FACTOR</b>
REDUCED LIGHT LEVELS	REDUCED	REDUCED	REDUCED	NEGLIGIBLE
MORE EFFICIENT LIGHT SOURCE	REDUCED	REDUCED	REDUCED	NEGLIGIBLE
ENERGY EFFICIENT MOTORS	REDUCED	REDUCED	REDUCED	MODEST IMPROVEMENT
PROPER SIZING OF MOTORS	MODEST REDUCTION	MODEST REDUCTION	MODEST REDUCTION	REASONABLE IMPROVEMENT
DEMAND CONTROL	SLIGHT REDUCTION	SLIGHT REDUCTION	SUBSTANTIAL REDUCTION	NEGLIGIBLE

*Table 1*

# ELECTRIC MOTORS AND POWER SYSTEMS

There seems to be a lot of confusion about the voltage standards for motors and why they are structured the way they are. There are, of course, two broad categories of motors, AC and DC. The voltage standards for these two decidedly different motors are much different from each other. It will be the goal of this paper to try to reduce some of the confusion that exists in the AC motor voltage standards.

## AC POWER SYSTEMS

To understand how voltage standards for motors are set it is important to know the basics of the power systems they operate on. In general, utilities that supply power in the USA, and most other 60 cycle countries, are required to provide power to the incoming point of a facility in multiples of 120 volts. Thus incoming equipment, such as circuit breaker panels, are rated in multiples of 120 volts. The common voltages are 120, 240, 480, and 600.

In addition, utilities are obligated by the regional governing authorities, (usually called Public Utility Commissions) to regulate the voltage within a fairly narrow range such as plus or minus 5%.

For example, in most single phase residential systems the voltage is 120/240. It is brought to the building with 3 wires, one being a neutral and the other two having voltages 120 volts different from the neutral wire. The voltage difference between the two “hot” wires is 240 volts.

In 3 phase systems the situation is a bit different. There are **3 phase, 3 wire, ungrounded systems** where the voltage between the three wires is 240 volts. The big brother of that system is the ungrounded 3 phase, 3 wire 480 volt system. Ungrounded systems are usually found in older facilities.

In newer installations, the two most popular systems are called **4 wire grounded wye systems**. The low voltage version is represented by a 120/208 volt system. The higher voltage version it is a 277/480 volt system. On both of these “grounded wye” systems, the low voltage portion (120 or 277 volts) **is only available as single phase**. The high voltage (208 or 480 volts) is available as either single phase or 3 phase. It should be noted that in the 4 wire grounded wye systems the high voltage is 1.73 times (the square root of 3) higher than the low voltage. These grounded wye systems are generally felt to be safer and more flexible than the older ungrounded systems. The flexibility comes from the ability to handle single phase lighting circuits, that operate at 120 volts or 277 volts, from the same system that feeds the 3 phase circuits for motors, equipment for heating, air conditioning, elevators, and industrial machinery.

## MOTORS

Now to discuss motors that operate on these 60 cycle power systems. In the case of “utilization equipment”, such as motors, the voltage standards have been selected in multiples of 115 volts. For example, 115, 230, 460 and 575 volts. The standards for the “utilization equipment” have been deliberately picked to be slightly less than the utility delivery voltages because in an industrial plant or large commercial building there may be several hundred feet between the incoming service point and the equipment. The distances involved will always lead to some voltage loss (or drop) through the wiring. On short runs this might be very small, even less than a volt, but on long heavily loaded runs it might be as much as 3 or 4% of the operating voltage. So choosing the utilization voltage to be different — and less than — the utility service voltage makes good sense.

There is also another factor that should be mentioned. The design standards for utilization equipment are set so the equipment is able to handle a voltage variation of plus or minus 10% of the nameplate rating. Thus a motor nameplated at 460 volts should be able to be operated successfully up to 460 plus 10% (506 volts) and down to 460 minus 10% (414 volts). If everything is right with the voltage of the system

being in multiples of 120 plus or minus 5% and the equipment voltage being multiples of 115, plus or minus 10% then everything fits together like a neat jigsaw puzzle.

There is one oddity in the mix. That is 3 phase motors for the 120/208 volt power systems. For example, if the power system were to be 208 volts minus 5% (approximately 198 volts) and you were using a 230 volt motor, then the 230 volt motor could only go down to 207 volts (-10%) without being in trouble. There would be a discrepancy between the 198 volt low range of the system voltage, and the 207 lowest operating voltage of a 230 volt motor, this could spell trouble. So how can this be addressed?

There are two ways that motor manufacturers have faced up to the problem. The first is to provide motors rated for 200 volts that can operate successfully down to 180 volts, or up to 220 volts. This is an adequate margin to cover the normal range of voltages that could be expected on a 120/208 volt system. But using this approach exclusively would mean that the complete inventory of motors in all sizes, enclosures, mechanical configurations, etc. would have to be duplicated to handle the motor requirements for the 120/208 volt power systems. This would be very expensive and cumbersome, especially with the wide variety of small motors (under 10 HP) that exist.

So most motor manufacturers have taken a different approach to handling these smaller motors. This approach is that by using a somewhat more conservative design on the 230 volt motors it is possible to create a 3 phase, tri-voltage motor with voltage ratings of 208-230/460. With this approach the 230 volt winding ( and connection diagram) is used on the 208 volt power system. When this approach is taken the motor manufacturer is essentially saying that this motor can be successfully operated on voltages as low as 208 minus 10% or 187 volts. This approach usually works very well since 208 volt power systems are normally used in small buildings with relatively short distances between the incoming power service and the utilization equipment. These short runs tend to make 208 volt power systems quite stable so that the limit of the motor's low voltage capability is seldom tested.

On motors larger than 10 HP the 200 volt motor is generally the best choice, but in many situations 230 volt motors are frequently and successfully applied on the 208 volt systems. In some cases a derate table is provided for the "low voltage" situation. In other cases the motor service factor may be reduced from 1.15 down to 1.0 when it is applied to a 208 volt power system.

Table 1 summarizes this information to show the power system voltage and description along with the motor voltage rating for single and 3-phase 60 Hertz motors.

## **50 HERTZ POWER SYSTEMS**

There seems to be an endless array of possible combinations, but most of them do make sense. In 50 hertz areas virtually all power systems are of the 4 wire, grounded wye type. A typical arrangement would be a 220/380 volt power system. In this case, as in the case of a 120/208 volt 60 hertz system, the (low voltage) 220 volt power is only available as single phase and the 380 volt power is available as either single or three phase.

As a result of the voltage being described as 220/380 we frequently see specifications indicating that 3-phase motors be wound for 220/380. Although feasible to do this, it is unnecessary because the 3-phase motors will only be operated on 380 volt 3-phase power.

Some of the most popular voltages are 220/380 and 240/415. Recently European countries have recognized the problem of trying to provide equipment for these two different voltage standards and have come up with a standard that splits the difference. The new standard is 230/400. What this means is that if the motor has an adequate amount of tolerance it can run on either a 380 volt system or a 415 volt system without being damaged. Also in most 50 Hertz systems, unlike the domestic systems, the equipment voltage rating tends to be the same as the supply voltage. In other words, 380 volt motors are used on 380 volt systems as opposed to situation in this country where the equipment utilization voltage is deliberately set lower than the supply voltage.

Table 2 shows some typical supply voltages and the appropriate equipment standards for 50 cycle power systems.

When dealing with foreign voltage requirements it is always desirable to check the specified voltage against the listing of available voltages indicated in a U. S. Department of commerce booklet, ***Electric Current Abroad***. If the specified voltage and frequency **does not match** the voltages shown in the booklet for the **country** and **city** involved it should be a “Red Flag” that would suggest that the customer be contacted and the voltage confirmed for accuracy. Mistakes can be very costly!!

**TABLE 1**

TYPICAL 60 HZ COMMERCIAL AND INDUSTRIAL POWER SYSTEM VOLTAGES				
SUPPLY VOLTAGE	SYSTEM CONFIGURATION*	UTILIZATION EQUIPMENT VOLTAGE RATINGS		CLASSIFICATION
		SINGLE PHASE	3 PHASE	
120/208	3 Phase 4 Wire Grounded Wye (A)	115 208 - 230	200 208 - 230	Low Voltage
240	3 Phase 3 Wire Delta Connected (B) (Normally Ungrounded) (1)	230 208 - 230	230 208 - 230	
120/240/240	3 Phase 4 Wire Tapped Delta (C) Neutral Grounded	115 230 208 - 230	230 208 - 230	
277/480	3 Phase 4 Wire Grounded Wye (A)	277 265 (2)	460	
480	3 Phase 3 Wire Delta Connected (B) (Normally Ungrounded) (1)	460	460	
600	3 Phase 3 Wire Delta Connected (B) (Normally Ungrounded) (1)	575	575	
2400	3 Phase 3 Wire Delta Connected (B)	2300	2300 2300/4160	Medium Voltage
4160	3 Phase 4 Wire Grounded Wye (A)	2300 4000 4160	4000 2300/4160	

(1) On some systems grounding of one leg may be utilized.  
(2) Some Single Phase equipment may be rated for 265 Volts.

\*See page 58 for typical transformer connections.

**TABLE 2**

TYPICAL 50 HZ COMMERCIAL AND INDUSTRIAL POWER SYSTEM VOLTAGES			
SUPPLY VOLTAGE	SYSTEM CONFIGURATION*	UTILIZATION EQUIPMENT VOLTAGE RATINGS	
		SINGLE PHASE	3 PHASE
115/200	3 Phase 4 Wire Grounded Wye (A)	115 200	200
127/220	3 Phase 4 Wire Grounded Wye (A)	127 220	220
220/380	3 Phase 4 Wire Grounded Wye (A)	220 380	380 400 (1)
230/400	3 Phase 4 Wire Grounded Wye (A)	230 400	400
240/415	3 Phase 4 Wire Grounded Wye (A)	240 415	415 400 (1)
250/440	3 Phase 4 Wire Grounded Wye (A)	250 440	440
220	3 Phase 3 Wire Delta Connected (B)	220	220
440	3 Phase 3 Wire Delta Connected (B)	440	440
(1) Alternate Rating			

\*See page 58 for typical transformer connections.

### **SUMMARY**

Matching motors to the power system voltages can be fairly simple if the basis of the systems is understood.

# Typical 3 Phase Transformer Connections

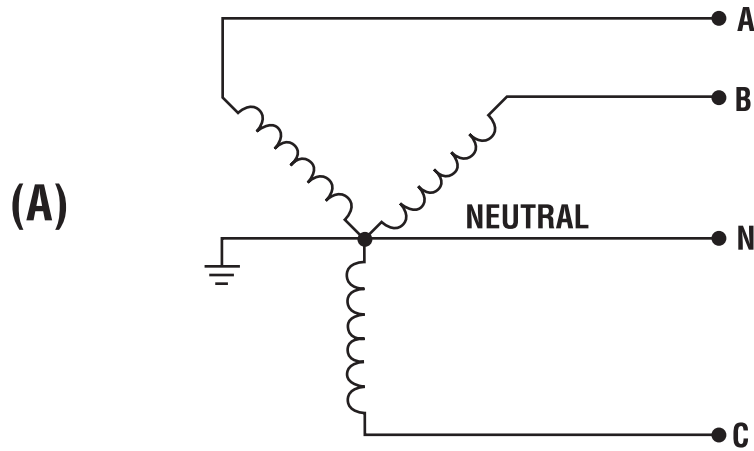

**4 Wire  
Grounded Wye**

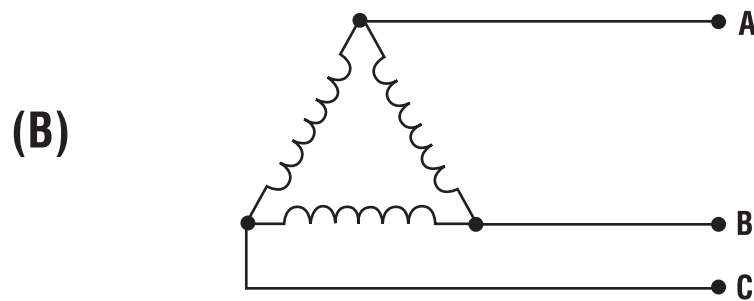

**3 Wire  
Ungrounded Delta**

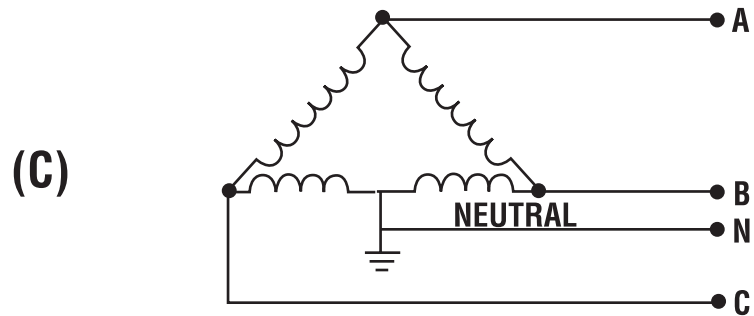

**4 Wire Tapped  
Delta  
Neutral Grounded**



# ELECTRIC MOTORS AND VOLTAGE

The effect of low voltage on electric motors is pretty widely known and understood but, the effect of high voltage on motors is frequently misunderstood. This paper will try to describe the effects of both low and high voltage and to describe the related performance changes that can be expected when voltages other than nameplate voltages are utilized.

## LOW VOLTAGE

When electric motors are subjected to voltages, below the nameplate rating, some of the characteristics will change slightly and others will change more dramatically. A basic point is, to drive a fixed mechanical load connected to the shaft, a motor must draw a fixed amount of power from the power line. The amount of power the motor draws is roughly related to the voltage times current (amps). Thus, when voltage gets low, the current must get higher to provide the same amount of power. The fact that current gets higher is not alarming unless it exceeds the nameplate current rating of the motor. When amps go above the nameplate rating, it is safe to assume that the buildup of heat within the motor will become damaging if it is left unchecked. If a motor is lightly loaded and the voltage drops, the current will increase in roughly the same proportion that the voltage decreases.

For example, a 10% voltage decrease would cause a 10% amperage increase. This would not be damaging if the motor current stays below the nameplate value. However, if a motor is heavily loaded and a voltage reduction occurs, the current would go up from a fairly high value to a new value which might be in excess of the full load rated amps. This could be damaging. It can be safely said that low voltage in itself is not a problem unless the motor amperage is pushed beyond the nameplate rating.

Aside from the possibility of over-temperature and shortened life created by low voltage, some other important items need to be understood. The first is that the starting torque, pull-up torque, and pull-out torque of induction motors, all change based on the applied voltage squared. Thus, a 10% reduction from nameplate voltage (100% to 90%, 230 volts to 207 volts) would reduce the starting torque, pull-up torque, and pull-out torque by a factor of  $.9 \times .9$ . The resulting values would be 81% of the full voltage values. At 80% voltage, the result would be  $.8 \times .8$ , or a value of 64% of the full voltage value.

In this case, it is easy to see why it would be difficult to start "hard-to-start" loads if the voltage happens to be low. Similarly the motor's pull-out torque would be much lower than it would be under normal voltage conditions.

To summarize the situation, low voltage can cause high currents and overheating which will subsequently shorten motor life. Low voltage can also reduce the motor's ability to get started and its values of pull-up and pull-out torque. On lightly loaded motors with easy-to-start loads, reducing the voltage will not have any appreciable effect except that it might help reduce the light load losses and improve the efficiency under this condition. This is the principle that is used in the so-called Nola devices that have been sold as efficiency improving add-on equipment to motors.

## EFFECTS OF HIGH VOLTAGE

One thing that people assume is, since low voltage increases the amperage draw on motors, then by the same reasoning, high voltage would tend to reduce the amperage draw and heating of the motor. This is not the case. High voltage on a motor tends to push the magnetic portion of the motor into saturation. This causes the motor to draw excessive current in an effort to magnetize the iron beyond the point to which it can easily be magnetized. This generally means that the motors will tolerate a certain change in voltage above the design voltage but extremes above the designed voltage will cause the amperage to go up with a corresponding increase in heating and a shortening of motor life. For example, older motors

were rated at 220/440 and had a tolerance band of plus/minus 10%. Thus, the voltage range that they can tolerate on the high voltage connections would be 396 to 484. Even though this is the so-called tolerance band, the best performance would occur at the rated voltage. The extreme ends, either high or low, would be putting unnecessary stress on the motor.

Generally speaking, these tolerance bands are in existence not to set a standard that can be used all the time but rather to set a range that can be used to accommodate the normal hour-to-hour swings in plant voltage. Operation on a continuous basis at either the high extreme or the low extreme will shorten the life of the motor.

Although this paper covers the effects of high and low voltage on motors, the operation of other magnetic devices are effected in similar ways. Solenoids and coils used in relays and starters are punished by high voltage more than they are by low voltage. This is also true of ballasts in fluorescent, mercury, and high pressure sodium light fixtures. Transformers of all types, including welding transformers, are punished in the same way. Incandescent lights are especially susceptible to high voltage conditions. A 5% increase in voltage results in a 50% reduction in bulb life. A 10% increase in voltage above the rating reduces incandescent bulb life by 70%.

Overall, it is definitely in the equipment's best interest to have the utility company change the taps on incoming transformers to optimize the voltage on the plant floor to something that is very close to the equipment ratings. In older plants, some compromises may have to be made because of the differences in the standards on old motors (220/440) and the newer "T" frame standards (230/460), but a voltage in the middle of these two voltages, something like 225 or 450 volts, will generally result in the best overall performance. High voltage will always tend to reduce power factor and increase the losses in the system which results in higher operating costs for the equipment and the system.

### EFFECT OF VOLTAGE VARIATION ON "T" FRAME MOTORS

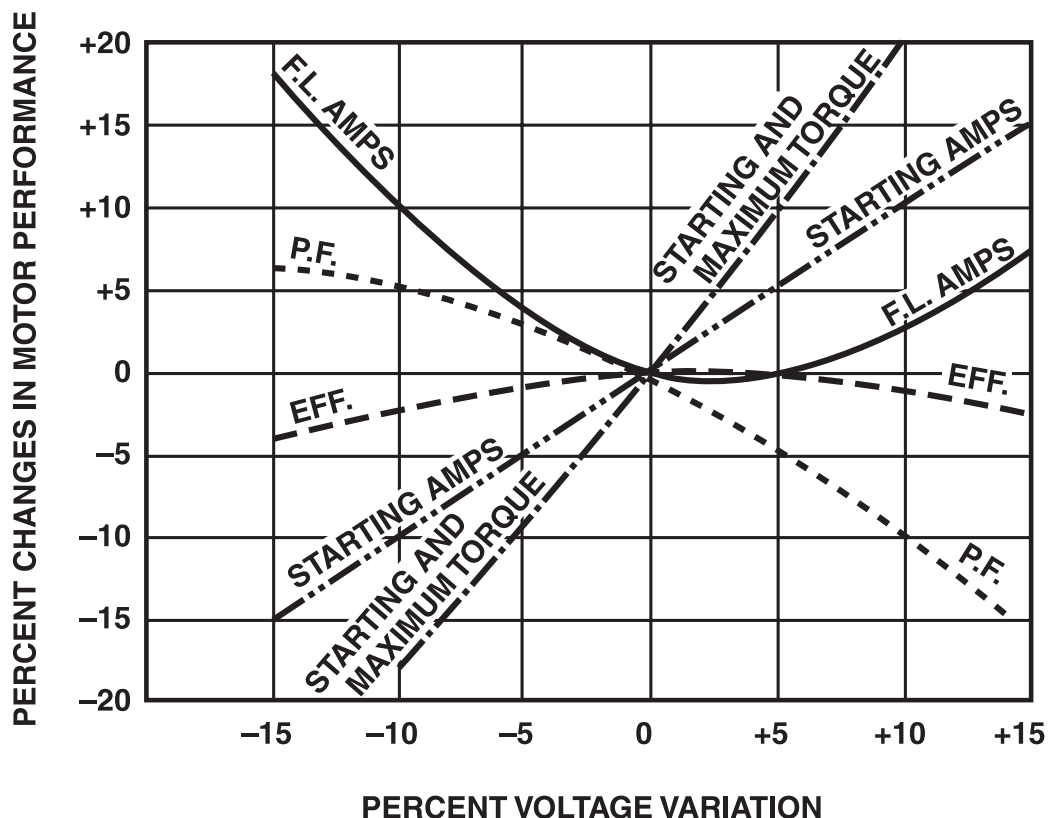

Figure 1

The graph shown in Figure 1 is widely used to illustrate the general effects of high and low voltage on the performance of “T” frame motors. It is okay to use the graph to show “general” effects but, bear in mind that it represents only a single motor and there is a great deal of variation from one motor design to the next.

For example, the lowest point on the full load amp line does not always occur at 2-1/2% above rated voltage. On some motors it might occur at a point below rated voltage. Also the rise in full load amps at voltages above rated, tends to be steeper for some motor winding designs than others.

Some general guidelines might be useful.

1. Small motors tend to be more sensitive to over-voltage and saturation than large motors.
2. Single phase motors tend to be more sensitive to over-voltage than three phase motors.
3. U-frame motors are less sensitive to over-voltage than “T” frames.
4. Premium efficiency Super-E motors are less sensitive to over-voltage than standard efficiency motors.
5. Two pole and four pole motors tend to be less sensitive to high voltage than six pole and eight pole designs.
6. Over-voltage can drive up amperage and temperature even on lightly loaded motors. Thus, motor life can be shortened by high voltage.
7. Full load efficiency drops with either high or low voltage.
8. Power factor improves with lower voltage and drops sharply with high voltage.
9. Inrush current goes up with higher voltage.

## **SUMMARY**

There are very few desirable and many undesirable things that happen to electric motors and other electrical equipment as a result of operating a power system at or near the ends of voltage limits. The best life and most efficient operation usually occurs when motors are operated at voltages close to the nameplate ratings.



# UNBALANCED CURRENTS

Motor users and installers get concerned when they detect unbalanced phase currents on a 3-phase motor. The question is frequently asked: “Is there something wrong with the motor?” The other question is: “How much current unbalance can be tolerated?” This paper will attempt to answer those questions.

## HISTORY

In the “Good Old Days” about the only sources of unbalanced phase currents was either a problem in the motor, such as an unbalanced number of turns in the windings, an uneven air gap or unbalanced phase voltages. Winding or air gap problems are definitely motor related. On the other hand unbalanced phase voltages are a power system problem. Unbalanced voltages will generally produce unbalanced currents that are many times greater than the percentage of voltage unbalance. The ratio used is close to 8:1. In other words, a voltage unbalance of 1% could create unbalanced phase currents of as much as 8%.

A very unscientific way of looking at the problem is as follows: Suppose a motor has a nameplate full load current of 10 amps. At full load the amps on each leg of the 3 phases added together would be 10 + 10 + 10 or 30. However, if the load is the same but the phase currents are unbalanced, the total of the 3 legs added together will always be more than the total of the balanced currents. In this case the currents might be 10.5, 11.3 and 12.1 for a total of 33.9. This is a very unscientific way of looking at it, but it is accurate in describing the effect. What this means is that high current on one leg doesn't mean that the other two legs will be reduced by an equal amount. It can be said that unbalanced currents always result in higher operating temperature, shortened motor life and efficiency reduction.

The next question is “What creates unbalanced currents?” In years past, if the motor was not the problem — the source of unbalanced currents was unbalanced phase voltages. When measuring line to line voltages from phase A to B, B to C, and C to A, detectable differences in the voltages would show up. The voltage differences would account for the unbalanced currents.

In today's world there are other problems that are frequently not detectable with simple voltage tests. One problem of growing concern, is voltage distortion caused by harmonics in the power system currents. This can happen if there are loads in the general area that draw non-linear (harmonic rich) currents from the power system, they can create voltage distortion in the normal voltage sine-wave that, in turn, can cause unbalanced currents in motors even when phase voltage differences are not detectable with a voltmeter. For example, if you were to detect unbalanced motor currents and took measurements with a digital voltmeter on the three phases, they might be very close to one another. The natural tendency under these conditions, would be to blame the motor for the problem. When this happens it is necessary to go a step further to identify or dismiss the motor as the source of the problem. The test is to rotate all 3 phases. If the power phases are labeled A, B and C and the motor leads connected to them are labeled 1, 2, and 3, motor lead #1 might be reconnected to power supply lead B; motor lead #2 would be reconnected to power supply lead C, motor lead #3 would be reconnected to power supply lead A. Moving all three legs will keep the motor rotating in the same direction. The currents are recorded on each power line leg before and after the connections are changed. If the high current leg stays with the power line phase (for example, B), then the problem is a power supply problem rather than a motor problem. If, however, it moves with the motor leg, then it is a motor problem. This test will pinpoint the problem to be either power supply or motor.

## HOW MUCH UNBALANCE CAN BE TOLERATED?

In general, this depends on the conditions that are found. If the motor is driving the load and the highest amperage of the three legs is below the nameplate Full Load rating, then generally it is safe to operate. If the high leg is above the nameplate rating, but within the normal service factor amps (for a motor with a service factor, normally 1.15) then it is probably still safe to operate the motor. Also, it is not unusual to find currents more unbalanced at no load than they will be under load, so the loaded amps should

be used. Finally, in general, if the high leg is not more than 10% above the average of the three legs, determined as shown in the example, it is probably safe to operate the motor.

**EXAMPLE**

Motor Nameplate FLA = 10.0

Service Factor 1.15

<u>Phase</u>	<u>Loaded Amps</u>
A	10.6
B	9.8
C	10.2

Determine the Average

$$\frac{10.6 + 9.8 + 10.2}{3} = 10.2 \text{ amps}$$

Determine the % Difference

$$\frac{\text{Highest Phase} - \text{Average}}{\text{Average}} \times 100$$

$$\frac{10.6 - 10.2}{10.2} \times 100 = \frac{.4}{10.2} \times 100 = .039 \times 100 = 3.9\%$$

The following table shows some of the sources of unbalanced voltages and currents along with possible remedies.

<b>TABLE 1</b>	
<b>PROBLEM</b>	<b>SOLUTION</b>
Blown fuse on a power factor correction capacitor bank	Search, find and replace blown fuse.
Uneven single phase loading of the 3 phase system	Locate single phase loads and distribute them more evenly on the 3 phase circuit.
Utility unbalanced voltages	If the incoming voltages are substantially unbalanced, especially at lightly loaded or no load periods, contact the utility company and ask them to correct the problem.
Harmonic distortion	Locate the sources of the harmonics and use harmonic filters to control or reduce harmonics. Install line reactors on existing and new variable frequency controls.

**SUMMARY**

Unbalanced currents on 3 phase motors are undesirable but a small amount can generally be tolerated. Excessive unbalanced currents can shorten motor life and increase energy consumption.



World Energy Engineering Congress

**CONSERVING WITH  
PREMIUM EFFICIENCY MOTORS**

# CONSERVING WITH PREMIUM EFFICIENCY MOTORS

Edward H. Cowern, P.E.

# BALDOR

A MEMBER OF THE ABB GROUP

Wallingford, CT

## INTRODUCTION

Conservation through lighting alterations using different bulbs, ballasts and light sources is well understood and easy to achieve. The use of improved efficiency three phase induction motors has not been as accepted. There are a number of reasons why conservation efforts with motors have not been as popular.

Light bulbs are sold by input ratings or watts. With the input rating being so prominent, it's easy to understand that if a 40 watt bulb is replaced by a 34 watt bulb, there will be savings. But, unlike light bulbs, electric motors are sold by output rating (horsepower) rather than input wattage. As a result, the measure used to evaluate differences in motors is the efficiency rating and efficiency shows up in the fine print and is not as easily understood as the wattage of bulbs.

The second reason lighting is different from motors is that lights are usually on or off – not in between. But motors can be running at full load, half load, quarter load, or no load. Frequently when motors are coupled through clutches to an intermittent motion system the motor may spend a lot of the time operating with no load. Similarly, air compressors may run unloaded much of the time. As a result of varying load levels and intermittent loading, projected savings based on full load efficiencies may not materialize.

That's the bad news.

The good news is that premium efficiency motors, with their enhanced designs, result in lower operating costs at any level of loading including no load. For example, the no load losses of a five horsepower premium efficiency motor might be 215 watts. The no load losses of a standard motor of the same type might be 330 watts. Figure 1 shows a plot of watts loss for various load levels on a conventional motor versus the premium efficiency motor of the

same type. Curves of this type change dramatically with motor size, but trends are the same.

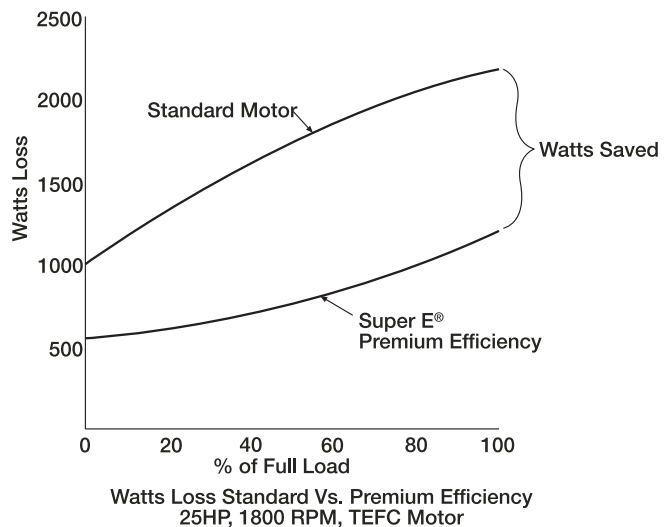

Figure 1

## THE BASICS

The process of converting electrical energy to mechanical energy is never perfect. As much as we would like to have a 100% efficient motor, it is impossible to build a machine that will take 746 watts of electricity (the equivalent of 1 HP) and convert it to 1 HP of mechanical output. It always takes somewhat more than 746 watts to yield 1 HP's worth of output. It does become easier to approach 100% perfection with large motors than with small. For example, if the conversion process were only 50% efficient, then it would take 1492 watts of electricity to get 1 HP's worth of output. Luckily, in industrial motors the conversion process is usually more efficient than this. The efficiency of standard industrial three phase motors usually runs from a level of approximately 75% at 1 HP up to 94% at 200 HP. The curve shown in Figure 2 illustrates the general trend of motor efficiency versus motor size for standard and premium efficiency motors.



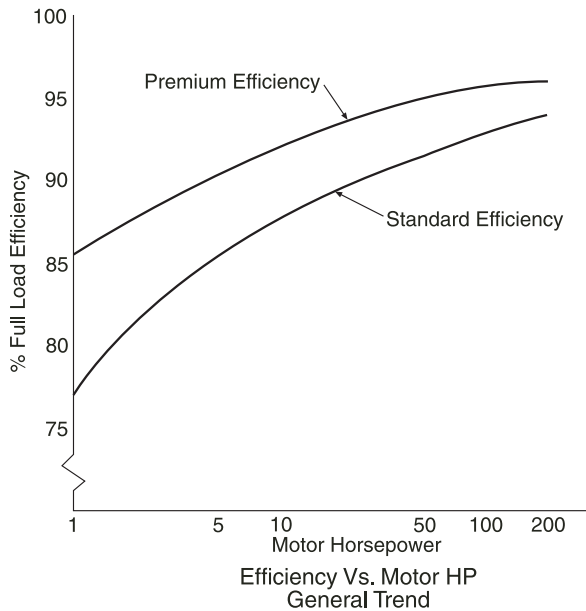

Figure 2

A reasonable question might be, “Where does the extra energy go?” In all cases, energy not delivered to the shaft becomes heat that must be carried away from the outside surface and internal parts of the motor.

As an additional complication, the efficiency of electric motors varies depending on the amount of load on the motor. Figure 3 shows the general trend of motor efficiency based on motor loading.

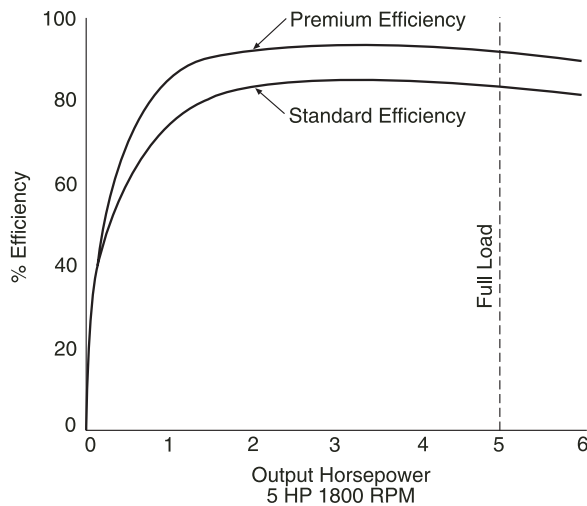

Figure 3

For example, when a motor is running idle (no load on the output shaft), energy is being used by the motor to excite the magnetic field and overcome the friction of the bearings and the so-called windage of the rotating portion of the motor. Thus the efficiency at no load is 0%. The efficiency climbs as torque is applied to the motor shaft up to the point

where the efficiency levels out and ultimately drops from its highest level. In most motors the peak efficiency will occur somewhere between 50 and 100% of rated load. The point at which it peaks is determined by the specific motor design.

To show where the losses occur in a fully loaded motor, Figure 4 gives a general outline of the flow of power through the motor. The flow is shown as 100% electrical power going to the motor on the left side and the various losses involved in converting the power until it ends up as mechanical power at the output shaft. In this case, the major losses are stator resistance loss (so-called Stator  $I^2R$ ). This is the largest single loss in the motor. It is followed by rotor resistance loss (Rotor  $I^2R$ ). Next come losses that are described as the core losses. These are losses resulting from the cycling magnetic forces within the motor. The more specific terms used for these losses are hysteresis and eddy current losses. Hysteresis loss is a result of the constant re-orientation of the magnetic field within the motor’s steel laminations. Eddy current losses occur because the re-orientation of magnetic forces within the steel produces small electrical currents in the steel. These electric currents circulate on themselves and produce heat without contributing to the output of the motor. Hysteresis and eddy current losses occur in both the stationary and the rotating portion of the motor, but the largest share occur in the stationary portion.

**15 HP, 4 POLE, 3 PHASE MOTOR  
TYPICAL ENERGY FLOW**

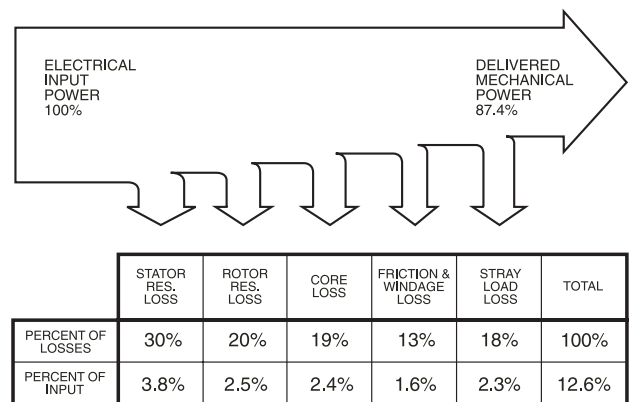

Figure 4

Next come the so called friction and windage losses. In this case the friction is the friction of the bearings. Ball bearings are extremely efficient, but still there are some losses generated as a result of the rolling of the ball bearings. Windage loss is a combination

of things. First, the rotor spinning in the air creates some drag. The faster it spins, the more drag it creates with the surrounding air. In addition, there has to be air flow through or over the motor to carry away heat being generated by the losses. In most cases, a fan is either incorporated on the shaft of the motor or designed in to the ends of the motor's rotor to provide air flow for cooling. This requires energy and uses input without developing output.

Finally, there is a category called stray load losses. These are losses that cannot be accounted for in the previous four categories. Generally, stray load losses are dependent on motor loading and increase as load is applied.

The accepted domestic test for electric motor efficiency is the one defined by IEEE Standard 112 Method B. This test method accounts for all of these losses when the motor's performance is measured on a dynamometer. More about this later.

The energy flow diagram shown in Figure 4 would be typical for a standard motor of 15 HP. The mix of losses will vary somewhat based on motor size, but the diagram shows the overall trend of where the energy goes. It is important to note that many of the core losses and friction and windage losses are independent of the amount of load on the motor, whereas stator resistance loss, rotor resistance loss and stray load losses get larger as torque is applied to the motor shaft. It is the combination of these losses that produces the result of efficiency versus load shown in Figure 5.

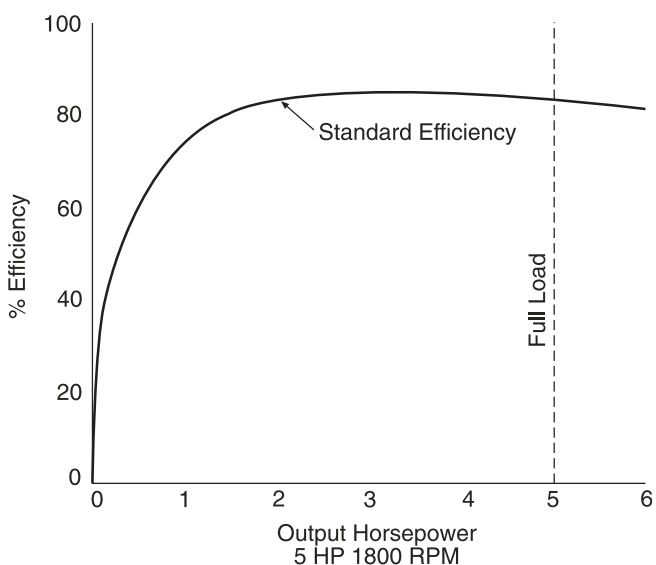

Figure 5

## EFFICIENCY IMPROVEMENT

To improve efficiency of a motor the five categories of losses mentioned previously are worked on one at a time. Reducing the stator resistance loss involves both magnetic and electric modifications that allow for more copper wire to be inserted in the slots of the stator of the motor. In general, the stator lamination design has to have slots large enough to accept more copper wire. For example, in household wiring #12 gauge wire has higher ampacity than #14 gauge wire. The same is the case in motors. But increasing the wire's size without increasing the amperage load results in less loss. In addition, the best reasonably priced conductor material must be used. In the case of electric motors, the best reasonably priced conductor material is copper.

The second largest loss, rotor resistance, is reduced by using special rotor designs with larger areas of aluminum conductor. Using larger "rotor bars" results in lower rotor resistance and less rotor energy loss.

Hysteresis and eddy currents are reduced in many different ways. Hysteresis loss can be reduced by using improved steels and by reducing the intensity of the magnetic field. Eddy current losses are lowered by making the individual laminations that comprise the stator (and rotor) thinner and insulating them more effectively from each other.

In the case of friction and windage, there is little that can be done to improve the efficiency of bearings, but if the previously outlined steps have been effective in reducing total losses, the size of the cooling fan can be reduced which helps increase motor efficiency.

The last component of losses is stray load loss. In this case, various manufacturing techniques are used to reduce stray load losses. With each of the five elements being worked individually and collectively, substantial improvements in motor efficiencies can be achieved.

## BASIS OF COMPARISON

There are many different terms used to compare efficiencies of one motor to another. The two most often heard are nominal efficiency and guaranteed minimum efficiency. It is easy to get confused as to what basis should be used for determining potential savings from efficiency upgrades. The basis for nominal efficiency ratings can be explained in the following manner. If a large batch of identical motors were to be made and tested, the nominal efficiency would be the average efficiency of the batch. Due to manufacturing tolerances, some units might be less efficient and others more efficient. However, the nominal is the predictable average of the lot.

The second term used is guaranteed minimum efficiency. The guaranteed minimum recognizes the variations from one motor to the next and sets an arbitrary low limit. It says in essence, none of the motors in the batch will be less efficient than this.

With these two choices, what should be the basis of comparison?

If you had to stake your life on the result and it involved a single motor, then guaranteed minimum efficiency would be the one to use. However, if you're considering a number of motors in a range of sizes, and you're not held precisely to what the final minimum result would be, then nominal efficiency is the proper basis of comparison. Nominal efficiency also makes it easier because nominal efficiency is stamped on the nameplate of the motor. In addition, nominal and minimum guaranteed are related to each other by a formula established by the National Electrical Manufacturers Association. So comparing different motors on the basis of "nominal" is really equivalent to comparing on the basis of minimum guaranteed.

Of more importance is the standard by which the efficiency is going to be determined. The standard should always be IEEE 112 Method B. Of all standards developed for determining efficiency of motors, this is one of the most rigorous.

Other standards that are used, particularly some international standards, do not demand such rigorous testing. In some cases, efficiency is merely calculated rather than measured. In virtually all cases the "other" standards will give efficiencies higher than the tougher IEEE 112 standard. The correct basis of comparison should be that all motors be compared on the same standard. The

IEEE method also measures the efficiency in the hot running condition. This makes it more accurate because the efficiency of the motor will fall slightly as operating temperature rises.

## A FEW PRECAUTIONS

The result of using premium efficiency motors is not necessarily without some pitfalls. For example, premium efficiency motors run somewhat faster (have less slip) than their less efficient counterparts. A premium efficiency motor might run at a full load speed of 1760 RPM. The motor it replaces might be running at 1740 RPM. This can help or hurt conservation efforts depending on the type of load the motor is driving. For example, if it is driving a conveyor handling bulk materials, the higher speed will result in getting the job done faster. Also, if the conveyor has periods of light load, the reduced losses of the motor will save energy during that period of time.

The same situation exists on many pumping applications where a specific amount of fluid is going to be used to fill a tank. If the motor runs faster, the work is completed sooner and the motor is shut down earlier. In these cases the consequence of the increased speed does not result in increased energy use. But there are applications such as chilled water circulating pumps where the extra speed can reduce expected savings.

The reason this can happen is that centrifugal pumps along with other types of variable torque loads such as blowers and fans, require horsepower proportional to speed cubed. As a result a slight increase in speed can result in a sharper increase in horsepower and energy used. A typical example might be where the original motor is directly connected to a centrifugal pump. The original motor's full load speed is 1740 RPM. The replacement premium efficiency motor, driving the same pump, has a higher speed of 1757 RPM. The resulting difference of 1% will increase the horsepower required by the pump by  $1.01 \times 1.01 \times 1.01 = 1.03$ . Thus the horsepower required by the load is increased by 3% above what it would be if the pump speed had remained the same. Even with increased speed there remains, in most cases, some improvement in efficiency and reduction in energy usage although it may not be what you hoped to achieve.

On fans and blowers the same thing would hold true if no changes take place to bring the equipment speed back to the original value. For example, if a motor drives a fan with a belt drive and the fan speed is 650 RPM, changing the motor and using the same exact pulley and belt would increase the fan's speed and the horsepower required. This could reflect back as extra energy drawn from the power system. However, if an adjustment is made in the ratio between the pulleys to restore the fan speed to the original value, then the anticipated savings will materialize. These types of challenges make it desirable to look at efficiency upgrading as a "system" rather than strictly a motor consideration.

### DRIVEN EQUIPMENT EFFICIENCY

As consumers, we are faced with energy efficient ratings on new refrigerators, air conditioners, hot water heaters, etc. The same type of data is usually not nearly as available on machinery purchased for industrial and commercial installations. For example, not all pumps with the same performance specifications have the same efficiency. Similarly not all air compressors have the same efficiencies. Some air compressors have dramatically better efficiencies than others especially when operated at less than full load. At first glance it looks like a problem of evaluating one versus the other could be insurmountable. However, a good vendor should be willing to share certified performance information.

### PROPER SIZING

In addition to the challenge of different efficiencies from different equipment manufacturers there is also the matter of selecting properly sized equipment. For example, a pump oversized for the job may be much less efficient than a pump properly sized. Similarly, an air compressor oversized for the job may be much less efficient than one selected to more closely match actual requirements.

### EVALUATION

There are a great many ways to approach capital investment and determine rates of return, payback periods, present worth, etc. Most of these are good for large capital investments where there may be risk involved if the project doesn't work out or if the product changes or is affected by market dynamics. Electric motors and other conservation measures

tend to be a simpler problem and usually do not need the rigorous mathematical treatment found in these more complicated analysis approaches. Formulas to determine savings are found in the appendix of this paper.

### IDEAL MOTOR LOADING

In the process of upgrading efficiency a question comes up as to what the ideal load conditions should be for replacement motors. A motor that is overloaded will have short life. In the opposite situation, a motor that is grossly oversized for the job it is asked to do, is inefficient. Figure 6 shows a typical load versus efficiency curve for a 10 HP motor. This curve shows that in the upper half of the load range (50% - 100%) the efficiency stays fairly constant at a high level. At loads below 50% the efficiency drops dramatically. In most situations, once the motor is in operation and running, the load doesn't vary. This is especially true on heating, ventilating and air conditioning applications such as circulator pumps and air handling equipment. On other types of machinery such as air compressors and machine tools, the load may cycle on and off, heavily loaded for some periods and lightly loaded at other times. Obviously on cycling loads it is important to size the motor so that it can handle the worst case condition. However, on continuously loaded motors it is desirable to load motors at somewhere between 50 and 100% and more ideally in the range of 75 to 80%. By selecting a motor to be loaded in this range, high efficiency is available and motor life will be long. Also, by loading at somewhat less than 100% the motors can more easily tolerate such things as low voltage and high ambient temperatures that can occur simultaneously in summer. This approach will get somewhere closer to optimum efficiency while preserving motor life.

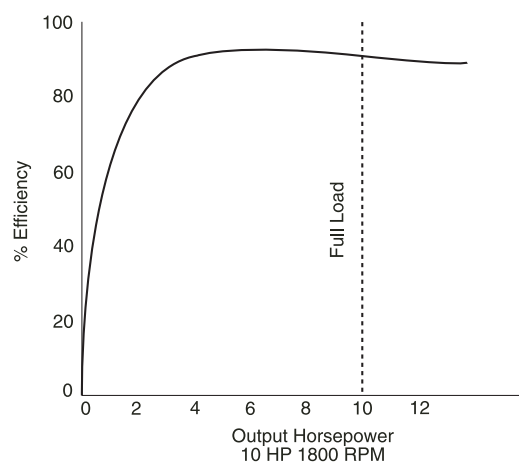

Figure 6

## EXISTING MOTOR EFFICIENCY UPGRADES

In a commercial or large industrial situation the question comes up: "Should motors be replaced on a wholesale basis throughout the plant or selectively changed?" There is probably no hard rule for this, but here are some ideas. The wholesale change-out of all motors in a plant or commercial building generally cannot be justified on a cost basis. The reason for this is that some of the motors may be used only intermittently. Such things as test equipment, trash compactors and other similar situations support the case for not changing everything. There can also be other complications such as specialized motors found on some types of pumps and machine tools and old motors (where direct interchanges are not readily available). These fall into a cloudy area where change-out may not be justified.

Motors having the greatest potential for savings are those that run on an extended basis with near full load conditions. These are the logical candidates for any change-out program.

## UTILITY REBATE PROGRAMS

A major breakthrough occurred a short time ago when court rulings were passed down so utilities could offer their customers financial help for conservation efforts. Prior to this change utility companies were in a dilemma. If they financed and promoted conservation, the cost of the effort, personnel, equipment, etc., was an expense that reduced their sales and income. This set up a double disincentive for utility support of conservation measures.

Under the new rules, utility money expended on conservation can be considered as a capital investment. Put differently, this means that financing the "buy back" of one kilowatt of capacity through conservation efforts is equivalent, for accounting purposes, to investing money to build a generating plant capable of generating that extra kilowatt. This new accounting approach has unleashed money that utilities are now willing (in some cases mandated) to invest in their customers' conservation efforts. A statement made by one utility indicated it was now possible to "buy back" a kilowatt of capacity for roughly two-thirds of the cost of installing a new kilowatt of capacity. This new approach has turned a losing situation into a win-win situation for utilities and their customers.

The result of this has been a great flurry of activity in utility rebate programs to finance various types of conservation efforts. Again, as with individual initiatives on conservation, lighting has received major attention because it is easy to understand and large gains can be quickly achieved. Electric motors and variable speed drive systems now receive more attention because they represent the equipment that utilizes almost two-thirds of the power generated in the country.

Rebate programs usually handle motors in two different ways. One is a rebate allowed for standard motors that fail in service. This rebate recognizes that the expense involved to remove the old motor and install a new one is going to be necessary. In the "failed motor" programs the rebate is usually reduced, but is based on making it economically feasible to buy the premium efficiency motor to replace the old standard efficiency motor. In this case, only the extra cost difference for the purchase of the premium efficiency motor is recognized and offset.

A second approach is used for operating motors where a higher rebate incentive is offered to cover some of the cost of removal and replacement of an operable motor.

In the case of the operating motors, the rebate is aggressive enough to encourage wholesale change-out of operating motors. In this particular case, in addition to the rebate, the benefits of reduced energy costs are enjoyed by the customer — with few strings attached.

There are many other rebate programs based on different concepts including some where the utility invests in the conservation project and the resulting savings are shared by the utility and the customer over a period of time. Utility rebates in whatever form are a great incentive.

Perhaps the most important aspect is that utility rebates have aroused the commercial and industrial consumer's interest in conservation with motors.

In all rebate programs minimum efficiency standards for the new motors must be met and usually there is a qualifier regarding the number of hours per year the motor must operate to be considered. In situations where rebate programs are offered, especially the aggressive ones, there can be few excuses for not using premium efficiency motors.



## GETTING INVOLVED

The steps for getting involved in upgrading your motor efficiency situation should be as follows:

### **New Equipment**

When purchasing new equipment that will operate for substantial periods of time, ask for the premium efficiency motor option. Written into your request for quotation on air compressors, pumps, HVAC equipment, process machinery, etc., should be a specification that reads something like this: *“Bidder should quote with his choice of standard induction motors and as an alternative, quote on the same machine equipped with premium efficiency motors. Bidder will separate the incremental cost for the addition of the premium efficiency motor(s) and provide the nominal efficiencies of both the standard and the premium efficiency motors offered.”*

By using a specification similar to this, the ultimate owner of the equipment will be in the position to make logical decisions on new motors being installed in the facility. In most cases, the incremental cost for a more energy efficient motor will be relatively small especially when compared with the cost of the equipment it drives.

### **In-Service Failures**

If a motor operates at a high level of load and runs reasonably long hours, replace it with a premium efficiency motor at time of failure.

Motors will normally last for many years if they are operated within reasonable limits and cared for properly. When they do fail it can be almost as expensive to get them repaired as it is to buy a new unit. Also, when a failure occurs the labor to get the old motor removed and a rebuilt or new replacement in place is the same. In some cases, labor can cost more than the motor. This makes time of failure the ideal time to make the change to get a more efficient motor in place.

### **Motor Change-Outs**

Changing operating motors is the most difficult procedure to justify. It becomes feasible if the motors operate at high levels of load, have long hours of service, and especially if a utility rebate is involved.

If these three conditions are met then you can start moving toward realizing bottom line savings available with premium efficiency motors.

Don't ignore the other possibilities. Some great energy saving possibilities in addition to or in conjunction with premium efficiency motors are the use of variable frequency drives. These are great energy savers especially on variable torque loads such as centrifugal pumps, fans and blowers. On these types of loads the horsepower required varies as a cubic function of speed and the energy varies almost in direct relationship to the horsepower. Thus slowing a fan by 15% can yield energy savings of over 35%. Electronic variable frequency drives (VFD's) are extremely reliable and have become relatively inexpensive.

Two speed motors also offer a simple and economical way to reduce energy costs. The speeds are not infinitely adjustable as they are with adjustable frequency drives, but in many situations that degree of adjustment is not necessary, the simplicity and economy of the two speed motor and its control can yield great savings.

Don't ignore the opportunities with small motors. Many motor users in “light industry” and commercial facilities do not recognize the opportunity to save energy because they are of the opinion that their motors are “too small” to be viable candidates for efficiency upgrades. That thought process couldn't be more wrong! The degree of efficiency improvement on motors less than 10 HP is substantially more than it is on larger units. For example, the efficiency improvement between a standard 3 HP motor and a premium efficiency 3 HP motor might be 7 or 8%.

Comparing it in the same way with a 100 HP motor the efficiency gain might be only 2%. The net result is that small motors have the potential for paying off their differential cost faster than large motors.

## OPERATING COSTS AND SAVINGS

### **Rule of Thumb**

To get some perspective on the costs to operate motors and some possible savings, here is a good “Rule of Thumb”.

At 5 cents per kilowatt hour it costs \$1 per horsepower per day to operate a motor at full load. (At 10 cents per kilowatt hour this doubles to \$2 per day.) In some parts of the country, such as Hawaii and Alaska, energy costs run between 20 and 40 cents per kilowatt hour. This value can be ratioed to reflect less than full load or less than continuous operation, etc.

Consider a 100 HP motor operating continuously in a 10 cents per kilowatt hour area. The annual cost of operation comes out to be approximately \$70,000. This can represent about 11 times the first cost of the motor. By spending an extra 30% (\$1200) to get a premium efficiency unit (2.4% more efficient) the annual operating cost could be reduced by approximately \$1800.

In the case of a small 3 HP motor at 10 cents per kilowatt hour, the annual operating cost would be over \$2300 per year and an extra 40% spent on the motor could reduce the operating cost by \$140 per year. In both cases mentioned, the extra cost of the motor would be paid off by energy savings in a few months.

When motors are running continuously at or near full load the initial cost of the motor is usually of little consequence compared with the annual operating cost.

### **OTHER BENEFITS**

Because of their reduced losses, premium efficiency motors run at lower temperatures than equivalent standard motors. This results in longer insulation and lubricant life and less downtime. Inherent in their design is the ability to tolerate wider voltage variations and when necessary, higher ambient temperatures.

An additional benefit is that by generating less waste heat in the space around the motor, building ventilation and/or air conditioning requirements are reduced. This can result in additional savings.

### **SUMMARY**

At the present time electric energy costs are high, but stable. Conservation has reduced the need for new generating facilities and the prices of fuels have been relatively constant. However, many nuclear plants are approaching the end of their useful life. As they are retired and their capacity has to be replaced, capital costs will certainly rise. Also, as the demand for clean burning gas, liquid and solid fuels increases, the cost of these fuels is certain to rise. Thus it is important to seize every reasonable opportunity to conserve now. Adoption of premium efficiency three phase induction motors is an easy and cost effective way to conserve.

## **OPERATING COST FORMULAS** **MOTORS**

$$\text{Kilowatt Hours} = \frac{\text{HP}^{**} \times .746 \times \text{Hours of Operation}}{\text{Motor Efficiency}}$$

\*\* Average Load HP (May be lower than motor nameplate HP)

### **Useful Constants**

Average hours per month	=	730
Hours per year	=	8760
Average hours of darkness per year	=	4000
Approximate average hours per month (single shift operation)	=	200

### **Annual Savings Formula**

$$S = 0.746 \times \text{HP} \times C \times N \left[ \frac{1}{E_S} - \frac{1}{E_{PE}} \right]$$

S	=	Dollars saved per year
HP	=	Horsepower required by load
C	=	Energy cost in dollars per kilowatt hour
N	=	Annual running hours
E <sub>S</sub>	=	Efficiency of standard motor (decimal)
E <sub>PE</sub>	=	Efficiency of premium motor (decimal)

### **General Formula - All Loads**

$$\text{Kilowatt Hours} = \frac{\text{Watts} \times \text{Hours of Operation}}{1000}$$

Approximate Operating Cost\* =

Kilowatt Hours x Average  
Cost per Kilowatt Hour

\* Does not include power factor penalty or demand charges which may be applicable in some areas.





## PREMIUM EFFICIENCY MOTORS – (Q & A)

In spite of the great money and energy saving potential available by using premium efficiency motors, it is surprising that many motor users are not specifying these motors. Some reasons for not using them are misunderstandings about the energy saving potential. The following information is presented in a question and answer format to address some of the myths and questions related to premium efficiency motors.

Question: *Can I save money even when I only have relatively small motors in my plant?*

Answer: The energy saving potential of small premium efficiency motors is actually greater percentage-wise than the savings on large motors. The reason is that on small motors, the percentage difference in efficiency between the standard motor and the premium efficiency motor is actually much greater than it is on larger motors. For example, the difference between a standard motor at 3 HP and the premium efficiency motor could easily be 9 or more percentage points. Compare this to a 100 HP motor where the difference between the standard and premium efficiency motors might only be 2%.

Question: *Do my motors have to be fully loaded to realize the savings available in premium efficiency motors?*

Answer: It is usually advantageous to have motors loaded to more than 50% of rated load for optimum efficiency. Thus, it is usually best to resize a motor at the same time it is upgraded to premium efficiency. However, even if this is not done and the motor is oversized, there is still substantial savings to be gained by utilizing a premium efficiency motor. For example, at 25% of rated load, the difference in efficiency between a standard motor and a premium efficiency motor (of 10 HP) would be 89.5% vs. 92.4%. Thus, the premium efficiency motor is still substantially better even at low load levels than a non-premium efficiency motor. Even without resizing, a substantial efficiency improvement can be made.

Question: *How much more do premium efficiency motors cost?*

Answer: Generally, premium efficiency motors cost 20 to 30% more depending upon the size and speed of the motor.

Question: *Why do premium efficiency motors cost more than standard motors?*

Answer: Premium efficiency motors use more and better materials. For example, the lamination material is a higher grade, higher cost steel. In addition, the rotor and stator are generally longer in a premium efficiency motor than in a standard motor. The laminations are thinner compared to a standard efficiency motor. This means there are more laminations. In addition, the lamination slots are larger so more copper can be used in the windings. Finally, premium efficiency motors are manufactured in smaller production lots which also tends to make them more expensive.

Question: *If premium efficiency motors can save lots of money, why don't more people use them?*

Answer: This is a tough question but is probably related to the fact that many people buy on first cost rather than considering operating costs. Also, there seems to be skepticism about manufacturer's claims on performance of these motors. Many power users that have been very active in other energy conserving programs such as lighting, insulating etc., have ignored the energy-saving potential of premium efficiency motors.

Question: *Why can't motor manufacturers make it more obvious that we are going to save money with these motors?*

Answer: Unlike light bulbs that are sold by wattage consumption (input), electric motors are sold by horsepower (output). Thus, subtle differences in efficiency usually appear in the fine print and get overlooked. For example, it is obvious when you buy a 34 watt fluorescent light bulb to replace a 40 watt bulb, that some savings are available. It is less obvious when you buy a 5 HP motor of one design versus a 5 HP motor of a premium efficiency design, that there will be savings on the electric bill. Also, the vagaries of electric bills and the complications involved in the electric billing process with demand charges, energy charges, fuel cost adjustments and occasionally, power factor penalties, create enough confusion so savings are not obvious. But they exist.

Question: *How can I evaluate the dollar savings on premium efficiency motors?*

Answer: There are three items needed to conduct an evaluation. First and most important, is the average cost per kilowatt hour of electricity. The simplest and most direct way to get this is to take the bottom line cost on a monthly electric bill and divide it by the total kilowatt hours used. This gives a net cost per kilowatt hour which is generally the best cost to use in evaluating energy saving equipment. The reason this works is that equipment designed for better efficiency will in general, reduce the demand, kilowatt hours, and fuel cost adjustments in equal proportions. Thus, using the average cost per kilowatt hour is the easiest way of making an evaluation. Next would be the HP size of the motor that is operating and, finally, the number of hours per month or year that it operates. With these three items and the efficiency difference between one motor and the other, it is easy to figure the cost savings. The formulas for doing this appear on page 74.. If in doubt, let us have the information and we'll make the calculations for you.

Question: *How quickly will these motors pay for themselves?*

Answer: This is impossible to answer without all the facts from the previous question but motors operating twenty-four hours a day at or near full load, can be expected to pay for themselves in less than two years. The difference between a standard motor's cost and a premium efficiency motor's cost can be paid off in a few months. One thing is certain: regardless of the operating details, premium efficiency motors will always save money versus lower efficiency units and savings go on for as long as the motor is in operation. In many cases this could be twenty to thirty years. Also, as power costs rise, savings will rise in proportion. The old rule of "pay me now or pay me later" has a corollary when applied to premium efficiency motors which might be "pay a little more now and save some now and more later."

Question: *Are there any other advantages to premium efficiency motors?*

Answer: Yes, because of the superior designs and better materials used in them, premium efficiency motors tend to run at lower operating temperatures resulting in longer life for lubricants, bearings and motor insulation. Another advantage is that, by generating less waste and less heat in the space around the motor, air conditioning and ventilation requirements are reduced, resulting in additional energy savings.

Question: *What is the best way to take advantage of premium efficiency savings potential?*

Answer: Specify motors that meet the NEMA Premium® efficiency requirements on new equipment and as replacement units for failures. Some judgement should be used on blanket specifications. For example, it may be impractical to try to specify premium efficiency motors for single phase, fractional horsepower, and specialized motor requirements or where the motor is an integral part of the equipment. Also, on motor installations where infrequent service is required, the extra cost may not be justified. Examples of this would be trash compactors, batch mixers and other equipment that only operate for short periods of time. It might also be difficult to justify the added cost of premium efficiency motors on equipment that operates on a seasonal basis, especially if the season is short.



In summary, it is important to seize the opportunity to move into premium efficiency motor use as soon as possible. If you have questions not covered above, please give us a call. We'll get you the answers.



# AMPS, WATTS, POWER FACTOR AND EFFICIENCY

## WHAT DO YOU REALLY PAY FOR?

### INTRODUCTION

There seems to be a great deal of confusion among the users of electric motors regarding the relative importance of power factor, efficiency and amperage, as related to operating cost. The following information should help to put these terms into proper perspective.

At the risk of treating these items in reverse order, it might be helpful to understand that in an electric bill, commercial, industrial or residential, the basic unit of measurement is the kilowatt hour. This is a measure of the amount of energy that is delivered. In many respects, the kilowatt hour could be compared to a ton of coal, a cubic foot of natural gas, or a gallon of gasoline, in that it is a basic energy unit. The kilowatt hour is not directly related to amperes, and at no place on an electric bill will you find any reference to the amperes that have been utilized. It is vitally important to note this distinction. You are billed for kilowatt hours: you do not necessarily pay for amperes.

### POWER FACTOR

Perhaps the greatest confusion arises due to the fact that early in our science educations, we were told that the formula for watts was amps times volts. This formula,  $\text{watts} = \text{amps} \times \text{volts}$ , is perfectly true for direct current circuits. It also works on some AC loads such as incandescent light bulbs, quartz heaters, electric range heating elements, and other equipment of this general nature. However, when the loads involve a characteristic called inductance, the formula has to be altered to include a new term called power factor. Thus, the new formula for single phase loads becomes, watts are equal to  $\text{amps} \times \text{volts} \times \text{power factor}$ . The new term, power factor, is always involved in applications where AC power is used and inductive magnetic elements exist in the circuit. Inductive elements are magnetic devices such as solenoid coils, motor windings, transformer windings, fluorescent lamp ballasts, and similar equipment that have magnetic components as part of their design.

Looking at the electrical flow into this type of device, we would find that there are, in essence, two components. One portion is absorbed and utilized to do useful work. This portion is called the real power. The second portion is literally borrowed from the power company and used to magnetize the magnetic portion of the circuit. Due to the reversing nature of AC power, this borrowed power is subsequently returned to the power system when the AC cycle reverses. This borrowing and returning occurs on a continuous basis. Power factor then becomes a measurement of the amount of real power that is used, divided by the total amount of power, both borrowed and used. Values for power factor will range from zero to 1.0. If all the power is borrowed and returned with none being used, the power factor would be zero. If on the other hand, all of the power drawn from the power line is utilized and none is returned, the power factor becomes 1.0. In the case of electric heating elements, incandescent light bulbs, etc., the power factor is 1.0. In the case of electric motors, the power factor is variable and changes with the amount of load that is applied to the motor. Thus, a motor running on a work bench, with no load applied to the shaft, will have a low power factor (perhaps .1 or 10%), and a motor running at full load, connected to a pump or a fan might have a relatively high power factor (perhaps .88 or 88%). Between the no load point and the full load point, the power factor increases steadily with the horsepower loading that is applied to the motor. These trends can be seen on the typical motor performance data plots which are shown in figure 1.

## **EFFICIENCY**

Now, let's consider one of the most critical elements involved in motor operating cost. This is efficiency. Efficiency is the measure of how well the electric motor converts the power that is purchased into useful work. For example, an electric heater such as the element in an electric stove, converts 100% of the power delivered into heat. In other devices such as motors, not all of the purchased energy is converted into usable energy. A certain portion is lost and is not recoverable because it is expended in the losses associated with operating the device. In an electric motor, these typical losses are the copper losses, the iron losses, and the so-called friction and windage losses associated with spinning the rotor and the bearings and moving the cooling air through the motor.

In an energy efficient motor, the losses are reduced by using designs that employ better grades of material, more material and better designs, to minimize the various items that contribute to the losses in the motor.

For example, on a 10 HP motor, a Super-E® energy efficient design might have a full load efficiency of 92.4%, meaning that, at full load (10 HP), it converts 92.4% of the energy it receives into useful work. A less efficient motor might have an efficiency of 82%, which would indicate that it only converts 82% of the power into useful work.

In general, the efficiency of motors will be relatively constant from 50% to 100% of rated load.

## **AMPERES**

Now, let's discuss amperes. Amperes are an indication of the flow of electric current into the motor. This flow includes both the borrowed as well as the used power. At low load levels, the borrowed power is a high percentage of the total power. As the load increases on the motor, the borrowed power becomes less and less of a factor and the used power becomes greater. Thus, there is an increase in the power factor as the load on the motor increases. As the load continues to increase beyond 50% of the rating of the motor, the amperage starts to increase in a nearly straight line relationship. This can be seen in figure 1.

## **SUMMARY**

Figure 1 shows significant items that have been discussed as plots of efficiency, power factor and watts, as they relate to horsepower. The most significant factor of all these is the watts requirement of the motor for the various load levels because it is the watts that will determine the operating cost of the motor, not the amperage.

The customer that has an extremely low power factor in the total plant electrical system, may be penalized by his utility company because he is effectively borrowing a great deal of power without paying for it. When this type of charge is levied on the customer, it is generally called a power factor penalty. In general, power factor penalties are levied only on large industrial customers and rarely on smaller customers regardless of their power factor. In addition, there are a great many types of power customers such as commercial establishments, hospitals, and some industrial plants that inherently run at very high power factors. Thus, the power factor of individual small motors that are added to the system, will not have any significant effect on the total plant power factor.

It is for this reasons that the blanket statement can be made, that increasing motor efficiency will reduce the kilowatt hour consumption and the power cost for all classes of power users, regardless of their particular rate structure or power factor situation. This same type of statement cannot be made relative to power factor.

BALDOR ELECTRIC COMPANY

WINDING # 09WGX717

Typical performance - not guaranteed values.

15 HP 3 PH 60 HZ 1765 RPM 460 V 0936M

TORQUES (LB-FT): P0=165 PU=68.2 LR=79.1 LRA=122.9

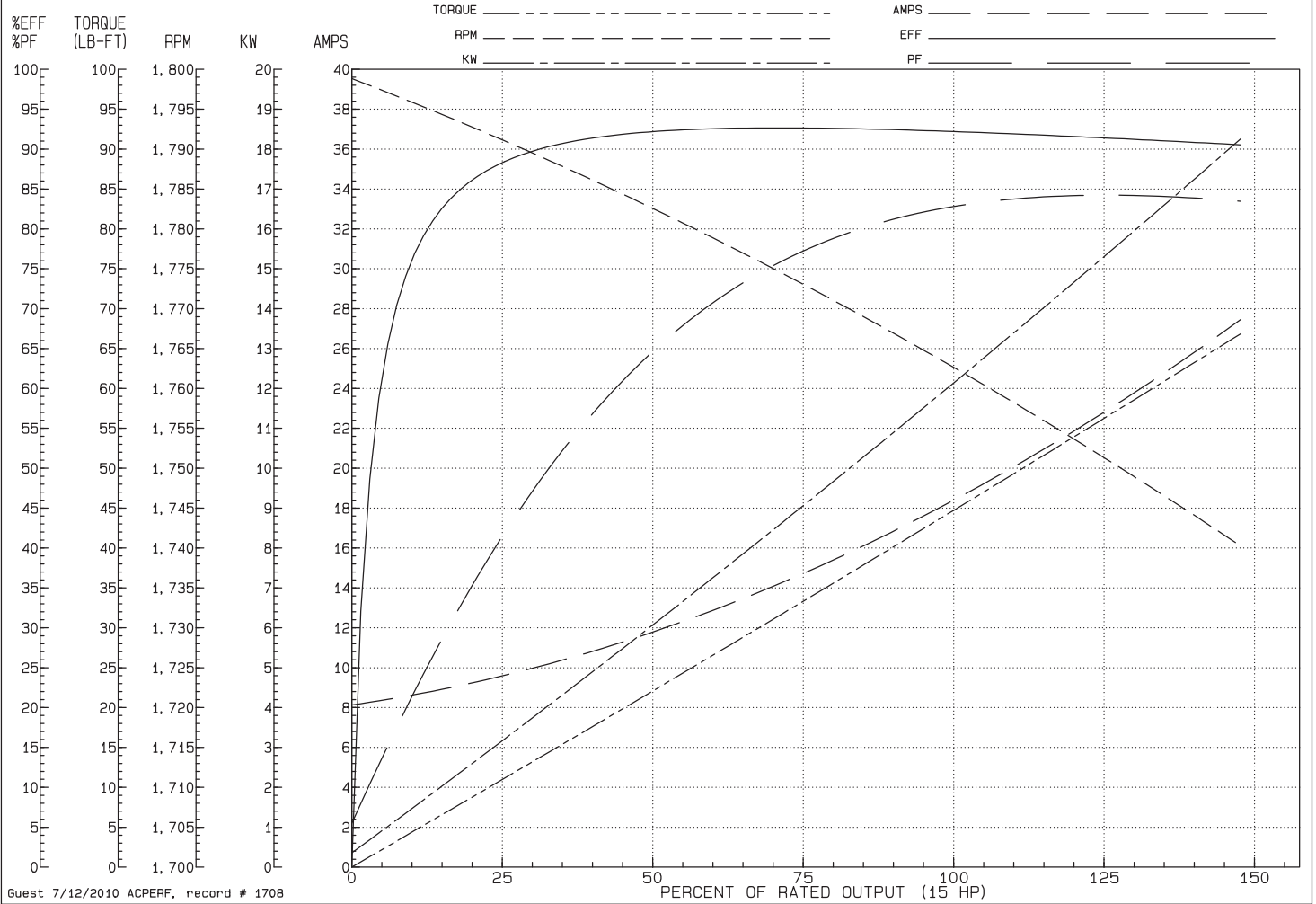

Figure 1

The following basic equations are useful in understanding and calculating the factors that determine the operating costs of motors and other types of electrical equipment.

## **OPERATING COST CALCULATIONS**

### **MOTORS**

$$\text{Kilowatt Hours} = \frac{\text{HP}^{**} \times .746 \times \text{Hours of Operation}}{\text{Motor Efficiency}}$$

\*\* Average Load HP (May be lower than Motor Nameplate HP)

### General Formula All Loads

$$\text{Kilowatt Hours} = \frac{\text{Watts} \times \text{Hours of Operation}}{1000}$$

Approximate Operating Cost\* = Kilowatt hours x Average Cost per Kilowatt Hour

\* Does not include power factor penalty or demand charges which may be applicable in some areas.

### Useful Constants

Average Hours per Month	=	730
Average Hours per Year	=	8760
Average Hours of Darkness per Year	=	4000
Approximate Average Hours per Month (Single Shift Operation)	=	200



# APPROXIMATE LOAD DATA FROM AMPERAGE READINGS

## CONDITIONS

1. Applied voltage must be within 5% of nameplate rating.
2. You must be able to disconnect the motor from the load.  
(By removing V-belts or disconnecting a coupling).
3. Motor must be 7-1/2 HP or larger, 3450, 1725, or 1140 RPM.
4. The indicated line amperage must be below the full load nameplate rating.

## PROCEDURE

1. Measure and record line amperage with load connected and running.
2. Disconnect motor from load. Measure and record the line amperage when the motor is running without load.
3. Read and record the motor's nameplate amperage for the voltage being used.
4. Insert the recorded values in the following formula and solve.

$$\% \text{ Rated HP} = \frac{(2 \times \text{LLA}) - \text{NLA}}{(2 \times \text{NPA}) - \text{NLA}} \times 100$$

Where:

LLA = Loaded Line Amps

NLA = No Load Line Amps  
(Motor disconnected from load)

NPA = Nameplate Amperage  
(For operating voltage)

Please Note: This procedure will generally yield reasonably accurate results when motor load is in the 40 to 100% range and deteriorating results at loads below 40%.

*FOR AN EXAMPLE AND SAMPLE CALCULATION, SEE NEXT PAGE*

Example:

A 20 HP motor driving a pump is operating on 460 volts and has a loaded line amperage of 16.5.

When the coupling is disconnected and the motor is operated at no load the amperage is 9.3.

The motor nameplate amperage for 460 volts is 19.4.

Therefore we have:

Loaded Line Amps    LLA = 16.5

No Load Amps        NLA = 9.3

Nameplate Amps     NPA = 19.4

$$\% \text{ Rated HP} = \frac{(2 \times 16.5) - 9.3}{(2 \times 19.4) - 9.3} \times 100 = \frac{23.7}{29.5} \times 100 = 80.3\%$$

Approximate load on motor slightly over 16 HP.

# POWER FACTOR CORRECTION ON SINGLE INDUCTION MOTORS

## INTRODUCTION

Occasionally we get asked to size power factor correction capacitors to improve the power factor of a single motor. Usually the requested improved power factor level is 90 or 95%. The necessary calculations to get the proper capacitor KVAR (Kilovolt Ampere Reactive) value are straightforward, but since we don't do it often it is nice to have the method in writing.

## PROCEDURE

The first thing needed is the full load power factor and efficiency information for the motor. On Baldor motors this can be found on the internet at [www.Baldor.com](http://www.Baldor.com). Next, since most power factor tables are worked in terms of Kilowatts, it is necessary to convert the motor output rating into Kilowatts. The procedure for doing this is to take the motor HP multiplied by the constant for KW per HP (0.746). This will give Output KW. Then it is necessary to divide this by the efficiency of the motor (as a decimal) to get the Input KW at full load. Next, refer to power factor correction Table I going in from the left with the existing power factor and coming down from the top with the desired power factor. Where they intersect find the multiplier needed.

Next, multiply the motor Input Kilowatts by the appropriate multiplier from Table 1 to get the required KVAR of power factor correction. This value would be rounded out to match commercially available power factor correction capacitor ratings shown in Table 2.

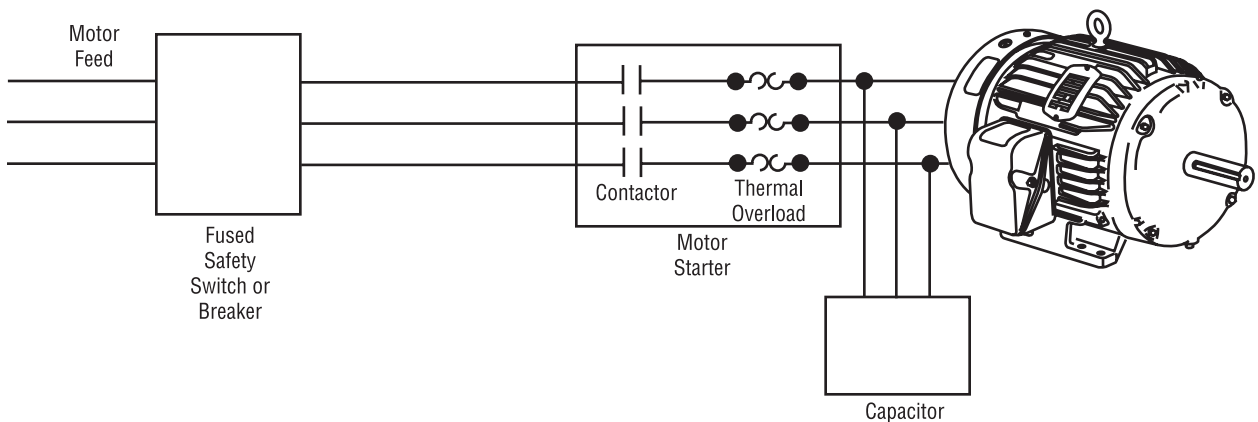

Figure 1

**TABLE 1**

<b>ORIGINAL FACTOR %</b>	<b>DESIRED POWER FACTOR %</b>		
	<b>85</b>	<b>90</b>	<b>95</b>
60	0.713	0.849	1.004
62	0.646	0.782	0.937
64	0.581	0.717	0.872
66	0.518	0.654	0.809
68	0.458	0.594	0.749
70	0.400	0.536	0.691
72	0.344	0.480	0.635
74	0.289	0.425	0.580
76	0.235	0.371	0.526
77	0.209	0.345	0.500
78	0.182	0.318	0.473
79	0.156	0.292	0.447
80	0.130	0.266	0.421
81	0.104	0.240	0.395
82	0.078	0.214	0.369
83	0.052	0.188	0.343
84	0.026	0.162	0.317
85	0.000	0.136	0.291
86		0.109	0.264
87		0.083	0.238
88		0.056	0.211
89		0.028	0.183
90		0.000	0.155
91			0.127
92			0.097
93			0.066
94			0.034
95			0.000



## **CURRENT CORRECTION**

In many cases when a single motor is being corrected, the capacitors are connected between the motor starter and the motor at the motor terminals as shown in Figure 1. With this being the case, the effect of the correction is to reduce the current flowing through the starter and overload relay. Since the overload heaters are selected (or adjusted) on the basis of the motor full load current, this means that the overloads will not correctly protect the motor unless the ampacity is reduced to reflect the reduced current now flowing as a result of the power factor improvement.

The motor itself will draw the same number of amps at full load as it would without the Power Factor Correction. However, the power factor correction capacitors will be supplying a portion of the current and the balance will be coming through the starter from the power line.

The new value of current passing through the overloads is given by the following formula:

$$\text{Current}_{\text{new}} = \text{Motor Full Load (Nameplate) Amps} \times \frac{\text{Power Factor Original}}{\text{Power Factor Corrected}}$$

For example, in the case of the 100HP motor in the example, the heater size, which would normally be selected from the motor nameplate current at 118 amps would have to be adjusted as follows:

$$\text{Current}_{\text{new}} = 118 \times \frac{.85}{.95} = 118 \times .895 = 105.6 \text{ or approximately } 106 \text{ amps}$$

## **SUMMARY**

A few words of caution might be appropriate. Usually it is desirable to “under correct” rather than “over correct”. If the capacitors chosen are too large there can be a number of problems, including high transient torques and overvoltage. Thus it is usually desirable not to attempt to improve power factor beyond 95%. It also usually becomes uneconomical to attempt improvements beyond 95%.

Please note: This type of power factor improvement should not be used in any situation where the motor is being controlled by a solid state device such as a soft start control or a variable frequency drive.

# CONVENIENT MOTOR & ENERGY FORMULAS

$$\text{Synchronous Speed} = \frac{120 \times \text{frequency}}{\text{No. of Poles}}$$

Poles can be 2, 4, 6, 8, etc.

(Over 95% of motors sold are 2, 4, or 6 pole.)

$$\text{Horsepower (HP)} = \frac{\text{Torque} \times \text{Speed}}{\text{Constant}}$$

Speed in RPM

Value of Constant depends on units used for torque

<u>Torque Units</u>	<u>Constant Value</u>
Pound Feet	5252
Pound Inches	63,025
Ounce Inches	1,000,000

## Horsepower Required by Pumps

Centrifugal Pumps

$$\text{HP} = \frac{\text{Gallons per Minute} \times \text{Head in Feet}}{3960 \times \text{pump efficiency}}$$

Hydraulic Pumps

$$\text{HP} = \frac{\text{Gallons per Minute} \times \text{Pounds per sq. inch}}{1714 \times \text{pump efficiency}}$$

## Fans and Blowers

$$\text{HP} = \frac{\text{C F M} \times \text{Pressure (Inches of Water)}}{6356 \times (\text{fan or blower}) \text{ efficiency}}$$

Normal efficiency range is 50 to 75 percent.

## Air Compressor Rule of Thumb

1 HP produces 4 CFM @ 100 PSI

## Approximate Full Load Amps (3 Phase Motors)

$$\text{Amps} = \text{HP} \times 1.2 \times \frac{460}{\text{Motor Voltage}}$$

$$\text{Motor Watts (at full load)} = \frac{\text{HP} \times 746}{\text{Efficiency}}$$

Divide Watts by 1000 to get KW (Kilowatts)

## OPERATING COST CALCULATION

### Operating Cost on Motors

$$\text{Kilowatt Hours} = \frac{\text{HP}^{**} \times .746 \times \text{Hours of Operation}}{\text{Motor Efficiency (Decimal)}}$$

\*\*Average Load HP (may be lower than motor nameplate HP)

### GENERAL FORMULA – ALL LOADS

$$\text{Average Hours per Month} = 730$$

$$\text{Average Hours per Year} = 8760$$

$$\text{Average Hours of Darkness per Year} = 4000$$

$$\text{Approximate Average Hours per Month} = 200$$

(Single Shift Operation)

$$\text{Annual Operating Cost} = \text{Annual Kilowatt Hours} \times \text{Cost per KW Hour}$$

Example:

A fully loaded 20 HP motor with FL efficiency of 91.0% runs 2500 hours per year, at a location where power costs 7.5¢ per kilowatt hour.

What is the annual operating cost?

$$\text{Annual Kilowatt Hours} = \frac{20 \times .746 \times 2500}{.910} = 40,989$$

$$\text{Annual Operating Cost} = 40,989 \times .075 = \$3,074$$



# HORSEPOWER CALCULATIONS FOR SPEED CHANGES ON VARIABLE TORQUE LOADS (Fans, Blowers, & Centrifugal Pumps)

$$HP_{\text{new}} = HP_{\text{original}} \times \left( \frac{\text{Speed New}}{\text{Speed Original}} \right)^3$$

Example:

Original HP = 7.5

Original Blower Speed      900 RPM

New Blower Speed            750 RPM

Determine new HP

$$HP_{\text{new}} = 7.5 \times \left( \frac{750}{900} \right)^3 \quad \text{or} \quad 7.5 \times \frac{750}{900} \times \frac{750}{900} \times \frac{750}{900} =$$

$$7.5 \times .83 \times .83 \times .83 =$$

$$7.5 \times .57 = 4.3 \text{ HP}$$

Note: Driving Energy Requirement (Watts) go up and down at approximately the same rate as HP.



# **HOW TO SELECT MOTORS FOR HAZARDOUS LOCATIONS**

By Edward Covern, P.E.,

# How To Select Motors for Hazardous Locations

By EDWARD COWERN, P.E.

**F**AILURE TO SPECIFY the proper motor for use in a hazardous location can have serious consequences — lost production, extensive property damage, and even loss of human life. Selection of the proper motor requires an understanding of underwriters' Laboratories' (UL) and National Electrical Code (NEC) Class, Group and Division designations and the T code letters.

In some plant engineering departments, there may be only a vague understanding of the selection criteria of motors for hazardous locations. In some cases, the specifier passes the buck to another party in the hope that someone — perhaps the motor manufacturer — will fill in the missing specification data. In other cases, the same type of motor that had been used in the plant previously is specified, with the hope that this approach will certainly handle any situation. But this approach can greatly increase the cost of the project, and, in some cases, result in a motor that is inadequate for the application.

Hazardous locations are operating environments in which explosive or ignitable vapors or dust is present, or is likely to become present. Special motors are required to ensure that any internal fault in the motor will not ignite the vapor or dust. Requirements for electrical installations in hazardous locations are covered in Articles 500, 501, 502, 503, 510, 511, 513, 514, 515, and 516 of the *National Electrical Code*.

A relatively new article 505 makes an abrupt change in traditional hazardous location requirements and brings the NEC closer to the somewhat less stringent European code requirements by classifying areas into three separate zones 0, 1 and 2. This section tends to involve wiring practices and components rather than motors so it will not be included in the discussion to follow.

At the present time article 505 sets forth some principles, but it will be some time before equipment suppliers will have products available to match the new requirements. We can also expect the “inertia of habit” to slow the change to the somewhat relaxed zone requirements. Perhaps the changes will be used first by multinational companies where engineers are more familiar with the zone system and matching hardware.

The term “explosion proof” is often erroneously thought to apply to any hazardous-location motor. Explosion proof motors, however, are only those approved for Class I locations — that is, where

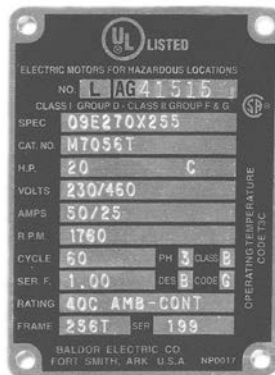

An Underwriters' Laboratories nameplate is used on all motors approved for use in Division 1 hazardous locations. In addition to the normal motor data such as horsepower, speed, voltage, amperage, NEMA Code Letter, etc. it also shows the specific Class(es) and Group(s) for which the motor is approved. In the example shown the motor is approved for Class I Group D and Class II Groups F and G. The T code is also indicated.

potentially explosive gases or vapors are present. A Class I unit is constructed to contain an explosion within itself without rupturing. After the initial pressure buildup on ignition, the hot gas is forced to cool by passing through long, tight passageways (flame paths) before escaping from the motor. The temperature of gas escaping from the motor will then be below the minimum ignition temperature (MIT) of the gases of vapors in the atmosphere surrounding the motor.

**Meaning of Motor “Class” Designations** — Every motor approved for hazardous locations carries an Underwriters' Laboratories' nameplate that indicates the motor is approved for hazardous locations (see illustration). This nameplate identifies the motor as having been designed for operation in Class I or Class II locations. Some motors may be approved for both Class I and II locations.

Basically, the Class identifies the physical characteristics of the hazardous materials present at the location where the motor will be used. Class I covers gases, vapors, or liquids that are explosive or else pose a threat as ignitable mixtures. A familiar example of a Class I material is gasoline. It is explosive as a vapor and ignitable as a liquid. Some of the most common Class I substances are listed in Table 1.

Class II covers dusts — specifically, dust in amounts sufficient to create explosive mixtures, and dusts that are electrically conductive. A prime example of a hazardous dust is wheat flour. As a compact mass, flour burns or smolders; but when it is finely distributed in air, it is highly explosive. Also included in Class II are electrically conductive metallic and nonmetallic dusts, such as powdered aluminum and magnesium, and pulverized coal. Aluminum and magnesium dusts can burn violently even when not suspended in air; but when airborne, they are explosive. Some common Class II substances are listed in Table 2.

Class III locations do not normally require hazardous-location motors. Specifying a hazardous-location motor for Class III locations is a common error. Section 503-6 of the NEC permits a totally enclosed fan-cooled or nonventilated motor to be used in Class III locations. A totally enclosed motor can be purchased at lower cost than a motor approved for hazardous locations. NEC Section 503-6 also allows the use of an open drip-proof motor in Class III locations, if the inspection authority is satisfied that proper housekeeping will be maintained. Class III locations are those where easily ignitable fibers and “flyings” are likely to be present. Such substances are commonly encountered in the textile, woodworking, and plastics industries. Class III materials are not normally airborne, because they are fairly heavy and settle rapidly. They are, however, quite flammable, and, therefore, create a potentially hazardous condition when near electrical equipment. Common Class III substances are listed in Table 3.

**Meaning of “Group” Designations** — Within Class I and Class II, Group designations are assigned to various combustible substances on the basis of their behavior after ignition. Group designations A through G are arranged in descending order according to the stringency of motor design requirements; Group A requirements would require the longest flame paths and tightest fits. Groups A through D fall within Class I, and Groups E, F, and G fall within Class II. Class III materials are not broken down by group.

Gasoline and acetylene provide an illustration of the group concept. Both are Class I substances. Acetylene is designated as a Group A substance, gasoline falls within Group D. MIT of automotive gasoline is 280° C (536° F), slightly below the 305° C (581° F) MIT of acetylene. An acetylene explosion, however, is more intense than a gasoline explosion, so acetylene is grouped well above gasoline.

It is a common misconception that Class I transcends Class II and that a Class I motor will automatically satisfy any Class II requirement. But, a Class I motor is designed primarily to confine the effects of an internal motor explosion. Design is based on the assumption that, over a period of time, normal heating and cooling will cause the motor to breathe the surrounding atmosphere, and the atmosphere within the motor will, eventually, become the same as that of the operating environment. A subsequent internal fault can, therefore, cause an explosion within the motor.

A Class II motor, however, is designed to maintain the motor’s surface temperature at a level such that Class II materials in the motor operating environment will not be heated to their MIT. If the operating environment contains both Class I and Class II substances, a dual-rated Class I/Class II motor must be specified.

Another common misconception is that because the Classes and Groups exist — then there should be suitable products (motors or other equipment) to operate in the defined environment. As it turns out, Classes and Groups are used for all types of equipment including enclosures, light fixtures, heating elements, operator devices, etc. But just because there is a definition it doesn’t mean that a matching product is available. In the case of motors this is especially true for Class I Groups A and B. Apparently the market for motors to operate in these environments is so limited,

**TABLE I, CLASS I SUBSTANCES AND ATMOSPHERES**

Substance or Atmosphere	Minimum Ignition Temperature
<b>Group A</b>	
acetylene	305° C (581° F)
<b>Group B</b>	
butadiene	420° C (788° F)
ethylene oxide	570° C (1058° F)
hydrogen	500° C (932° F)
<b>Group C</b>	
acetaldehyde	175° C (347° F)
cyclopropane	498° C (928° F)
diethyl ether	180° C (356° F)
ethylene	450° C (842° F)
isoprene	395° C (743° F)
unsymmetrical dimethyl hydrazine (UDMH) 1, 1-dimethyl hydrazine)	249° C (480° F)
<b>Group D</b>	
acetone	465° C (869° F)
acrylonitrile	481° C (898° F)
ammonia	651° C (1204° F)
benzene	498° C (928° F)
butane	287° C (550° F)
1-butanol (butyl alcohol)	343° C (650° F)
2-butanol (secondary butyl alcohol)	405° C (761° F)
n-butyl acetate	425° C (797° F)
isobutyl acetate	421° C (790° F)
ethane	472° C (882° F)
ethanol (ethyl alcohol)	363° C (685° F)
ethyl acetate	426° C (800° F)
ethylene dichloride	413° C (775° F)
gasoline	280° C (536° F)
heptane	204° C (399° F)
hexane	225° C (437° F)
methane (natural gas)	537° C (999° F)
methanol (methyl alcohol)	464° C (867° F)
3-methyl-1-butanol (isoamyl alcohol)	350° C (662° F)
methyl ethyl ketone	404° C (759° F)
methyl isobutyl ketone	448° C (840° F)
2-methyl-1-propanol (isobutyl alcohol)	415° C (780° F)
2-methyl-2-propanol (tertiary butyl alcohol)	478° C (892° F)
octane	206° C (403° F)
petroleum naphtha	288° C (550° F)
1-pentanol (amyl alcohol)	300° C (572° F)
propane	450° C (842° F)
1-propanol (propyl alcohol)	412° C (775° F)
2-propanol (isopropyl alcohol)	399° C (750° F)
propylene	455° C (851° F)
styrene	490° C (914° F)
vinyl acetate	402° C (756° F)
vinyl Chloride	472° C (882° F)
p-xylene	528° C (984° F)

and the designs so difficult, that most manufacturers do not make them.

The most common hazardous location motors are made for Class I Group D and Class II Groups F and G. Several manufacturers can build motors for Groups C and E but they are normally made on a special order basis.

**TABLE II. CLASS II SUBSTANCES**

Group	General definitions	Examples
E	Metallic dusts	Dusts of aluminum, magnesium, their commercial alloys and other metals of similarly hazardous characteristics
F	Electrically conducting non-metallic dusts	Coal dust Pulverized coal Pulverized coke Pulverized charcoal Carbon black and similar substances
G	Electrically non-conducting dusts	Grain dusts Grain product dusts Pulverized sugar Pulverized starch Dried powdered potato Pulverized cocoa Pulverized spices Dried egg and milk powder Wood flour Oilmeal from beans and seeds Dried hay and other products producing combustible dust when dried or handled and other similar substances

**TABLE III. CLASS III SUBSTANCES  
(NO GROUPS ASSIGNED)**

Ignitable Fibers or Flyings	
Rayon	Cotton
Sawdust	Sisal
Henequen	Istle
Jute	Hemp
Tow	Cocoa fiber
Oakum	Baled waste kapok
Spanish moss	Excelsior
(and other materials of similar nature)	

**TABLE IV. T CODES AND THEIR ASSOCIATED TEMPERATURES**

T Number	Maximum motor surface temperature	
	C	F
T1	450	842
T2	300	572
T2A	280	536
T2B	260	500
T2C	230	446
T2D	215	419
T3	200	392
T3A	180	356
T3B	165	329
T3C	160	320
T4	135	275
T4A	120	248
T5	100	212
T6	85	185

**Meaning of “Division”** — Hazardous locations are further broken down into Division 1 and Division 2. The distinctions are defined in detail in Article 500 of the NEC. Simply stated, a Division 1 location is one in which ignitable substances are likely to be present continuously or intermittently in the course of normal operations. In a Division 2 location, ignitable materials are handled or stored in a manner that allows the combustible substance to escape in the event of spill, accident, or equipment failure.

For a complete list of Class I materials refer to NFPA 325 – “Guide to Fire Hazard Properties of Flammable Liquids, Gases and Volatile Solids”.

Division distinctions are concerned primarily with installation procedures required by the NEC. Class I and Class II motors for hazardous locations have no Division designation on the UL label. All Class I and Class II motors are designed to meet Division 1 requirements and are, therefore, suitable for installation in both Division 1 and Division 2 locations.

**Hazardous-Location Motor T Codes** — All motors manufactured after February 1975 carry a T code designation (Table 4). The T code identifies the maximum absolute motor surface temperature that will be developed under all conditions of operation, including overload up to and including motor burnout. The T code designation of the motor must be correlated with the Minimum Ignition Temperature (MIT) of the substances in the motor’s operating environment.

The presence of acetone or gasoline, for example, will affect motor selection. Acetone and gasoline are both Class I, Group D materials. Acetone has an MIT of 465° C (869° F) (Table IV) indicates that a motor with a T1 rating (450° C maximum surface temperature) would be acceptable for operation in an acetone environment.

Gasoline, however, has an MIT of 280° C (536° F). For operation in an environment containing gasoline, no less than a T2A motor, designed to develop a surface temperature no greater than 280° C, should be specified (Table 4). Although T codes and ignition temperatures are conservatively assigned and are based on “worst case” testing procedures, an extra margin of safety should be provided by specifying a T2B or higher T rated motor, designed to develop a maximum surface temperature of 260° C (500° F).

Meeting some of the lower temperature T Code requirements necessitates the use of automatic thermal overload devices (fractional horsepower motors) or normally closed (NC) winding thermostats in larger (integral horsepower) motors.

Winding thermostats are control devices with relatively low current capacity. They have to be connected to the motor’s magnetic starter to cause

it to interrupt power to the motor when the internal temperature gets too high. Failure to make the required “control circuit” connection will negate the motor nameplate T Code rating.

In a motor designed for Division 1 use, the winding thermostats are mounted inside the frame's flame path. On Division 2 motors, such a construction is not used, so thermostats and any other accessory must be intrinsically safe as discussed in IEEE 303. "Recommended practice for Auxiliary Devices for Rotating Electrical Machines in Class I, Division 2 and Zone 2 locations".

**Use with Inverter Power Supply** — Unlike standard motors which can readily be used with Adjustable Speed Drives, motors used in Division 1 and 2 locations need specific certification and marking indicating suitability for the specific class and group, speed range and constant or variable torque. Most manufacturers have a specific family of Inverter Duty Explosion Proof motors suitable for Division 1 or 2 locations. Standard motors that are suitable for Division 2 use may be name plated with their speed capabilities. Intrinsically Safe Auxiliary devices must be used.

**Additional Sources of Information** — In addition to the NEC, three other publications of the National Fire Protection Association (NFPA)\* will be helpful in selecting the proper motor. NFPA publication 325, mentioned previously, covers the properties of hazardous liquids, gases, and volatile solids, and provides a more comprehensive listing of hazardous substances than does Table 1. NFPA 497 — “Recommended Practice for the Classification of Flammable Liquids, Gases, or Vapors and of Hazardous (Classified) Locations for Electrical Installations in Chemical Process Areas” will help classify installations and areas. NFPA 499 — “Recommended Practice for the Classification of Combustible Dusts and of Hazardous (Classified) Locations for Electrical Installations in Chemical Process Areas” covers Class II substances. Each publication provides MIT’s for the substances covered in the respective publications.

The field service representative of the plant’s insurance underwriter can also provide advice when there is uncertainty as to what type of motor is required for a particular hazardous-location application.

\*NFPA publications can be obtained from National Fire Protection Association, 1 Batterymarch Park, P.O. Box 9101, Quincy, MA 02269-9101.





# EXPLOSION PROOF MOTORS IN DIVISION 2 AREAS

We have found that one of the most confusing things about explosion proof requirements involves the application of motors in Division 2 areas.

To put things in perspective, **Division 1** involves areas where hazardous liquids, vapors, gases or hazardous dusts are present a good deal of the time or even all the time in the normal course of events. **Division 2** areas are where the hazardous materials are only apt to be in the area if there is a spill, accident, loss of ventilation or some other unusual condition. The treatment of both of these divisions is covered in Article 500 of the National Electric Code (NEC).

Once an area has been identified as being either Division 1 or Division 2, the National Electric Code requires certain types of motors be used in those environments. Division 1 areas always require hazardous location (explosion proof) motors having the class and group approvals that match the particular hazardous substance in the area. Thus, for Division 1 requirements, explosion proof equipment must be used. On the other hand, if an area has been classified as Division 2, the National Electric Code will frequently allow the use of totally enclosed (or even open drip proof) motors provided certain conditions are met. Basically, those conditions relate to there not being any hot surfaces or sparking parts in the motor. For example, sparking parts could be brushes (as found in DC motors), switching devices (such as centrifugal switches used in many single phase motors), thermostats or thermal overloads normally found in thermally protected motors, or space heaters that might have high surface temperatures.

In essence, what the code is saying is that three phase induction motors that do not have high temperature surfaces or sparking parts will not, in normal operation, be likely to ignite the surrounding environment. They can be used because the likelihood of a (spark producing) failure of the motor occurring at the same time that a spill or accident occurs is so remote it is a very unlikely event.

One way to avoid conflicts on interpretations of what is needed is to “play safe” and use hazardous location motors for both Division 1 and Division 2 requirements. This is a safe but expensive option and becomes more expensive as motors get larger.

A second choice is to use three phase TEFC or even Open Drip Proof motors that meet the non-sparking and no hot surfaces requirements for Division 2.

For machinery builders or contractors who want to use the less expensive motors for Division 2 requirements, it is always wise to make your intentions known to the customer in advance.

Perhaps the best way to do this would be to notify them by letter, with a statement such as follows:

“Since your stated requirement is Class \_\_\_\_\* Group \_\_\_\_\*, Division 2, it is our intention to supply totally enclosed, fan cooled, three phase induction motors in accordance with Paragraph  (1)  of the National Electric Code. If you object to this, please notify us as soon as possible.”

By using this type of letter to make your intentions clear, it is much less likely that a dispute over interpretation will develop at a later time.

If you should have any questions regarding this requirement, please refer to the National Electric Code for the appropriate Section based on the class, group and division of the requirement.

\*  Fill in appropriate references

(1) Paragraph references

For Class I ----- 501-8(b)

For Class II ----- 502-8(b)

When using motors in Division 2 areas with an inverter power supply, refer to comments on page 96-97.



# DC DRIVE FUNDAMENTALS

## UNDERSTANDING DC DRIVES

DC motors have been available for nearly 100 years. In fact the first electric motors were designed and built for operation from direct current power.

AC motors are now and will of course remain the basic prime movers for the fixed speed requirements of industry. Their basic simplicity, dependability and ruggedness make AC motors the natural choice for the vast majority of industrial drive applications.

Then where do DC drives fit into the industrial drive picture of the future?

In order to supply the answer, it is necessary to examine some of the basic characteristics obtainable from DC motors and their associated solid state controls.

1. Wide speed range.
2. Good speed regulation.
3. Compact size and light weight (relative to mechanical variable speed).
4. Ease of control.
5. Low maintenance.
6. Low cost.

In order to realize how a DC drive has the capability to provide the above characteristics, the DC drive has to be analyzed as two elements that make up the package. These two elements are of course the motor and the control. (The “control” is more accurately called the “regulator”).

## DC MOTORS

Basic DC motors as used on nearly all packaged drives have a very simple performance characteristic — the shaft turns at a speed almost directly proportional to the voltage applied to the armature. Figure 1 shows a typical voltage/speed curve for a motor operating from a 115 volt control.

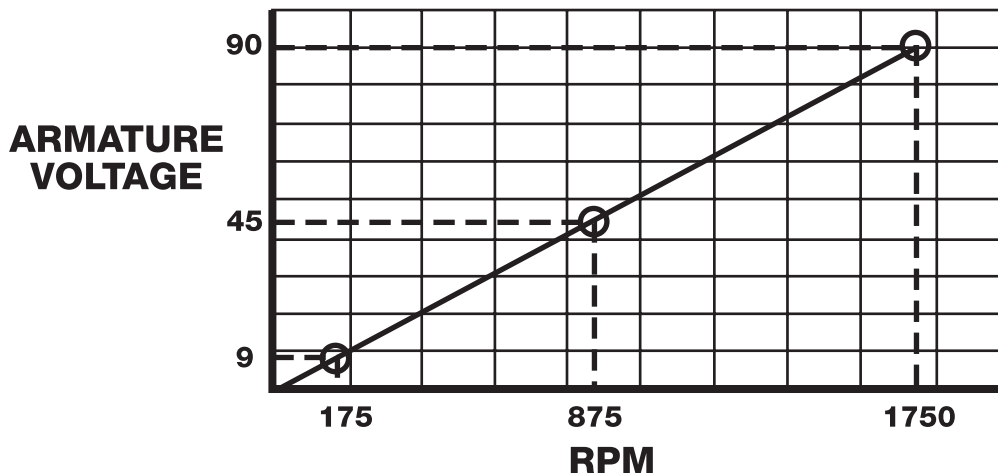

**FIGURE 1**

From the above curve you can see that with 9 volts applied to the armature, this motor would be operating at Point 1 and turn at approximately 175 RPM. Similarly with 45 volts applied, the motor would

be operating at Point 2 on the curve or 875 RPM. With 90 volts applied, the motor would reach its full speed of 1750 RPM at point 3.

From this example a general statement can be made that DC motors have “no load” characteristics that are nearly a perfect match for the curve indicated in Figure 1.

However, when operated at a fixed applied voltage but a gradually increasing torque load, they exhibit a speed droop as indicated in Figure 2.

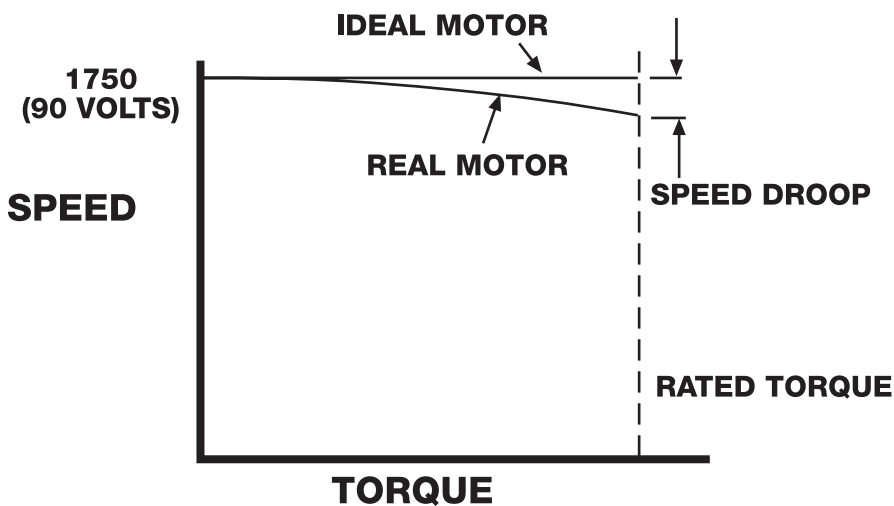

**FIGURE 2**

This speed droop is very similar to what would occur if an automobile accelerator pedal was held in a fixed position with the car running on level ground. Upon starting up an incline where more driving torque would be needed, the car would slow down to a speed related to the steepness of the hill. In a real situation, the driver would respond by depressing the accelerator pedal to compensate for the speed loss to maintain a nearly constant speed up the incline.

In the DC drive a similar type of “compensation” is employed in the control to assist in maintaining a nearly constant speed under varying load (torque) conditions.

The measurement of this tendency to slow down is called **Regulation** and is calculated with the following equation:

$$\% \text{ Regulation} = \frac{\text{No Load Speed} - \text{Full Load Speed}}{\text{No Load Speed}} \times 100$$

In DC drives the regulation is generally expressed as a percentage of motor base speed.

If the control (regulator) *did not* have the capability of responding to and compensating for changing motor loads, regulation of typical motors might be as follows:

HP	% MOTOR REGULATION	HP	% MOTOR REGULATION
1/4	13.6	1.5	8.0
1/3	12.9	2	7.2
1/2	13.3	3	4.2
3/4	10.8	5	2.9
1	6.7	7.5	2.3

One other very important characteristic of a DC motor should be noted. Armature amperage is almost directly proportional to output torque regardless of speed. This characteristic is shown by Figure 3. Point 1 indicates that a small fixed amount of current is required to turn the motor even when there is no output torque. This is due to the friction of the bearings, electrical losses in the motor materials and load imposed by the air in the motor (windage).

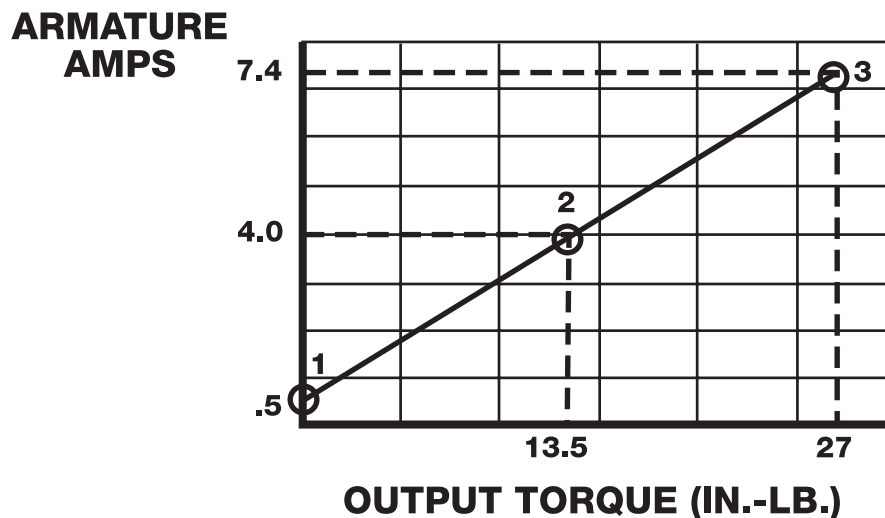

**FIGURE 3**

Beyond Point 1 through Point 2 and 3, the current increases in direct proportion to the torque required by the load.

From this discussion and Figure 3 a general statement can be made that for PM and Shunt Wound motors **load torque determines armature amperage.**

In summary, two general statements can be made relative to DC motor performance.

1. **Motor Speed** is primarily determined by **Applied Armature Voltage.**
2. **Motor Torque** is controlled by **Armature Current** (amperes).

Understanding these two concepts of DC motors provides the key to understanding total drive performance.

### **REGULATORS (CONTROLS)**

The control provides two basic functions:

1. **It rectifies** AC power converting it to DC for the DC motor.
2. **It controls** the DC output voltage and amperage in response to various control and feedback signals thereby regulating the motor's performance, both in speed and torque.

### **RECTIFYING FUNCTION**

The basic rectifying function of the control is accomplished by a combination of power semiconductors (Silicon Controlled Rectifiers and Diodes) that make up the "power bridge" assembly.

## REGULATING FUNCTION

The regulating function is provided by a relatively simple electronic circuit that monitors a number of inputs and sums these signals to produce a so called "error" signal. This error signal is processed and transformed into precisely timed pulses (bursts of electrical energy). These pulses are applied to the gates of the SCR's in the power bridge thereby regulating the power output to the DC motor.

For most purposes it is not necessary to understand the electronic details of the regulator, however, in order to appreciate the regulator function it is good to understand some of the input signals that are required to give the regulator its capabilities, these are shown diagrammatically in Figure 4.

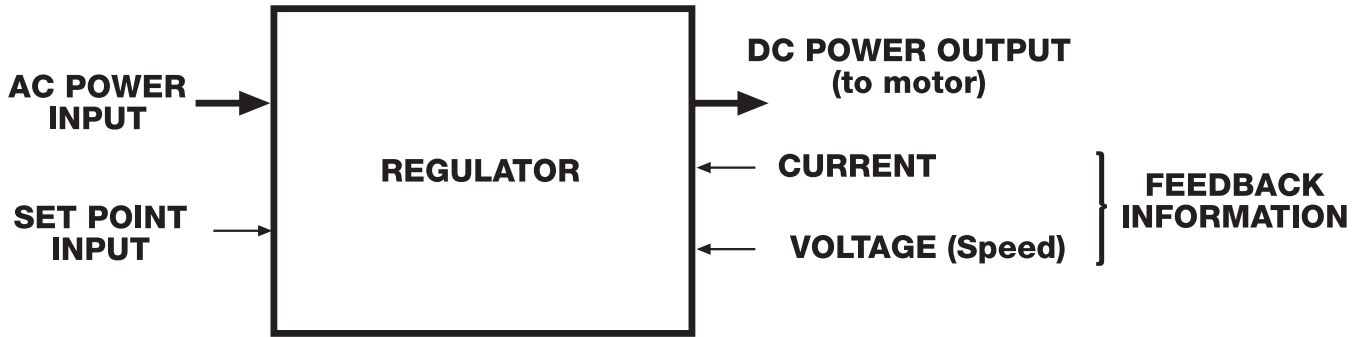

**FIGURE 4**

The AC to DC power flow is a relatively simple straight through process with the power being converted from AC to DC by the action of the solid state power devices that form the power bridge assembly.

The input and feedback signals need to be studied in more detail.

## SET POINT INPUT

In most packaged drives this signal is derived from a closely regulated fixed voltage source applied to a potentiometer. 10 volts is a very common reference.

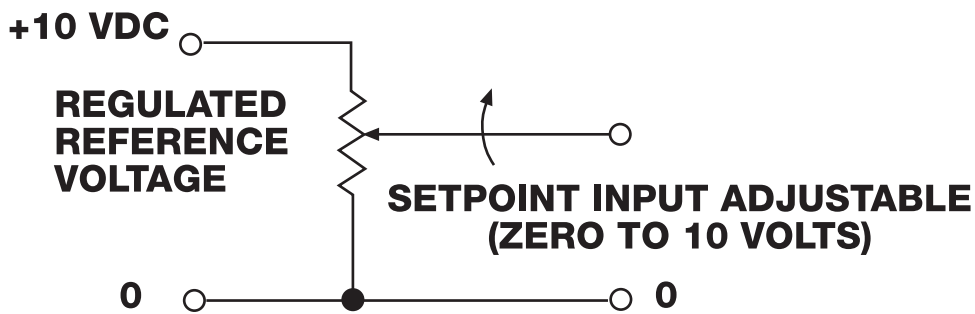

**FIGURE 5**

The potentiometer has the capability of accepting the fixed voltage and dividing it down to any value of from, for example, 10 to zero volts, depending on where it is set. A 10 volt input to the regulator from the speed adjustment control (potentiometer) corresponds to maximum motor speed and zero volts corresponds to zero speed. Similarly any speed between zero and maximum can be obtained by adjusting the speed control to the appropriate setting.

## **SPEED FEEDBACK INFORMATION**

In order to “close the loop” and control motor speed accurately it is necessary to provide the control with a feedback signal related to motor speed.

The standard method of doing this in a simple control is by monitoring the armature voltage and feeding it back into the regulator for comparison with the input “set point” signal.

When armature voltage becomes high, relative to the set point, established by the speed potentiometer setting, an “error” is detected and the output voltage from the power bridge is reduced to lower the motor’s speed back to the “set point”. Similarly when the armature voltage drops an error of opposite polarity is sensed and the control output voltage is automatically increased in an attempt to re-establish the desired speed.

The “Armature Voltage Feedback System” which is standard in most packaged drives is generally called a “Voltage Regulated Drive”.

A second and more accurate method of obtaining the motor speed feedback information is called “Tachometer Feedback”. In this case the speed feedback signal is obtained from a motor mounted tachometer. The output of this tachometer is directly related to the speed of the motor. Using Tachometer Feedback generally gives a drive improved regulation characteristics. When “tach feedback” is used the drive is referred to as a “Speed Regulated Drive”. Most controls are capable of being modified to accept tachometer signals for operation in the tachometer feedback mode.

In some newer high performance “digital drives” the feedback can come from a motor mounted encoder that feeds back voltage pulses at a rate related to motor speed. These (counts) are processed digitally being compared to the “set point” and error signals are produced to regulate the armature voltage and speed.

## **CURRENT FEEDBACK**

The second source of feedback information is obtained by monitoring the motor armature current. As discussed previously, this is an accurate indication of the torque required by the load.

The current feedback signal is used for two purposes:

1. As positive feedback to eliminate the speed droop that occurs with increased torque load on the motor. It accomplishes this by making a slight corrective increase in armature voltage as the armature current increases.
2. As negative feedback with a “threshold” type of control that limits the current to a value that will protect the power semiconductors from damage. By making this function adjustable it can be used to control the maximum torque the motor can deliver to the load.

The current limiting action of most controls is adjustable and is usually called “Current Limit” or “Torque Limit”.

In summary, the Regulator accomplishes two basic functions:

1. It converts the alternating Current to Direct Current.
2. It regulates the armature voltage and current to control the speed and torque of the DC Motor.

## TYPICAL ADJUSTMENTS

In addition to the normal external adjustment such as the speed potentiometer, there are a number of common internal adjustments that are used on simple small analog type SCR Drives. Some of these adjustments are as follows:

- Minimum Speed
- Maximum Speed
- Current Limit (Torque Limit)
- IR Compensation
- Acceleration Time
- Deceleration Time

The following is a description of the function that these individual adjustments serve and their typical use.

### MINIMUM SPEED

In most cases when the control is initially installed the speed potentiometer can be turned down to its lowest point and the output voltage from the control will go to zero causing the motor to stop. There are many situations where this is not desirable. For example there are some machines that want to be kept running at a minimum speed and accelerated up to operating speed as necessary. There is also a possibility that an operator may use the speed potentiometer to stop the motor to work on the machine. This can be a dangerous situation since the motor has only been brought to a stop by zeroing the input signal voltage. A more desirable situation is when the motor is stopped by opening the circuit to the motor or power to the control using the on/off switch. By adjusting the minimum speed up to some point where the motor continues to run even with the speed potentiometer set to its lowest point, the operator must shut the control off to stop the motor. This adds a little safety into the system. The typical minimum speed adjustment is from 0 to 30% of motor base speed.

### MAXIMUM SPEED

The maximum speed adjustment sets the maximum speed attainable either by raising the input signal to its maximum point or turning the potentiometer to the maximum point. For example on a typical DC motor the rated speed of the motor might 1750 RPM but the control might be capable of running it up to 1850 or 1900 RPM. In some cases it's desirable to limit the motor (and machine speed) to something less than would be available at this maximum setting. The maximum adjustment allows this to be done. By turning the internal potentiometer to a lower point the maximum output voltage from the control is limited. This limits the maximum speed available from the motor. In typical controls such as our BC140 the range of adjustment on the maximum speed is from 50 to 110% of motor base speed.

### CURRENT LIMIT

One very nice feature of electronic speed controls is that the current going to the motor is constantly monitored by the control. As mentioned previously, the current drawn by the armature of the DC motor is related to the torque that is required by the load. Since this monitoring and control is available an adjustment is provided in the control that limits the output current to a maximum value.

This function can be used to set a threshold point that will cause the motor to stall rather than putting out an excessive amount of torque. This capability gives the motor/control combination the ability to prevent damage that might otherwise occur if higher values of torque were available. This is handy on machines that might become jammed or otherwise stalled. It can also be used where the control is operating a device such as the center winder where the important thing becomes torque rather than the speed. In this case the current limit is set and the speed goes up or down to hold the tension o the material being wound. The current limit is normally factory set at 150% of the motor's rated current. This allows the



motor to produce enough torque to start and accelerate the load and yet will not let the current (and torque) exceed 150% of its rated value when running. The range of adjustment is typically from 0 to 200% of the motor rated current.

### **IR COMPENSATION**

IR compensation is a method used to adjust for the droop in a motor's speed due to armature resistance. As mentioned previously, IR compensation is positive feedback that causes the control output voltage to rise slightly with increasing output current. This will help stabilize the motor's speed from a no-load to full load condition. If the motor happens to be driving a load where the torque is constant or nearly so, then this adjustment is usually unnecessary. However, if the motor is driving a load with a widely fluctuating torque requirement, and speed regulation is critical, then IR compensation can be adjusted to stabilize the speed from the light load to full load condition. One caution is that when IR compensation is adjusted too high it results in an increasing speed characteristic. This means that as the load is applied the motor is actually going to be forced to run faster. When this happens it increases the voltage and current to the motor which in turn increases the motor speed further. If this adjustment is set too high an unstable "hunting" or oscillating condition occurs that is undesirable.

### **ACCELERATION TIME**

The Acceleration Time adjustment performs the function that is indicated by its name. It will extend or shorten the amount of time for the motor to go from zero speed up to the set speed. It also regulates the time it takes to change speeds from one setting (say 50%) to another setting (perhaps 100%). So this setting has the ability to moderate the acceleration rate on the drive.

A couple notes are important: if an acceleration time that is too rapid is called for "acceleration time" will be overridden by the current limit. Acceleration will only occur at a rate that is allowed by the amount of current the control passes through to the motor. Also important to note is that on most small controls the acceleration time is not linear. What this means is that a change of 50 RPM may occur more rapidly when the motor is at low speed than it does when the motor is approaching the set point speed. This is important to know but usually not critical on simple applications where these drives are used.

### **DECELERATION TIME**

This is an adjustment that allows loads to be slowed over an extended period of time. For example, if power is removed from the motor and the load stops in 3 seconds, then the decel time adjustment would allow you to increase that time and "power down" the load over a period of 4, 5, 6 or more seconds. Note: On a conventional simple DC drive it will not allow for the shortening of the time below the "coast to rest" time.

### **ADJUSTMENT SUMMARY**

The ability to adjust these six adjustments gives great flexibility to the typical inexpensive DC drive. In most cases the factory preset settings are adequate and need not be changed, but on other applications it may be desirable to tailor the characteristics of the control to the specific application.

Many of these adjustments are available in other types of controls, such as variable frequency drives.



# HANDLING 50 HERTZ REQUIREMENTS

## INTRODUCTION

As American manufacturers increase exports to 50 hertz countries, there arises the problem of supplying motors for 50 hertz service at an array of unfamiliar voltages. Fortunately there are some possibilities available that make it feasible to handle many of these requirements without waiting for special designs.

The first choice should always be to utilize a stock 50 hertz motor from the wide variety offered in the current 501 catalog. If the basic motor exists but needs some type of modifications, they can frequently be handled through the Mod Express program to get exactly what is needed.

If a 50 Hz stock motor either doesn't exist or cannot be modified to match the requirement, then some other alternatives exist.

In order to provide a description of these alternatives, we must first break it into two major groups: Three Phase and Single Phase.

## THREE PHASE MOTORS

When three phase motors are required, the situation can be quite simple. One "Rule of Thumb" that comes in very handy is as follows:

**When the Ratio of Volts to Hertz Stays Constant, the Motor Can be Operated at the Reduced Frequency and Reduced Voltage.**

Under this condition, the motor will provide the same operating torque that it would provide at its 60 hertz frequency. Please note that the stipulation — **the same torque should be remembered**. An example may help illustrate the situation.

A standard induction motor rated at 1 HP, 3 phase, 230/460 volts, 60 hertz would be checked out as follows:  $460 \div 60 = 7.66$  volts per hertz. In this case, the matching 50 hertz voltage would be  $50 \times 7.66 = 383$  volts. Thus the standard 60 hertz motor could be used at 50 hertz on voltages of 190 or 380. Under this condition of reduced voltage and frequency, the motor could be expected to generate the same amount of torque as it would on the normal 60 hertz application. In this case, it would be 3 lb. ft. of torque.

The speed of the motor would of course be lower than it would be on 60 hertz. Normally, you would expect to get a speed that is roughly five-sixths of the 60 hertz speed. In the case of a 1725 RPM motor, you would normally be 1425 RPM when the motor is operated on a 50 hertz power system.

## WHAT ABOUT HORSEPOWER?

Since horsepower is the product of speed and torque, you would expect that the horsepower output would be five-sixths or slightly over 80 percent of the 60 hertz rating. In order to overcome this problem, there are two approaches: The first would be to select the next larger HP rating. Thus, in the example cited above, a 1-1/2 HP motor could be used to handle very nicely the 1 HP requirement at 50 hertz. In most cases, the incremental cost of selecting the next higher horsepower is substantially less than the cost and time involved in ordering a special unit. This derating approach is a sound and conservative one that can be used on virtually all applications involving open drip-proof and totally enclosed motors and brake motors. A motor selected in this manner can be nameplated to the new voltage, HP, speed and frequency combination.

Due to the inherent conservative designs used in Baldor motors and the normal voltage tolerances, many stock motors can be operated on 200 volts, 3 phase, 50 hertz or 400 volts, 3 phase, 50 hertz. Some can also be operated on 415 volt, 50 hertz systems. These combinations of 200, 380, 400 and 415 are the most frequently occurring 50 hertz voltages.

A second approach allows you to handle many of the 50 hertz requirements without derating. This is a little more involved and might normally be considered where special motors exist or where there are specific frame size restrictions that do not allow for an increase to the next larger HP rating.

The approach in this case involves asking a few specific questions and having a reasonable understanding of the type of load that is being driven. The basic question is this: "Is the machine going to be identical in all respects to its 60 hertz counterpart?" If the answer to that question is "yes", a second question should be asked as follows: "Are you going to allow your machine to run at five-sixths of the 60 hertz speed or are you going to change transmission components such as gearing, belts, pulleys, etc. to increase the output speed up to the normal rate that you would get if the motor were to be running on 60 hertz?" In this case, if the customer is going to change components in the machine to maintain the performance of the machine up to the 60 hertz capability, then the approach of oversizing, as discussed previously, should be used.

If, on the other hand, the machine is identical and the customer is going to operate it at reduced capability, then the torque required to drive the machine would normally be the same torque or in some cases less than the 60 hertz torque requirement. If the torque requirement is the same or less, then the motor need not be derated since the machine's requirements have been decreased and the motor would still be a perfect match for the machine. There are also many Baldor motors that can be operated at the rated horsepower on 50 hertz requirements without exceeding their rated temperature rise. Thus, a third option also exists but it involves a good deal more searching to determine if a motor can be utilized to handle specific requirements.

## **OTHER VOLTAGES**

Aside from the three commonly occurring 50 hertz voltages that have been described previously, there also arises from time to time requirements for others such as 440 volts, 50 hertz. When the rule of thumb is applied to standardly available motors, it turns out that this voltage is not one that can be handled by normal derating processes. In this instance, a special motor would have to be wound or an existing motor could be rewound by a service shop to match this requirement. In some instances, 575 volt, 60 hertz motors can be utilized to handle voltages of 480, 50 hertz or as high as 500 volts, 50 hertz. When this occurs, the normal procedures for derating as listed previously can be applied.

## **SINGLE PHASE MOTORS**

Single phase motors present a unique problem since there are two items involved:

1. The winding must match the 50 hertz frequency and voltage.
2. The centrifugal starting switch must be set to operate at the right point as the motor accelerates during its starting period.

The simultaneous requirement for both of these items usually makes it impossible to utilize normal 60 hertz motors for 50 hertz, single phase requirements. In most instances it may be possible to rewind an existing 60 hertz motor and change the centrifugal starting switch to one that is appropriate for 50 hertz operation. This procedure is fairly costly and time consuming.

A second option exists with Baldor motors since we now offer a good selection of single phase, 50 hertz motors in the range of horsepowers of from 1/3 to 5. These motors are specifically designed for 50 hertz operation on either 110 volts or 220 volts (5 HP, 220 volts only). They are rigid base motors in both open drip proof and totally enclosed. When C Flanges are required, footless C Face 1425 and 2850 RPM

motors are offered in a range of sizes from 1/3 to 2 HP. C Flange kits are available to convert stock motors from the standard mounting to a C Flange mounting. Since the bases are welded on, it is not feasible to remove the base in order to get a footless motor but most customers will not object to having both the C Flange and rigid base if they can get availability of the basic unit.

### **EXPLOSION PROOF MOTORS**

Explosion proof motors present some unique problems. Basically, they conform to the same rules that have been discussed previously. However, due to the UL (Underwriters Laboratory), many of these motors cannot be renameplated to alternate voltages or frequency. The reason for this hinges on the safety aspects of the explosion proof designs as well as the thermal overload coordination situation. Thus, explosion proof, 50 hertz motors, that are not available from stock, both single and three phase, have to be ordered as special units.

Many three-phase Baldor explosion proof motors are already supplied with a 50/60 Hz nameplate.

### **SUMMARY**

By using the techniques described, it is possible to handle a very high percentage of the normally occurring 50 hertz voltage requirements. If you should have questions, please contact us and we will try to be of assistance.



# OPERATING MOTORS IN WET OR DAMP ENVIRONMENTS

When electric motors are installed in wet or damp areas, the life of the motor is almost always shortened from what would be expected in a dry situation. However, there are several cautions and suggestions that can extend the life of motors in these less than ideal situations.

## OPEN DRIP-PROOF MOTORS

Generally speaking, open drip-proof motors are not suitable for wet environments. However, there are many situations where an equipment manufacturer chooses the open drip-proof motor (probably because of its lower first cost) for use where a totally enclosed motor would have been a better and longer life choice. If an open drip-proof motor is in place, a few suggestions can help extend motor life.

First, the motor should be shielded from the direct impact of rain, fog, snow, etc. In shielding a motor from the elements, caution should be used not to restrict air flow to and around the motor. Thus, putting a shelter over the motor is a fine idea, as long as the shelter is well ventilated or louvered so that hot air is not trapped inside.

Next, it is important to realize that open drip-proof motors are built to be mounted with a certain orientation. For example, many open drip-proof motors have “venetian blind” type louvers in the end housings to make water that is falling from above deflect away from the inside of the motor. This works fine except when motors get mounted to a wall or with feet up (ceiling mounting). In the ceiling mounted case, unless the position of the end housings is changed relative to the base of the motor, the louvers will have a funnel effect directing rain, snow and other debris into the windings to shorten the life of the motor. In these cases, end housings should be rotated to put the louvers in the proper position to fend off rain rather than funneling it inside.

The use of open drip-proof motors outdoors or in wet areas is not ideal. In the event of a failure, the motor should be replaced with a motor more suitable for an outdoor or wet environment.

## TOTALLY ENCLOSED FAN COOLED

Totally enclosed fan cooled motors are more adaptable to outdoor and high moisture areas and with a bit of caution, they will work well. The following suggestions will help extend the life of totally enclosed motors.

Totally enclosed fan cooled motors have “weep holes” at the bottom of the end housings. Weep holes or fittings are put there to allow condensation or other accumulations of moisture to drain. At times, motors are mounted in unusual positions such as with the shaft horizontal but with the base mounted on a vertical wall. In this case the weep holes are out of position by 90 degrees and the only time they could do their job would be when the motor is half full of water. This, of course, is unacceptable. When motors are going to be used in different positions, care should be taken to reposition the end brackets so the weep holes are at the lowest point of the motor. This is especially important in applications such as the brush drives used in car washes and similar situations where water is apt to be falling on the motors continuously. In this situation some water can always be expected to enter the motor. The key to extending motor life is to give it an easy way out. On motors that are mounted at odd angles where the weep holes cannot be properly re-positioned to the lowest point, the problem can be remedied by carefully drilling a small hole at the lowest point. Caution must be taken to be sure power to the motor is disconnected and the drill bit does not touch or damage the windings or motor bearings.

Motors such as the Baldor “Washdown Duty™”, “Dirty Duty®” and “Severe Duty” are designed to seal the motor and prevent the entrance of moisture. However, try as we might, it is nearly impossible to keep all water out. Thus, it is vitally important that the weep holes be positioned so that water entering the motor either by direct impingement or by exchange of air saturated with dampness, can drain away freely rather than accumulating.

One other source of water in a motor is condensation that can occur as a result of repeated heating and cooling cycles. For example, when the motor gets hot, the air within the motor expands and pushes out. Later, when the motor cools, fresh moisture laden air will be drawn in as the air contracts. As this cycle repeats again and again, substantial quantities of water can accumulate. If left unchecked, it will lead to insulation failure.

Again, this highlights the importance of having the weep holes properly positioned so that water can drain before it accumulates in sufficient quantities to damage the motor.

Where motors run continuously, the heat generated in the motor by normal operation can keep windings dry. But when a motor is used infrequently and is subject to large swings in temperature, there are two methods which can be used to reduce the susceptibility to failure caused by accumulated moisture.

The first and most popular method is the use of heaters installed within the motor. In this case, cartridge heaters or silicon rubber strip heaters, are placed within the motor and are turned on during the non-operating periods. The object of this method is to maintain the temperature inside the motor approximately five to ten degrees warmer than the surrounding air. When this is done, condensation inside the motor is prevented and the motor will stay dry. The heater method is similar to the way light bulbs are used in closets where the climate is humid to prevent mildew on clothing and leather goods.

When internal heaters are used, they are interconnected with the motor starter to turn on when the motor is not running and off when the motor is running.

The second method of accomplishing the same result is a system called "trickle heating". In this case, a source of low voltage single phase power is applied to the three phase motor windings when the motor is at rest. This results in a low energy, single phasing condition that produces heat in the windings, rotor, and indirectly the shaft and the bearings of the motor. This system is a good one for preventing condensation in motors that are at rest. Trickle heating is particularly good where there are groups of identical motors such as those used on aerators in pollution control lagoons.

### **HAZARDOUS LOCATION**

One of the most difficult motors to protect in wet and damp environments is hazardous location or explosion proof. The difficulty in protecting these motors arises from several factors. First, due to explosion proof design requirements, gaskets cannot be used. Similarly, the joints between the end housings and the frame and the conduit box and frame cannot be gasketed or sealed. There must be metal-to-metal contact along these joints. This metal-to-metal contact is close fitting but nonetheless, it cannot seal completely. Also, in explosion proof designs, it is not possible to use normal weep holes. Thus, when explosion proof motors get used in wet environments, moisture that gets inside the motor can accumulate and stay there for extended periods of time. There are breather drain devices that are used in some motors such as the Baldor 1.15 service factor Class 1, Group D explosion proof motors. These specially designed breather drains allow moisture to drain from the motor while still retaining the explosion proof integrity. Again, as in the case of other motors with weep holes, care must be taken to make sure that the breather drains are at the lowest point on the motor.

Some of the options that are available to control moisture in explosion proof motors are the same as those used in totally enclosed motors. Space heaters can be installed in the motors to keep the internal temperature of the motor above the outside temperature during idle periods. This is an effective way to control the build-up of condensation.

One further key to protecting explosion proof motors, especially in outdoor situations, is to shelter them from direct rainfall. Again, as in the case of other motors, the sheltering must be done so that it protects the motor but does not restrict the air flow to and around the motor from the outside.



## SUMMARY

The installation of motors in outdoor, wet, or damp environments presents some unique problems but, by the proper choice of motor and some caution in installation, most situations can be successfully handled to yield good, long term operating results. The proper choice of motor enclosure and features followed closely by the proper location of the weep holes and in some cases, use of an auxiliary heating device or system to warm the motor during non-operating time, will result in an effective life-extending -solution.

Motors such as the Baldor Washdown Duty™ and Severe Duty motors are specifically designed to handle difficult situations but even when using these specialized products, the basic cautions regarding proper orientation of the weep holes must be followed.





# BALDOR SALES OFFICES



## UNITED STATES

### ARIZONA

**PHOENIX**  
4211 S 43RD PLACE  
PHOENIX, AZ 85040  
PHONE: 602-470-0407  
FAX: 602-470-0464

### ARKANSAS

**CLARKSVILLE**  
706 WEST MAIN STREET  
CLARKSVILLE, AR 72830  
PHONE: 479-754-9108  
FAX: 479-754-9205

### CALIFORNIA

**LOS ANGELES**  
6480 FLOTILLA STREET  
COMMERCE, CA 90040  
PHONE: 323-724-6771  
FAX: 323-721-5859

### HAYWARD

21056 FORBES STREET  
HAYWARD, CA 94545  
PHONE: 510-785-9900  
FAX: 510-785-9910

### COLORADO

**DENVER**  
3855 FOREST STREET  
DENVER, CO 80207  
PHONE: 303-623-0127  
FAX: 303-595-3772

### CONNECTICUT

**WALLINGFORD**  
65 SOUTH TURNPIKE ROAD  
WALLINGFORD, CT 06492  
PHONE: 203-269-1354  
FAX: 203-269-5485

### FLORIDA

**TAMPA/PUERTO RICO/  
VIRGIN ISLANDS**  
3906 EAST 11TH AVENUE  
TAMPA, FL 33605  
PHONE: 813-248-5078  
FAX: 813-241-9514

### GEORGIA

**ATLANTA**  
62 TECHNOLOGY DRIVE  
ALPHARETTA, GA 30005  
PHONE: 770-772-7000  
FAX: 770-772-7200

### ILLINOIS

**CHICAGO**  
340 REMINGTON BLVD.  
BOLINGBROOK, IL 60440  
PHONE: 630-296-1400  
FAX: 630-226-9420

### INDIANA

**INDIANAPOLIS**  
5525 W. MINNESOTA STREET  
INDIANAPOLIS, IN 46241  
PHONE: 317-246-5100  
FAX: 317-246-5110

### IOWA

**DES MOINES**  
1943 HULL AVENUE  
DES MOINES, IA 50313  
PHONE: 515-263-6929  
FAX: 515-263-6515

### MARYLAND

**BALTIMORE**  
7071A DORSEY RUN RD  
ELKCRIDGE, MD 21075  
PHONE: 410-579-2135  
FAX: 410-579-2677

### MASSACHUSETTS

**BOSTON**  
6 PULLMAN STREET  
WORCESTER, MA 01606  
PHONE: 508-854-0708  
FAX: 508-854-0291

### MICHIGAN

**DETROIT**  
5993 PROGRESS DRIVE  
STERLING HEIGHTS, MI 48312  
PHONE: 586-978-9800  
FAX: 586-978-9969

### MINNESOTA

**MINNEAPOLIS**  
13098 GEORGE WEBER DR, SUITE 400  
ROGERS, MN 55374  
PHONE: 763-428-3633  
FAX: 763-428-4551

### MISSOURI

**ST LOUIS**  
13678 LAKEFRONT DRIVE  
EARTH CITY, MO 63045  
PHONE: 314-373-3032  
FAX: 314-373-3038

### KANSAS CITY

9810 INDUSTRIAL BLVD.  
LENEXA, KS 66215  
PHONE: 816-587-0272  
FAX: 816-587-3735

### NEW YORK

**AUBURN**  
ONE ELLIS DRIVE  
AUBURN, NY 13021  
PHONE: 315-255-3403  
FAX: 315-253-9923

### NORTH CAROLINA

**GREENSBORO**  
1220 ROTHERWOOD ROAD  
GREENSBORO, NC 27406  
PHONE: 336-272-6104  
FAX: 336-273-6628

### OHIO

**CINCINNATI**  
2929 CRESCENTVILLE ROAD  
WEST CHESTER, OH 45069  
PHONE: 513-771-2600  
FAX: 513-772-2219

### CLEVELAND

8929 FREEWAY DRIVE  
MACEDONIA, OH 44056  
PHONE: 330-468-4777  
FAX: 330-468-4778

### OKLAHOMA

**TULSA**  
5555 E. 71ST ST., SUITE 9100  
TULSA, OK 74136  
PHONE: 918-366-9320  
FAX: 918-366-9338

### OREGON

**PORTLAND**  
12651 SE CAPPS ROAD  
CLACKAMAS, OR 97015  
PHONE: 503-691-9010  
FAX: 503-691-9012

### PENNSYLVANIA

**PHILADELPHIA**  
103 CENTRAL AVENUE, SUITE 400B  
MOUNT LAUREL, NJ 08054  
PHONE: 856-840-8011  
FAX: 856-840-0811

### PITTSBURGH

159 PROMINENCE DRIVE  
NEW KENSINGTON, PA 15068  
PHONE: 724-889-0092  
FAX: 724-889-0094

### TENNESSEE

**MEMPHIS**  
4000 WINCHESTER ROAD  
MEMPHIS, TN 38118  
PHONE: 901-365-2020  
FAX: 901-365-3914

### TEXAS

**DALLAS**  
2920 114TH STREET SUITE 100  
GRAND PRAIRIE, TX 75050  
PHONE: 214-634-7271  
FAX: 214-634-8874

### HOUSTON

10355 W. LITTLE YORK ROAD  
SUITE 300  
HOUSTON, TX 77041  
PHONE: 281-977-6500  
FAX: 281-977-6510

### UTAH

**SALT LAKE CITY**  
2230 SOUTH MAIN STREET  
SALT LAKE CITY, UT 84115  
PHONE: 801-832-0127  
FAX: 801-832-8911

### WISCONSIN

**MILWAUKEE**  
1960 SOUTH CALHOUN ROAD  
NEW BERLIN, WI 53151  
PHONE: 262-784-5940  
FAX: 262-784-1215

## INTERNATIONAL SALES

**FORT SMITH, AR**  
P.O. BOX 2400  
FORT SMITH, AR 72902  
PHONE: 479-646-4711  
FAX: 479-648-5895

## CANADA

**EDMONTON, ALBERTA**  
4053-92 STREET  
EDMONTON, ALBERTA T6E 6R8  
PHONE: 780-434-4900  
FAX: 780-438-2600

## TORONTO

**OAKVILLE, ONTARIO**  
2910 BRIGHTON ROAD  
OAKVILLE, ONTARIO, CANADA L6H 5S3  
PHONE: 905-829-3301  
FAX: 905-829-3302

## MONTREAL, QUEBEC

5155 J-ARMAND BOMBARDIER  
SAINT-HUBERT, QUÉBEC  
CANADA J3Z 1G4  
PHONE: 514-933-2711  
FAX: 514-933-8639

## VANCOUVER,

**BRITISH COLUMBIA**  
1538 KEBET WAY  
PORT COQUITLAM,  
BRITISH COLUMBIA V3C 5M5  
PHONE 604-421-2822  
FAX: 604-421-3113

## WINNIPEG, MANITOBA

54 PRINCESS STREET  
WINNIPEG, MANITOBA R3B 1K2  
PHONE: 204-942-5205  
FAX: 204-956-4251

## MEXICO

**LEON, GUANAJUATO**  
KM. 2.0 BLVD. AEROPUERTO  
LEON, GUANAJUATO, CP37545  
MEXICO  
PHONE: +52 477 761 2030  
FAX: +52 477 761 2010



Baldor Electric Company • P.O. Box 2400 • Fort Smith, AR 72902-2400 U.S.A.  
Ph: (479) 646-4711 • Fax (479) 648-5792 • International Fax (479) 648-5895 • www.baldor.com