

# Technical data, main dimensions

## Design

- To relevant standards: IEC, VDE, DIN, ISO, EN
- Degree of protection IP55, cooling IC411
- Non Sparking to EN 60079-15
- Type of protection Exe to EN 60079-7
- Rated voltages from 2 to 11 kV
- Rated frequency 50 or 60 Hz
- Number of poles 2p=2 to 8 (higher number of poles on request)
- Construction IMB3 and IMV1 (others on request)

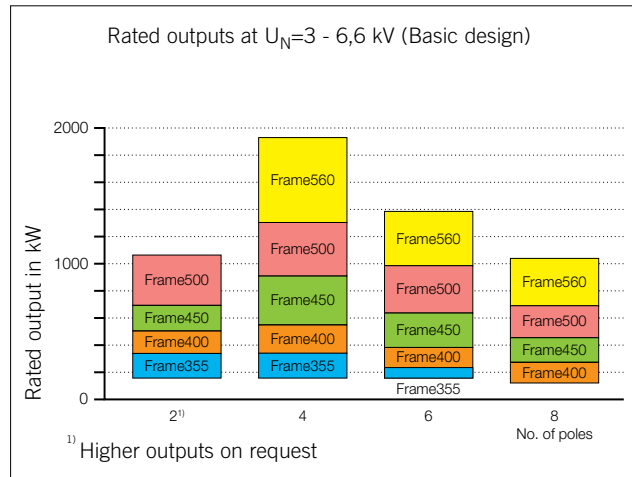

## Main dimensions at: 6kV, IMB3, Anti-friction bearings

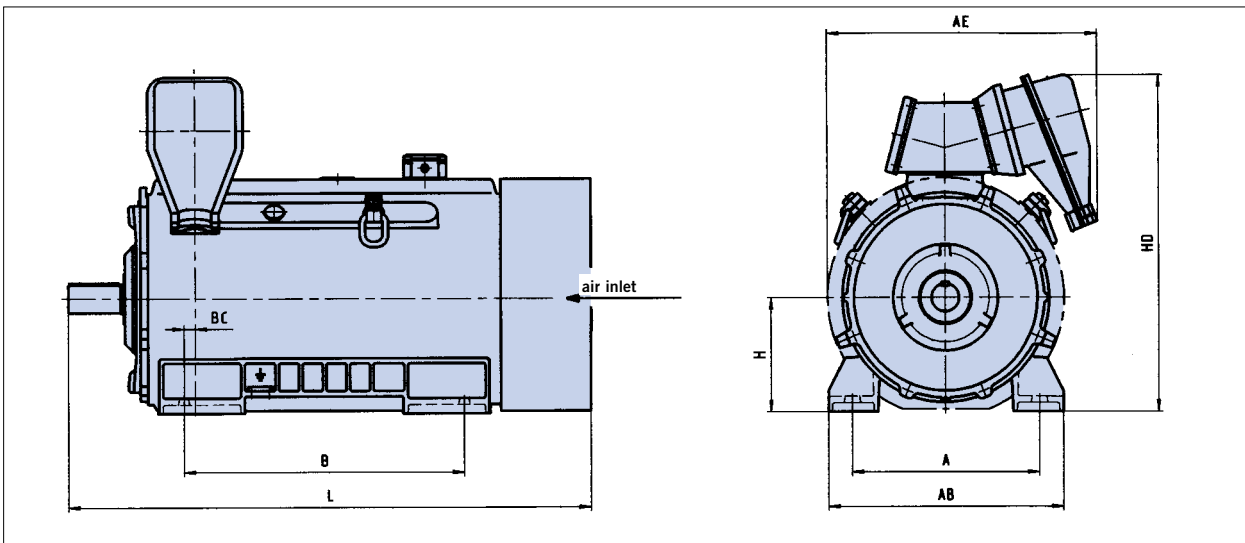

Dimensions in mm

Frame Size	No. of poles	A	AB	AE	B	BC	H	HD	L
355	2-8	610	730	870	900	70	355	1107	1785
400	2-8	686	810	950	1000	75	400	1207	1871
450	2-8	750	940	1080	1120	45	450	1327	2091
500	2 <sup>1)</sup> -8	850	1050	1140	1250	93	500	1435	2420
560	4-8	950	1160	1190	1400	93	560	1553	2645

<sup>1)</sup> 2p=2 with sleeve bearings only

## Terminals

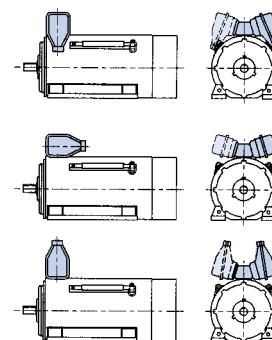

# Frame and corrosion protection

## Frame

Frame and endshields are made of cast iron. Motor feet are cast on. For each shaft centre height only one frame length is used.

**To ensure optimum use of material, the finite element method was used for the design. The frame design ensures the highest possible strength, torsional rigidity, and vibrostability.**

Segmental ribs and asymmetric arrangement of the terminal box make for a larger heat-radiating frame surface. In addition, cooling ribs are arranged on the frame inside around the endwindings.

Main and auxiliary terminal boxes are arranged on the cable duct on top of the frame. Cable entry can be from any direction.

D-end and N-end endshields are identical. Endshields are ribbed inside and out for increased mechanical strength and cooling, respectively.



FEM Frame volume model

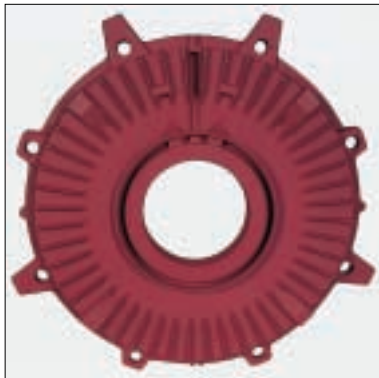

Enshield showing external ribs



Casting of a size 560 frame

## Corrosion protection

**Paint systems used by us are free from lead and other heavy metals, i. e. they are toxicologically harmless.**

Paint systems for long-term protection are chosen in accordance with site conditions to meet the requirements of climate groups **MODERATE** or **WORLDWIDE** to EN 60721.

### ■ Standard paint system for climate group MODERATE

Suitable for indoor and outdoor installation, normal industrial, non-corrosive atmospheres. Basis of finishing paint: Polyurethane resin

### ■ Special paint system for climate group WORLDWIDE

Suitable for outdoor installation in corrosive chemical atmospheres. Basis of finishing paint: Special plastics

**Both paint systems are resistant to light, resistant to temperatures up to 120°C, non-porous, elastic, and resistant to impact and abrasion.**

Prior to applying the high-quality primer, intermediate and finishing coats either by spraying or flooding, all cast iron parts are thoroughly sandblasted to ensure excellent keying of the coatings and hence a long-term corrosion protection.



## Anti-friction bearings

Our motors in basic design are fitted with Series 3 (medium) anti-friction bearings.

Exception: 2-pole frame 500 motors are always fitted with sleeve bearings.

IMB3 motors in basic design are provided at the D-end with a grooved ball bearing (locating) and at the N-end with a pre-loaded grooved ball bearing (non-locating).

**For particularly high radial loads, all motors are provided with a cylindrical roller bearing at the D-end.**

For lubrication, lithium-soap grease is used. All motors are fitted with standard lubricators M10x1. Outer bearing covers are designed to accommodate 5 years' quantity of spent grease.

The shaft seal on the bearing inside is a felt ring; on the bearing outside a labyrinth seal is used.

**Shaft seals are maintenance-free. They protect the bearings against the ingress of dust and spray water, to degree of protection IP55.**

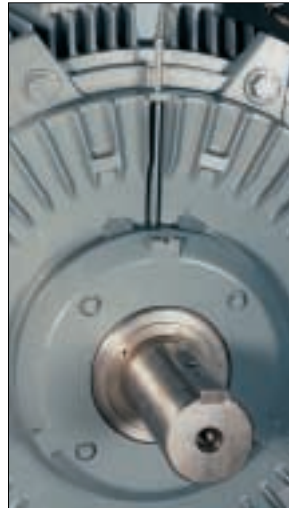

Anti-friction bearing with lubricator

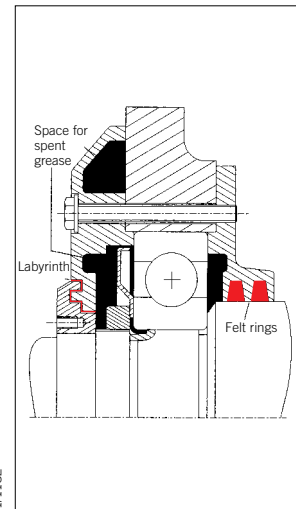

Shaft seals for anti-friction bearings



Self-lubricated sleeve bearing

## Sleeve bearings

On request, all motors can be fitted with sleeve bearings. (Sleeve bearings are always provided on 2-pole frame 500 motors). All sleeve bearings are of the split, flanged type.

**Depending on the bearing load in service, bearings with loose ring oilers (self lubrication) or with force-feed lubrication are used. Subsequent conversion from self to force-feed lubrication is possible.**

Sleeve bearings are non-locating. Shaft end float is  $\pm 3$  mm. On request, a locating bearing can be provided at the D-end.

**On the bearing inside, a floating labyrinth seal and a labyrinth ring is used. The shaft seal on the bearing outside consists of a floating labyrinth and an additional seal.**

Shaft seals are maintenance-free. They protect the bearings against the ingress of dust and spray water, to degree of protection IP55.

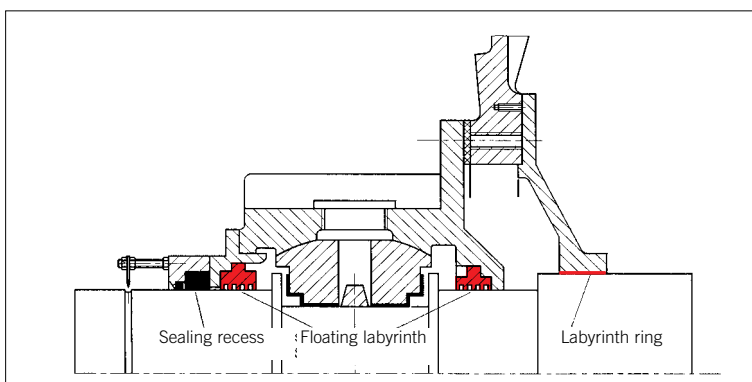

Shaft seals for sleeve bearings

## The ventilation system

This is characterised by the shape of the fan, the fan cowl, and the arrangement of the ribs, all combining to provide an optimum flow of cooling air. The uni-directional external fan is arranged at the N-end and is protected by a sheet-steel fan cowl. For internal cooling of core and endwindings, vanes are provided on the short-circuiting rings.

**The ventilation system ensures a uniformly low temperature level in the entire active part.**

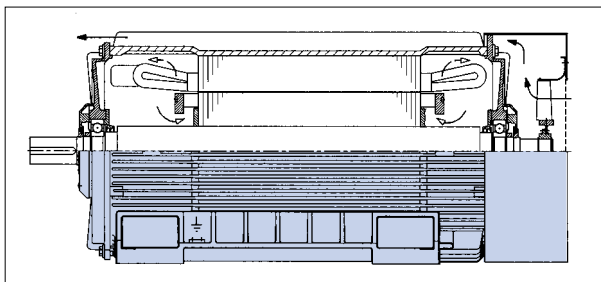

Cross-section showing air flow (Frame size 500)



Fan and fan cowl

## Noise

In view of ever more stringent regulations concerning protection of the environment and safety at work, the noise reduction of electrical machines is of particular importance.

**From the outset, i. e. already in the basic design, our machines are designed as low-noise machines. This is achieved by an interactive design of all components, such as:**

- Frame
- Ventilation System
- Electro-magnetic design
- Bearings

**For extreme low-noise requirements, additional noise reduction measures can be taken.**

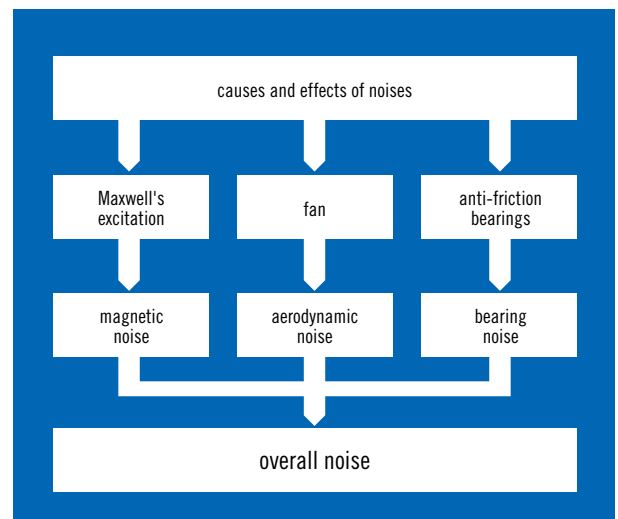
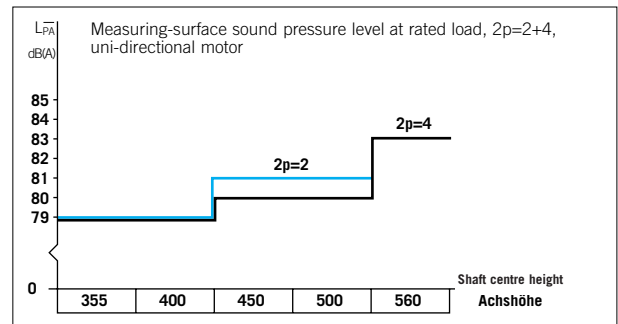

Sources of noise in electrical machines

Developments in the field of insulation led in the 80's to the introduction of the V-Celastik® insulating system. This is a system using the VPI technique which also corresponds to Class F.

**VPI means that the complete stator (core and windings) is impregnated with artificial resin in a vacuum/pressure process. The result is a winding with excellent thermal, electrical and mechanical properties.**

**The constantly high quality of the high-voltage insulation is ensured by the latest in manufacturing equipment.**

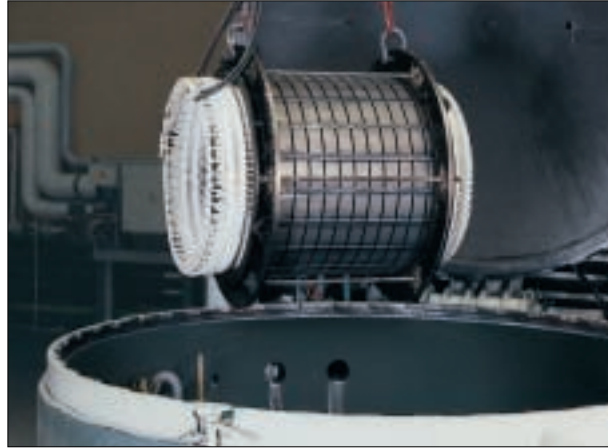

Wound stator prior to impregnation

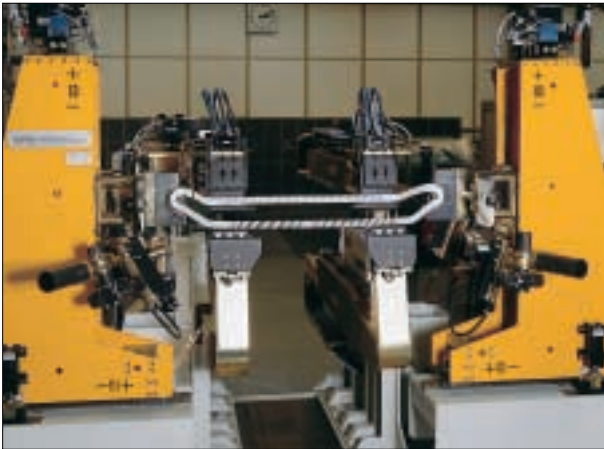

Coil-spreading machine

## Impulse withstand capability

The impulse withstand level of the windings is well above the specified minimum of 4 xUN + 5 kV so that additional protective measures against overvoltages have to be taken only in exceptional cases.

## Mechanical stability

Windings are designed to meet all mechanical stresses occurring in service. The bracing of each winding is calculated, using a special computer program developed at Hanover University.

**This calculation is based on the highest stresses to be expected, e. g. reconnection against 100 % residual voltage in phase opposition.**

## Quality assurance

The manufacture of windings is, as is the entire company, subject to a certified QA system to DIN EN ISO 9001.

**Materials, manufacturing techniques and processes are continually monitored and the results recorded. Additional tests on winding elements, or complete windings, can be carried out on request.**

® Registered Trademark



Coil-taping machine



## Squirrel-cage rotor

In the basic design, the deep-bar squirrel-cage winding consists of copper bars, brazed to short-circuiting rings. Depending on rotor stresses, either butt or grooved bar-to-ring joints are used.

**The comparatively low resistance of the copper winding results in low current/heat losses and, consequently, in high efficiencies.**

The copper bars are driven into the core slots and peened to ensure absolutely positive seating. This prevents any movement of the cage winding and makes for optimum heat transfer, essential for long acceleration or locked-rotor times.

**For higher starting torques, or to meet the requirements of particular torque characteristics, special slot designs can be used.**

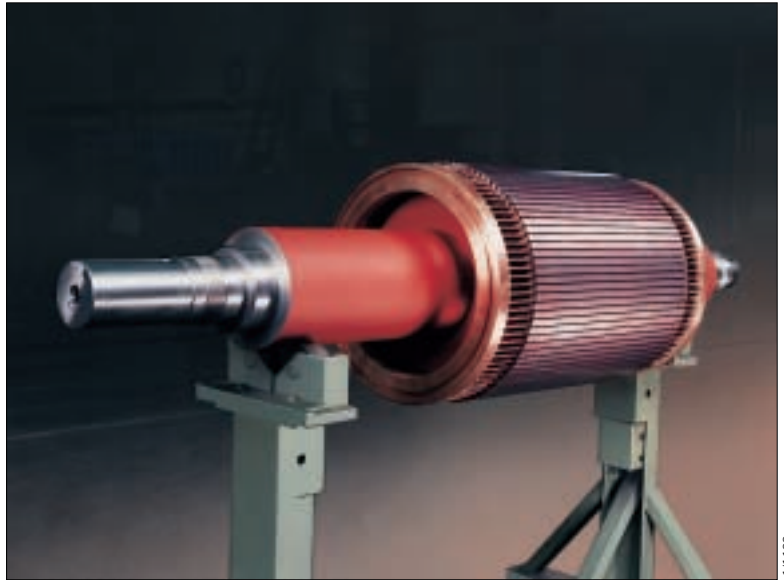

Rotor with copper cage winding

1/1133

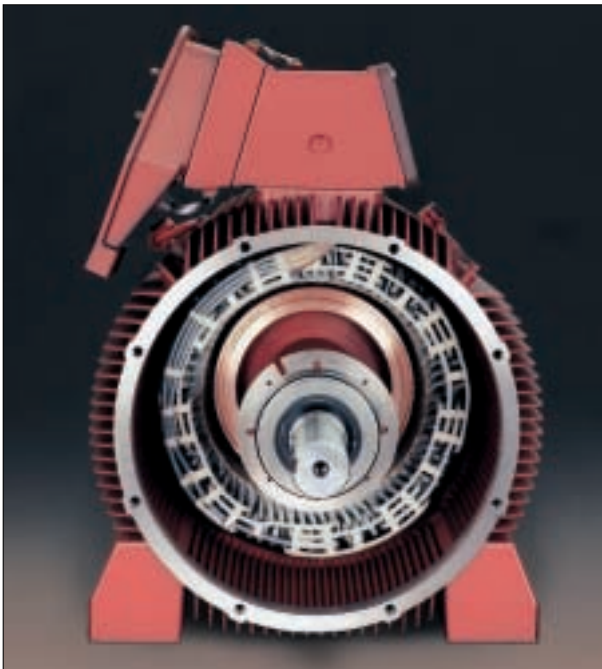

Connecting side of endwinding

1/1134

## Stator winding

The stator winding is a corded two-layer winding. It is connected in star, with the neutral being connected at the winding overhang. The three winding ends are brought out to the terminal box.

**The terminal box can be shifted subsequently from left to right or vice versa, without any problems, even at site.**

On request, all winding ends can be brought out. In that case, the neutral is formed in a separate terminal box.

## Operator protection

Terminal boxes have a high short-circuit strength (terminals) and are highly short-circuit-proof (shatterproof).

**In the event of a fault, the internal pressure is vented in one direction only. Injuries due to flying debris are prevented.**

**These properties have been verified in a neutral test laboratory in numerous internal fault tests on an infinite bus.**

## Electrical and mechanical design

Ample dimensions of the terminal boxes make for simple and safe connection of the supply cables. For the connection, either cable lugs (standard) or terminal clamps (special) are provided. Compoundfilled cable entries are available on request.

Terminal boxes meet the requirements of degree of protection IP54 to IEC 60529 and protection Ex eII EN 60079-7. All terminal boxes are designed for outdoor installation.

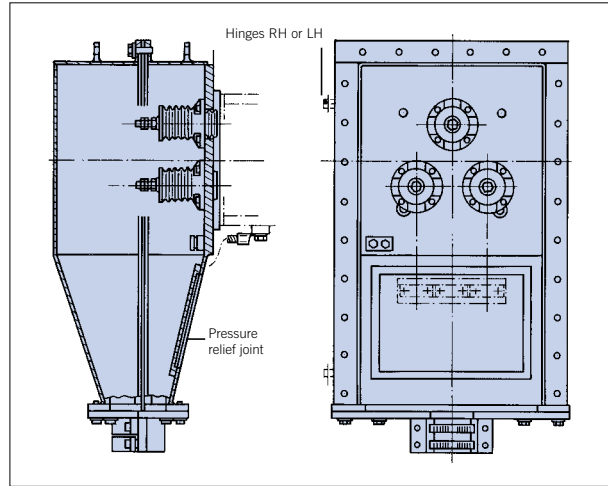

Terminal Box for 10 kV and for fault levels 330 or 800 MVA. Relief joint at the rear



Standard 6 kV terminal box with opened relief joint

1/0864



Terminal box with 6 kV cast-resin bushings

1/0866

In order to ensure the highest possible degree of safety, terminal boxes are made of non-splintering material. In addition, cast-resin bushings to DIN 46264 are used, which have a high bending and torsional strength. Pressure relief joints are arranged in such a way that an internal pressure is released either upwards or towards the machine.

Depending on the supply system, tested terminal boxes for the following fault capacities are available:

**200/350/400 MVA up to 6.6 kV or 330/800 MVA up to 11 kV**



Different terminal box designs

## Min. conductor cross-section

In order to ensure our safety concept, the following minimum conductor cross-sections must be observed:

System fault level	Min. cond. cross-section	
	Cu in mm <sup>2</sup> at U <sub>N</sub> =	
MVA	6kV	10kV
<200	70	70
>200-250	95	70
>250-350	150	95
>350-500	185	150
>500-800	-	185

On request, terminal plates can be provided for cable connectors IP66 for up to 11 kV and up to 400 A.