

# PRODUCT CATALOGUE

## PRESSURE TRANSMITTER



# PRESSURE AT THE HIGHEST LEVEL

„Successful medium-sized companies are not successful because they are active in many areas, but rather because they concentrate on one area and do it better than anyone else“

This is our philosophy. That´s why BDESENSORS has concentrated on electronic pressure measurement technology from the beginning.

With our unremitting product and quality strategy we have been successful in becoming a major player on the world market for electronic pressure sensing devices within a few years.

With 260 employees at 4 locations in Germany, the Czech Republic, Russia and China BD|SENSORS has solutions from 0.1 mbar to 6000 bar:

- pressure sensors, pressure transducers  
pressure transmitters

---

- electronic pressure switches

---

- pressure measuring devices with display and  
switching outputs

---

- hydrostatic level probes

---

Two pressure transmitters and a submersible probe, based on a stainless steel silicon sensor were the beginning. Today the range extends to more than 70 standard products, from economical OEM devices to high-end products with HART® communication or field bus interface.

In addition we have developed hundreds of customer-specific applications, underlining the competence and flexibility of BD|SENSORS. The excellent price/performance ratio of our products is proof of the fact that we are able to meet the toughest demand: Being a problem-solver for our customers.

## INDEX

<b>PRECISION</b>	5-34
PROCESS INDUSTRY	5-29
GENERAL INDUSTRIAL APPLICATION	30-34
<b>INDUSTRY</b>	35-104
GENERAL INDUSTRIAL APPLICATION	35-75
MARINE / OFFSHORE	76-89
PROCESS INDUSTRY	90-104
<b>OEM</b>	105-122
<b>SPECIAL VERSIONS</b>	123-131
<b>4 ADVANTAGES</b>	134
<b>ICONS</b>	135

For large production batches as well as for small production numbers, no matter for what medium or external factors, with almost any mechanical or electrical connection - we solve your problem

**flexibly, quickly and cost-efficiently.**

	pressure port / process connection			accuracy (FSQ) <sup>1</sup>	nominal pressure [bar]	options / special characteristics	pressure port / process connection						certificates	page		
	stainless steel sensor	ceramic sensor	DMS				inch and NPT threaded	inch thread flush	dairy pipe	Clamp (3A-certification)	Varivent® (3A-certification)	flange			DRD flange	
precision																
XMP i	•			0.1 %	0 ... 0.4 up to 0 ... 600	flameproof enclosure, cooling element up to 300°C	•	•					•	•	Ex, HART®	5-9
XMP ci		•		0.1 %	0 ... 0.06 up to 0 ... 20	flameproof enclosure	•	•					•	•	Ex, HART®	10-14
x act i	•			0.1 %	0 ... 0.4 up to 0 ... 40	hygienic version, cooling element up to 300°C			•	•	•	•	•	•	Ex, HART®, 3A	15-19
x act ci		•		0.1 %	0 ... 0.06 up to 0 ... 20	hygienic version			•	•	•	•	•	•	Ex, HART®	20-24
DMP 331Pi	•			0.1 %	0 ... 0.4 up to 0 ... 40	communication interface for adjustment of offset, span end damping			•	•	•				Ex	25-29
DMP 331i	•			0.1 %	0 ... 0.4 up to 0 ... 40	communication interface for adjustment of offset, span end damping	•								Ex	30-34
DMP 333i	•			0.1 %	0 ... 60 up to 0 ... 600	communication interface for adjustment of offset, span end damping	•								Ex	
industry																
DMP 343	•			0.35 %	0 ... 0.01 up to 0 ... 1	for non-aggressive gases	•								Ex, SIL, UL	35-39
DMP 331	•			0.35 %	0 ... 0.01 up to 0 ... 1	universal applications	•	•							Ex, SIL, UL	40-44
DMP 333	•			0.35 %	0 ... 60 up to 0 ... 600	universal applications	•								Ex, SIL, UL	45-49
DMP 339	•			0.35 %	0 ... 60 up to 0 ... 600	G 1/2" flush		•							Ex	50-53
DMP 335	•			0.5 %	0 ... 6 up to 0 ... 600	welded version	•								Ex, UL	54-58
DMP 334	•			0.35 %	0 ... 600 up to 0 ... 2.200	adjustability of span and offset	•								Ex, UL	59-62
DMP 304			•	0.5 %	0 ... 2,000 up to 0 ... 6,000	adjustability of span and offset	•								Ex	63-66
DMK 351		•		0.35 %	0 ... 0.04 up to 0 ... 20	diaphragm 99.9% Al2O3, pressure port PVDF	•								Ex	67-70
DMK 331		•		0.5 %	0 ... 0.4 up to 0 ... 600	pressure port PVDF for aggressive media	•								Ex, SIL, UL	71-75
DMP 457	•			0.35 %	0 ... 0.1 up to 0 ... 600		•	•							EX, DNV, GL, CCS	76-80
DMK 458		•		0.25 %	0 ... 0.04 up to 0 ... 20	diaphragm 99.9% Al2O3, seawater resistant pressure port	•								EX, DNV, GL, CCS	81-85
DMK 457		•		0.5 %	0 ... 0.4 up to 0 ... 600	seawater resistant pressure port	•								EX, DNV, GL, CCS	86-89
DMP 331 P	•			0.35 %	0 ... 0.1 up to 0 ... 40	hygienic version, cooling element up to 300°C			•	•	•				Ex, SIL, UL, 3A	90-94
DMK 331 P		•		0.5 %	0 ... 60 up to 0 ... 400	filling fluid with FDA approval, cooling element up to 300°C			•						Ex, SIL, UL	95-99
DMK 351 P		•		0.35 %	0 ... 0.04 up to 0 ... 20	diaphragm 99.9% Al2O3			•	•	•	•	•		Ex	100-104
OEM																
18.600 G	•			0.5 %	0 ... 0.1 up to 0 ... 6	for non-aggressive gases	•								UL	105-107
18.601 G	•			0.5 %	0 ... 0.1 up to 0 ... 6		•								UL	108-110
26.600 G		•		0.5 %	0 ... 1 up to 0 ... 400	oil and grease free version	•								UL	111-113
30.600 G		•		1 %	0 ... 1.6 up to 0 ... 250		•								UL	114-116
17.609 G	•			0.5 %	0 ... 6 up to 0 ... 60	welded version	•								UL	117-119
17.600 G	•			0.5 %	0 ... 6 up to 0 ... 600	welded version, suitable for oxygen	•								UL	120-122
special versions																
DMK 456		•		0.25 %	0 ... 0.04 up to 0 ... 20	diaphragm 99.9% Al2O3, seawater resistant pressure port	•						•		EX, DNV, GL, CCS	123-126
HU 300			•	0.5%	0 ... 5,000 psi up to 0 ... 15,000 psi	Hammer Union, pressure port WECO® 2"									Ex	127-131

<sup>1</sup> according to IEC 60770





# XMP i

## Precision Pressure Transmitter for the Process Industry with HART®-Communication

Stainless Steel Sensor

accuracy according to IEC 60770:  
0.1 % FSO

### Nominal pressure

from 0 ... 400 mbar up to 0 ... 600 bar

### Output signals

2-wire: 4 ... 20 mA  
others on request

### Special characteristics

- ▶ turn-down 1:10
- ▶ two chamber aluminium die cast case or stainless field housing
- ▶ internal or flush welded diaphragm
- ▶ HART®-communication
- ▶ IS-version: Ex ia = intrinsically safe for gases and dusts





### Optional versions

- ▶ IS-version: Ex d = flameproof enclosure
- ▶ integrated display and operating module
- ▶ special materials as Hastelloy® and Tantalum
- ▶ cooling element for media temperatures up to 300 °C

The process pressure transmitter XMP i has been especially designed for the process industry and measures vacuum, gauge and absolute pressure ranges of gases, steam, fluids up to 600 bar.

Different process connections such as threads and flanges with an internal or flush welded diaphragm are available and can be combined with a cooling element for media temperatures up to 300°C. The transmitter is as a standard equipped with HART®-communication; the customer can choose between a two chamber aluminum die cast case or a stainless field housing.

### Preferred areas of use are

-  Oil and gas industry
-  Chemical and petrochemical industry
-  Energy Industry
-  Heavy Industry



Pressure ranges <sup>1</sup>												
Nominal pressure gauge / abs. <sup>2</sup>	[bar]	0.4	1	2	4	10	20	40	100	200	400	600
Overpressure	[bar]	2	5	10	20	40	80	105	210	600	1000	1000
Burst pressure ≥	[bar]	3	7,5	15	25	50	120	210	420	1000	1250	1250

<sup>1</sup> On customer request we adjust the devices within the turn-down-possibility by software to the required pressure ranges.  
<sup>2</sup> absolute pressure possible from 1 bar

Vacuum ranges						
Nominal pressure gauge	[bar]	-0.4 ... 0.4	-1 ... 1	-1 ... 2	-1 ... 4	-1 ... 10
Overpressure	[bar]	2	5	10	20	40
Burst pressure ≥	[bar]	3	7,5	15	25	50

Output signal / Supply	
Standard	2-wire: 4 ... 20 mA IS-intrinsically safe version with HART <sup>®</sup> -communication / V <sub>S</sub> = 12 ... 28 V <sub>DC</sub>
Option	IS version flameproof enclosure / V <sub>S</sub> = 13 ... 28 V <sub>DC</sub>
Current consumption	max. 25 mA

Performance		
Accuracy <sup>3</sup>	≤ ± 0.1 % FSO	The accuracy is calculated as follows ≤ 0.1 + 0.015 x (turn-down - 5) % FSO e.g. turn-down 9: ≤ 0.1 + 0.015 x (9 - 5) % FSO = 0.16 % FSO
Performance after turn-down	- turn-down ≤ 1:5: no change - turn-down > 1:5:	
Permissible load	R <sub>max</sub> = [(V <sub>S</sub> - V <sub>Smin</sub> ) / 0.02 A] Ω	load during HART <sup>®</sup> communication: R <sub>min</sub> = 250 Ω
Influence effects	supply: 0.05 % FSO / 10 V	permissible load: 0.05 % FSO / kΩ
Long term stability	≤ ± 0.1 % FSO / year at reference conditions	
Response time	100 msec – without consideration of electronic damping	measuring rate 10/sec
Adjustability	electronic damping: 0 ... 100 sec	offset 0 ... 90 % FSO; turn-down of span up to 1:10

<sup>3</sup> accuracy according to IEC 60770 – limit point adjustment (non-linearity, hysteresis, repeatability)

Thermal errors / Permissible temperatures		
Tolerance band <sup>4,5</sup>	≤ 0.2 % FSO x turn-down (in compensated range -20 ... 85 °C)	
Permissible temperatures <sup>6</sup>	medium: -40 ... 125 °C for filling fluid silicon oil -10 ... 125 °C for filling fluid food compatible oil	without display: environment: -40 ... 80 °C storage: -40 ... 80 °C with display: environment: -20 ... 70 °C storage: -30 ... 80 °C
Permissible temperature medium for cooling element 300 °C	filling fluid silicon oil	overpressure: -40 ... 300 °C low pressure: -40 ... 150 °C filling fluid food compatible oil overpressure: -10 ... 250 °C low pressure: -10 ... 150 °C

<sup>4</sup> an optional cooling element can influence thermal effects for offset and span depending on installation position and filling conditions

<sup>5</sup> for flange- and DRD-version: tolerance band offset ≤ ± 1.6 % FSO / tolerance band span ≤ ± 0.6 % FSO

<sup>6</sup> max. temperature of the medium for nominal pressure gauge > 0 bar: 150 °C for 60 minutes with a max. environmental temperature of 50 °C (without cooling element).

Electrical protection	
Short-circuit protection	permanent
Reverse polarity protection	no damage, but also no function
Electromagnetic compatibility	emission and immunity according to EN 61326

Mechanical stability	
Vibration	5 g RMS (25 ... 2000 Hz) according to DIN EN 60068-2-6
Shock	100 g / 11 msec according to DIN EN 60068-2-27

Filling fluids	
Standard	silicon oil
Options for process connections	food compatible oil (with FDA approval) (Mobil DTE FM 32; Category Code: H1; NSF Registration No.: 130662) Halocarbon and others on request

Materials	
Pressure port	stainless steel 1.4404 (316L)
Housing	aluminium die cast, powder-coated or stainless steel 1.4404 (316L)
Cable gland	brass, nickel plated
Viewing glass	laminated safety glass
Seals (media wetted)	thread: standard: FKM option: FFKM (min. permissible temperature from -15 °C, possible for nominal pressure ranges P <sub>N</sub> ≤ 100 bar); others on request option: welded version for pressure ports according to EN 837 with P <sub>N</sub> between 1 and 40 bar DRD and flange: none, not included in the scope of delivery
Diaphragm Standard	stainless steel 1.4435 (316 L)
Options for process connections	Hastelloy <sup>®</sup> C-276 (2.4819), Tantalum (possible from 1 bar) on request
Media wetted parts	pressure port, seal, diaphragm

<b>Explosion protection</b>	
Approval AX12-XMP i	IBExU 05 ATEX 1106 X stainless steel field housing: zone 0: II 1G Ex ia IIC T4 Ga / II 1D Ex ia IIIC T85 °C Da aluminium die cast case: zone 1: II 2G Ex ia IIB T4 Gb / II 1D Ex ia IIIC T85 °C Da
Safety technical maximum values	$U_i = 28\text{ V}$ , $I_i = 93\text{ mA}$ , $P_i = 660\text{ mW}$ , $C_i = 0\text{ nF}$ , $L_i = 0\text{ }\mu\text{H}$ , $C_{\text{GND}} = 27\text{ nF}$
Approval AX17-XMP i (flameproof enclosure)	IBExU 12 ATEX 1045 X aluminium die cast case: zone 1: II 2G Ex d IIC T5 Gb
Permissible temperatures for environment	in zone 0: -20 ... 60 °C with $p_{\text{atm}}$ 0.8 bar up to 1.1 bar zone 1 or higher: -25 ... 70 °C (intrinsically safe version); -20 ... 70 °C (flameproof enclosure)
Connecting cables (by factory)	capacitance: signal line/shield also signal line/signal line: 160 pF/m inductance: signal line/shield also signal line/signal line: 1 $\mu\text{H/m}$

<b>Miscellaneous</b>	
Display (optionally)	LC-display, visible range 32.5 x 22.5 mm; 5-digit 7-segment main display, digit height 8 mm, range of indication $\pm 9999$ ; 8-digit 14-segment additional display, digit height 5 mm; 52-segement bargraph; accuracy 0.1% $\pm$ 1 digit
Ingress protection	IP 67
Installation position	any (standard calibration in a vertical position with the pressure port connection down; differing installation position have to be specified in the order)
Weight	min. 400 g (depending on housing and mechanical connection)
Operational life	> 100 x 10 <sup>6</sup> pressure cycles
CE-conformity	EMC Directive: 2004/108/EC Pressure Equipment Directive: 97/23/EC (module A) <sup>7</sup>

<sup>7</sup> This directive is only valid for devices with maximum permissible overpressure > 200 bar

### Wiring diagram

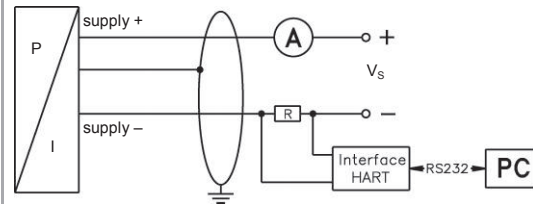

<b>Pin configuration</b>		
Electrical connections	<b>aluminium die cast case:</b> terminal clamps (clamp section: 2.5 mm <sup>2</sup> )	<b>stainless steel field housing:</b> terminal clamps (clamp section: 1.5 mm <sup>2</sup> )
Supply +	IN+	IN+
Supply -	IN-	IN-
Test	Test	-
Shield		

### Housing designs <sup>8</sup> (dimensions in mm)

#### aluminium die cast case

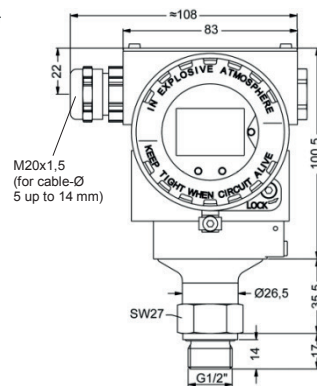
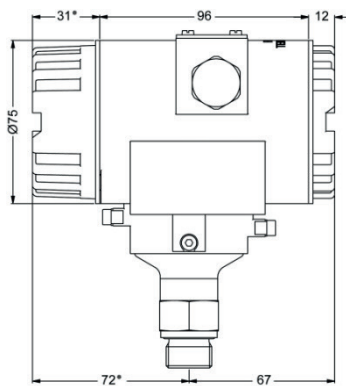

#### stainless steel field housing

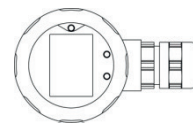
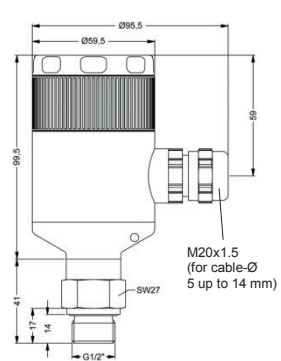
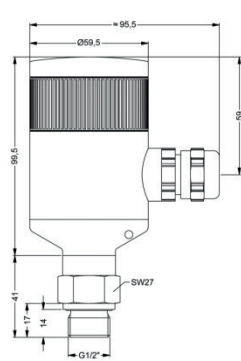

\* without display and operating module marked dimensions decrease by 19 mm (with aluminium case)

⇒ for nominal pressure  $P_N > 400\text{ bar}$  increases the length of devices by 39 mm

<sup>8</sup> aluminium case is horizontally rotatable as standard

**Standard pressure ports (dimensions in mm)**

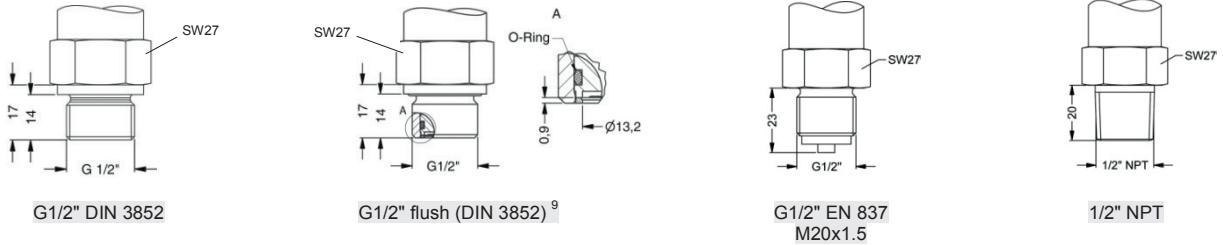

<sup>9</sup> not possible for vacuum and nominal pressure ranges > 40 bar

**Process connections up to 40 bar (dimensions in mm)**

**Inch thread (DIN 3852)**

G1" flush  
(PN ≤ 400 bar)

**DRD<sup>10</sup>**

(PN ≤ 25 bar)

**Flange (DIN 2501)**

dimensions in mm			
size	DN25/PN40	DN50/PN40	DN80/PN16
D	115	165	200
E	30	89	89
k	85	125	160
b	18	20	20
n	4	4	8
d	14	18	18
PN	≤ 40 bar	≤ 40 bar	≤ 16 bar

**Flange (ANSI B16.5)**

dimensions in mm		
size	2"/150 lbs	3"/150 lbs
D	152.4	190.5
E	86	89
g	91.9	127
k	120.7	152.4
b	19.1	23.9
n	4	4
d	19.1	19.1
PN	≤ 10 bar	≤ 10 bar

**Cooling element**

temperature range	300° C
-------------------	--------

<sup>10</sup> mounting flange is included in the delivery (already pre-assembled)

HART<sup>®</sup> is a registered trade mark of HART Communication Foundation; Hastelloy<sup>®</sup> is a brand name of Haynes International Inc. Windows<sup>®</sup> is a registered trade mark of Microsoft Corporation

**XMP i**

--	--	--	--	--	--	--	--	--	--	--	--	--	--	--	--	--	--	--	--	--

<b>Pressure</b>																					
	gauge	5	1	1																	
	absolute <sup>1</sup>	5	1	2																	
<b>Input</b>																					
	[bar] <sup>Δ</sup>																				
	0 ... 0.4 <sup>1</sup>	4	0	0	0																
	0 ... 1	1	0	0	1																
	0 ... 2	2	0	0	1																
	0 ... 4	4	0	0	1																
	0 ... 10	1	0	0	2																
	0 ... 20	2	0	0	2																
	0 ... 40	4	0	0	2																
	0 ... 100	1	0	0	3																
	0 ... 200	2	0	0	3																
	0 ... 400	4	0	0	3																
	0 ... 600	6	0	0	3																
	-0.4 ... 0.4	S	4	0	0																
	-1 ... 1	S	1	0	2																
	-1 ... 2	V	2	0	2																
	-1 ... 4	V	4	0	2																
	-1 ... 10	V	1	0	3																
	customer	9	9	9	9															consult	
<b>Design</b>																					
<b>Aluminium die cast case</b>																					
	with display														A	0					
	without display														A	N					
<b>Stainless steel field housing</b>																					
	with display														F	V					
	without display														F	N					
	customer														9	9				consult	
<b>Output</b>																					
	Intrinsic safety 4 ... 20 mA / 2-wire with HART <sup>®</sup> -communication														I						
	Intrinsic safety Ex d 4 ... 20 mA / 2-wire (flameproof enclosure) with HART <sup>®</sup> -communication <sup>2</sup>														G						
	customer														9					consult	
<b>Accuracy</b>																					
	0.1 %														1						
<b>Electrical connection</b>																					
	terminal clamp alu housing														A	K	0				
	terminal clamp field housing														8	8	0				
	customer														9	9	9			consult	
<b>Mechanical connection</b>																					
<b>Standard pressure connections</b>																					
	G1/2" DIN 3852														1	0	0				
	G1/2" DIN 3852 with <sup>3</sup> flush sensor														F	0	0				
	G1/2" EN 837														2	0	0				
	1/2" NPT														N	0	0				
<b>Process connections (up to 40 bar)</b>																					
	G1" with flush welded diaphragm (DIN 3852)														Z	3	1				
	Flange DN 25 / PN 40 (DIN 2501)														F	2	0				
	Flange DN 50 / PN 40 (DIN 2501)														F	2	3				
	Flange DN 80 / PN 16 (DIN 2501)														F	1	4				
	Flansch DN 2" / 150 lbs (ANSI B16.5) <sup>4</sup>														F	3	2				
	Flansch DN 3" / 150 lbs (ANSI B16.5) <sup>4</sup>														F	3	3				
	DRD Ø 65 mm <sup>5</sup>														D	R	D				
<b>Diaphragm</b>																					
	Stainless steel 1.4435 (316L)														1						
	Hastelloy <sup>®</sup> <sup>6</sup>														H						
	Tantal <sup>6,7</sup>														T					consult	
<b>Seals</b>																					
<b>Inch thread:</b>																					
	FKM														1						
	FFKM <sup>8</sup>														7						
<b>EN 837:</b>	without (welded version) <sup>9</sup>														2						
<b>DRD, flange:</b>	without														0						
<b>Filling Fluids</b>																					
	Silicon oil														1						
	food compatible oil <sup>6</sup>														2						
	Halocarbon <sup>6</sup>														C					consult	
	customer														9					consult	
<b>Special version</b>																					
	standard																		0	0	0
	with cooling element up to 300 °C <sup>6</sup>																		2	0	0
	special compensation -40 ... +60 °C <sup>10</sup>																		0	2	2

**Δ** if setting range shall be different from nominal range please specify in your order  
<sup>1</sup> absolute pressure possible from 1 bar  
<sup>2</sup> only possible in combination with aluminium die cast case  
<sup>3</sup> not possible for vacuum ranges and pressure ranges > 40 bar  
<sup>4</sup> 2"/150 lbs and 3"/150 lbs possible for nominal pressure ranges P<sub>N</sub> ≤ 10 bar  
<sup>5</sup> mounting flange is included in the delivery (already pre-assembled)  
<sup>6</sup> only possible with process connections  
<sup>7</sup> tantal diaphragm possible with nominal pressure ranges from 1 bar  
<sup>8</sup> min. permissible temperature from -15 °C, possible for nominal pressure ranges P<sub>N</sub> ≤ 100 bar  
<sup>9</sup> possible with pressure ranges between 1 bar and 40 bar  
<sup>10</sup> option for version without display





# XMP ci

## Process Pressure Transmitter with HART<sup>®</sup>-communication

Ceramic Sensor

accuracy according to IEC 60770:  
0.1 % FSO

### Nominal pressure

from 0 ... 60 mbar up to 0... 20 bar

### Output signals

2-wire: 4 ... 20 mA  
others on request

### Special characteristics

- ▶ turn-down 1:5
- ▶ two chamber aluminium die cast case or stainless field housing
- ▶ internal or flush mounted capacitive ceramic sensor
- ▶ HART<sup>®</sup>-communication
- ▶ IS-version:  
Ex ia = intrinsically safe version
- ▶ diaphragm Al<sub>2</sub>O<sub>3</sub> 99.9 %

### Optional versions

- ▶ IS-version: Ex d = flameproof enclosure
- ▶ with integrated display and operating module
- ▶ several process connections (thread, flange, DRD etc.)

The process pressure transmitter XMP ci measures the pressure of gases, steam and fluids. The special-developed capacitive ceramic sensor for this transmitter has a high overpressure capability and excellent media stability.

Several process connections e.g. thread or flange are available. The transmitter is as a standard equipped with HART<sup>®</sup>-communication, the customer can choose between a two chamber aluminium die cast case or a stainless field housing.

### Preferred areas of use are



Oil and gas industry



Chemical and petrochemical industry

### Preferred using in



Fuel and Oil



aggressive Media



Pressure ranges <sup>1</sup>										
Nominal pressure gauge	[bar]	0.06	0.16	0.4	1	2	5	10	20	
Overpressure	[bar]	2	4	6	8	15	25	35	45	
Permissible vacuum	[bar]	-0.2	-0.3	-0.5			-1			
<sup>1</sup> On customer request we adjust the devices by software to the required pressure ranges. Within the turn-down-possibility (starting at 0.02 bar).										
Output signal / Supply										
Standard	2-wire: 4 ... 20 mA intrinsically safe version with HART®-communication / V <sub>S</sub> = 12 ... 28 V <sub>DC</sub>									
Option	IS version flameproof enclosure / V <sub>S</sub> = 13 ... 28 V <sub>DC</sub>									
Current consumption	max. 25 mA									
Performance										
Accuracy <sup>2</sup>	nominal pressure < 1 bar: ≤ ± 0.2 % FSO									
	nominal pressure ≥ 1 bar: ≤ ± 0.1 % FSO									
	for nominal pressure ranges: from 0.06 bar up to 0.4 bar				≤ ± (0.2 + (TD-1) x 0.02) % FSO					
	for nominal pressure ranges: from 1 bar up to 20 bar				≤ ± (0.1 + (TD-1) x 0.01) % FSO					
with turn-down = nominal pressure range / adjusted range										
Permissible load	R <sub>max</sub> ≤ [(V <sub>S</sub> - V <sub>S min</sub> ) / 0.02 A] Ω					load during HART®-communication: R <sub>min</sub> = 250 Ω				
Influence effects	supply: 0.05 % FSO / 10 V					permissible load: 0.05 % FSO / kΩ				
Long term stability	≤ ± 0.1 % FSO / year									
Response time	200 msec – without consideration of electronic damping						measuring rate 5/sec			
Adjustability	electronic damping: 0 ... 100 sec offset 0 ... 80 % FSO turn-down of span: max. 1:5 (span min. 0.02 bar)									
<sup>2</sup> accuracy according to IEC 60770 – limit point adjustment (non-linearity, hysteresis, repeatability)										
Thermal errors / Permissible temperatures										
Thermal error	≤ ± (0.02 x turn-down) % FSO / 10 K in compensated range -20 ... 80 °C									
Permissible temperatures <sup>3</sup>	without display: medium: -25 ... 125 °C		environment: -40 ... 70 °C		storage: -40 ... 80 °C					
	with display: medium: -25 ... 125 °C		environment: -20 ... 70 °C		storage: -30 ... 80 °C					
<sup>3</sup> for pressure port of PVDF the minimum permissible temperature is -30 °C										
Electrical protection										
Short-circuit protection	permanent									
Reverse polarity protection	no damage, but also no function									
Electromagnetic compatibility	emission and immunity according to EN 61326									
Mechanical stability										
Vibration	5 g RMS (20 ... 2000 Hz)									
Shock	100 g / 11 msec									
Materials										
Pressure port	stainless steel 1.4404 (316L)									
Standard	PVDF									
Optionally for G1 1/2" flush	aluminium die cast, powder-coated or stainless steel 1.4404 (316L)									
Housing	aluminium die cast, powder-coated or stainless steel 1.4404 (316L)									
Cable gland	brass, nickel plated									
Viewing glass	laminated safety glass									
Seals (media wetted)	FKM (permissible temperature: -25 ... 125 °C) EPDM (permissible temperature: -40 ... 125 °C) others on request									
Diaphragm	ceramics Al <sub>2</sub> O <sub>3</sub> 99.9 %									
Media wetted parts	pressure port, seal, diaphragm									
Explosion protection										
Approval AX12-XMP ci (intrinsically safe version)	IBExU 05 ATEX 1106 X stainless steel field housing: zone 0/1 <sup>4</sup> : II 1/2G Ex ia IIC T4 Ga/Gb / II 1D Ex ia IIIC T85 °C Da aluminium die cast case: zone 1: II 2G Ex ia IIB T4 Gb / II 1D Ex ia IIIC T85 °C Da									
Safety techn. maximum values	U <sub>i</sub> = 28 V, I <sub>i</sub> = 93 mA, P <sub>i</sub> = 660 mW, C <sub>i</sub> = 0 nF, L <sub>i</sub> = 0 μH, C <sub>GND</sub> = 27 nF									
Approval AX17-XMP ci (flameproof enclosure)	IBExU 12 ATEX 1045 X aluminium die cast case: zone 1: II 2G Ex d IIC T5 Gb									
Permissible temperatures for environment	in zone 0: -20 ... 60 °C with p <sub>atm</sub> 0.8 bar up to 1.1 bar in zone 1: -25 ... 70 °C (intrinsically safe version); -20 ... 70 °C (flameproof enclosure)									
<sup>4</sup> The designation depends on the nominal pressure range. Nominal pressure ranges ≤ 60 mbar are marked with „2G“. For nominal pressure ranges > 60 mbar and < 10 bar see note under item 17 in the EC type-examination certificate!										

**Miscellaneous**

Display (optionally)	LC-display, visible range 32.5 x 22.5 mm; 5-digit 7-segment main display, digit height 8 mm, range of indication ±9999; 8-digit 14-segment additional display, digit height 5 mm; 52-segement bargraph; accuracy 0.1% ± 1 digit
Ingress protection	IP 67
Installation position	any
Weight	min. 400 g (depending on housing and mechanical connection)
Operational life	> 100 x 10 <sup>6</sup> pressure cycles
CE-conformity	EMC Directive: 2004/108/EC

**Wiring diagram**

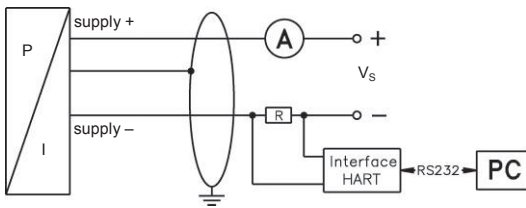

**Pin configuration**

Electrical connections	aluminium die cast case: terminal clamps (clamp section: 2.5 mm <sup>2</sup> )	stainless steel field housing: terminal clamps (clamp section: 1.5 mm <sup>2</sup> )
Supply +	IN+	IN+
Supply -	IN-	IN-
Test	Test	-
Shield	⏚	⏚

**Housing designs <sup>5</sup> (dimensions in mm)**

**aluminium die cast case with display**

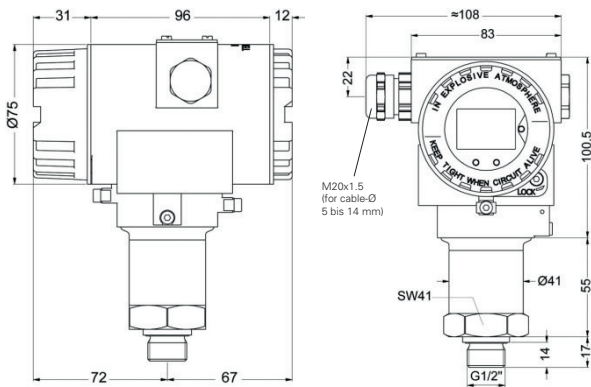

G1/2" DIN 3852

**stainless steel field housing with display**

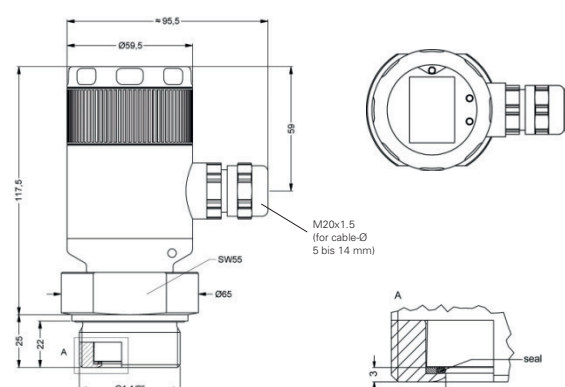

G1 1/2" flush DIN 3852

**aluminium die cast case without display**

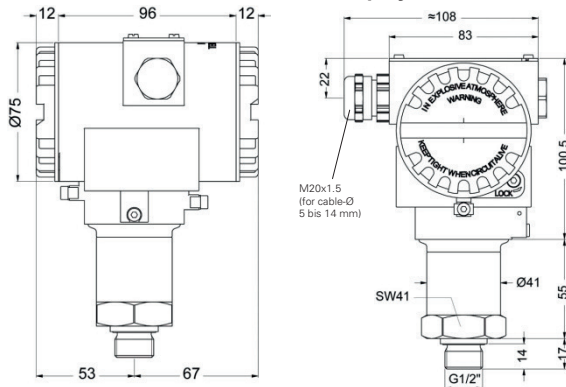

G1/2" DIN 3852

**stainless steel field housing without display**

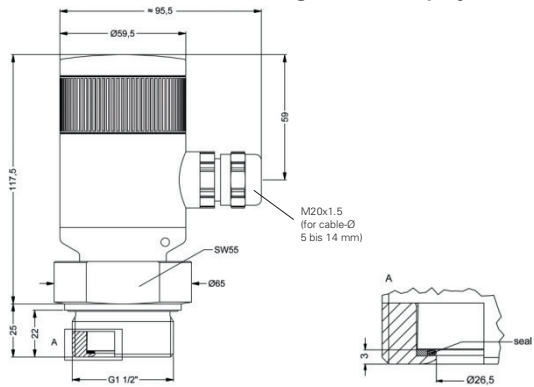

G1 1/2" flush DIN 3852

<sup>5</sup> aluminium die cast case is horizontally rotatable as standard

**Standard pressure ports (dimensions in mm)**

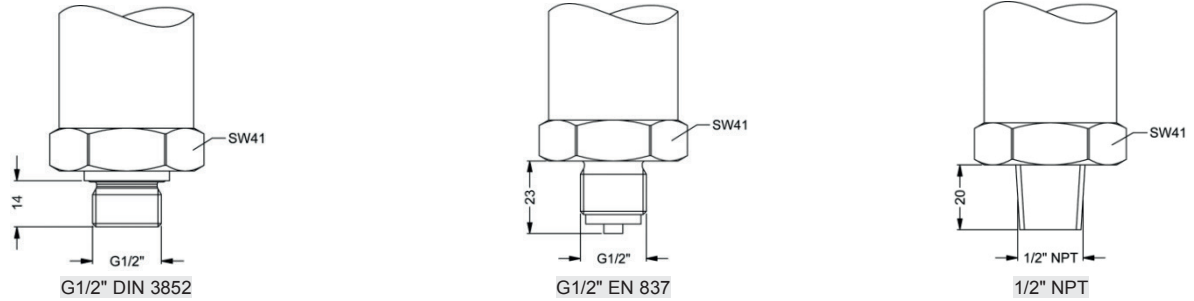

**Process connections (dimensions in mm)**

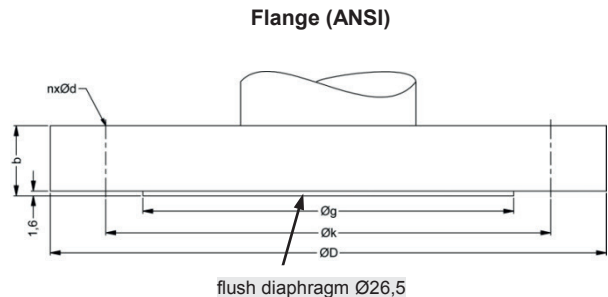
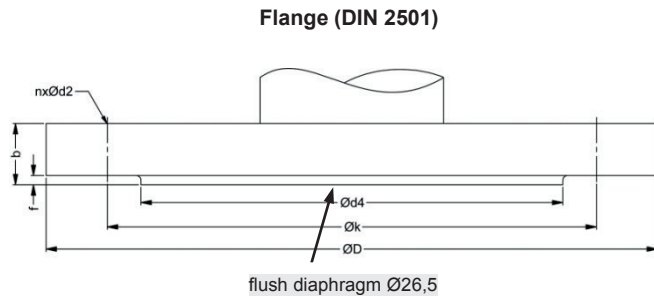
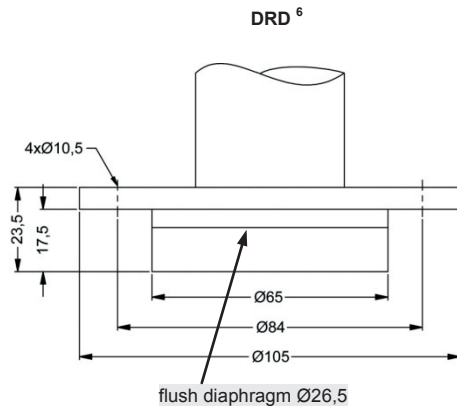
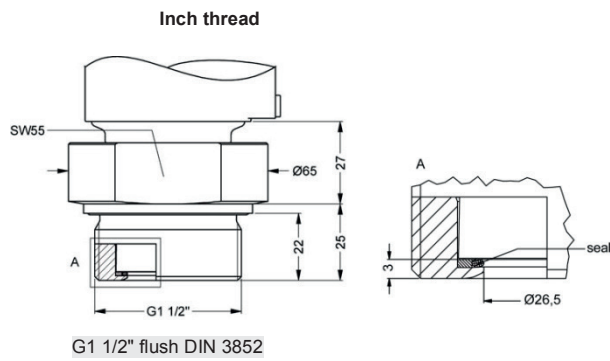

dimensions in mm			
size	DN25	DN50	DN80
D	115	165	200
k	85	125	160
d4	68	102	138
b	18	20	20
f	2	3	3
n	4	4	8
d2	14	18	18
P <sub>N</sub>	≤ 40 bar	≤ 40 bar	≤ 16 bar

dimensions in mm		
size	2"/150 lbs	3"/150 lbs
D	152.4	190.5
g	91.9	127
k	120.7	152.4
b	19.1	23.9
n	4	4
d	19.1	19.1
P <sub>N</sub>	≤ 10 bar	≤ 10 bar

<sup>6</sup> mounting flange is included in the delivery (already pre-assembled)  
 HART<sup>®</sup> is a registered trade mark of HART Communication Foundation;  
 Windows<sup>®</sup> is a registered trade mark of Microsoft Corporation

# XMP ci

Ordering Code

XMP ci



<b>Pressure</b>												
	gauge	5	1	E								
<b>Input</b>												
	[bar]	▲										
	0.06	0	6	0	0							
	0.16	1	6	0	0							
	0.4	4	0	0	0							
	1	1	0	0	1							
	2	2	0	0	1							
	5	5	0	0	1							
	10	1	0	0	2							
	20	2	0	0	2							
	customer	9	9	9	9						consult	
<b>Design</b>												
<b>Aluminium die cast case</b>												
	with display					A	0					
	without display					A	N					
<b>Stainless steel field housing</b>												
	with display					F	V					
	without display					F	N					
	customer					9	9				consult	
<b>Output</b>												
	Intrinsic safety 4 ... 20 mA / 2-wire with HART®-communication					I						
	Intrinsic safety d 4 ... 20 mA / 2-wire (flameproof enclosure) with HART®-communication <sup>1</sup>					G						
	customer					9					consult	
<b>Accuracy</b>												
	0.1 %					1						
	customer					9					consult	
<b>Electrical connection</b>												
	terminal clamp alu housing					A	K	0				
	terminal clamp field housing					8	8	0				
	customer					9	9	9			consult	
<b>Mechanical connection</b>												
<i>standard pressure connections:</i>												
	G1/2" DIN 3852					1	0	0				
	G1/2" EN 837					2	0	0				
	1/2" NPT					N	0	0				
<i>process connections:</i>												
	G 1 1/2" DIN flush (DIN 3852)					M	0	0				
	Flange DN 25 / PN 40 (DIN 2501)					F	2	0				
	Flange DN 50 / PN 40 (DIN 2501)					F	2	3				
	Flange DN 80 / PN 16 (DIN 2501)					F	1	4				
	Flansch DN 2" / 150 lbs (ANSI B16.5) <sup>2</sup>					F	3	2				
	Flansch DN 3" / 150 lbs (ANSI B16.5) <sup>2</sup>					F	3	3				
	DRD Ø 65 mm <sup>3</sup>					D	R	D				
	customer					9	9	9			consult	
<b>Diaphragm</b>												
	Ceramics Al <sub>2</sub> O <sub>3</sub> 99,9%					C						
	customer					9					consult	
<b>Seals</b>												
	FKM <sup>4</sup>					1						
	EPDM <sup>4</sup>					3						
	customer					9					consult	
<b>Pressure port</b>												
<i>standard:</i>												
	Stainless steel 1.4404 (316L)					1						
<i>option for G 1 1/2" flush:</i>												
	PVDF <sup>4</sup>					B						
	customer					9					consult	
<b>Special version</b>												
	standard									0	0	0
	customer									9	9	9
												consult

▲ if setting range shall be different from nominal range please specify in your order

<sup>1</sup> only possible in combination with aluminium die cast case  
<sup>2</sup> 2"/150 lbs and 3"/150 lbs only possible for nominal pressure ranges PN ≤ 10 bar  
<sup>3</sup> mounting flange is included in the delivery (already pre-assembled)  
<sup>4</sup> permissible temperature FKM -25 ... 125 °C, EPDM -40 ... 125 °C, PVDM -30 ... 125 °C

HART® is a registered trade mark of HART Communication Foundation; Varivent® is a brand name of GEA Tuchenhausen GmbH

This document contains product specifications; properties are not guaranteed. Detailed information about options are defined in the datasheet. Subject to change without notice.





# x|act i

## Precision Pressure Transmitter For Food / Beverage And Pharmaceutical Industry And Biotechnology

Stainless Steel Sensor

accuracy according to IEC 60770:  
0.1 % FSO

### Nominal pressure

from 0 ... 400 mbar up to 0 ... 40 bar

### Output signals

2-wire: 4 ... 20 mA  
others on request

### Special characteristics

- ▶ turn-down 1:10
- ▶ hygienic version
- ▶ flush welded diaphragm
- ▶ several process connections (G1" cone, Clamp, dairy pipe, etc.)
- ▶ integrated display and operating module

### Optional versions

- ▶ IS-version  
Ex ia = intrinsically safe for gases and dust
- ▶ HART®-communication
- ▶ cooling element for media temperatures up to 300 °C

The precise pressure transmitter x|act i has been especially designed for the food / beverage, pharmaceutical industry and biotechnology and measures vacuum, gauge and absolute pressure of gases, steam and fluids up to 40 bar.

Several process connections e.g. thread or hygienic versions like Varivent®, dairy pipe and Clamp with a flush welded diaphragm are available, which can be combined with a cooling element for media temperatures up to 300 °C. The robust stainless steel globe housing has a high ingress protection IP 67 and all characteristics for a residue-free and antibacterial cleaning.

### Preferred areas of use are



Food and Beverage



Pharmaceutical Industry

### Material and test certificates

- ▶ inspection certificate 3.1 according to EN 10204
- ▶ test report 2.2 according to EN 10204



Pressure ranges <sup>1</sup>								
Nominal pressure gauge / abs.	[bar]	0.4	1	2	4	10	20	40
Overpressure	[bar]	2	5	10	20	40	80	105
Burst pressure	[bar]	3	7,5	15	25	50	120	210

<sup>1</sup> higher pressure ranges on request; on demand we adjust the devices within the turn-down-possibility by software on the required pressure ranges  
<sup>2</sup> absolute pressure possible from 1 bar

Vacuum ranges						
Nominal pressure gauge	[bar]	-0.4 ... 0.4	-1 ... 1	-1 ... 2	-1 ... 4	-1 ... 10
Overpressure	[bar]	2	5	10	20	40
Burst pressure	[bar]	3	7,5	15	25	50

Output signal / Supply	
Standard	2-wire: 4 ... 20 mA / V <sub>S</sub> = 12 ... 30 V <sub>DC</sub>
Option	IS-protection: 2-wire: 4 ... 20 mA / V <sub>S</sub> = 12 ... 28 V <sub>DC</sub> IS-protection / HART <sup>®</sup> : 2-wire: 4 ... 20 mA with HART <sup>®</sup> communication / V <sub>S</sub> = 12 ... 28 V <sub>DC</sub>
Current consumption	max. 25 mA

Performance		
Accuracy <sup>3</sup>	≤ ± 0.1 % FSO	The accuracy is calculated as follows ≤ 0.1 + 0.015 x (turn-down - 5) % FSO e.g. turn-down 9: ≤ 0.1 + 0.015 x (9 - 5) % FSO = 0.16 % FSO
Performance after turn-down	- turn-down ≤ 1:5: no change - turn-down > 1:5:	
Permissible load	R <sub>max</sub> = [(V <sub>S</sub> - V <sub>Smin</sub> ) / 0.02 A] Ω	load during HART <sup>®</sup> communication: R <sub>min</sub> = 250 Ω
Influence effects	supply: 0.05 % FSO / 10 V	permissible load: 0.05 % FSO / kΩ
Long term stability	≤ ± (0.1 x turn-down) % FSO / year at reference conditions	
Response time	100 msec – without consideration of electronic damping	measuring rate 10/sec
Adjustability	electronic damping: 0 ... 100 sec offset: 0 ... 90 % FSO	turn-down of span: max. 1:10

<sup>3</sup> accuracy according to IEC 60770 – limit point adjustment (non-linearity, hysteresis, repeatability)

Thermal effects (Offset and Span) / Permissible temperatures	
Tolerance band <sup>4,5</sup>	≤ ± 0.2 % FSO x Turn-Down
in compensated range	-20 ... 85 °C
Permissible temperatures <sup>6</sup>	medium: -40 ... 125 °C for filling fluid silicon oil -10 ... 125 °C for filling fluid food compatible oil environment: -20 ... 70 °C storage: -30 ... 80 °C
Permissible temperature medium for cooling element 300°C	filling fluid silicon oil overpressure: -40 ... 300 °C vacuum pressure: -40 ... 150 °C filling fluid food compatible oil overpressure: -10 ... 250 °C vacuum pressure: -10 ... 150 °C

<sup>4</sup> an optional cooling element can influence thermal effects for offset and span depending on installation position and filling conditions

<sup>5</sup> for flange-, Varivent-, DRD-version: tolerance band offset ≤ ± 1.6 % FSO / tolerance band span ≤ ± 0.6 % FSO

<sup>6</sup> for vacuum ranges and absolute pressure the max. medium temperature is 70 °C;

max. temperature of the medium for nominal pressure gauge > 0 bar: 150 °C for 60 minutes with a max. environmental temperature of 50 °C (without cooling element).

Electrical protection	
Short-circuit protection	permanent
Reverse polarity protection	no damage, but also no function
Electromagnetic compatibility	emission and immunity according to EN 61326

Mechanical stability	
Vibration	5 g RMS (25 ... 2000 Hz) according to DIN EN 60068-2-6
Shock	100 g / 11 msec according to DIN EN 60068-2-27

Filling fluids	
Standard	silicon oil
Options	food compatible oil (with FDA approval) (Mobil DTE FM 32; Category Code: H1; NSF Registration No.: 130662) Halocarbon and others on request

Materials		
Pressure port	G1" cone, Varivent <sup>®</sup> , dairy pipe und Clamp: DRD and flange:	stainless steel 1.4435 (316 L) stainless steel 1.4404 (316L)
Housing	stainless steel 1.4301 (304)	
Viewing glass	laminated safety glass	
Seals (media wetted)	none, not included in the scope of delivery	
Diaphragm		
Standard	stainless steel 1.4435 (316 L)	
Options	Hastelloy <sup>®</sup> C-276 (2.4819)	Tantalum (possible from 1 bar on) on request
Media wetted parts	pressure port, diaphragm, seal (if existing)	

Explosion protection	
Approval AX12-x act i	IBExU 05 ATEX 1106 X zone 0: II 1G Ex ia IIC T4 Ga / II 1D Ex ia IIIC T85 °C Da
Safety technical maximum values	$U_i = 28 \text{ V}$ , $I_i = 93 \text{ mA}$ , $P_i = 660 \text{ mW}$ , $C_i = 0 \text{ nF}$ , $L_i = 0 \text{ }\mu\text{H}$ , the supply connections have an inner capacity of max. 27 nF to the housing
Permissible temperatures for environment	in zone 0: -20 ... 60 °C with $p_{\text{atm}}$ 0.8 bar up to 1.1 bar in zone 1: -25 ... 70 °C
Connecting cables (by factory)	capacitance: signal line/shield also signal line/signal line: 160 pF/m inductance: signal line/shield also signal line/signal line: 1 $\mu\text{H}/\text{m}$
Miscellaneous	
Display	LC display, visible range 32.5 x 22.5 mm; 5-digit 7-segment main display, digit height 8 mm, range of indication $\pm 9999$ ; 8-digit 14-segment additional display, digit height 5 mm; 52-segement bargraph; accuracy 0.1% $\pm$ 1 digit
Ingress protection	IP 67
Installation position	any (standard calibration in a vertical position with the pressure port connection down; differing installation position for $P_N \leq 2 \text{ bar}$ have to be specified in the order)
Weight	min. 400 g (depending on mechanical connection)
Operational life	> 100 x 10 <sup>6</sup> pressure cycles
CE-conformity	EMC Directive: 2004/108/EC

**Wiring diagrams**

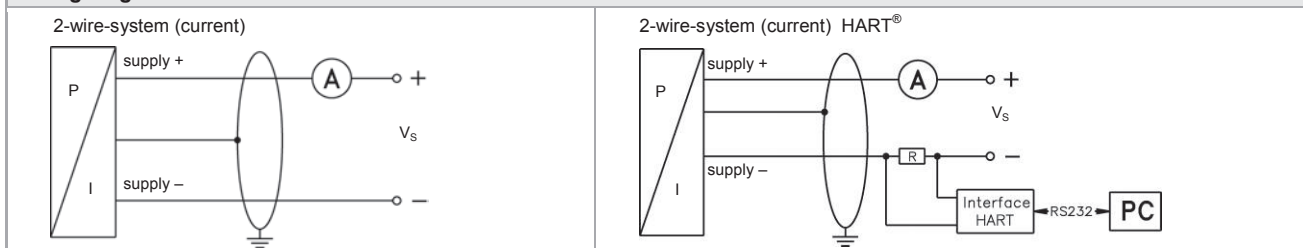

**Pin configuration**

Electrical connections	M12x1 (4-pin)
Supply +	1
Supply -	3
Shield	plug housing

**Electrical connections (dimensions in mm)**

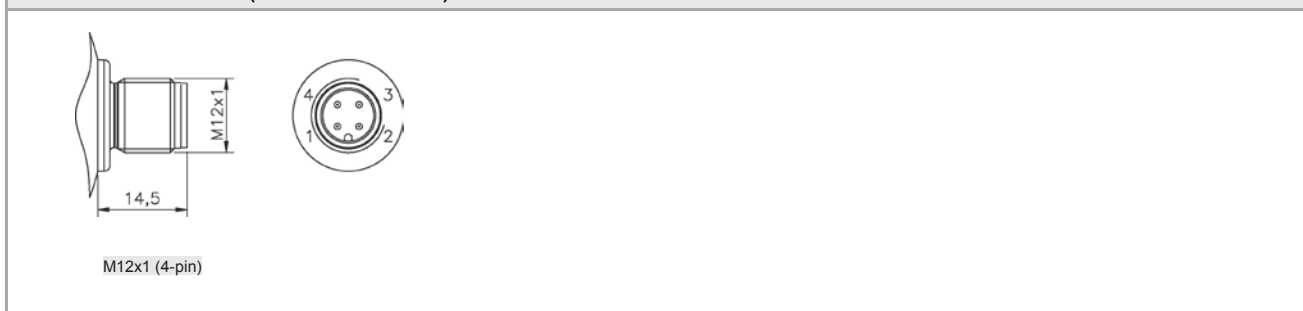

**Designs <sup>7</sup>**

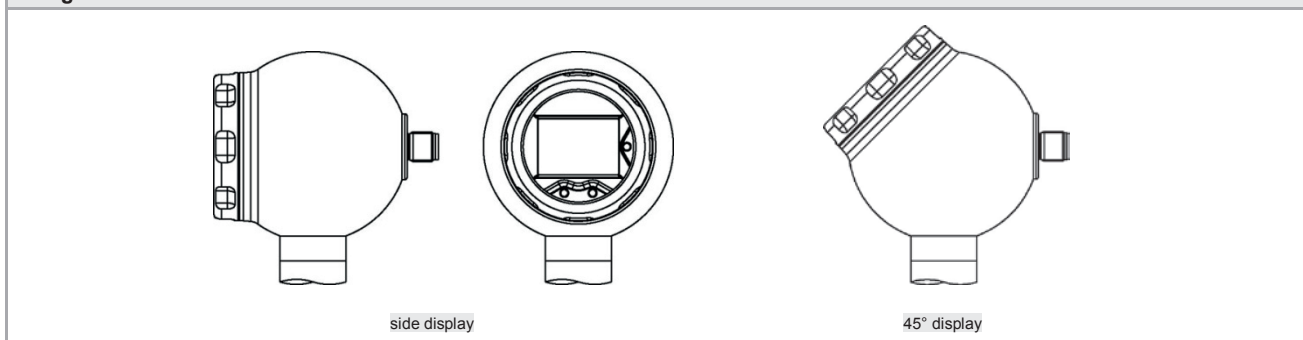

<sup>7</sup> all designs in combination with G1" cone in horizontal rotatable housing as standard; other mech. connections in rotatable housing on request

Dimensions (in mm)

G1" cone

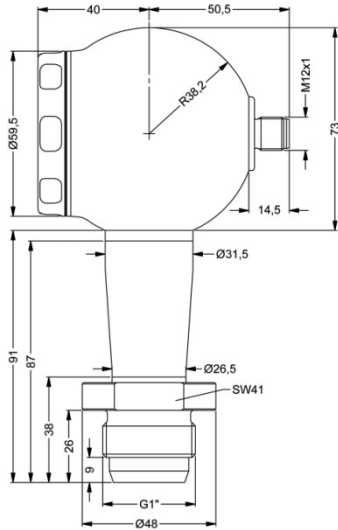

Clamp (DIN 32676)

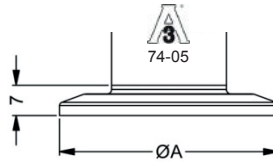

dimensions in mm				
size	3/4"	DN25	DN32	DN50
A	25	50.5	50.5	64
P <sub>N</sub> [bar]	≤ 8	≤ 16	≤ 16	≤ 16

Dairy pipe <sup>7</sup> (DIN 11851)

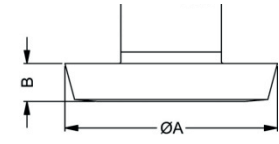

dimensions in mm			
size	DN 25	DN 40	DN 50
A	44	56	68.5
B	10	10	11
P <sub>N</sub> [bar]	≤ 40	≤ 40	≤ 40

Varivent<sup>®</sup>

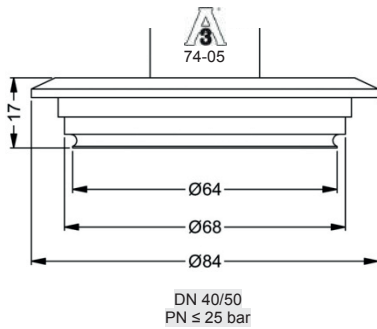

Flange (DIN 2501)

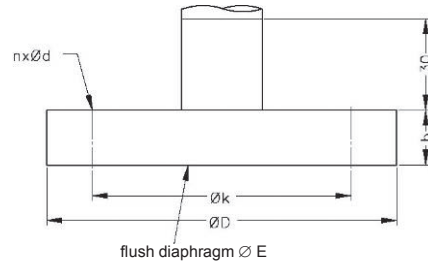

dimensions in mm			
size	DN25	DN50	DN80
D	115	165	200
E	30	89	89
k	85	125	160
b	18	20	20
n	4	4	8
d	14	18	18
PN [bar]	≤ 40	≤ 40	≤ 16

DRD <sup>8</sup>

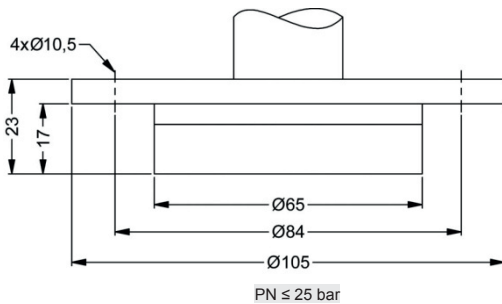

Cooling element

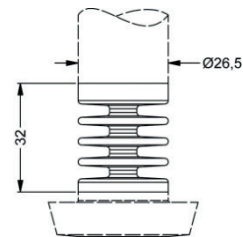

temperature range 300 °C

<sup>8</sup> cup nut resp. mounting flange is included in the delivery (already pre-assembled)  
HART<sup>®</sup> is a registered trade mark of HART Communication Foundation; Hastelloy<sup>®</sup> is a trademark of Haynes International Inc.;  
Varivent<sup>®</sup> is a trademark of GEA Tuchenhagen GmbH; Windows<sup>®</sup> is a registered trade mark of Microsoft Corporation

x act i		[ ]	[ ]	[ ]	[ ]	[ ]	[ ]	[ ]	[ ]	[ ]	[ ]	[ ]	[ ]	[ ]	[ ]	[ ]	[ ]	[ ]	[ ]	[ ]	
<b>Pressure</b>		gauge	5	1	1																
	absolute <sup>1</sup>		5	1	2																
<b>Input</b>		[bar]																			
	0 ... 0.4 <sup>1</sup>		4	0	0	0															
	0 ... 1		1	0	0	1															
	0 ... 2		2	0	0	1															
	0 ... 4		4	0	0	1															
	0 ... 10		1	0	0	2															
	0 ... 20		2	0	0	2															
	0 ... 40		4	0	0	2															
	-0.4 ... 0.4		S	4	0	0															
	-1 ... 1		S	1	0	2															
	-1 ... 2		V	2	0	2															
	-1 ... 4		V	4	0	2															
	-1 ... 10		V	1	0	3															
	customer		9	9	9	9														consult	
<b>Design</b>		side display					K	H													
	45° display						K	4													
<b>Output</b>		4 ... 20 mA / 2-wire																			1
	Intrinsic safety 4 ... 20 mA / 2-wire																				E
	Intrinsic safety 4 ... 20 mA / 2-wire																				I
	with HART®-communication																				
	customer																				9
																					consult
<b>Accuracy</b>		0.1 %																			1
<b>Electrical connection</b>		Male plug M12x1 (4-pin)					M	1	0												
	customer						9	9	9												consult
<b>Mechanical connection</b>		G1" cone										K	3	1							
	Clamp DN 25 / 1" (DIN 32676) / 3A											C	6	1							
	Clamp DN 32 / 1 1/2" (DIN 32676) / 3A											C	6	2							
	Clamp DN 50 / 2" (DIN 32676) / 3A											C	6	3							
	Clamp 3/4" (DIN 32676) / 3A											C	6	9							
	Dairy pipe DN 25 (DIN 11851) <sup>2</sup>											M	7	3							
	Dairy pipe DN 40 (DIN 11851) <sup>2</sup>											M	7	5							
	Dairy pipe DN 50 (DIN 11851) <sup>2</sup>											M	7	6							
	Varivent® DN 40/50 / 3A											P	4	1							
	Flange DN 25 / PN 40 (DIN 2501)											F	2	0							
	Flange DN 50 / PN 40 (DIN 2501)											F	2	3							
	Flange DN 80 / PN 16 (DIN 2501)											F	1	4							
	DRD Ø 65 mm <sup>2</sup>											D	R	D							
<b>Diaphragm</b>		Stainless steel 1.4435 (316L)																			1
	Hastelloy® C-276 (2.4819)																				H
	Tantalum <sup>3</sup>																				T
																					consult
<b>Seals</b>		without																			0
<b>Filling Fluids</b>		silicon oil																			1
	food grade oil (FDA) / 3A																				2
	Halocarbon																				C
	customer																				9
																					consult
																					consult
<b>Special version</b>		standard																			0
	with cooling element up to 300°C / 3A																				2
																					0

▲ if setting range shall be different from nominal range please specify in your order

<sup>1</sup> absolute pressure possible from 1 bar

<sup>2</sup> cup nut resp. mounting flange is included in the delivery (already pre-assembled)

<sup>3</sup> tantal diaphragm possible with nominal pressure ranges from 1 bar

HART® is a registered trade mark of HART Communication Foundation; Hastelloy® is a brand name of Haynes International Inc.

Varivent® is a brand name of GEA Tuchenhausen GmbH





## x|act ci

### Precision Pressure Transmitter for Food Industry, Pharmacy + Biotechnology

Ceramic Sensor

accuracy according to IEC 60770:  
0.1 % FSO

#### Nominal pressure

from 0 ... 60 mbar up to 0... 20 bar

#### Output signals

2-wire: 4 ... 20 mA  
others on request

#### Special characteristics

- ▶ Turn-Down 1:5
- ▶ hygienic version
- ▶ flush mounted, capacitive ceramic sensor
- ▶ several process connections (inch thread, Clamp, etc.)
- ▶ with integrated display and operating module
- ▶ diaphragm Al<sub>2</sub>O<sub>3</sub> 99.9 %



#### Optional versions

- ▶ IS-version:  
Ex ia = intrinsically safe version
- ▶ HART®-communication

The precise pressure transmitter x|act ci measures the pressure of gases, steam and fluids. The special-developed capacitive ceramic sensor for this transmitter, which can optionally be delivered in pure ceramic, has a high overpressure capability and excellent media stability.

Several process connections e.g. inch thread or hygienic versions like Varivent®, dairy pipe or Clamp are available. The robust stainless steel globe housing has a high ingress protection IP 67 and all characteristics for a residue-free and antibacterial cleaning.

#### Preferred areas of use are

-  Food Industry
-  Chemical and Petrochemical Industry
-  Laboratory Techniques

#### Preferred using in

-  Viscous and pasty media



<b>Pressure ranges<sup>1</sup></b>										
Nominal pressure gauge	[bar]	0.06	0.16	0.4	1	2	5	10	20	
Overpressure	[bar]	2	4	6	8	15	25	35	45	
Permissible vacuum	[bar]	-0.2	-0.3	-0.5			-1			
<sup>1</sup> On customer request we adjust the devices by software on the required pressure ranges (within the turn-down-possibility; starting at 0.02 bar).										
<b>Output signal / Supply</b>										
Standard	2-wire: 4 ... 20 mA / V <sub>S</sub> = 12 ... 30 V <sub>DC</sub>									
Option	2-wire: 4 ... 20 mA / V <sub>S</sub> = 12 ... 28 V <sub>DC</sub>									
IS-protection	2-wire: 4 ... 20 mA with HART <sup>®</sup> communication / V <sub>S</sub> = 12 ... 28 V <sub>DC</sub>									
IS-protection/ HART <sup>®</sup>										
Current consumption	max. 25 mA									
<b>Performance</b>										
Accuracy <sup>2</sup>	nominal pressure < 1 bar: ≤ ± 0,2 % FSO									
	nominal pressure ≥ 1 bar: ≤ ± 0,1 % FSO									
	for nominal pressure ranges: from 0.06 bar up to 0.4 bar		≤ ± (0.2 + (TD-1) x 0.02) % FSO							
	for nominal pressure ranges: from 1 bar up to 20 bar		≤ ± (0.1 + (TD-1) x 0.01) % FSO							
with turn-down = nominal pressure range / adjusted range										
Permissible load	R <sub>max</sub> ≤ [(V <sub>S</sub> - V <sub>S min</sub> ) / 0.02 A] Ω				load during HART <sup>®</sup> communication: R <sub>min</sub> = 250 Ω					
Influence effects	supply: 0.05 % FSO / 10 V				permissible load: 0.05 % FSO / kΩ					
Long term stability	≤ ± 0.1 % FSO / year									
Response time	200 msec – without consideration of electronic damping						measuring rate 5/sec			
Adjustability	electronic damping: 0 ... 100 sec offset: 0 ... 80 % FSO turn-down of span: max. 1:5 (span min. 0.02 bar)									
<sup>2</sup> accuracy according to IEC 60770 – limit point adjustment (non-linearity, hysteresis, repeatability)										
<b>Thermal errors / Permissible temperatures</b>										
Thermal error	≤ ± (0.02 x turn-down) % FSO / 10 K in compensated range -20 ... 80 °C									
Permissible temperatures	medium: -25 ... 125 °C			environment: -20 ... 70 °C			storage: -30 ... 80 °C			
<b>Electrical protection</b>										
Short-circuit protection	permanent									
Reverse polarity protection	no damage, but also no function									
Electromagnetic compatibility	emission and immunity according to EN 61326									
<b>Mechanical stability</b>										
Vibration	5 g RMS (20 ... 2000 Hz)									
Shock	100 g / 11 msec									
<b>Materials</b>										
Pressure port	inch thread, DRD and flange version, Varivent <sup>®</sup> , dairy pipe and clamp: stainless steel 1.4404 (316L)									
	optionally for G1 1/2" flush (DIN 3852): PVDF									
Housing	stainless steel 1.4301 (304)									
Viewing glass	laminated safety glass									
Seals	FKM (permissible temperature: -25 ... 125 °C) EPDM others on request									
Diaphragm	ceramics Al <sub>2</sub> O <sub>3</sub> 99.9 %									
Media wetted parts	pressure port, seals, diaphragm									
<b>Explosion protection</b>										
Approval AX12-x act ci	IBExU05ATEX1106 X zone 0/1 <sup>3</sup> : II 1/2G Ex ia IIC T4 Ga/Gb / II 1D Ex ia IIIC T85 °C Da									
Safety technical maximum values	U <sub>i</sub> = 28 V, I <sub>i</sub> = 93 mA, P <sub>i</sub> = 660 mW, C <sub>i</sub> = 0 nF, L <sub>i</sub> = 0 μH, the supply connections have an inner capacity of max. 27 nF to the housing									
Permissible temperatures for environment	in zone 0: -20 ... 60 °C with p <sub>atm</sub> 0.8 bar up to 1.1 bar ab zone 1: -25 ... 70 °C									
Connecting cables (by factory)	capacitance: signal line/shield also signal line/signal line: 160 pF/m inductance: signal line/shield also signal line/signal line: 1 μH/m									
<sup>3</sup> The designation depends on the nominal pressure range. Nominal pressure ranges ≤ 60 mbar are marked with „2G“. For nominal pressure ranges > 60 mbar and < 10 bar see note under item 17 in the EC type-examination certificate!										

Miscellaneous	
Display	LC-display, visible range 32.5 x 22.5 mm; 5-digit 7-segment main display, digit height 8 mm, range of indication $\pm 9999$ ; 8-digit 14-segment additional display, digit height 5 mm; 52-segement bargraph; accuracy $0.1\% \pm 1$ digit
Ingress protection	IP 67
Installation position	any
Weight	min. 400 g (depending on mechanical connection)
Operational life	$> 100 \times 10^6$ pressure cycles
CE-conformity	EMC Directive: 2004/108/EC

#### Wiring diagram

2-wire-system (current)

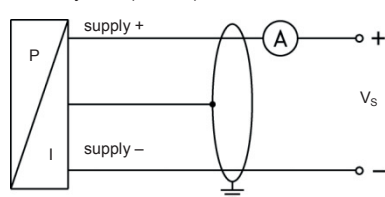

2-wire-system (current) HART®

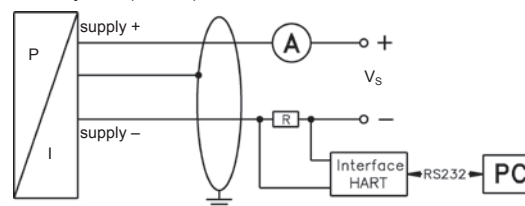

#### Pin configuration

Electrical connections	M12x1 (4-pin)	cable colours (DIN 47100)
Supply +	1	wh (white)
Supply -	3	bn (brown)
Shield	plug housing	ye/gn (yellow / green)

#### Electrical connections (in mm)

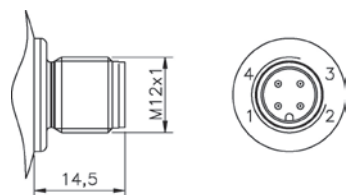

M12x1 (4-pin)

#### Designs <sup>4</sup>

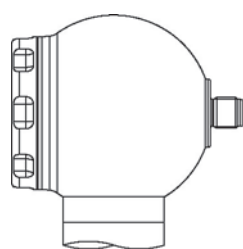

side display

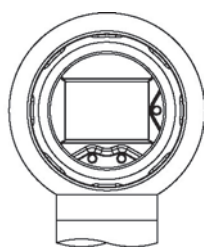

45° display

<sup>4</sup> all designs in combination with G1 1/2" flush in horizontal rotatable housing as standard;  
other mech. connections in rotatable housing on request

**Dimensions (in mm)**

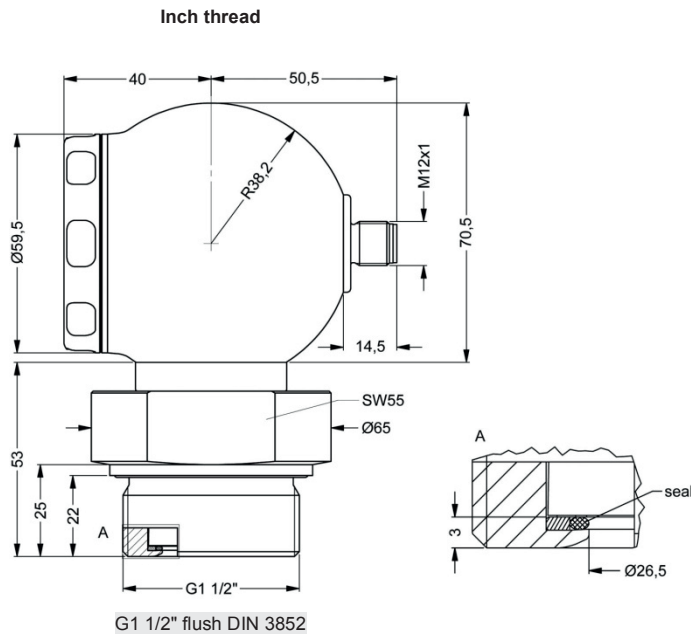

**Clamp (DIN 32676)**

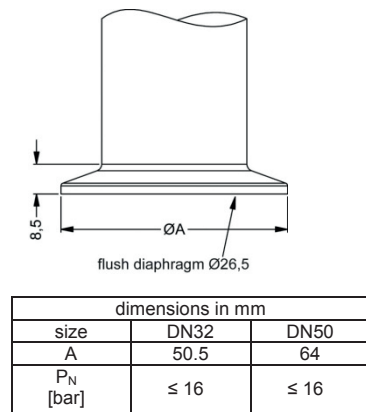

**Dairy pipe<sup>6</sup> (DIN 11851)**

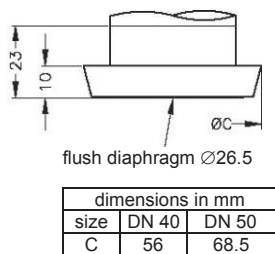

**Varivent<sup>®</sup>**

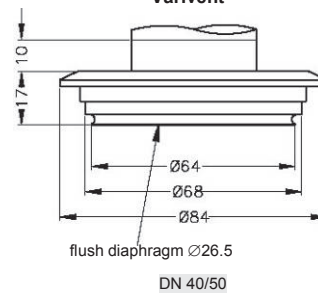

**Flange (DIN 2501)**

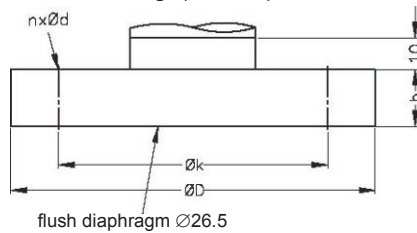

dimensions in mm			
size	DN25	DN50/PN40	DN80
D	115	165	200
k	85	125	160
b	18	20	20
n	4	4	8
d	14	18	18
P <sub>N</sub>	≤ 40 bar	≤ 40 bar	≤ 16 bar

**DRD<sup>5</sup>**

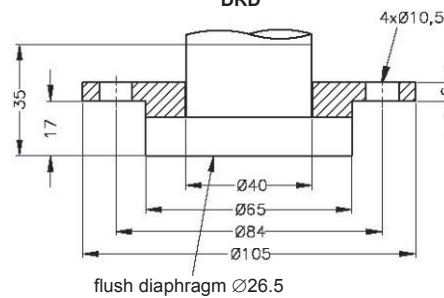

<sup>5</sup> cup nut for dairy pipe or mounting flange for DRD is included in the delivery (already pre-assembled)  
 HART<sup>®</sup> is a registered trade mark of HART Communication Foundation;  
 Varivent<sup>®</sup> is a trademark of GEA Tuchenhausen GmbH; Windows<sup>®</sup> is a registered trade mark of Microsoft Corporation

x|act ci



<b>Pressure</b>									
	gauge	5	1	E					
<b>Input</b>									
	[bar]	▲							
	0.06	0	6	0	0				
	0.16	1	6	0	0				
	0.4	4	0	0	0				
	1	1	0	0	1				
	2	2	0	0	1				
	5	5	0	0	1				
	10	1	0	0	2				
	20	2	0	0	2				
	customer	9	9	9	9				consult
<b>Design</b>									
	side display				K	H			
	45° display				K	4			
<b>Output</b>									
	4 ... 20 mA / 2-wire								1
	Intrinsic safety 4 ... 20 mA / 2-wire								E
	Intrinsic safety 4 ... 20 mA / 2-wire with HART®-communication								I
	customer								9
<b>Accuracy</b>									
	0.1 %								1
	customer								9
<b>Electrical connection</b>									
	Male plug M12x1 (4-pin)				M	1	0		
	customer				9	9	9		consult
<b>Mechanical connection</b>									
	G 1 1/2" DIN flush (DIN 3852)				M	0	0		
	Clamp DN 32 / 1 1/2" (DIN 32676)				C	6	2		
	Clamp DN 50 / 2" (DIN 32676)				C	6	3		
	Dairy pipe DN 40 (DIN 11851) <sup>1</sup>				M	7	5		
	Dairy pipe DN 50 (DIN 11851) <sup>1</sup>				M	7	6		
	Varivent® DN 40/50				P	4	1		
	Flange DN 25 / PN 40 (DIN 2501)				F	2	0		
	Flange DN 50 / PN 40 (DIN 2501)				F	2	3		
	Flange DN 80 / PN 16 (DIN 2501)				F	1	4		
	DRD Ø 65 mm <sup>1</sup>				D	R	D		
	customer				9	9	9		consult
<b>Diaphragm</b>									
	Ceramics Al <sub>2</sub> O <sub>3</sub> 99,9%								C
	customer								9
<b>Seals</b>									
	FKM								1
	EPDM								3
	customer								9
<b>Pressure port</b>									
	standard: Stainless steel 1.4404 (316L)								1
	option for G 1 1/2" flush: PVDF								B
	customer								9
<b>Special version</b>									
	standard								0
	customer								9
									9
									9
									consult

▲ if setting range shall be different from nominal range please specify in your order

<sup>1</sup> cup nut resp. mounting flange is included in the delivery (already pre-assembled)

HART® is a registered trade mark of HART Communication Foundation; Varivent® is a brand name of GEA Tuchenhagen GmbH





# DMP 331Pi

## Precision Pressure Transmitter

pressure ports and process connections with flush welded stainless steel diaphragm

accuracy according to IEC 60770:  
0,1 % FSO

### Nominal pressure

from 0 ... 400 mbar up to 0 ... 40 bar

### Output signals

2-wire: 4 ... 20 mA

3-wire: 0 ... 10 V

others on request

### Product characteristics

- ▶ excellent temperature response  
0.04 % FSO / 10K
- ▶ processing of the sensor signal using digital electronics
- ▶ process connections suitable for hygienic application
- ▶ vacuum resistant

### Optional versions

- ▶ IS-version  
Ex ia = intrinsically safe for gases and dusts
- ▶ communication interface for adjustment of offset, span and damping

The precision pressure transmitter DMP 331Pi demonstrates the further development of well-tried industrial pressure transmitter DMP 331P.

The signal from the specially designed piezoresistive stainless steel sensor is processed by the newly developed digital electronic system, performing thus an active compensation of sensor-specific deviations such as hysteresis, thermal errors and non-linearity.

The temperature range of -40 ... 125 °C can be extended by the integration of a cooling element up to 300 °C.

### Preferred areas of use are



Laboratory techniques



Food and beverage



Pharmaceutical industry



Pressure ranges <sup>1</sup>								
Nominal pressure gauge / absolute <sup>2</sup>	[bar]	0.4	1	2	4	10	20	40
Overpressure	[bar]	2	5	10	20	40	80	105
Burst pressure $\geq$	[bar]	3	7,5	15	25	50	120	210
Vacuum resistance		$P_N \geq 1$ bar: unlimited vacuum resistance $P_N < 1$ bar: on request						
<sup>1</sup> On customer request we adjust the device within the turn-down-possibility by software on the required pressure range.								
<sup>2</sup> absolut pressure permissible from 1 bar								
Vacuum ranges								
Nominal pressure	[bar]	-0.4 ... 0.4	-1 ... 1	-1 ... 2	-1 ... 4	-1 ... 10		
Overpressure	[bar]	2	5	10	20	40		
Burst pressure $\geq$	[bar]	3	7.5	15	25	50		
Output signal / Supply								
Standard		2-wire: 4 ... 20 mA / $V_S = 12 \dots 36 V_{DC}$						
Option IS-protection		2-wire: 4 ... 20 mA / $V_S = 14 \dots 28 V_{DC}$						
Options		2-wire: 4 ... 20 mA with communication interface <sup>3</sup> 3-wire: 0 ... 10 V / $V_S = 14 \dots 30 V_{DC}$ 0 ... 10 V with communication interface <sup>3</sup>						
<sup>3</sup> only possible with el. connection Binder series 723 (7-pin)								
Performance								
Accuracy <sup>4</sup>		IEC 60770: $\leq \pm 0.1$ % FSO						
performance after turn-down		no change of accuracy <sup>5</sup> for calculation use the following formula (for nominal pressure ranges $\leq 0.40$ bar see note 5): $\leq \pm [0.1 + 0.015 \times \text{turn-down}]$ % FSO with turn-down = nominal pressure range / adjusted range e.g. with a turn-down of 1:10 following accuracy is calculated: $\leq \pm (0.1 + 0.015 \times 10)$ % FSO i.e. accuracy is $\leq \pm 0.25$ % FSO						
Permissible load		current 2-wire: $R_{max} = [(V_S - V_S \text{ min}) / 0.02 \text{ A}] \Omega$ voltage 3-wire: $R_{min} = 10 \text{ k}\Omega$						
Influence effects		supply: 0.05 % FSO / 10 V load: 0.05 % FSO / k $\Omega$						
Long term stability		$\leq \pm (0.1 \times \text{turn-down})$ % FSO / year						
Response time		< 5 msec						
Adjustability		configuration of following parameters possible (interface / software necessary <sup>6</sup> ): - electronic damping: 0 ... 100 sec - offset: 0 ... 90 % FSO - turn down of span: max. 1:10						
<sup>4</sup> accuracy according to IEC 60770 – limit point adjustment (non-linearity, hysteresis, repeatability)								
<sup>5</sup> except nominal pressure ranges $\leq 0.40$ bar; for these calculation of accuracy is as follows:								
$\leq \pm (0.1 + 0.02 \times \text{turn-down})$ % FSO e.g. turn-down of 1:3: $\leq \pm (0.1 + 0.02 \times 3)$ % FSO i.e. accuracy is $\leq \pm 0.16$ % FSO								
<sup>6</sup> software, interface, and cable have to be ordered separately (software appropriate for Windows <sup>®</sup> 95, 98, 2000, NT Version 4.0 or higher, and XP)								
Thermal effects <sup>7</sup> (Offset and Span) / Permissible temperatures								
Tolerance band	[% FSO]	$\leq \pm (0.35 \times \text{turn-down})$			in compensated range			-20 ... 80 °C
TC, average	[% FSO / 10 K]	$\leq \pm (0.035 \times \text{turn-down})$			in compensated range			-20 ... 80 °C
Permissible temperatures <sup>8</sup>		medium: -40 ... 125 °C for filling fluid silicon oil -10 ... 125 °C for filling fluid food compatible oil electronics / environment: -25 ... 85 °C storage: -40 ... 100 °C						
Permissible temperature medium for cooling element 300°C		filling fluid silicon oil overpressure: -40 ... 300 °C vacuum: -40 ... 150 °C <sup>9</sup> filling fluid food compatible oil overpressure: -10 ... 250 °C vacuum: -10 ... 150 °C <sup>9</sup>						
<sup>7</sup> an optional cooling element can influence thermal effects for offset and span depending on installation position and filling conditions.								
<sup>8</sup> max. temperature of the medium for nominal pressure gauge > 0 bar: 150 °C for 60 minutes with a max. environmental temperature of 50 °C								
<sup>9</sup> also for $P_{abs} \leq 1$ bar								
Electrical protection								
Short-circuit protection		permanent						
Reverse polarity protection		no damage, but also no function						
Electromagnetic compatibility		emission and immunity according to EN 61326						
Filling fluids								
Standard		silicon oil						
Options		food compatible oil with FDA approval (Mobil DTE FM 32; Category Code: H1; NSF Registration No.: 130662) others on request						
Mechanical stability								
Vibration (DIN EN 60068-2-6)		G 1/2": 20 g RMS (25 ... 2000 Hz); others except G 1/2": 10 g RMS (25 ... 2000 Hz)						
Shock (DIN EN 60068-2-27)		G 1/2": 500 g / 1 msec; others except G 1/2": 100 g / 1 msec						

<b>Materials</b>		
Pressure port	stainless steel 1.4404 (316 L)	others on request
Housing	stainless steel 1.4404 (316 L)	
Option compact field housing	stainless steel 1.4305 (303), cable gland brass, nickel plated	others on request
Seals (O-ring)	standard: FKM (recommended for medium temperatures ≤ 200 °C) option: FFKM (recommended for medium temperatures > 200 °C) others on request	
Diaphragm	standard: stainless steel 1.4435 (316L) option: Hastelloy® C-276 (2.4819) and Tantalum on request	
Media wetted parts	pressure port, diaphragm	

<b>Explosion protection (only for 4 ... 20 mA / 2-wire)</b>		
Approval DX19-DMP 331Pi	IBExU 10 ATEX 1068 X zone 0: II 1G Ex ia IIC T4 Ga zone 20: II 1D Ex iaD 20 T 85 °C	
Safety technical max. values	U <sub>i</sub> = 28 V, I <sub>i</sub> = 93 mA, P <sub>i</sub> = 660 mW, C <sub>i</sub> ≈ 0 nF, L <sub>i</sub> ≈ 0 μH, the supply connections have an inner capacity of max. 27 nF to the housing	
Max. permissible temperature	-20 ... 65 °C	
Connecting cables (by factory)	cable capacitance: signal line/shield also signal line/signal line: 160 pF/m cable inductance: signal line/shield also signal line/signal line: 1 μH/m	

<b>Miscellaneous</b>		
Current consumption	signal output current: max. 25 mA signal output voltage: max. 7 mA	
Weight	approx. 200 g	
Installation position	any <sup>10</sup>	
Operational life	> 100 x 10 <sup>6</sup> pressure cycles	
CE-conformity	EMC Directive: 2004/108/EC	

<sup>10</sup> Pressure transmitters are calibrated in a vertical position with the pressure connection down. If this position is changed on installation there can be slight deviations in the zero point for pressure ranges P<sub>N</sub> ≤ 1 bar.

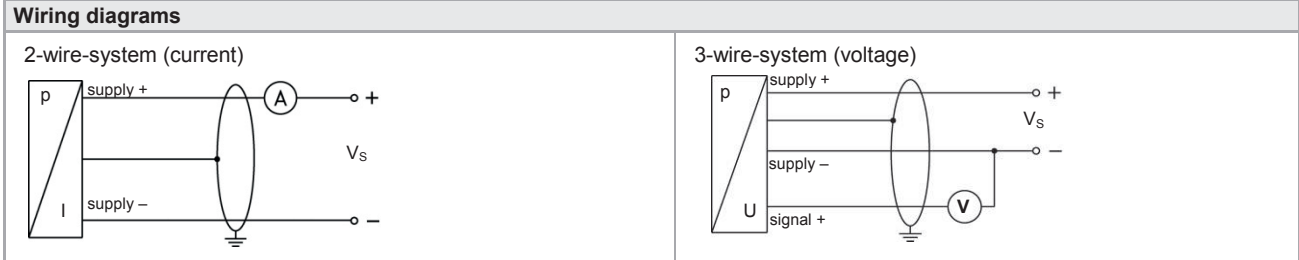

<b>Pin configuration</b>						
Electrical connections	ISO 4400	Binder 723 (5-pin)	Binder 723 (7-pin)	M12x1/ metal (4-pin)	field housing	cable colours (DIN 47100)
Supply +	1	3	3	3	IN +	wh (white)
Supply -	2	4	1	1	IN -	bn (brown)
Signal + (only for 3-wire)	3	1	6	-	OUT +	gr (green)
shield	ground pin	5	2	4	⏏	ye/gn yellow / green
Communication interface <sup>11</sup>	RxD	-	4	-	-	-
	TxD	-	5	-	-	-
	GND	-	7	-	-	-

<sup>11</sup> may not be connected directly with the PC (the suitable adapter is available as accessory)

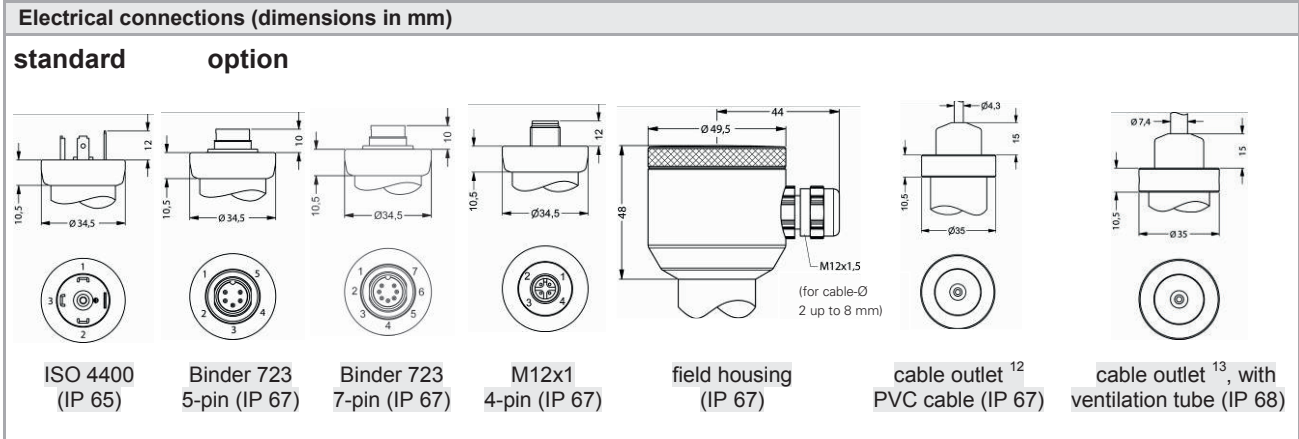

<sup>12</sup> standard: 2 m PVC cable (without ventilation tube, permissible temperature: -5 ... 70 °C)

<sup>13</sup> different cable types and lengths available, permissible temperature depends on kind of cable

### Mechanical connection (dimensions in mm)

#### standard

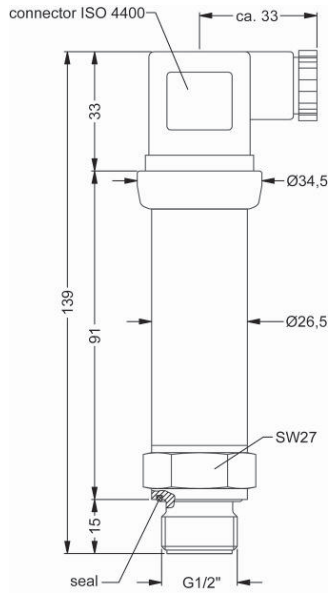

G1/2" flush DIN 3852

#### option

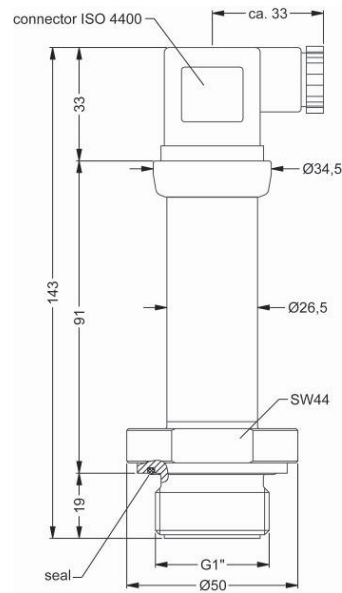

G1" flush DIN 3852

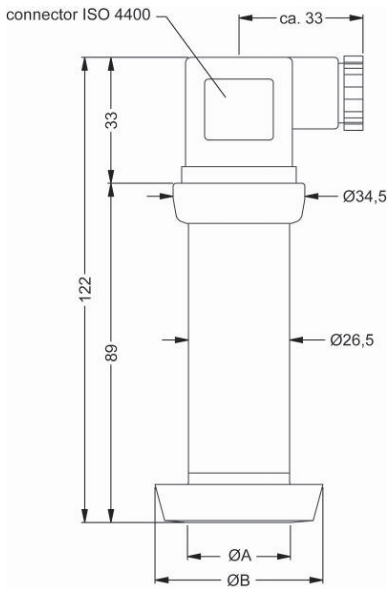

dairy pipe (DIN 11851)

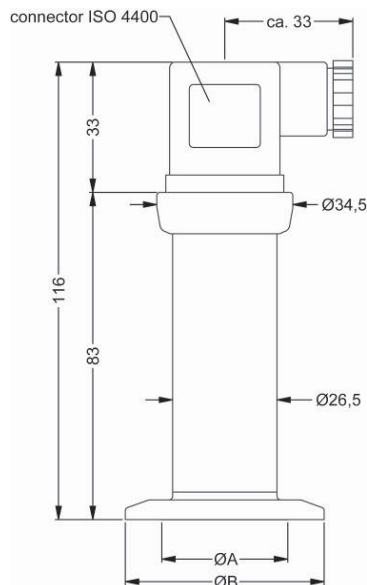

Clamp (DIN 32676)

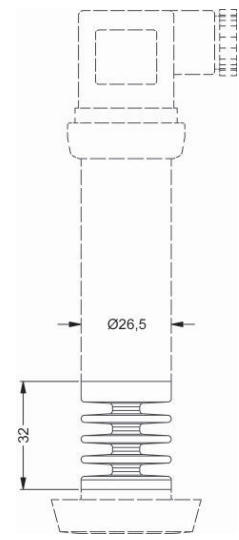

cooling element up to 300 °C

dimensions in mm			
size	DN 25	DN 40	DN 50
A	23	32	45
B	44	56	68.5
$P_N$ [bar]	≤ 40	≤ 40	≤ 25

dimensions in mm			
size	DN 25	DN 32	DN 50
A	23	32	45
B	50.5	50.5	64
$P_N$ [bar]	≤ 16	≤ 16	≤ 16

⇒ metric threads and others on request

Windows® is a registered trade mark of Microsoft Corporation

This document contains product specifications; properties are not guaranteed. Subject to change without notice.

### DMP 331Pi

□□□ - □□□□ - □ - □ - □□□ - □□□□ - □ - □ - □□□□

<b>Pressure</b>																				
	gauge	5	0	0																
	absolute <sup>1</sup>	5	0	1																
<b>Input</b>																				
	[bar]																			
	0.40 <sup>1</sup>	4	0	0	0															
	1.0	1	0	0	1															
	2.0	2	0	0	1															
	4.0	4	0	0	1															
	10	1	0	0	2															
	20	2	0	0	2															
	40	4	0	0	2															
	-0.40 ... 0.40	S	4	0	0															
	-1 ... 1	S	1	0	2															
	-1 ... 2	V	2	0	2															
	-1 ... 4	V	4	0	2															
	-1 ... 10	V	1	0	3															
	customer	9	9	9	9															consult
<b>Output</b>																				
	4 ... 20 mA / 2-wire																			
	Intrinsic safety 4 ... 20 mA / 2-wire																			
	0 ... 10 V / 3-wire																			
	customer																			consult
<b>Accuracy</b>																				
	0.1%																			
	customer																			consult
<b>Electrical connection</b>																				
	Male and female plug ISO 4400																			
	Male plug Binder series 723 (5-pin)																			
	Male plug Binder series 723 (7-pin) <sup>2</sup>																			
	Cable outlet with PVC-cable <sup>3</sup>																			
	Cable outlet <sup>4</sup>																			
	Male plug M12x1 (4-pin) / metal																			
	Compact field housing																			
	stainless steel 1.4305 <sup>5</sup>																			
	customer																			consult
<b>Mechanical connection</b>																				
	G1/2" with flush welded diaphragm (DIN 3852) <sup>6</sup>																			
	G1" with flush welded diaphragm (DIN 3852)																			
	Clamp DN 25 (DIN 32676)																			
	Clamp DN 32 (DIN 32676)																			
	Clamp DN 50 (DIN 32676)																			
	Dairy pipe DN 25 (DIN 11851) <sup>5</sup>																			
	Dairy pipe DN 40 (DIN 11851) <sup>5</sup>																			
	Dairy pipe DN 50 (DIN 11851) <sup>5</sup>																			
	customer																			consult
<b>Diaphragm</b>																				
	Stainless steel 1.4435 (316L)																			
	Hastelloy® C-276 (2.4819)																			consult
	Tantalum																			consult
	customer																			consult
<b>Seals</b>																				
	for clamp or dairy pipe: without																			
	for inch thread - standard: FKM																			
	for inch thread - option: FFKM																			
	customer																			consult
<b>Filling Fluids</b>																				
	silicon oil																			
	food compatible oil																			
	customer																			consult
<b>Special version</b>																				
	standard																			
	RS-232 interface <sup>7</sup>																			
	with cooling element up to 300 °C																			
	RS-232 interface and cooling element up to 300 °C <sup>7</sup>																			
	customer																			consult

<sup>1</sup> absolut pressure possible from 1 bar

<sup>2</sup> cable socket is included in delivery

<sup>3</sup> standard: 2 m PVC cable without ventilation tube (permissible temperature: -5 ... 70 °C), others on request

<sup>4</sup> cable with ventilation tube (code TR0 = PVC cable), different cable types and lengths available, price without cable

<sup>5</sup> The cup nut has to be mounted by production of pressure transmitter with electrical connection field housing and mechanical connection dairy pipe.

The cup nut has to be ordered as separate position.

<sup>6</sup> possible only for  $P_N \geq 1$  bar

<sup>7</sup> RS-232 interface only possible with el. connection Binder series 723 (7-pin)

Software, Interface and cable for DMP 331 Pi with option RS-232 have to be order separately

(Ordering code: CIS-G; Software appropriate for Windows® 95, 98, 2000, NT Version 4.0 or newer and XP)

Windows® is a registered trademark of Microsoft Corporation



## DMP 331i / DMP331i LMP 331 i

### Precision Pressure Transmitter / Screw-in transmitter

Stainless Steel Sensor

accuracy according to IEC 60770:  
0.1 % FSO

#### Nominal pressure

from 0 ... 400 mbar up to 0 ... 600 bar

#### Output signal

2-wire: 4 ... 20 mA

3-wire: 0 ... 10 V

others on request

#### Product characteristics

- ▶ thermal error in compensated range  
-20 ... 80 °C: 0.2 % FSO  
TC 0.02 % FSO / 10K
- ▶ communication interface for adjusting  
of offset, span and damping

#### Optional versions

- ▶ IS-versions  
Ex ia = intrinsically safe for gases and  
dusts
- ▶ adjustment of nominal pressure  
gauges (factory-provided)

The precision pressure transmitter DMP 331i and DMP 333i also the precision screw-in transmitter LMP 331i demonstrate the further development of our industrial pressure transmitters.

The signal processing of sensor signal is done by digital electronics with 16-bit analog digital converter. Consequently it is possible to conduct an active compensation and the transmitters with excellent measurements and exceptionally attractive price to offer on the market.

#### Preferred areas of use are DMP 331i / DMP 333i



Laboratory Techniques



Energy production (gas consumption  
and thermal energy measurement)

#### Preferred areas of use are LMP 331i



Chemical / petrochemical industry



Environmental Engineering  
(water / sewage / recycling)



## Technical Data

Pressure ranges DMP 331 i <sup>1</sup>								
Nominal pressure gauge / absolute	[bar]	0.4	1	2	4	10	20	40
Overpressure	[bar]	2	5	10	20	40	80	105
Burst pressure	[bar]	3	7,5	15	25	50	120	210

<sup>1</sup> On customer request we adjust the device within the turn-down-possibility by software on the required pressure range.

Vacuum ranges						
Nominal pressure	[bar]	-0.4 ... 0.4	-1 ... 1	-1 ... 2	-1 ... 4	-1 ... 10
Overpressure	[bar]	2	5	10	20	40
Burst pressure	[bar]	3	7.5	15	25	50

Pressure ranges DMP 333 i <sup>1</sup>						
Nominal pressure gauge / absolute	[bar]	60	100	200	400	600
Overpressure	[bar]	210	210	600	1000	1000
Burst pressure	[bar]	420	420	1000	1250	1250

<sup>1</sup> On customer request we adjust the device within the turn-down-possibility by software on the required pressure range.

Pressure ranges LMP 331 i <sup>1</sup>								
Nominal pressure gauge / absolute	[bar]	0.4	1	2	4	10	20	40
Level gauge	[mH <sub>2</sub> O]	4	10	20	40	100	200	400
Overpressure	[bar]	2	5	10	20	40	80	105
Burst pressure	[bar]	3	7.5	15	25	80	120	210

<sup>1</sup> On customer request we adjust the device within the turn-down-possibility by software on the required pressure range.

Output signal / Supply	
Standard	2-wire: 4 ... 20 mA / V <sub>S</sub> = 12 ... 36 V <sub>DC</sub>
Option IS-protection	2-wire: 4 ... 20 mA / V <sub>S</sub> = 14 ... 28 V <sub>DC</sub>
Options	2-wire: 4 ... 20 mA with communication interface <sup>2</sup> 3-wire: 0 ... 10 V / V <sub>S</sub> = 14 ... 36 V <sub>DC</sub> 0 ... 10 V with communication interface <sup>2</sup>

<sup>2</sup> only possible with el. connection Binder series 723 (7-pin)

Performance	
Accuracy	IEC 60770 <sup>3</sup> : $\leq \pm 0.1$ % FSO
performance after turn-down	no change of accuracy <sup>4</sup> for calculation use the following formula (for nominal pressure ranges $\leq 0.40$ bar see note 3): $\leq \pm [0.1 + 0.015 \times \text{turn-down}]$ % FSO with turn-down = nominal pressure range / adjusted range e.g. with a turn-down of 1:10 following accuracy is calculated: $\leq \pm (0.1 + 0.015 \times 10)$ % FSO i.e. accuracy is $\leq \pm 0.25$ % FSO
Permissible load	current 2-wire: $R_{\max} = [(V_S - V_S \text{ min}) / 0.02 \text{ A}] \Omega$ voltage 3-wire: $R_{\min} = 10 \text{ k}\Omega$
Influence effects	supply: 0.05 % FSO / 10 V load: 0.05 % FSO / k $\Omega$
Long term stability	$\leq \pm (0.1 \times \text{turn-down})$ % FSO / year
Response time	approx. 5 msec
Adjustability	configuration of following parameters possible (interface / software necessary <sup>5</sup> ): - electronic damping: 0 ... 100 sec - offset: 0 ... 90 % FSO - turn down of span: max. 1:10

<sup>3</sup> accuracy according to IEC 60770 – limit point adjustment (non-linearity, hysteresis, repeatability)

<sup>4</sup> except nominal pressure ranges  $\leq 0.40$  bar; for these calculation of accuracy is as follows:

$\leq \pm (0.1 + 0.02 \times \text{turn-down})$  % FSO e.g. turn-down of 1:3:  $\leq \pm (0.1 + 0.02 \times 3)$  % FSO i.e. accuracy is  $\leq \pm 0.16$  % FSO

<sup>5</sup> software, interface, and cable have to be ordered separately (software appropriate for Windows<sup>®</sup> 95, 98, 2000, NT Version 4.0 or higher, and XP)

Thermal effects (Offset and Span) / Permissible temperatures		
Tolerance band	[% FSO]	$\leq \pm (0.2 \times \text{turn-down})$ in compensated range -20 ... 80 °C
TC, average	[% FSO / 10 K]	$\pm (0.02 \times \text{turn-down})$ in compensated range -20 ... 80 °C
Permissible temperatures		medium: -25 ... 125 °C electronics / environment: -25 ... 85 °C storage: -40 ... 100 °C

Electrical protection	
Short-circuit protection	permanent
Reverse polarity protection	no damage, but also no function
Electromagnetic compatibility	emission and immunity according to EN 61326



Materials						
Pressure port	stainless steel 1.4404 (316 L)					
Housing	stainless steel 1.4404 (316 L)					
Seals	DMP 331i / LMP 331i: FKM DMP 333i: NBR optional: welded version <sup>6</sup> others on request					
Diaphragm	stainless steel 1.4435 (316L)					
Media wetted parts	pressure port, seals, diaphragm					
<sup>6</sup> welded version only with pressure ports according to EN 837; welded version not available with pressure ranges $\leq 0.16$ bar and $> 40$ bar						
Mechanical stability						
Vibration	10 g RMS (20 ... 2000 Hz)					
Shock	100 g / 11 msec.					
Explosion protection (only for 4 ... 20 mA / 2-wire)						
Approvals	DX19-DMP 331i DX19-DMP 333i DX19-LMP 331i					
	<b>IBExU 10 ATEX 1068 X / IECEx IBE 12.0027X</b> zone 0: II 1G Ex ia IIC T4 Ga zone 20: II 1D Ex ia IIIC T 85°C Da					
Safety technical max. values	$U_i = 28$ V, $I_i = 93$ mA, $P_i = 660$ mW, $C_i \approx 0$ nF, $L_i \approx 0$ $\mu$ H, the supply connections have an inner capacity of max. 27 nF to the housing					
Permissible temperatures for environment	in zone 0: -20 ... 60 °C with $p_{atm}$ 0.8 bar up to 1.1 bar in zone 1 or higher: -20 ... 65 °C					
Connecting cables (by factory)	cable capacitance: signal line/shield also signal line/signal line: 160 pF/m cable inductance: signal line/shield also signal line/signal line: 1 $\mu$ H/m					
Miscellaneous						
Current consumption	signal output current: max. 25 mA signal output voltage: max. 7 mA					
Weight	approx. 200 g					
Installation position	any <sup>7</sup>					
Operational life	$> 100 \times 10^6$ pressure cycles					
CE-conformity	EMC Directive: 2004/108/EC Pressure Equipment Directive: 97/23/EC (module A) <sup>8</sup>					
ATEX Directive	94/4/EG					
<sup>7</sup> Pressure transmitters are calibrated in a vertical position with the pressure connection down. If this position is changed on installation there can be slight deviations in the zero point for pressure ranges $P_N \leq 1$ bar.						
<sup>8</sup> This directive is only valid for devices with maximum permissible overpressure $> 200$ bar						
Wiring diagrams						
2-wire-system (current)	3-wire-system (voltage)					
Pin configuration						
Electrical connections	ISO 4400	Binder 723 (5-pin)	Binder 723 (7-pin)	M12x1/ metal (4-pin)	field housing	cable colours (DIN 47100)
Supply +	1	3	3	3	IN +	wh (white)
Supply -	2	4	1	1	IN -	bn (brown)
Signal + (only for 3-wire)	3	1	6	-	OUT +	gn (green)
shield	ground pin	5	2	4	$\perp$	ye/gn (yellow / green)
Communication interface <sup>9</sup>	RxD	-	4	-	-	-
	TxD	-	5	-	-	-
	GND	-	7	-	-	-
<sup>9</sup> may not be transmitted directly with the PC (the suitable adapter is available as accessory)						

## Electrical connections (dimensions in mm)

### standard

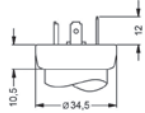

ISO 4400  
(IP 65)

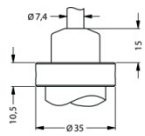

cable outlet with ventilation tube  
(IP 68)<sup>10</sup>

### option

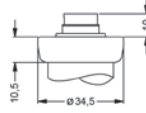

Binder Series 723 5-pin  
(IP 67)

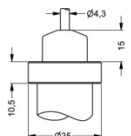

cable outlet with PVC cable  
(IP 67)<sup>11</sup>

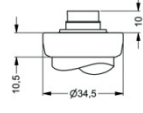

Binder Series 723 7-pin  
(IP 67)

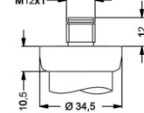

M12x1 4-pin  
(IP 67)

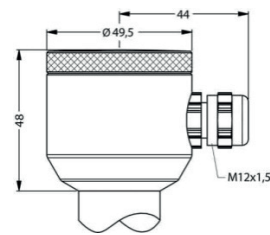

compact field housing  
(IP 67)

<sup>10</sup> different cable types and lengths available, permissible temperature depends on kind of cable  
<sup>11</sup> standard: 2 m PVC cable (without ventilation tube, permissible temperature: -5 ... 70 °C)

## Mechanical connection (dimensions in mm)

### standard

### DMP 331 i / DMP 333 i \*

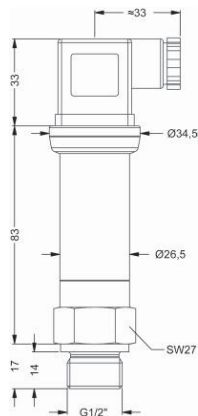

G1/2" DIN 3852

### LMP 331 i

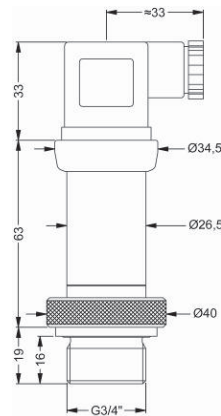

G3/4" DIN 3852

\* for nominal pressure  $P_N > 400$  bar increases the length of DMP 333i without IS-version by 19 mm and of DMP 333i with IS-version by 39 mm

### option for DMP 331 i and DMP 333 i

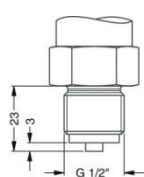

G1/2" EN 837

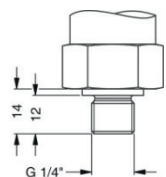

G1/4" DIN 3852

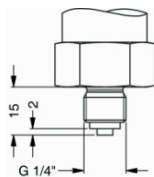

G1/4" EN 837

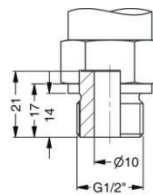

G1/2" open port

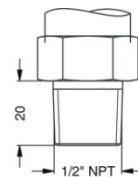

1/2" NPT

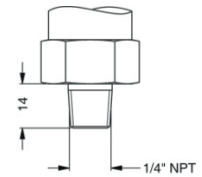

1/4" NPT

⇨ metric threads and others on request

Windows® is a registered trade mark of Microsoft Corporation

This document contains product specifications; properties are not guaranteed. Subject to change without notice.

## DMP 331i / DMP 333i / LMP 331i

## Ordering Code

## DMP 331i/ DMP 333i/ LMP 331i

<b>Pressure</b>															
For DMP 331i	gauge		1	1	0										
	absolute		1	1	1										
For DMP 333i	gauge <sup>1</sup>		1	3	0										
	absolute		1	3	1										
For LMP 331i	in bar		4	3	0										
	in mH <sub>2</sub> O		4	3	1										
<b>Input</b>															
		[mH <sub>2</sub> O]		[bar]											
For DMP 331i <sup>2</sup> or LMP 331i															
		4	0.40		4	0	0	0							
		10	1.0		1	0	0	1							
		20	2.0		2	0	0	1							
		40	4.0		4	0	0	1							
		100	10		1	0	0	2							
		200	20		2	0	0	2							
		400	40		4	0	0	2							
For DMP 333i <sup>2</sup>															
		60			6	0	0	2							
		100			1	0	0	3							
		200			2	0	0	3							
		400			4	0	0	3							
		600			6	0	0	3							
For DMP 331i															
		-0.40 ... 0.40			S	4	0	0							
		-1 ... 1			S	1	0	2							
		-1 ... 2			V	2	0	2							
		-1 ... 4			V	4	0	2							
		-1 ... 10			V	1	0	3							
		customer			9	9	9	9							consult
<b>Output</b>															
		4 ... 20 mA / 2-wire						1							
		Intrinsic safety 4 ... 20 mA / 2-wire						E							
		0 ... 10 V / 3-wire						3							
		customer						9							consult
<b>Accuracy (at nominal pressure)</b>															
		0.1 %						1							
		customer						9							consult
<b>Electrical connection</b>															
		Male and female plug ISO 4400						1	0	0					
		Male plug Binder series 723 (5-pin)						2	0	0					
		Compact field housing						8	5	0					
		stainless steel 1.4404 (316L)													
		Male and female plug						A	0	0					
		Binder series 723 (7-pin)													
		Male plug M12x1 (4-pin) / metal						M	1	0					
		Cable outlet with PVC cable <sup>3</sup>						T	A	0					
		Cable outlet <sup>4</sup>						T	R	0					
		customer						9	9	9					consult
<b>Mechanical connection</b>															
For DMP 331i or DMP 333i															
		G1/2" DIN 3852						1	0	0					
		G1/2" EN 837						2	0	0					
		G1/4" DIN 3852						3	0	0					
		G1/4" EN 837						4	0	0					
		G1/2" DIN 3852 with <sup>5,6</sup>													
		flush sensor						F	0	0					
		G1/2" DIN 3852 open pressure port <sup>6</sup>						H	0	0					
		1/2" NPT						N	0	0					
		1/4" NPT						N	4	0					
For LMP 331i															
		G3/4" DIN 3852 with flush sensor						K	0	0					
		customer						9	9	9					consult
<b>Seals</b>															
For DMP 331i or LMP 331i															
		FKM						1							
		without (welded version) <sup>7</sup>						2							
For DMP 333i															
		NBR						5							
		customer						9							consult
<b>Special version</b>															
		standard						1	1	1					
		RS-232 interface <sup>8</sup>						1	2	1					
		customer						9	9	9					consult

<sup>1</sup> measurement starts with ambient pressure

<sup>2</sup> pressure ranges ≤ 40 bar as DMP 331i; pressure ranges > 40 bar as DMP 333i

<sup>3</sup> standard: 2 m PVC cable without ventilation tube (permissible temperature: -5 ... 70 °C), optionally cable with ventilation tube

<sup>4</sup> cable with ventilation tube (code TR0 = PVC cable), different cable types and lengths available, price without cable

<sup>5</sup> Mechanical connection G1/2" DIN 3852 flush impossible for vacuum ranges

<sup>6</sup> only possible for DMP 331i

<sup>7</sup> welded version only with pressure ports according to EN 837; not possible with pressure ranges ≤ 0.16 bar and > 40 bar

<sup>8</sup> RS-232 interface only possible with el. connection Binder series 723 (7pin)

Software, Interface and cable for DMP 331i, DMP 333i and LMP 331i with option RS-232 have to be order separately

(Ordering code: CIS-G; Software appropriate for Windows® 95, 98, 2000, NT Version 4.0 or newer and XP)

Windows® is a registered trademark of Microsoft Corporation

This document contains product specifications; properties are not guaranteed. Detailed information about options are defined in the datasheet. Subject to change without notice.



# DMP 343

## Industrial Pressure Transmitter

Without Media Isolation

accuracy according to IEC 60770:  
0,35 % FSO

### Nominal pressure

from 0 ... 10 mbar up to 0 ... 1000 mbar

### Product characteristics

- ▶ excellent linearity
- ▶ small thermal effect
- ▶ excellent long term stability



### Optional versions

- ▶ IS-version:  
Ex ia = intrinsically safe for gases and dusts
- ▶ SIL 2 application according to IEC 61508 / IEC 61511
- ▶ different electrical and mechanical connections
- ▶ customer specific versions

The pressure transmitter DMP 343 has been especially designed for the measurement of very low gauge pressure and for vacuum applications. Permissible media are gases, pressurized air and non-aggressive low viscos oils.

The DMP 343 features excellent thermal behaviour and outstanding long term stability. A variety of standard output signals as well as mechanical and electrical connections make the DMP 343 covering a wide field of applications.

### Preferred areas of use are

-  Plant and Machine Engineering
-  Heating and Air Conditioning



Input pressure range														
Nominal pressure gauge	[mbar]	-1000 ... 0	10	16	25	40	60	100	160	250	400	600	1000	
Overpressure	[bar]	3	0.2	0.2	0.2	0.5	0.5	1	2	3	3	3	3	
Burst pressure	[bar]	5	0.3	0.3	0.3	0.75	0.75	1.5	3	5	5	5	5	
Output signal / Supply														
Standard		2-wire: 4 ... 20 mA / $V_S = 8 \dots 32 V_{DC}$												
Option IS-protection		2-wire: 4 ... 20 mA / $V_S = 10 \dots 28 V_{DC}$												
Options 3-wire		3-wire: 0 ... 20 mA / $V_S = 14 \dots 30 V_{DC}$ 0 ... 10 V / $V_S = 14 \dots 30 V_{DC}$												
Performance														
Accuracy <sup>1</sup>		standard: $\leq \pm 0.35 \% \text{ FSO}$ nominal pressure $\leq 100 \text{ mbar}$ : $\leq \pm 0.50 \% \text{ FSO}$												
Permissible load		current 2-wire: $R_{\max} = [(V_S - V_{S \text{ min}}) / 0.02 \text{ A}] \Omega$ current 3-wire: $R_{\max} = 500 \Omega$ voltage 3-wire: $R_{\min} = 10 \text{ k}\Omega$												
Influence effects		supply: 0.05 % FSO / 10 V load: 0.05 % FSO / $\text{k}\Omega$												
Response time		2-wire: $\leq 10 \text{ msec}$ 3-wire: $\leq 3 \text{ msec}$												
<sup>1</sup> accuracy according to IEC 60770 – limit point adjustment (non-linearity, hysteresis, repeatability)														
Thermal effects (Offset and Span)														
Nominal pressure $P_N$	[mbar]	-1000 ... 0	$\leq 100$				$\leq 400$				$> 400$			
Tolerance band	[% FSO]	$\leq \pm 0.75$	$\leq \pm 1.5$				$\leq \pm 1$				$\leq \pm 0.75$			
in compensated range	[°C]	-20 ... 85	0 ... 50				0 ... 70				-20 ... 85			
Permissible temperatures														
Permissible temperatures		medium: -40 ... 125 °C electronics / environment: -40 ... 85 °C storage: -40 ... 100 °C												
Electrical protection														
Short-circuit protection		permanent												
Reverse polarity protection		no damage, but also no function												
Electromagnetic compatibility		emission and immunity according to EN 61326												
Mechanical stability														
Vibration		10 g RMS (25 ... 2000 Hz)				according to DIN EN 60068-2-6								
Shock		500 g / 1 msec				according to DIN EN 60068-2-27								
Materials														
Pressure port		stainless steel 1.4404 (316L)												
Housing		stainless steel 1.4404 (316L)												
Seals (media wetted)		FKM												
Sensor		stainless steel 1.4404 (316L), silicon, epoxy or RTV, mineral glass												
Media wetted parts		pressure port, seals, sensor												
Explosion protection (only for 4 ... 20 mA / 2-wire)														
Approvals DX19-DMP 343		IBExU 10 ATEX 1068 X / IECEx IBE 12.0027X zone 0: II 1G Ex ia IIC T4 Ga zone 20: II 1D Ex ia IIIC T 85°C Da												
Safety technical maximum values		$U_i = 28 \text{ V}$ , $I_i = 93 \text{ mA}$ , $P_i = 660 \text{ mW}$ , $C_i \approx 0 \text{ nF}$ , $L_i \approx 0 \text{ }\mu\text{H}$ , the supply connections have an inner capacity of max. 27 nF opposite the housing												
Permissible temperatures for environment		in zone 0: -20 ... 60 °C with $p_{\text{atm}}$ 0.8 bar up to 1.1 bar in zone 1 or higher: -20 ... 70 °C												
Connecting cables (by factory)		cable capacitance: signal line/shield also signal line/signal line: 160 pF/m cable inductance: signal line/shield also signal line/signal line: 1 $\mu\text{H}/\text{m}$												
Miscellaneous														
Option SIL 2 application		according to IEC 61508 / IEC 61511												
Current consumption		signal output current: max. 25 mA signal output voltage: max. 7 mA												
Weight		approx. 140 g												
Installation position		any												
CE-conformity		EMC Directive: 2004/108/EC												
ATEX Directive		94/4/EG												

### Wiring diagrams

2-wire-system (current)

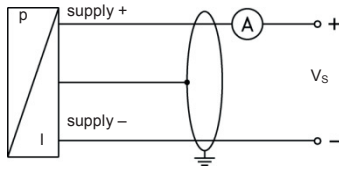

3-wire-system (current / voltage)

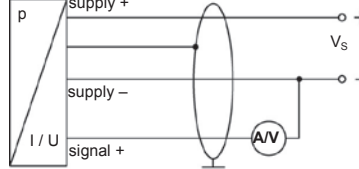

### Pin configuration

Electrical connection	ISO 4400	Binder 723 (5-pin)	M12x1 / metal (4-pin)	field housing	cable colours (DIN 47100)
Supply +	1	3	1	IN +	wh (white)
Supply -	2	4	2	IN -	bn (brown)
Signal + (only for 3-wire)	3	1	3	OUT+	gn (green)
Shield	ground pin	5	4	⊥	ye/gn (yellow / green)

### Electrical connections (dimensions in mm)

standard

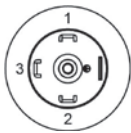
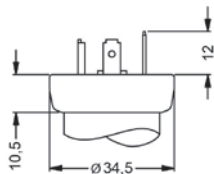

ISO 4400 (IP 65)

option

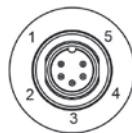
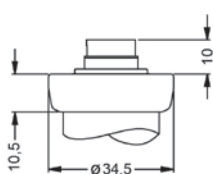

Binder Series 723 5-pin (IP 67)

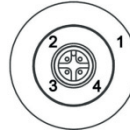
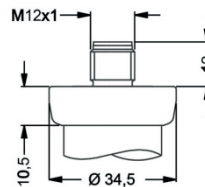

M12x1 4-pin (IP 67)

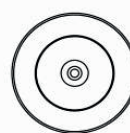
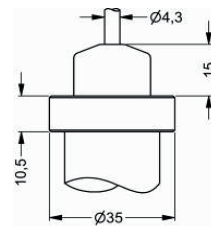

cable outlet with PVC cable (IP 67)<sup>2</sup>

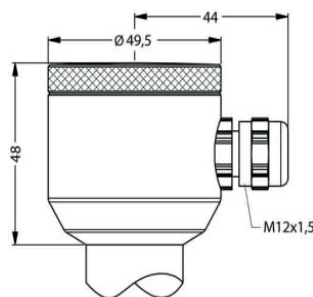

compact field housing (IP 67)

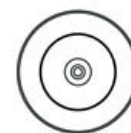
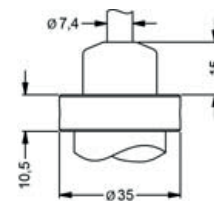

cable outlet, cable with ventilation tube (IP 68)<sup>3</sup>

⇒ universal field housing stainless steel 1.4404 (316 L) with cable gland M20x1.5 (ordering code 880) and other versions on request

<sup>2</sup> standard: 2 m PVC cable without ventilation tube (permissible temperature: -5 ... 70°C)

<sup>3</sup> different cable types and lengths available, permissible temperature depends on kind of cable

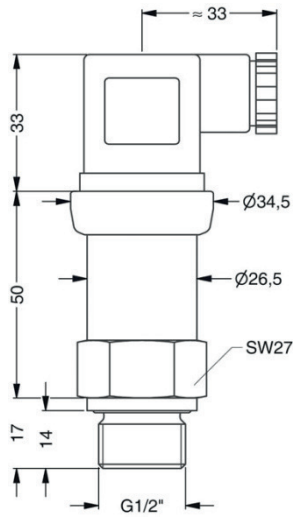
**Mechanical connection (dimensions in mm)**
**standard**

G1/2" DIN 3852  
with ISO 4400

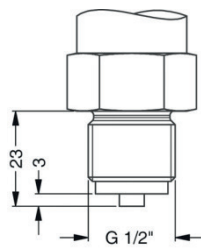
**option**

G1/2" EN 837

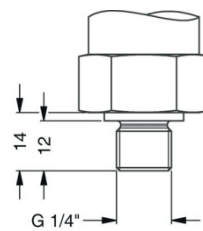

G1/4" DIN 3852

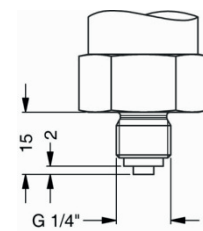

G1/4" EN 837

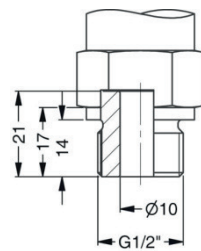

G1/2" open port

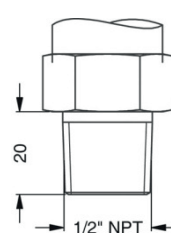

1/2" NPT

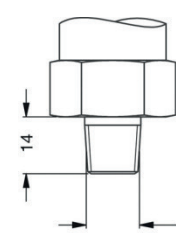

1/4" NPT

⇒ metric threads and others on request



### DMP 343



<b>Pressure</b>										
	gauge	1	0	0						
<b>Input</b>										
	[mbar]									
	10	0	1	0	0					
	16	0	1	6	0					
	25	0	2	5	0					
	40	0	4	0	0					
	60	0	6	0	0					
	100	1	0	0	0					
	160	1	6	0	0					
	250	2	5	0	0					
	400	4	0	0	0					
	600	6	0	0	0					
	1000	1	0	0	1					
	-1000 ... 0	X	1	0	2					
	customer	9	9	9	9					consult
<b>Output</b>										
	4 ... 20 mA / 2-wire					1				
	0 ... 20 mA / 3-wire					2				
	0 ... 10 V / 3-wire					3				
	Intrinsic safety 4 ... 20 mA / 2-wire					E				
	customer					9				consult
<b>Accuracy</b>										
	standard for $P_N > 100$ mbar	0.35 %				3				
	standard for $P_N \leq 100$ mbar	0.5 %				5				
<b>Electrical connection</b>										
	Male and female plug ISO 4400					1	0	0		
	Male plug Binder series 723 (5-pin)					2	0	0		
	Cable outlet with PVC cable <sup>1</sup>					T	A	0		
	Cable outlet <sup>2</sup>					T	R	0		
	Male plug M12x1 (4-pin) / metal					M	1	0		
	Compact field housing									
	stainless steel 1.4305					8	5	0		
	customer					9	9	9		consult
<b>Mechanical connection</b>										
	G1/2" DIN 3852					1	0	0		
	G1/2" EN 837					2	0	0		
	G1/4" DIN 3852					3	0	0		
	G1/4" EN 837					4	0	0		
	G1/2" DIN 3852 open pressure port					H	0	0		
	1/2" NPT					N	0	0		
	1/4" NPT					N	4	0		
	customer <sup>3</sup>					9	9	9		consult
<b>Seals</b>										
	FKM							1		
	customer							9		consult
<b>Special version</b>										
	standard							0	0	0
	customer							9	9	9
										consult

<sup>1</sup> standard: 2 m PVC cable without ventilation tube (permissible temperature: -5 ... 70 °C), optionally cable with ventilation tube

<sup>2</sup> cable with ventilation tube (code TR0 = PVC cable), different cable types and lengths available, price without cable

<sup>3</sup> metric threads and others on request



# DMP 331

## Industrial Pressure Transmitter for Low Pressure

### Stainless Steel Sensor

accuracy according to IEC 60770:  
standard: 0.35 % FSO  
option: 0.25 / 0.1 % FSO

#### Nominal pressure

from 0 ... 100 mbar up to 0 ... 40 bar

#### Output signals

2-wire: 4 ... 20 mA

3-wire: 0 ... 20 mA / 0 ... 10 V

others on request

#### Special characteristic

- ▶ perfect thermal behaviour
- ▶ excellent long term stability
- ▶ pressure port  
G 1/2" flush from 100 mbar

#### Optional versions

- ▶ IS-version  
Ex ia = intrinsically safe for gases and dusts
- ▶ SIL 2-according to  
IEC 61508 / IEC 61511
- ▶ pressure sensor welded
- ▶ customer specific versions

The pressure transmitter DMP 331 can be used in all industrial areas when the medium is compatible with stainless steel 1.4404 (316 L) or 1.4435 (316 L). Additional are different elastomer seals as well as a helium tested welded version available.

The modulare concept of the device allows to combine different stainless steel sensors and electronic modules with a variety of electrical and mechanical versions. Thus a diversity of variations is created, meeting almost all requirements in industrial applications.

#### Preferred areas of use are



Plant and Machine Engineering



Environmental Engineering  
(water - sewage - recycling)



Energy Industry



Input pressure range									
Nominal pressure gauge / abs.	[bar]	-1...0	0.10	0.16	0.25	0.40	0.60	1	1.6
Overpressure	[bar]	5	0.5	1	1	2	5	5	10
Burst pressure $\geq$	[bar]	7.5	1.5	1.5	1.5	3	7.5	7.5	15

Nominal pressure gauge / abs.	[bar]	2.5	4	6	10	16	25	40
Overpressure	[bar]	10	20	40	40	80	80	105
Burst pressure $\geq$	[bar]	15	25	50	50	120	120	210
Vacuum resistance		P <sub>N</sub> $\geq$ 1 bar: unlimited vacuum resistance P <sub>N</sub> < 1 bar: on request						

Output signal / Supply	
Standard	2-wire: 4 ... 20 mA / V <sub>S</sub> = 8 ... 32 V <sub>DC</sub>
Option IS-protection	2-wire: 4 ... 20 mA / V <sub>S</sub> = 10 ... 28 V <sub>DC</sub>
Options 3-wire	3-wire: 0 ... 20 mA / V <sub>S</sub> = 14 ... 30 V <sub>DC</sub> 0 ... 10 V / V <sub>S</sub> = 14 ... 30 V <sub>DC</sub>

Performance	
Accuracy <sup>1</sup>	standard: nominal pressure < 0.4 bar: $\leq \pm 0.5$ % FSO nominal pressure $\geq$ 0.4 bar: $\leq \pm 0.35$ % FSO option 1: nominal pressure $\geq$ 0.4 bar: $\leq \pm 0.25$ % FSO option 2: for all nominal pressure: $\leq \pm 0.1$ % FSO
Permissible load	current 2-wire: R <sub>max</sub> = [(V <sub>S</sub> - V <sub>S</sub> min) / 0.02 A] $\Omega$ current 3-wire: R <sub>max</sub> = 500 $\Omega$ voltage 3-wire: R <sub>min</sub> = 10 k $\Omega$
Influence effects	supply: 0.05 % FSO / 10 V load: 0.05 % FSO / k $\Omega$
Long term stability	$\leq \pm 0.1$ % FSO / year at reference conditions
Response time	2-wire: $\leq 10$ msec 3-wire: $\leq 3$ msec

<sup>1</sup> accuracy according to IEC 60770 – limit point adjustment (non-linearity, hysteresis, repeatability)

Thermal effects (Offset and Span)				
Nominal pressure P <sub>N</sub>	[bar]	-1 ... 0	< 0.40	$\geq 0.40$
Tolerance band	[% FSO]	$\leq \pm 0.75$	$\leq \pm 1$	$\leq \pm 0.75$
in compensated range	[°C]	-20 ... 85	0 ... 70	-20 ... 85

Permissible temperatures	
Permissible temperatures	medium: -40 ... 125 °C electronics / environment: -40 ... 85 °C storage: -40 ... 100 °C

Electrical protection	
Short-circuit protection	permanent
Reverse polarity protection	no damage, but also no function
Electromagnetic compatibility	emission and immunity according to EN 61326

Mechanical stability	
Vibration	10 g RMS (25 ... 2000 Hz) according to DIN EN 60068-2-6
Shock	500 g / 1 msec according to DIN EN 60068-2-27

Materials	
Pressure port	stainless steel 1.4404 (316 L)
Housing	stainless steel 1.4404 (316 L)
Option compact field housing	stainless steel 1.4305 (303), cable gland brass, nickel plated others on request
Seals (media wetted)	standard: FKM options: EPDM NBR welded version <sup>2</sup> others on request
Diaphragm	stainless steel 1.4435 (316 L)
Media wetted parts	pressure port, seals, diaphragm

<sup>2</sup> welded version only with pressure ports according to EN 837

Explosion protection (only for 4 ... 20 mA / 2-wire)	
Approvals DX19-DMP 331	<b>IBExU 10 ATEX 1068 X / IECEx IBE 12.0027X</b> zone 0: II 1G Ex ia IIC T4 Ga zone 20: II 1D Ex ia IIIC T 85°C Da
Safety technical maximum values	U <sub>i</sub> = 28 V, I <sub>i</sub> = 93 mA, P <sub>i</sub> = 660 mW, C <sub>i</sub> $\approx$ 0 nF, L <sub>i</sub> $\approx$ 0 $\mu$ H, the supply connections have an inner capacity of max. 27 nF to the housing
Permissible temperatures for environment	in zone 0: -20 ... 60 °C with p <sub>atm</sub> 0.8 bar up to 1.1 bar in zone 1 or higher: -20 ... 70 °C
Connecting cables (by factory)	cable capacitance: signal line/shield also signal line/signal line: 160 pF/m cable inductance: signal line/shield also signal line/signal line: 1 $\mu$ H/m

Miscellaneous	
Option SIL <sup>3</sup> 2	according to IEC 61508 / IEC 61511
Current consumption	signal output current: max. 25 mA      signal output voltage: max. 7 mA
Weight	approx. 140 g
Installation position	any <sup>4</sup>
Operational life	> 100 x 10 <sup>6</sup> pressure cycles
CE-conformity	EMC Directive: 2004/108/EC
ATEX Directive	94/4/EG

<sup>3</sup> only for 4 ... 20 mA / 2-wire, not in combination with the accuracy 0.1%

<sup>4</sup> Pressure transmitters are calibrated in a vertical position with the pressure connection down. If this position is changed on installation there can be slight deviations in the zero point for pressure ranges  $P_N \leq 1$  bar.

### Wiring diagrams

2-wire-system (current)

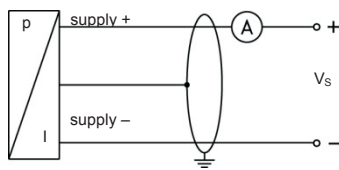

3-wire-system (current / voltage)

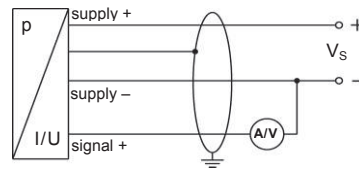

### Pin configuration

Electrical connection	ISO 4400	Binder 723 (5-pin)	M12x1 / metal (4-pin)	field housing	cable colours (DIN 47100)
Supply +	1	3	1	IN +	wh (white)
Supply -	2	4	2	IN -	bn (brown)
Signal + (for 3-wire)	3	1	3	OUT+	gn (green)
Shield	ground pin	5	4	⊥	ye/gn (yellow / green)

### Electrical connections (dimensions in mm)

standard

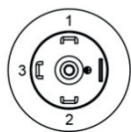
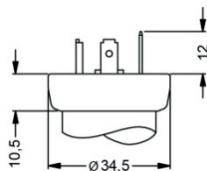

ISO 4400 (IP 65)

option

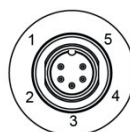
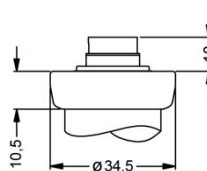

Binder Series 723 5-pin (IP 67)

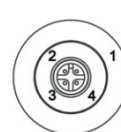
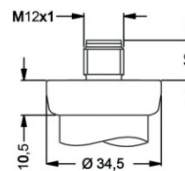

M12x1 4-pin (IP 67)

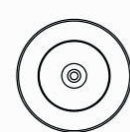
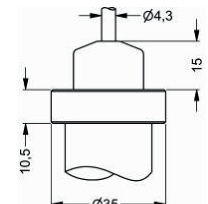

cable outlet with PVC cable (IP 67)<sup>5</sup>

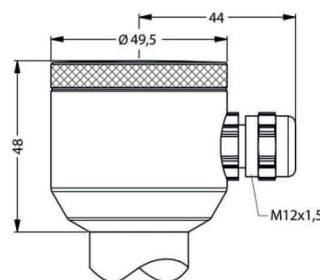

compact field housing (IP 67)

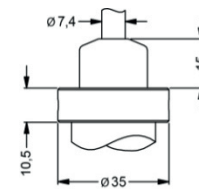

cable outlet, cable with ventilation tube (IP 68)<sup>6</sup>

⇒ universal field housing stainless steel 1.4404 (316 L) with cable gland M20x1.5 (ordering code 880) and other versions on request

<sup>5</sup> standard: 2 m PVC cable without ventilation tube (permissible temperature: -5 ... 70°C)

<sup>6</sup> different cable types and lengths available, permissible temperature depends on kind of cable

**Mechanical connections (dimensions in mm)**

standard for accuracy 0.35 / 0.25 %

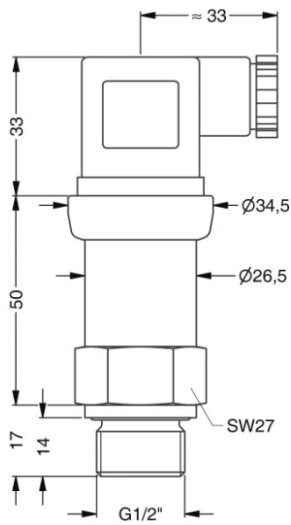

G1/2" DIN 3852  
with ISO 4400

standard for accuracy 0.1 %;  
SIL- and SIL-IS-version

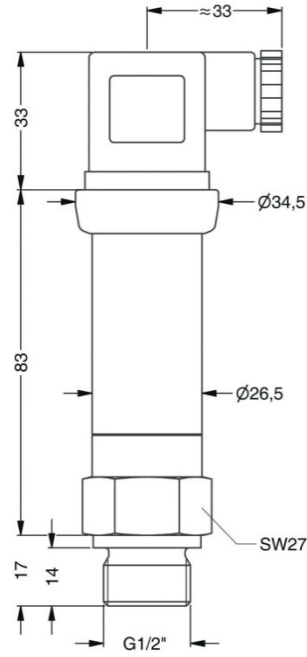

G1/2" DIN 3852  
with ISO 4400

option

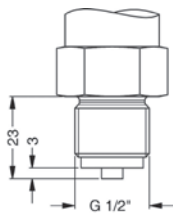

G1/2" EN 837

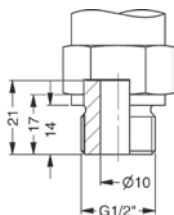

G1/2" open port

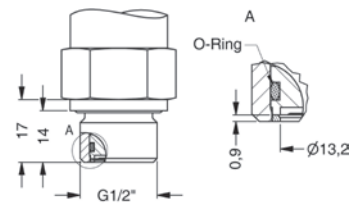

G1/2" DIN 3852  
with flush sensor

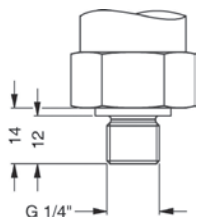

G1/4" DIN 3852

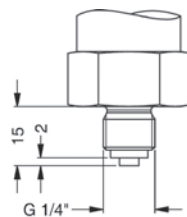

G1/4" EN 837

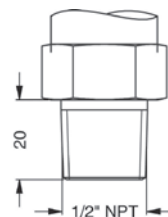

1/2" NPT

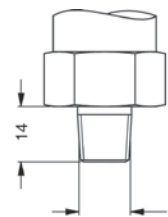

1/4" NPT

⇒ metric threads and other versions on request

## DMP 331



Pressure															
	gauge	1	1	0											
	absolute	1	1	1											
Input		[bar]													
	0.10	1	0	0	0										
	0.16	1	6	0	0										
	0.25	2	5	0	0										
	0.40	4	0	0	0										
	0.60	6	0	0	0										
	1.0	1	0	0	1										
	1.6	1	6	0	1										
	2.5	2	5	0	1										
	4.0	4	0	0	1										
	6.0	6	0	0	1										
	10	1	0	0	2										
	16	1	6	0	2										
	25	2	5	0	2										
	40	4	0	0	2										
	-1 ... 0	X	1	0	2										
	customer	9	9	9	9										consult
Output															
	4 ... 20 mA / 2-wire					1									
	0 ... 20 mA / 3-wire					2									
	0 ... 10 V / 3-wire					3									
	Intrinsic safety 4 ... 20 mA / 2-wire					E									
	SIL2 4 ... 20 mA / 2-wire					1S									
	SIL2 with intrinsic safety					ES									
	4 ... 20 mA / 2-wire														
	customer					9									consult
Accuracy															
	standard for P <sub>N</sub> ≥ 0.4 bar	0.35 %				3									
	standard for P <sub>N</sub> < 0.4 bar	0.5 %				5									
	option 1 for P <sub>N</sub> ≥ 0.4 bar	0.25 %				2									
	option 2	0.1 % <sup>1</sup>				1									
	customer					9									consult
Electrical connection															
	Male and female plug ISO 4400					1	0	0							
	Male plug Binder series 723 (5-pin)					2	0	0							
	Cable outlet with PVC cable <sup>2</sup>					T	A	0							
	Cable outlet <sup>3</sup>					T	R	0							
	Male plug M12x1 (4-pin) / metal					M	1	0							
	Compact field housing														
	stainless steel 1.4305					8	5	0							
	customer					9	9	9							consult
Mechanical connection															
	G1/2" DIN 3852					1	0	0							
	G1/2" EN 837					2	0	0							
	G1/4" DIN 3852					3	0	0							
	G1/4" EN 837					4	0	0							
	G1/2" DIN 3852														
	with flush sensor					F	0	0							
	G1/2" DIN 3852 open pressure port					H	0	0							
	1/2" NPT					N	0	0							
	1/4" NPT					N	4	0							
	customer					9	9	9							consult
Seals															
	FKM								1						
	EPDM								3						
	NBR								5						
	without (welded version) <sup>4</sup>								2						
	customer								9						consult
Special version															
	standard								0	0	0				
	customer								9	9	9				consult

<sup>1</sup> not in combination with SIL<sup>2</sup> standard: 2 m PVC cable without ventilation tube (permissible temperature: -5 ... 70°C), others on request<sup>3</sup> cable with ventilation tube (code TR0 = PVC cable), different cable types and lengths available, price without cable<sup>4</sup> welded version only with pressure ports according to EN 837



# DMP 333

## Industrial Pressure Transmitter For High Pressure

Stainless Steel Sensor

accuracy according to IEC 60770:  
standard: 0.35 % FSO  
option: 0.25 / 0.1 % FSO

### Nominal pressure

from 0 ... 60 bar up to 0 ... 600 bar

### Output signals

2-wire: 4 ... 20 mA

3-wire: 0 ... 20 mA / 0 ... 10 V

others on request

### Special characteristics

- ▶ excellent long-term stability, also with high dynamic pressure loads
- ▶ insensitive to pressure peaks
- ▶ high overpressure capability



### Optional versions

- ▶ IS-version  
Ex ia = intrinsically safe for gases and dusts
- ▶ SIL 2 version  
according to IEC 61508 / IEC 61511
- ▶ customer specific versions

The pressure transmitter type DMP 333 has been especially designed for use in hydraulic applications with high static and dynamic pressure. The transmitter is characterized by an excellent long term stability, also under fast changing pressure as well as positive and negative pressure peaks.

The modular concept of the device allows to combine different stainless steel sensors and electronic modules with a variety of electrical and mechanical versions. Thus a diversity of variations is created, meeting almost all requirements in hydraulic applications.

### Preferred areas of use are

- 
 Plant and Machine Engineering
  - machine tools
  - hydraulic presses
  - injection moulding machine
  - handling equipment
  - elevated platforms
  - test benches
- 
 Mobile Hydraulics





Input pressure range							
Nominal pressure gauge <sup>1</sup> / abs.	[bar]	60	100	160	250	400	600
Overpressure	[bar]	210	600	600	1000	1000	1000
Burst pressure $\geq$	[bar]	420	1000	1000	1250	1250	1250

<sup>1</sup> measurement starts with ambient pressure

Output signal / Supply	
Standard	2-wire: 4 ... 20 mA / $V_S = 8 \dots 32 V_{DC}$
Option IS-protection	2-wire: 4 ... 20 mA / $V_S = 10 \dots 28 V_{DC}$
Options 3-wire	3-wire: 0 ... 20 mA / $V_S = 14 \dots 30 V_{DC}$ 0 ... 10 V / $V_S = 14 \dots 30 V_{DC}$

Performance	
Accuracy <sup>2</sup>	standard: $\leq \pm 0.35\%$ FSO option 1: $\leq \pm 0.25\%$ FSO option 2: $\leq \pm 0.1\%$ FSO
Permissible load	current 2-wire: $R_{max} = [(V_S - V_S \text{ min}) / 0.02 \text{ A}] \Omega$ current 3-wire: $R_{max} = 500 \Omega$ voltage 3-wire: $R_{min} = 10 \text{ k}\Omega$
Influence effects	supply: 0.05 % FSO / 10 V load: 0.05 % FSO / k $\Omega$
Long term stability	$\leq \pm 0.1\%$ FSO / year at reference conditions
Response time	2-wire: $\leq 10$ msec 3-wire: $\leq 3$ msec

<sup>2</sup> accuracy according to IEC 60770 – limit point adjustment (non-linearity, hysteresis, repeatability)

Thermal effects (Offset and Span)	
Tolerance band	$\leq \pm 0.75\%$ FSO
in compensated range	0 ... 70 °C

Permissible temperatures	
Permissible temperatures	medium: -40 ... 125 °C electronics / environment: -40 ... 85 °C storage: -40 ... 100 °C

Electrical protection	
Short-circuit protection	permanent
Reverse polarity protection	no damage, but also no function
Electromagnetic compatibility	emission and immunity according to EN 61326

Mechanical stability	
Vibration	10 g RMS (25 ... 2000 Hz) according to DIN EN 60068-2-6
Shock	100 g / 11 msec according to DIN EN 60068-2-27

Materials	
Pressure port	stainless steel 1.4404 (316 L)
Housing	stainless steel 1.4404 (316 L)
Option compact field housing	stainless steel 1.4305 (303), cable gland brass, nickel plated others on request
Seals (media wetted)	standard: FKM options: EPDM (for $P_N \leq 160$ bar) NBR others on request
Diaphragm	stainless steel 1.4435 (316 L)
Media wetted parts	pressure port, seals, diaphragm

Explosion protection (only for 4 ... 20 mA / 2-wire)	
Approvals DX19-DMP 333	<b>IBExU 10 ATEX 1068 X / IECEx IBE 12.0027X</b> zone 0: II 1G Ex ia IIC T4 Ga zone 20: II 1D Ex ia IIIC T 85°C Da
Safety technical maximum values	$U_i = 28 V_{DC}$ , $I_i = 93 \text{ mA}$ , $P_i = 660 \text{ mW}$ , $C_i \approx 0 \text{ nF}$ , $L_i \approx 0 \mu\text{H}$ , the supply connections have an inner capacity of max. 27 nF to the housing
Permissible temperatures for environment	in zone 0: -20 ... 60 °C with $p_{atm}$ 0.8 bar up to 1.1 bar in zone 1 or higher: -20 ... 70 °C
Connecting cables (by factory)	cable capacitance: signal line/shield also signal line/signal line: 160 pF/m cable inductance: signal line/shield also signal line/signal line: 1 $\mu\text{H}/\text{m}$

Miscellaneous	
Option SIL <sup>3</sup> 2	according to IEC 61508 / IEC 61511
Current consumption	signal output current: max. 25 mA      signal output voltage: max. 7 mA
Weight	approx. 140 g
Installation position	any <sup>4</sup>
Operational life	> 100 x 10 <sup>6</sup> pressure cycles
CE-conformity	EMC Directive: 2004/108/EC      Pressure Equipment Directive: 97/23/EC (module A) <sup>5</sup>
ATEX Directive	94/4/EG

<sup>3</sup> only for 4 ... 20 mA / 2-wire, not in combination with the accuracy 0.1%  
<sup>4</sup> Pressure transmitters are calibrated in a vertical position with the pressure connection down.  
<sup>5</sup> This directive is only valid for devices with maximum permissible overpressure > 200 bar

### Wiring diagrams

2-wire-system (current)

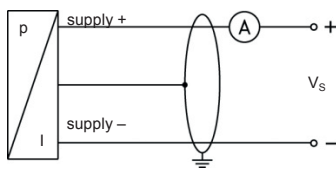

3-wire-system (current / voltage)

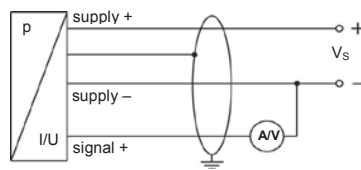

### Pin configuration

Electrical connection	ISO 4400	Binder 723 (5-pin)	M12x1 / metal (4-pin)	field housing	cable colours (DIN 47100)
Supply +	1	3	1	IN +	wh (white)
Supply -	2	4	2	IN -	bn (brown)
Signal + (only for 3-wire)	3	1	3	OUT +	gn (green)
Shield	ground pin	5	4	⏏	ye/gn (yellow / green)

### Electrical connections (dimensions in mm)

standard

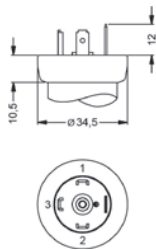

ISO 4400 (IP 65)

option

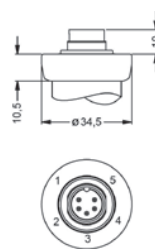

Binder Series 723 5-pin (IP 67)

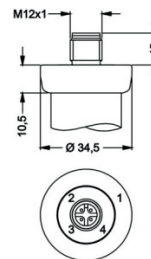

M12x1 4-pin (IP 67)

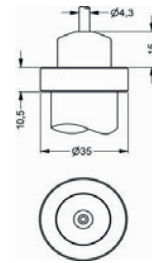

cable outlet with PVC cable (IP 67)<sup>6</sup>

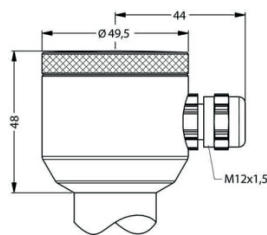

compact field housing (IP 67)

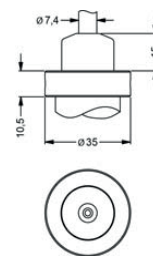

cable outlet, cable with ventilation tube (IP 68)<sup>7</sup>

⇒ universal field housing stainless steel 1.4404 (316 L) with cable gland M20x1.5 (ordering code 880) and other versions on request

<sup>6</sup> standard: 2 m PVC cable without ventilation tube (permissible temperature: -5 ... 70 °C)

<sup>7</sup> different cable types and lengths available, permissible temperature depends on kind of cable

**Mechanical connections (dimensions in mm)**

**standard for accuracy 0.35 / 0.25 %**

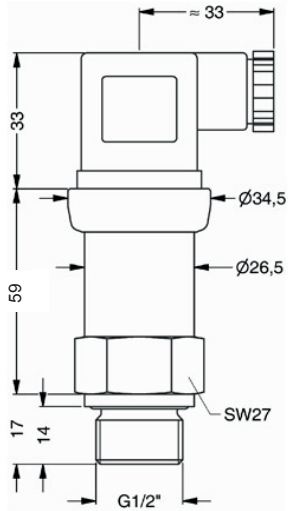

G1/2" DIN 3852  
with ISO 4400

**standard for accuracy 0.1 % ;  
SIL- and SIL-IS-version**

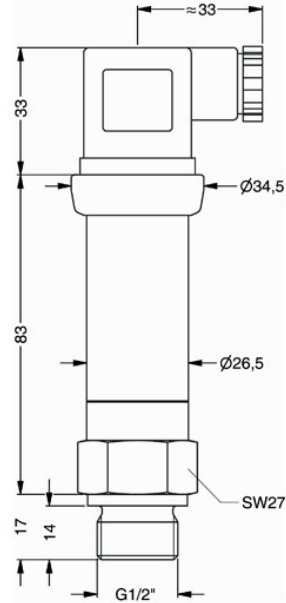

G1/2" DIN 3852  
with ISO 4400

**option**

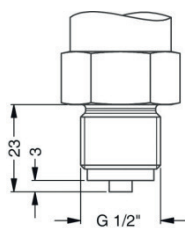

G1/2" EN 837

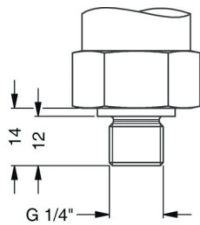

G1/4" DIN 3852

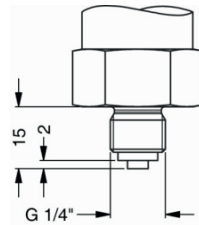

G1/4" EN 837

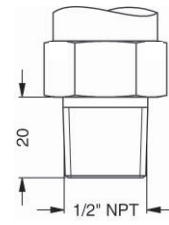

1/2" NPT

⇨ **metric threads and other versions on request**

### DMP 333



<b>Pressure</b>										
	gauge <sup>1</sup>	1	3	0						
	absolute	1	3	1						
<b>Input</b>										
	[bar]									
	60		6	0	0	2				
	100		1	0	0	3				
	160		1	6	0	3				
	250		2	5	0	3				
	400		4	0	0	3				
	600		6	0	0	3				
	customer		9	9	9	9				consult
<b>Output</b>										
	4 ... 20 mA / 2-wire						1			
	0 ... 20 mA / 3-wire						2			
	0 ... 10 V / 3-wire						3			
	Intrinsic safety 4 ... 20 mA / 2-wire						E			
	SIL2 4 ... 20 mA / 2-wire						1S			
	SIL2 with Intrinsic safety									
	4 ... 20 mA / 2-wire						ES			
	customer						9			consult
<b>Accuracy</b>										
	standard	0.35 %					3			
	option 1	0.25 %					2			
	option 2	0.10 % <sup>2</sup>					1			
	customer						9			consult
<b>Electrical connection</b>										
	Male and female plug ISO 4400						1	0	0	
	Male plug Binder series 723 (5-pin)						2	0	0	
	Cable outlet with PVC cable <sup>3</sup>						T	A	0	
	Cable outlet <sup>4</sup>						T	R	0	
	Male plug M12x1 (4-pin) / metal						M	1	0	
	Compact field housing									
	stainless steel 1.4305						8	5	0	
	customer						9	9	9	consult
<b>Mechanical connection</b>										
	G1/2" DIN 3852						1	0	0	
	G1/2" EN 837						2	0	0	
	G1/4" DIN 3852						3	0	0	
	G1/4" EN 837						4	0	0	
	1/2" NPT						N	0	0	
	customer						9	9	9	consult
<b>Seals</b>										
	FKM								1	
	EPDM <sup>5</sup>								3	
	NBR								5	
	customer								9	consult
<b>Special version</b>										
	standard							0	0	0
	customer							9	9	9

<sup>1</sup> measurement starts with ambient pressure

<sup>2</sup> not in combination with SIL

<sup>3</sup> standard: 2 m PVC cable without ventilation tube (permissible temperature: -5 ... 70 °C), optionally without ventilation tube

<sup>4</sup> cable with ventilation tube (code TR0 = PVC cable), different cable types and lengths available, permissible temperature depends on kind of cable, price without cable

<sup>5</sup> possible for nominal pressure ranges  $P_N \leq 160$  bar



# DMP 339

## Industrial Pressure Transmitter

Stainless Steel Sensor

accuracy according to IEC 60770:  
0,35 % FSO

### Nominal pressure

from 0 ... 60 bar to 0 ... 600 bar

### Output signals

2-wire: 4 ... 20 mA

3-wire: 0 ... 20 mA / 0 ... 10 V

others on request

### Special characteristics

- ▶ mechanical connection: G ¼" flush
- ▶ suitable for viscous and pasty media

### Optional versions

- ▶ IS-version  
Ex ia = intrinsically safe for gases and dusts
- ▶ several electrical connections
- ▶ customer specific versions

The DMP 339 industrial pressure transmitter features a G ¼" flush pressure port and was designed for the use in a range of machinery including metering systems. It is ideal for measuring the pressure of viscous and pasty media, as only a small dead space is created.

Material accumulation, dripping and stringing in machinery is eliminated. This increases the efficiency and reliability of your machines.

The DMP 339 is available with various electrical connections, ensuring an excellent adaption to the application conditions.

### Preferred areas of use are:



Plant and Machine Engineering  
- especially conveyor plants and dosing systems



Hydraulics



Input pressure range <sup>1</sup>							
Nominal pressure gauge / abs.	[bar]	60	100	160	250	400	600
Overpressure	[bar]	210	210	600	600	1050	1050
Burst pressure $\geq$	[bar]	300	300	1100	1100	1500	1500

<sup>1</sup> Nominal pressure  $P_N < 60$  bar on request

Output signal / Supply	
Standard	2-wire: 4 ... 20 mA / $V_S = 8 \dots 32 V_{DC}$
Option IS-protection	2-wire: 4 ... 20 mA / $V_S = 10 \dots 28 V_{DC}$
Options 3-wire	3-wire: 0 ... 20 mA / $V_S = 14 \dots 30 V_{DC}$ 0 ... 10 V / $V_S = 14 \dots 30 V_{DC}$
Performance	
Accuracy <sup>2</sup>	$\leq \pm 0.35$ % FSO
Permissible load	current 2-wire: $R_{max} = [(V_S - V_S \text{ min}) / 0.02 \text{ A}] \Omega$ current 3-wire: $R_{max} = 500 \Omega$ voltage 3-wire: $R_{min} = 10 \text{ k}\Omega$
Influence effects	supply: 0.05 % FSO / 10 V load: 0.05 % FSO / $\text{k}\Omega$
Long term stability	$\leq \pm 0.1$ % FSO / year at reference conditions
Response time	2-wire: $\leq 10$ msec 3-wire: $\leq 3$ msec

<sup>2</sup> accuracy according to IEC 60770 – limit point adjustment (non-linearity, hysteresis, repeatability)

Thermal effects (Offset and Span)	
Tolerance band	$\leq \pm 1$ % FSO
in compensated range	-20 ... 85 °C

Permissible temperatures	
Permissible temperatures	medium: -40 ... 125 °C electronics / environment: -40 ... 85 °C storage: -40 ... 100 °C

Electrical protection	
Short-circuit protection	permanent
Reverse polarity protection	no damage, but also no function
Electromagnetic compatibility	emission and immunity according to EN 61326

Mechanical stability	
Vibration	10 g RMS (25 ... 2000 Hz) according to DIN EN 60068-2-6
Shock	100 g / 11 msec according to DIN EN 60068-2-27

Materials	
Pressure port	stainless steel 1.4548 (17-4 PH ERS) for G1/4" flush (DIN 3852)
Housing	stainless steel 1.4404 (316 L)
Option compact field housing	stainless steel 1.4305 (303), cable gland brass, nickel plated others on request
Seals	FKM others on request
Diaphragm	stainless steel 1.4435 (316 L)
Media wetted parts	pressure port, diaphragm

Explosion protection (only for 4 ... 20 mA / 2-wire)	
Approvals DX19-DMP 339	<b>IBExU 10 ATEX 1068 X / IECEx IBE 12.0027X</b> zone 0: II 1G Ex ia IIC T4 Ga zone 20: II 1D Ex ia IIIC T 85°C Da
Safety technical maximum values	$U_i = 28 V_{DC}$ , $I_i = 93 \text{ mA}$ , $P_i = 660 \text{ mW}$ , $C_i \approx 0 \text{ nF}$ , $L_i \approx 0 \mu\text{H}$ , $C_{iGND} \approx 27 \text{ nF}$
Permissible temperatures for environment	-20 ... 70 °C
Connecting cables (by factory)	cable capacitance: signal line/shield also signal line/signal line: 160 pF/m cable inductance: signal line/shield also signal line/signal line: 1 $\mu\text{H}/\text{m}$

Miscellaneous	
Current consumption	signal output current: max. 25 mA      signal output voltage: max. 7 mA
Weight	approx. 120 g
Installation position	any <sup>3</sup>
Operational life	$> 100 \times 10^6$ pressure cycles
CE-conformity	EMC Directive: 2004/108/EC      Pressure Equipment Directive: 97/23/EC (module A) <sup>4</sup>
ATEX Directive	94/4/EG

<sup>3</sup> Pressure transmitters are calibrated in a vertical position with the pressure connection down.

<sup>4</sup> This directive is only valid for devices with maximum permissible overpressure  $> 200$  bar

**Wiring diagrams**

2-wire-system (current)

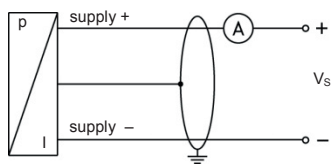

3-wire-system (current / voltage)

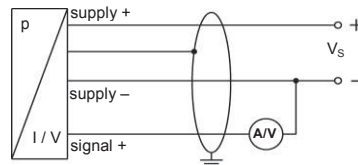
**Pin configuration**

Electrical connection	ISO 4400	Binder 723 (5-pin)	M12x1 / Metal (4-pin)	field housing	cable colours (DIN 47100)
Supply +	1	3	1	IN +	wh (white)
Supply -	2	4	2	IN -	bn (brown)
Signal + (for 3-wire)	3	1	3	OUT +	gn (green)
Shield	ground pin	5	4		ye/gn (yellow / green)

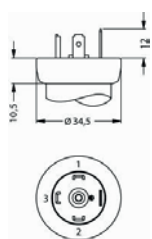
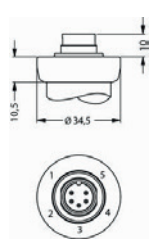
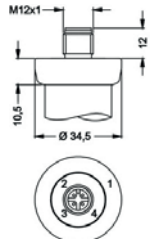
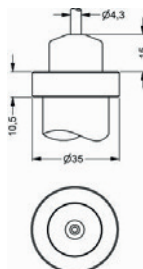
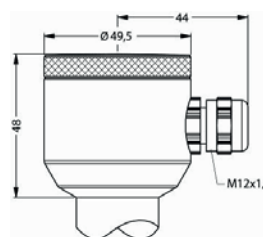
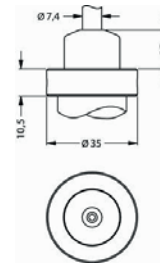
**Electrical connections (dimensions in mm)****standard****option**ISO 4400  
(IP 65)Binder Series 723  
5-pin (IP 67)M12x1  
4-pin (IP 67)cable outlet  
with PVC cable (IP 67)<sup>5</sup>compact field housing  
(IP 67)cable outlet,  
cable with ventilation  
tube (IP 68)<sup>6</sup>

⇒ universal field housing stainless steel 1.4404 (316 L) with cable gland M20x1.5 metal (ordering code 880) and other versions on request

<sup>5</sup> standard: 2 m PVC cable without ventilation tube (permissible temperature: -5 ... 70 °C)

<sup>6</sup> different cable types and lengths available, permissible temperature depends on kind of cable

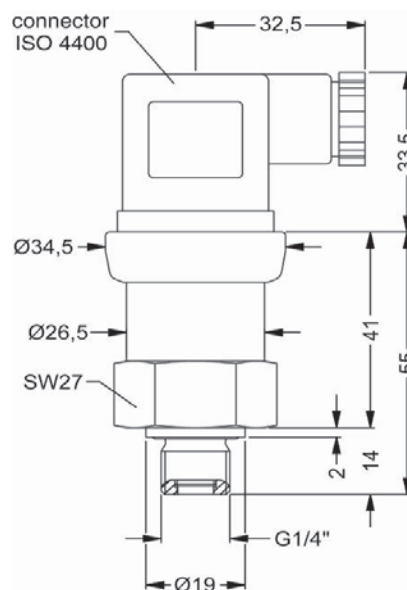
**Mechanical connections (dimensions in mm)**

G1/4" flush DIN 3852



### DMP 339



<b>Pressure</b>											
gauge	1	3	5								
absolute	1	3	6								
<b>Input</b>											
[bar]	1										
60				6	0	0	2				
100				1	0	0	3				
160				1	6	0	3				
250				2	5	0	3				
400				4	0	0	3				
600				6	0	0	3				
customer				9	9	9	9			consult	
<b>Output</b>											
4 ... 20 mA / 2-wire								1			
0 ... 20 mA / 3-wire								2			
0 ... 10 V / 3-wire								3			
Intrinsic safety 4 ... 20 mA / 2-wire								E			
customer								9		consult	
<b>Accuracy</b>											
0.35 %								3			
customer								9		consult	
<b>Electrical connection</b>											
Male and female plug ISO 4400								1	0	0	
Male plug Binder series 723 (5-pin)								2	0	0	
Cable outlet with PVC cable								T	A	0	
Cable outlet								T	R	0	
Male plug M12x1 (4-pin) / metal								M	1	0	
Compact field housing								8	5	0	
stainless steel 1.4305 (303)											
customer								9	9	9	
<b>Mechanical connection</b>											
G1/4" DIN 3852									F	0	2
with flush sensor											
customer								9	9	9	
<b>Seals</b>											
FKM										1	
customer										9	
<b>Special version</b>											
standard									0	0	0
customer									9	9	9
											consult

<sup>1</sup> nominal pressure gauge P<sub>N</sub> < 60 bar on request  
<sup>2</sup> standard: 2 m PVC cable without ventilation tube (permissible temperature: -5 ... 70°C), others on request  
<sup>3</sup> cable with ventilation tube (code TR0 = PVC cable), different cable types and lengths available, price without cable



# DMP 335

## Industrial Pressure Transmitter

Welded, Dry  
Stainless Steel Sensor

accuracy according to IEC 60770:  
0.5 % FSO

### Nominal pressure

from 0 ... 6 bar up to 0 ... 600 bar

### Output signals

2-wire: 4 ... 20 mA  
3-wire: 0 ... 10 V  
others on request

### Special characteristics

- ▶ suitable for oxygen applications
- ▶ insensitive to pressure peaks
- ▶ high overpressure capability





### Optional versions

- ▶ IS-version  
Ex ia = intrinsically safe for gases and dusts
- ▶ customer specific versions

The industrial pressure transmitter DMP 335 is based on a stainless steel welded pressure sensor without fluid.

This characteristic has a special advantage with applications where silicon oil or elastomeric seals cannot be used.

### Bevorzugte Anwendungsgebiete

-  Medical Technology
-  Plant and Machine Engineering
-  Mobile Hydraulics
-  Refrigeration
-  Oxygen application

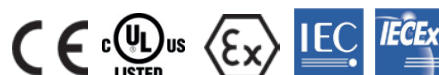

Input pressure range												
Nominal pressure gauge	[bar]	6	10	16	25	40	60	100	160	250	400	600
Overpressure	[bar]	14	35	35	70	140	140	350	350	700	1200	1200
Burst pressure $\geq$	[bar]	35	85	85	175	350	350	850	850	1750	2100	2100
Vacuum resistance		unlimited										
Output signal / Supply												
Standard	2-wire:	4 ... 20 mA / $V_S = 8 \dots 32 V_{DC}$										
Option IS-version	2-wire:	4 ... 20 mA / $V_S = 10 \dots 28 V_{DC}$										
Option 3-wire	3-wire:	0 ... 10 V / $V_S = 14 \dots 30 V_{DC}$										
Performance												
Accuracy <sup>1</sup>		$\leq \pm 0.5 \% \text{ FSO}$										
Permissible load		current 2-wire: $R_{\max} = [(V_S - V_{S \min}) / 0.02 \text{ A}] \Omega$ voltage 3-wire: $R_{\min} = 10 \text{ k}\Omega$										
Influence effects		supply: 0.05 % FSO / 10 V load: 0.05 % FSO / $\text{k}\Omega$										
Long term stability		$\leq \pm 0.2 \% \text{ FSO} / \text{year}$ at reference conditions										
Response time		2-wire: $\leq 10 \text{ msec}$ 3-wire: $\leq 3 \text{ msec}$										
<sup>1</sup> accuracy according to IEC 60770 – limit point adjustment (non-linearity, hysteresis, repeatability)												
Thermal effects (Offset and Span)												
Thermal error		$\pm 0.3 \% \text{ FSO} / 10 \text{ K}$										
in compensated range		0 ... 70 °C										
Permissible temperatures												
Permissible temperatures		medium: -40 ... 125 °C electronics / environment: -40 ... 85 °C storage: -40 ... 100 °C										
Electrical protection												
Short-circuit protection		permanent										
Reverse polarity protection		no damage, but also no function										
Electromagnetic compatibility		emission and immunity according to EN 61326										
Mechanical stability												
Vibration		20 g RMS (25 ... 2000 Hz) according to DIN EN 60068-2-6										
Shock		500 g / 1 msec according to DIN EN 60068-2-27										
Materials												
Pressure port		stainless steel 1.4571 (316 Ti)										
Housing		stainless steel 1.4404 (316 L)										
Option compact field housing		stainless steel 1.4305 (303), cable gland brass, nickel plated others on request										
Seals (media wetted)		none (welded)										
Diaphragm		stainless steel 1.4542 (17-4PH)										
Media wetted parts		pressure port, diaphragm										
Explosion protection (only for 4 ... 20 mA / 2-wire)												
Approvals DX19-DMP 335		IBExU 10 ATEX 1068 X / IECEx IBE 12.0027X zone 0: II 1G Ex ia IIC T4 Ga zone 20: II 1D Ex ia IIIC T 85°C Da										
Safety technical maximum values		$U_i = 28 V_{DC}$ , $I_i = 93 \text{ mA}$ , $P_i = 660 \text{ mW}$ , $C_i \approx 0 \text{ nF}$ , $L_i \approx 0 \mu\text{H}$ , the supply connections have an inner capacity of max. 27 nF to the housing										
Permissible temperatures for environment		in zone 0: -20 ... 60 °C bei $p_{\text{atm}}$ 0.8 bar up to 1.1 bar in zone 1: -20 ... 70 °C										
Connecting cables (by factory)		cable capacitance: signal line/shield also signal line/signal line: 160 pF/m cable inductance: signal line/shield also signal line/signal line: 1 $\mu\text{H}/\text{m}$										
Miscellaneous												
Current consumption		signal output current: max. 25 mA signal output voltage: max. 7 mA										
Weight		approx. 140 g										
Installation position		any										
Operational life		$> 100 \times 10^5$ pressure cycles										
CE-conformity		EMC Directive: 2004/108/EC Pressure Equipment Directive: 97/23/EC (module A) <sup>2</sup>										
ATEX Directive		94/4/EG										
<sup>2</sup> This directive is only valid for devices with maximum permissible overpressure > 200 bar												

## Wiring diagrams

2-wire-system (current)

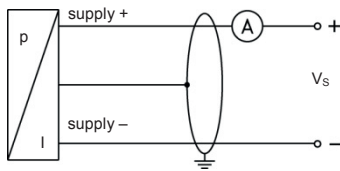

3-wire-system (voltage)

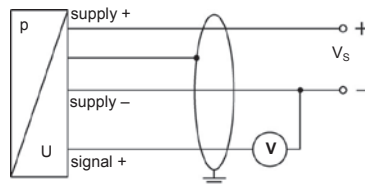

## Pin configuration

Electrical connections	ISO 4400	Binder 723 (5-pin)	M12x1 (4-pin)	field housing	cable colours (DIN 47100)
Supply +	1	3	1	IN +	wh (white)
Supply -	2	4	2	IN -	bn (brown)
Signal + (only for 3-wire)	3	1	3	OUT +	gn (green)
Shield	ground pin	5	4	⊥	ye/gn (yellow / green)

## Electrical connections (dimensions in mm)

standard

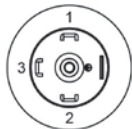
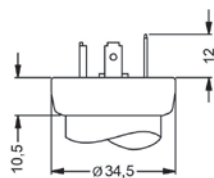
ISO 4400  
(IP 65)

option

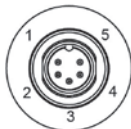
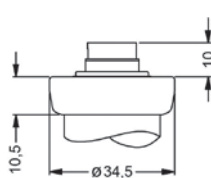
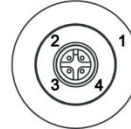
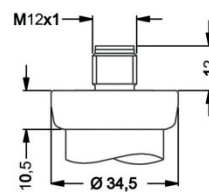
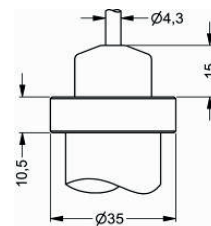
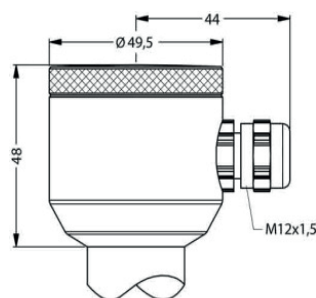
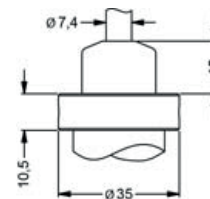
Binder series 723 5-pin  
(IP 67)M12x1 4-pin  
(IP 67)cable outlet with PVC cable  
(IP67)<sup>3</sup>compact field housing  
(IP 67)cable outlet,  
cable with ventilation tube  
(IP 68)<sup>4</sup>

⇒ universal field housing stainless steel 1.4404 (316 L) with cable gland M20x1.5 (ordering code 880) and other versions on request

<sup>3</sup> standard: 2 m PVC cable without ventilation tube (permissible temperature: -5 ... 70 °C)

<sup>4</sup> different cable types and lengths available, permissible temperature depends on kind of cable

### Mechanical connections (dimensions in mm)

**standard**

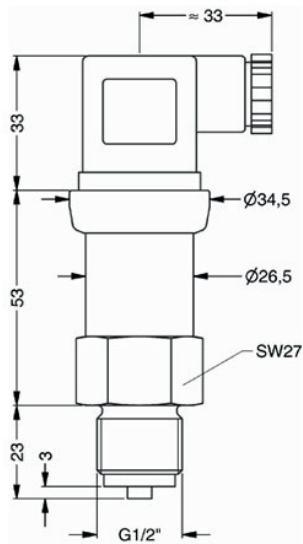

G1/2" EN 837

**option**

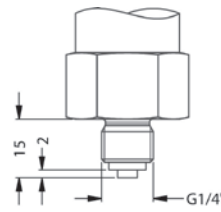

G1/4" EN 837

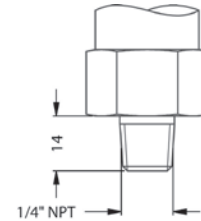

1/4" NPT

⇒ metric threads and other versions on request





# DMP 334

## Industrial Pressure Transmitter for High Pressure

Thinfilm Sensor

accuracy according to IEC 60770:  
0.35 % FSO

### Nominal pressure

from 0 ... 600 bar up to 0 ... 2200 bar

### Analogue output

2-wire: 4 ... 20 mA

3-wire: 0 ... 10 V

others on request

### Special characteristics

- ▶ extremely robust and excellent long-term stability
- ▶ pressure sensor welded

### Optional versions

- ▶ IS-version  
Ex ia = intrinsically safe for gases and dusts
- ▶ pressure port: M20 x 1.5 or 9/16 UNF
- ▶ adjustability of span and offset
- ▶ different kinds of electrical connections

The industrial pressure transmitter DMP 334 has been especially designed for use in hydraulic systems up to 2200 bar. The base element of DMP 334 is a thinfilm sensor, that is welded with the pressure port and meets high demands of accuracy and reliability.

All of characteristics and the excellent measurement data of DMP 334 as well as distinguished offset stability offer a pressure transmitter with easy handling, reliability and robustness for hydraulic user. The DMP 334 is deliverable with standard HP connections.

### Preferred areas of use are



Plant and Machine Engineering



Commercial Vehicles and Mobile Hydraulics



Input pressure range						
Nominal pressure gauge	[bar]	600 <sup>1</sup>	1000	1600	2000	2200
Overpressure	[bar]	800	1400	2200	2800	2800
<sup>1</sup> only available with pressure port G1/2" EN 837						
Output signal / Supply						
Standard	2-wire:	4 ... 20 mA / V <sub>S</sub> = 12 ... 36 V <sub>DC</sub>				
Option IS-protection	2-wire:	4 ... 20 mA / V <sub>S</sub> = 14 ... 28 V <sub>DC</sub>				
Option 3-wire	3-wire:	0 ... 10 V / V <sub>S</sub> = 14 ... 36 V <sub>DC</sub>				
Performance						
Accuracy	≤ ± 0.35 % FSO IEC 60770 <sup>2</sup>					
Permissible load	current 2-wire:	R <sub>max</sub> = [(V <sub>S</sub> - V <sub>S</sub> min) / 0.02 A] Ω				
	voltage 3-wire:	R <sub>min</sub> = 10 kΩ				
Influence effects	supply:	0.05 % FSO / 10 V			load: 0.05 % FSO / kΩ	
Long term stability	≤ ± 0.2 % FSO / year					
Response time	< 5 msec					
Adjustability	Adjustment of offset is possible within the range of ± 5 % of the nominal pressure range, without an influence of characteristic curve and accuracy.					
<sup>2</sup> accuracy according to IEC 60770 – limit point adjustment (non-linearity, hysteresis, repeatability)						
Thermal effects (Offset and Span) / Permissible temperatures						
Thermal error	≤ ± 0.25 % FSO / 10 K		in compensated range -20 ... 85 °C			
Permissible temperatures	medium:	-40 ... 140 °C	electronics / environment:	-25 ... 85 °C		storage: -40 ... 100 °C
Electrical protection						
Short-circuit protection	permanent					
Reverse polarity protection	no damage, but also no function					
Electromagnetic compatibility	emission and immunity according to EN 61326					
Mechanical stability						
Vibration	10 g RMS (20 ... 2000 Hz)					
Shock	100 g / 11 msec.					
Materials						
Pressure port	stainless steel 1.4542 (17-4 PH)					
Housing	standard:	stainless steel 1.4404 (316L)				
	field housing:	stainless steel 1.4404 (316L), cable gland: brass, nickel plated				
Seals (media wetted)	none (welded version)					
Diaphragm	stainless steel 1.4542 (17-4 PH)					
Media wetted parts	pressure port / diaphragm					
Explosion protection (only for 4 ... 20 mA / 2-wire)						
Approval DX13-DMP 334	TÜV 03 ATEX 2006 X zone 0: II 1G EEx ia IIC T4 zone 20: II 1D EEx tD A20 IP65 T 85°C					
Safety technical maximum values	U <sub>i</sub> = 28 V, I <sub>i</sub> = 93 mA, P <sub>i</sub> = 660 mW, C <sub>i</sub> ≤ 1nF, L <sub>i</sub> ≤ 10 μH					
Permissible temperatures for environment	in zone 0:	-20 ... 60 °C with p <sub>atm</sub> 0.8 bar up to 1.1 bar				
	in zone 1 or higher:	-25 ... 70 °C				
Connecting cables (by factory)	cable capacitance: signal line/shield also signal line/signal line: 160 pF/m cable inductance: signal line/shield also signal line/signal line: 1 μH/m					
Miscellaneous						
Current consumption	signal output current:	max. 25 mA				
	signal output voltage:	max. 7 mA				
Weight	approx. 200 g					
Installation position	any					
CE-conformity	EMC Directive: 2004/108/EC			Pressure Equipment Directive: 97/23/EC (module A)		
Wiring diagrams						
2-wire-system (current)			3-wire-system (current / voltage)			



Pin configuration					
Electrical connection	ISO 4400	Binder 723 (5-pin)	M12x1 (4-pin)	Field housing	Cable colours (DIN 47100)
Supply +	1	3	1	IN +	wh (white)
Supply -	2	4	2	IN -	bn (brown)
Signal + (only for 3-wire)	3	1	3	OUT+	gn (green)
Shield	ground pin	5	4	⊥	ye/gn (yellow / green)

**Electrical connections (dimensions in mm)**

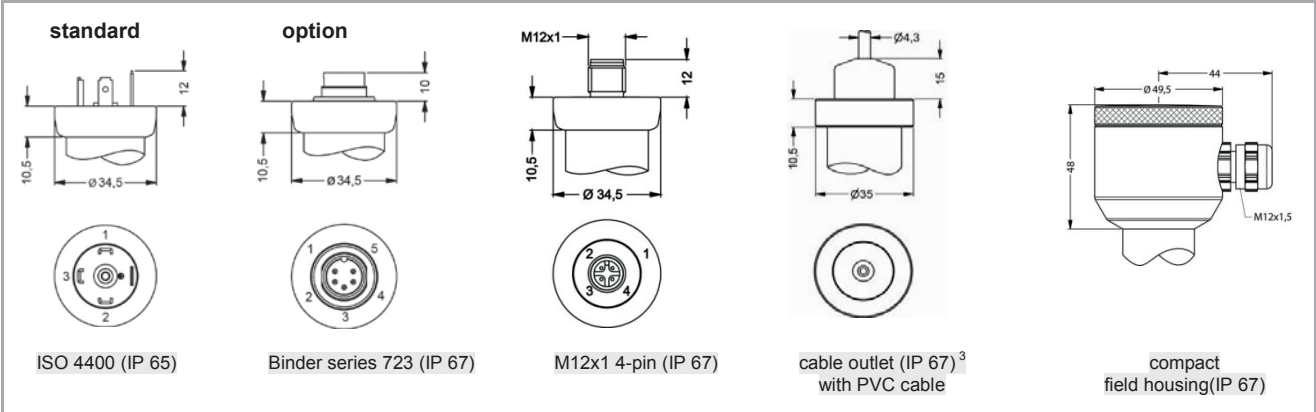

<sup>3</sup> standard: 2 m PVC cable without ventilation tube (permissible temperature: -5 ... 70 °C)

**Mechanical connection (dimensions in mm)**

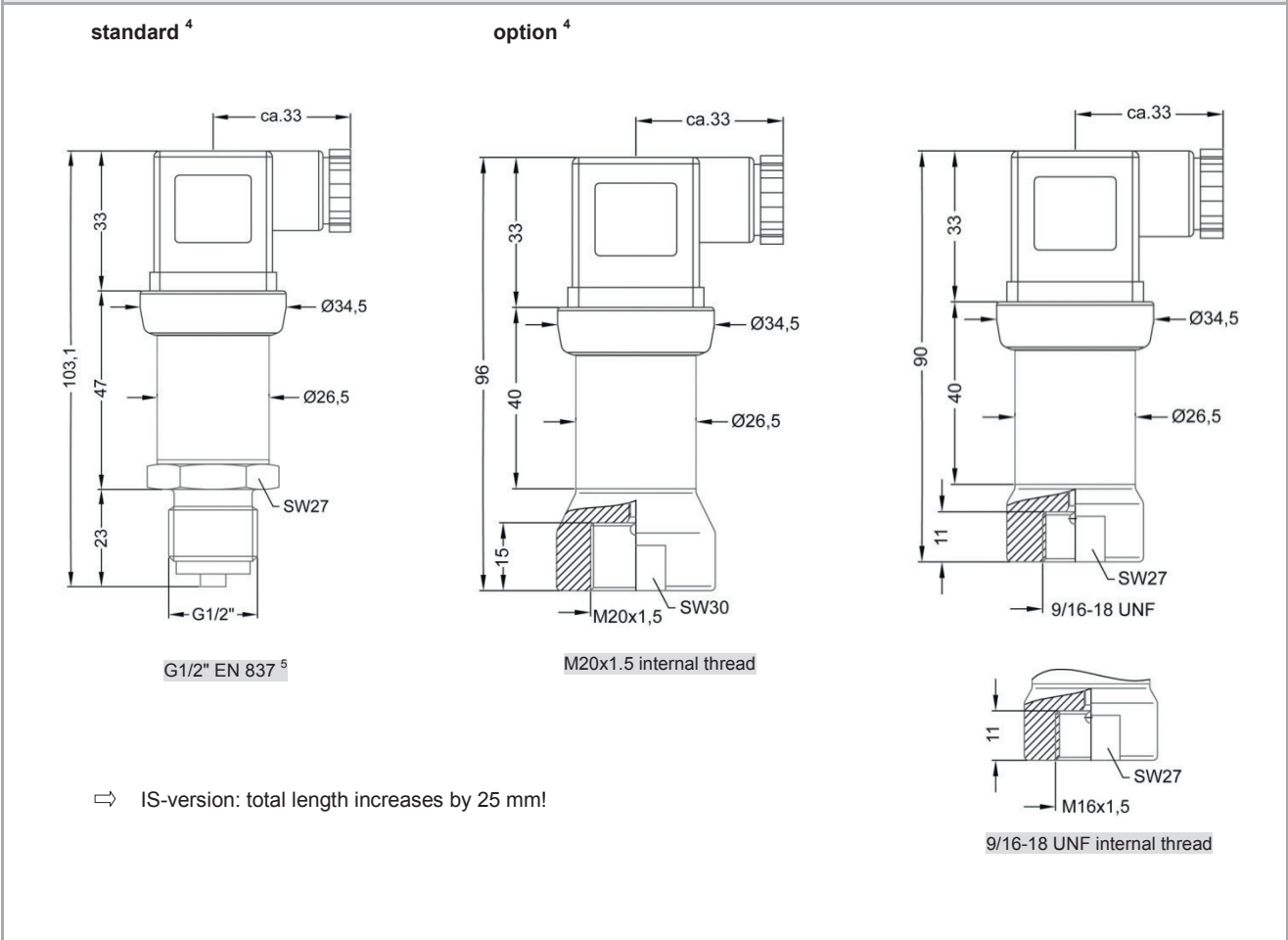

<sup>4</sup> adjustable version is not possible in combination with IS-version, compact field housing and cable outlet  
<sup>5</sup> According to EN 837, the pressure port and the complement at pressure over 1000 bar must be preferably made of stainless steel with a tensile strength of  $R_p > 260 \text{ N/mm}^2$  in accordance with DIN 17440. The maximum allowed pressure is 1600 bar!

### DMP 334



<b>Pressure</b>												
	gauge	1	4	0								
<b>Input</b>												
	[bar]											
	600 <sup>1</sup>	6	0	0	3							
	1000	1	0	0	4							
	1600	1	6	0	4							
	2000	2	0	0	4							
	2200	2	2	0	4							
	customer	9	9	9	9						consult	
<b>Output</b>												
	4 ... 20 mA / 2-wire									1		
	0 ... 10 V / 3-wire									3		
	Intrinsic safety 4 ... 20 mA / 2-wire									E		
	customer									9	consult	
<b>Accuracy</b>												
	0.35 %									3		
	customer									9	consult	
<b>Electrical connection</b>												
	Male and female plug ISO 4400									1	0	0
	Male plug Binder series 723 (5-pin)									2	0	0
	Cable outlet with PVC cable <sup>2,3</sup>									T	A	0
	Male plug M12x1 (4-pin) / metal									M	1	0
	Compact field housing									8	5	0
	stainless steel 1.4404 (316L)											
	customer									9	9	9
												consult
<b>Mechanical connection</b>												
	G1/2" EN 837 <sup>4</sup>									2	0	0
	M20x1.5 internal thread									D	2	8
	9/16 UNF internal thread									V	0	0
	customer									9	9	9
												consult
<b>Seals</b>												
	without (welded version)									2		
	customer									9		consult
<b>Special version</b>												
	standard (adjustable) <sup>5</sup>									0	4	1
	only for IS version									0	0	0
	customer									9	9	9
												consult

<sup>1</sup> only available with pressure port G1/2" EN 837  
<sup>2</sup> different cable types and lengths deliverable  
<sup>3</sup> standard: 2 m PVC cable without ventilation tube (permissible temperature: -5 ... 70 °C), optionally cable with ventilation tube  
<sup>4</sup> According to EN 837, the pressure port and the complement, at pressure over 1000 bar must be preferably made of stainless steel with a tensile strength of R<sub>p</sub> > 260 N/mm<sup>2</sup> in accordance with DIN 17440. The maximum allowed pressure is 1600 bar!  
<sup>5</sup> not possible in combination with IS-version, compact field housing and cable outlet with PVC cable



# DMP 304

## Industrial Pressure Transmitter for Ultra High Pressure

accuracy according to IEC 60770:  
standard: 0.5 % FSO  
option: 0.25 % FSO

### Nominal pressure

from 0 ... 2 000 bar up to 0 ... 6 000 bar

### Output signals

2-wire: 4 ... 20 mA

3-wire: 0 ... 10 V (on request)

### Special characteristics

- ▶ adjustability of offset and span via front sided potentiometers
- ▶ pressure port 9/16" UNF
- ▶ 80 % calibration signal with MIL / Bendix plug

### Optional versions

- ▶ IS-version:  
Ex ia = intrinsically safe for gases
- ▶ accuracy according to IEC 60770:  
0.25 % FSO
- ▶ pressure port M20x1.5 and M16x1.5

The ultra-high-pressure transmitter type DMP 304 has been especially designed for applications with highest demand on precision and reliability. DMP 304 series is based on a compensated strain gauge, bonded onto a stainless steel diaphragm.

Due to the rugged stainless steel housing usage under extreme conditions and in IS-required areas is no problem.

### Preferred areas of use are



hydraulic circuits



water jet torching



high pressure applications in chemical and petrochemical industry



Input pressure range					
Nominal pressure gauge	[bar]	2 000	4 000	5 000	6 000
Overpressure	[bar]	3 000	5 000	6 000	7 000
Burst pressure	[bar]	4 000	8 000	10 000	10 000
Output signal / Supply					
Standard	2-wire:	4 ... 20 mA / $V_S = 10 \dots 30 V_{DC}$			
IS-protection	2-wire:	4 ... 20 mA / $V_S = 10 \dots 28 V_{DC}$			
Option 3-wire (on request)	3-wire:	0 ... 10 V / $V_S = 14 \dots 36 V_{DC}$			
Performance					
Accuracy <sup>1</sup>	standard:	$\leq \pm 0.50 \% \text{ FSO}$			
	option:	$\leq \pm 0.25 \% \text{ FSO (on request)}$			
Permissible load	current 2-wire:	$R_{\max} = [(V_S - V_{S \min}) / 0.02 \text{ A}] \Omega$			
	voltage 3-wire:	$R_{\min} = 10 \text{ k}\Omega$			
Influence effects	supply	0.05 % FSO / 10 V			
	load:	0.05 % FSO / $\text{k}\Omega$			
Long term stability		$\leq \pm 0.2 \% \text{ FSO / year}$			
Response time		< 2.5 msec			
Adjustability		Via a front sided potentiometer is an adjustment of the offset possible within the range of $\pm 5 \%$ of the nominal pressure range, without an influence of characteristic curve and accuracy.			
<sup>1</sup> accuracy according to IEC 60770 – limit point adjustment (non-linearity, hysteresis, repeatability)					
Calibration (only with MIL / Bendix plug)					
Calibration signal accuracy		$\leq \pm 0.25 \% \text{ FSO}$			
Calibration		80 % FSO calibration (e.g. for 4 ... 20 mA / 2-wire: signal = $0.8 \cdot 16 \text{ mA} + 4 \text{ mA} = 16.8 \text{ mA}$ )			
Thermal effects (Offset and Span)					
Thermal error		$\leq \pm 0.2 \% \text{ FSO / 10 K}$ in compensated range -20 ... 85 °C			
Permissible temperatures					
Permissible temperatures	medium:	-40 ... 85 °C			
	electronics / environment:	-25 ... 85 °C			
	storage:	-40 ... 85 °C			
Electrical protection					
Short-circuit protection		permanent			
Reverse polarity protection		no damage, but also no function			
Electromagnetic compatibility		emission and immunity according to EN 61326			
Mechanical stability					
Vibration		10 g RMS (20 ... 2000 Hz)			
Shock		100 g / 11 msec			
Materials					
Pressure port / diaphragm		stainless steel 1.4548 (17-4 PH)			
Housing		standard: stainless steel 1.4301 (304)			
Seals (media wetted)		none (welded version)			
Media wetted parts		pressure port, diaphragm			
IS-protection (only for 4 ... 20 mA / 2-wire)					
Approval DX17-DMP 304		zone 0: II 1G Ex ia IIC T4			
Safety technical maximum values		$U_i = 28 \text{ V}$ , $I_i = 93 \text{ mA}$ , $P_i = 660 \text{ mW}$			
Permissible temperatures for environment		in zone 0: -20 ... 60 °C with $p_{\text{atm}}$ 0.8 bar up to 1.1 bar zone 1 and higher: -25 ... 70 °C			
Connecting cables (by factory)	cable capacity:	signal line/shield as well as signal line/signal line: 160 pF/m			
	cable inductance:	signal line/shield as well as signal line/signal line: 1 $\mu\text{H}/\text{m}$			
Miscellaneous					
Insulation strength / resistance	standard:	insulation strength	100 M $\Omega$ @ 35 V		
	IS-version:	insulation resistance	100 M $\Omega$ @ 35 V <sub>DC</sub> 100 M $\Omega$ @ 500 V <sub>AC</sub> (relative to housing)		
Current consumption	2-wire signal output current:	max. 28 mA			
	3-wire signal output voltage:	max. 15 mA			
Weight		approx. 260 g			
Installation position		any			
CE-conformity	EMC Directive:	2004/108/EC		Pressure Equipment Directive: 97/23/EC (module A)	

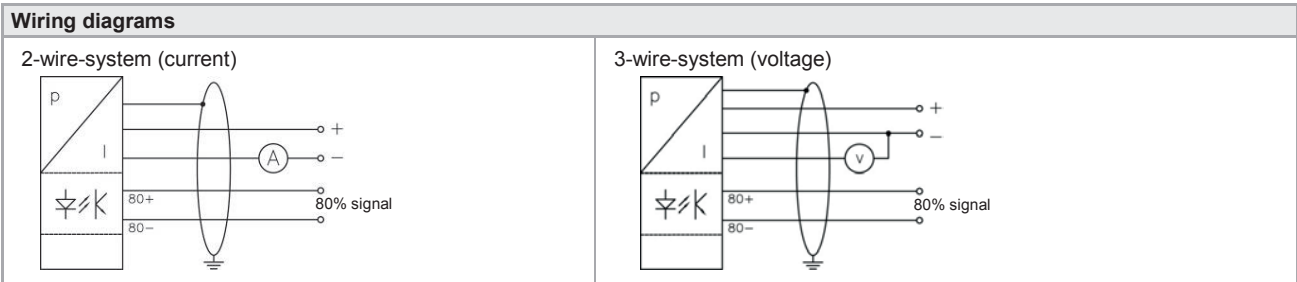

**Pin configuration**

Electrical connections	Binder 723 (5-pin)	M12x1 (4-pin)	ISO 4400	cable colours (DIN 47100)
Supply +	3	1	1	wh (white)
Supply -	4	2	2	bn (brown)
Signal + (only for 3-wire)	1	3	3	gn (green)
Shield	5	4	pin	gn/ye (green / yellow)

**Pin configuration MIL / Bendix plug (optional)**

Version	Pin A	Pin B	Pin C	Pin D	Pin E	Pin F
2-wire current signal 4 ... 20 mA	supply +/- signal +	supply - / signal -	-	-	calibration +	calibration -
3-wire	signal +	supply - / signal - / calibration -	supply +	-	-	calibration +

**Electrical connections (dimensions in mm)**

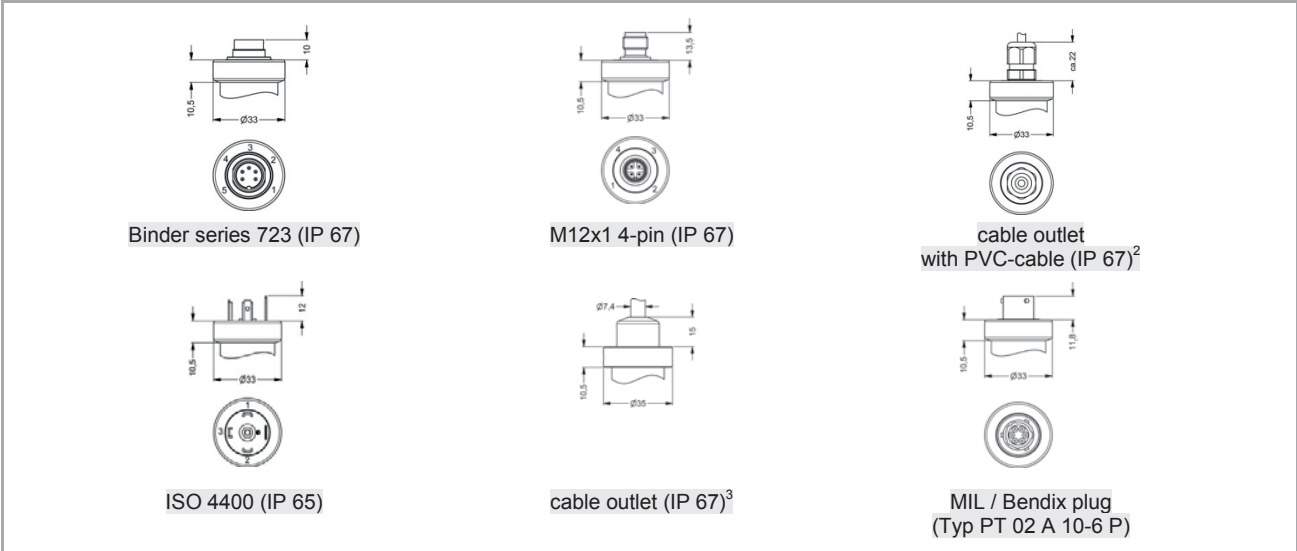

<sup>2</sup> standard: 2 m PVC-cable without air tube (permissible temperature: -5 ... 70 °C)  
<sup>3</sup> different cable types and lengths available, permissible temperature depends on kind of cable

**Mechanical connections (dimensions in mm)**

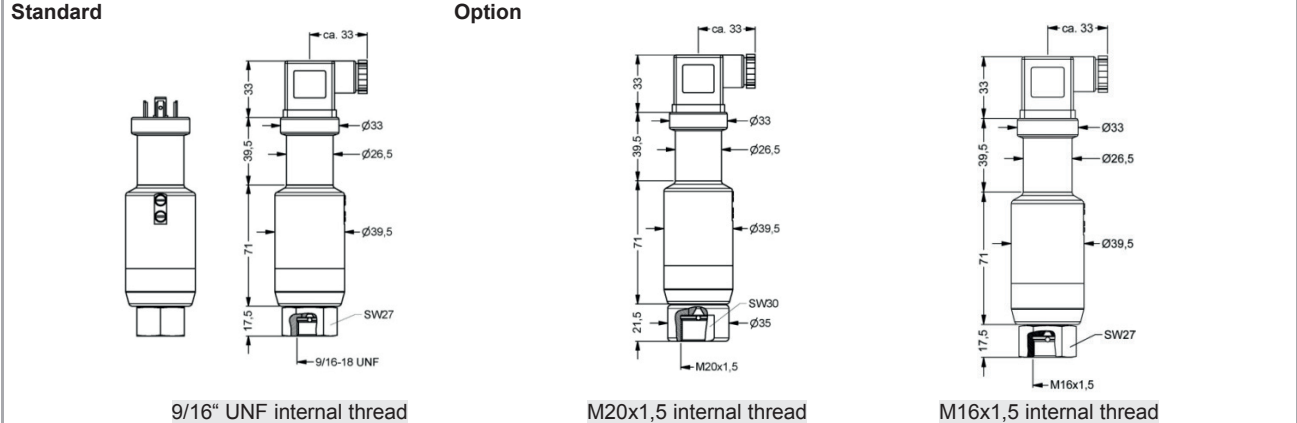

This document contains product specifications; properties are not guaranteed. Subject to change without notice.

## DMP 304



<b>Pressure</b>										
	gauge	2	2	0						
<b>Input</b>										
	[bar]									
	2 000		2	0	0	4				
	4 000		4	0	0	4				
	5 000		5	0	0	4				
	6 000		6	0	0	4				
	customer		9	9	9	9				consult
<b>Output</b>										
	4 ... 20 mA / 2-wire								1	
	Intrinsic safety 4 ... 20 mA / 2-wire								E	
	0 ... 10 V / 3-wire								3	consult
	customer								9	consult
<b>Accuracy</b>										
	standard	0.5 %							5	
	option	0.25 %							2	consult
	customer								9	consult
<b>Electrical connection</b>										
	Male and female plug ISO 4400								1	0 0
	Male plug Binder series 723 (5-pin)								2	0 0
	Cable outlet with PVC-cable <sup>1</sup>								T	A 0
	Cable outlet <sup>2</sup>								T	R 0
	Male plug M12x1 (4-pin), metal								M	1 0
	MIL-/Bendix (Typ PT 02 A 10-6 P)								B	G 0
	customer								9	9 9
<b>Mechanical connection</b>										
	9/16" UNF internal thread								V	0 0
	M16x1.5 internal thread								P	0 0
	M20x1.5 internal thread								D	2 8
	customer								9	9 9
<b>Special version</b>										
	adjustable									0 4 1
	customer									9 9 9

<sup>1</sup> standard: 2 m PVC cable without ventilation tube (permissible temperature: -5 ... 70 °C), optionally cable with ventilation tube

<sup>2</sup> different cable types and lengths deliverable (permissible temperature depends on kind of cable)



# DMK 351

## Pressure Transmitter

Ceramic Sensor

accuracy according to IEC 60770:  
standard: 0.35 % FSO  
option: 0.25 % FSO

### Nominal pressure

from 0 ... 40 mbar up to 0 ... 20 bar

### Output signal

2-wire: 4 ... 20 mA

3-wire: 0 ... 10 V

others on request

### Product characteristics

- ▶ high media resistance

### Optional versions

- ▶ IS-version  
Ex ia = intrinsically safe for gases and dusts
- ▶ diaphragm 99.9 % Al<sub>2</sub>O<sub>3</sub>
- ▶ customer specific versions

The pressure transmitter DMK 351 has been specially designed for applications in plant and machine engineering as well as laboratory techniques and is suitable for measuring small system pressure and filling heights.

By using our own-developed capacitive sensor, optionally available as Al<sub>2</sub>O<sub>3</sub> 99.9%, the DMK 351 offers a high overpressure resistance and a high temperature and media resistance. The pressure transmitter is available in an intrinsically safe version for a use in explosive environments.

### Preferred areas of use are



Plant and Machine Engineering



Laboratory Techniques

### Preferred used for



Fuel and Oil



Water



<b>Pressure ranges</b>																
Nominal pressure	[bar]	0.04	0.06	0.1	0.16	0.25	0.4	0.6	1	1.6	2.5	4	6	10	16	20
Level	[mH <sub>2</sub> O]	0.4	0.6	1	1.6	2.5	4	6	10	16	25	40	60	100	160	200
Overpressure	[bar]	2	2	4	4	6	6	8	8	15	25	25	35	35	45	45
Low pressure	[bar]	-0.2		-0.3		-0.5				-1						
<b>Output signal / Supply</b>																
Standard	2-wire:	4 ... 20 mA / V <sub>S</sub> = 9 ... 32 V <sub>DC</sub>														
Option IS-protection	2-wire :	4 ... 20 mA / V <sub>S</sub> = 14 ... 28 V <sub>DC</sub>														
	Option 3-wire:	0 ... 10 V / V <sub>S</sub> = 12.5 ... 32 V <sub>DC</sub>														
<b>Performance</b>																
Accuracy <sup>1</sup>	standard:	≤ ± 0.35 % FSO														
	option for P <sub>N</sub> ≥ 0.6 bar:	≤ ± 0.25 % FSO														
Permissible load	current 2-wire R <sub>max</sub> = [(V <sub>S</sub> - V <sub>Smin</sub> ) / 0.02 A] Ω	voltage 3-wire: R <sub>min</sub> = 10 k Ω														
Influence effects	supply:	0.05 % FSO / 10 V														
	load:	0.05 % FSO / kΩ														
Long term stability	≤ ± 0.1 % FSO / year															
Turn-on time	700 msec															
Mean measuring rate	5/sec															
Response time	mean response time: < 200 msec									max. response time: 380 msec						
<sup>1</sup> accuracy according to IEC 60770 - limit point adjustment (non-linearity, hysteresis, repeatability)																
<b>Thermal errors (Offset and Span)</b>																
Tolerance band	± ± 0.1 % FSO / 10 K in compensated range: -20 ... 80 °C															
<b>Permissible temperatures</b>																
Permissible temperatures	medium:	-40 ... 125 °C														
	electronics / environment:	-40 ... 85 °C														
	storage:	-40 ... 100 °C														
<b>Electrical protection</b>																
Short-circuit protection	permanent															
Reverse polarity protection	no damage, but also no function															
Electromagnetic compatibility	emission and immunity according to EN 61326															
<b>Mechanical stability</b>																
Vibration	10 g RMS (20 ... 2000 Hz)									according to DIN EN 60068-2-6						
Shock	100 g / 1 msec									according to DIN EN 60068-2-27						
<b>Materials</b>																
Pressure port	stainless steel 1.4404 (316L)															
Housing	stainless steel 1.4404 (316L)															
Option compact field housing	stainless steel 1.4305 (303) with cable gland brass, nickel plated											others on request				
Seal (media wetted)	FKM EPDM															
Diaphragm	standard: ceramics Al <sub>2</sub> O <sub>3</sub> 96 % option: ceramics Al <sub>2</sub> O <sub>3</sub> 99.9 %															
Media wetted parts	pressure port, seals, diaphragm															
<b>IS-protection (only for 4 ... 20 mA / 2-wire)</b>																
Approval DX 14-DMK 351	IBExU 05 ATEX 1070 X Male (connector)-version: zone 0: II 1G Ex ia IIC T4 Ga zone 20: II 1D Ex iaD 20 T 85°C cable-version: zone 0: II 1G Ex ia IIB T4 Ga zone 20: II 1D Ex iaD 20 T 85°C															
Safety technical maximum values	U <sub>i</sub> = 28 V <sub>DC</sub> , I <sub>i</sub> = 93 mA, P <sub>i</sub> = 660 mW, C <sub>i</sub> ≤ 27 nF, L <sub>i</sub> ≤ 5 μH															
Max. permissible temperature for environment	in zone 0: -20 ... 60 °C for p <sub>atm</sub> 0.8 bar up to 1.1 bar in zone 1 and higher: -25 ... 70 °C															
Connecting cables (by factory)	capacity: signal line / shield also signal line / signal line: 160 pF/m inductance: signal line / shield also signal line / signal line: 1 μH/m															
<b>Miscellaneous</b>																
Installation position	any															
Current consumption	signal output current: max. 21 mA									signal output voltage: max. 5 mA						
Weight	min. 200 g															
Operational life	> 100 x 10 <sup>6</sup> loading cycles															
CE-conformity	EMC-directive: 2004/108/EC															
ATEX Directive	94/9/EC															



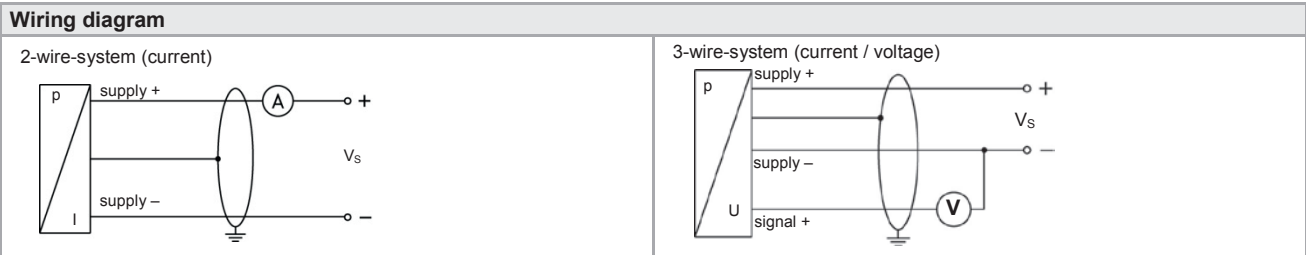

**Pin configuration**

Electrical connection	ISO 4400	Binder 723 (5-pin)	M12x1 (4-pin)	field housing	cable colours (DIN 47100)
Supply +	1	3	1	IN +	wh (white)
Supply -	2	4	2	IN -	bn (brown)
Signal +	3	1	3	OUT +	gn (green)
Shield	ground contact	5	4	⏏	ye/gn (yellow / green)

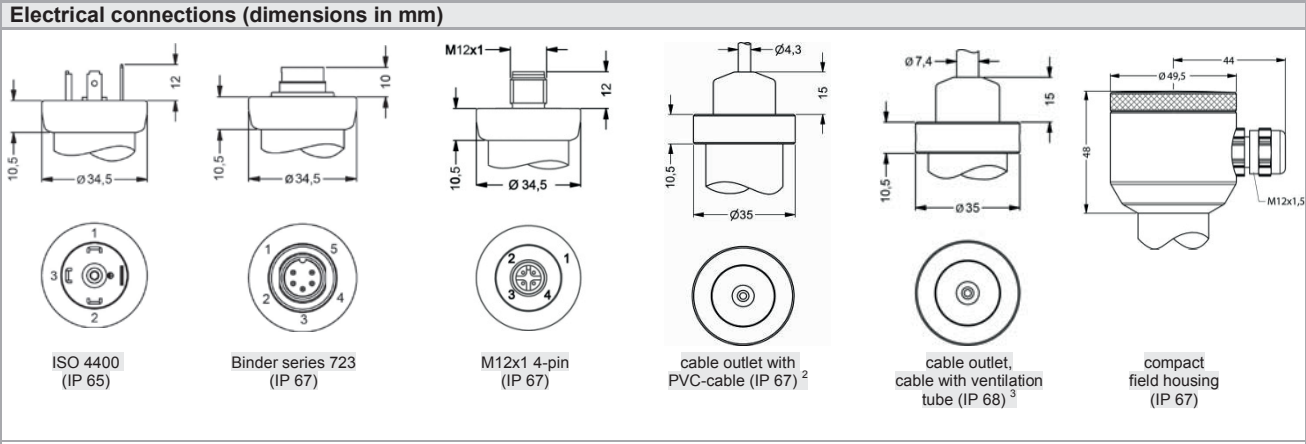

<sup>2</sup> standard: 2 m PVC-cable without ventilation tube (permissible temperature: -5 ... 70°C), optional cable with ventilation tube  
<sup>3</sup> different cable types and lengths available, permissible temperature depends on kind of cable

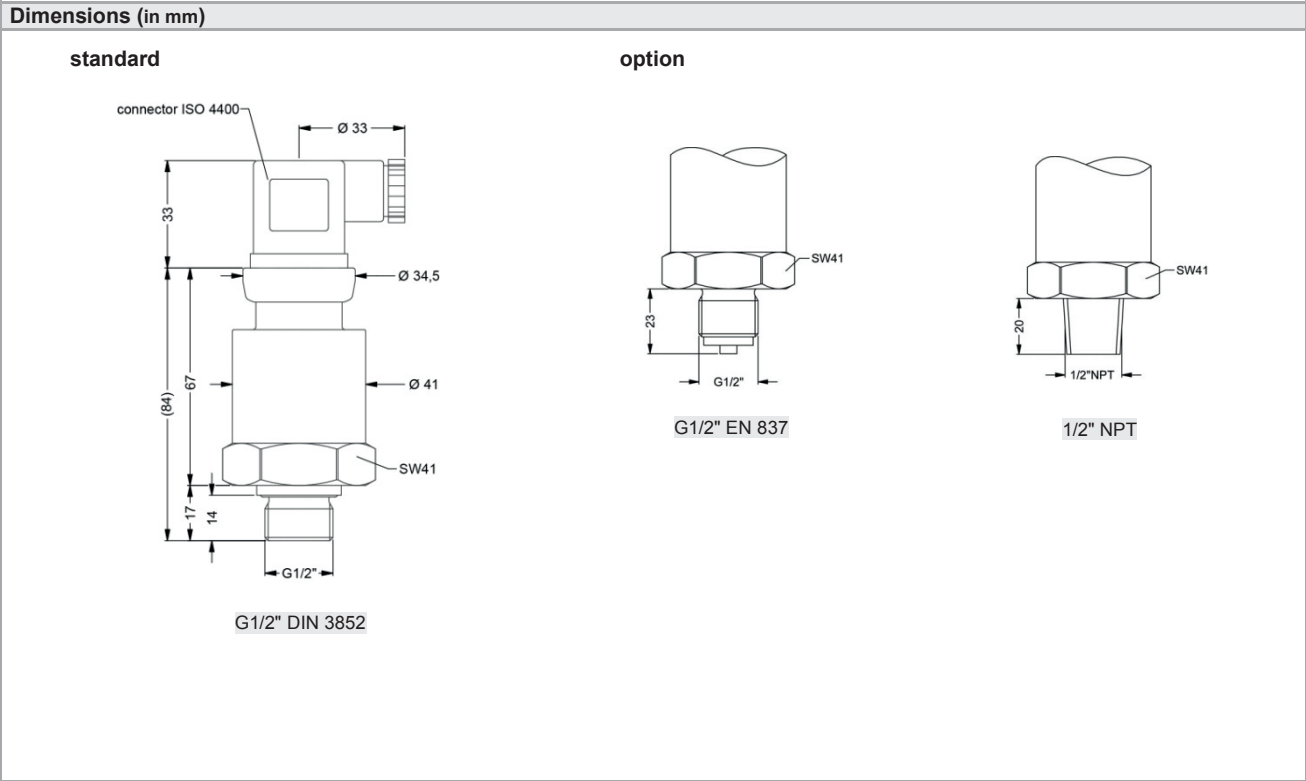

This document contains product specifications; properties are not guaranteed. Subject to change without notice.

## DMK 351



Pressure																				
	in bar, gauge	2	9	0																
	in bar, absolute	2	9	1																
	in bar, sealed gauge																			consult
	in mH <sub>2</sub> O, gauge	2	9	2																
	in mH <sub>2</sub> O, absolute	2	9	3																
	in mH <sub>2</sub> O, sealed gauge																			consult
Input		[mH <sub>2</sub> O]	[bar]																	
	0.4	0.04		0	4	0	0													
	0.6	0.06		0	6	0	0													
	1.0	0.10		1	0	0	0													
	1.6	0.16		1	6	0	0													
	2.5	0.25		2	5	0	0													
	4.0	0.40		4	0	0	0													
	6.0	0.60		6	0	0	0													
	10	1.0		1	0	0	1													
	16	1.6		1	6	0	1													
	25	2.5		2	5	0	1													
	40	4.0		4	0	0	1													
	60	6.0		6	0	0	1													
	100	10		1	0	0	2													
	160	16		1	6	0	2													
	200	20		2	0	0	2													
	customer			9	9	9	9													consult
Output																				
	4 ... 20 mA / 2-wire							1												
	0 ... 10 V / 3-wire							3												
	Intrinsic safety 4 ... 20 mA / 2-wire							E												
	customer							9												consult
Accuracy																				
	standard	0.35 %						3												
	option für P <sub>N</sub> ≥ 0.6 bar:	0.25 %						2												
	customer							9												consult
Electrical connection																				
	Male and female plug ISO 4400							1	0	0										
	Male plug Binder series 723 (5-pin)							2	0	0										
	Cable outlet with PVC cable <sup>1</sup>							T	A	0										
	Cable outlet with cable							T	R	0										
	Male plug M12x1 (4-pin) / metal							M	1	0										
	compact field housing							8	5	0										
	stainless steel 1.4305																			
	customer							9	9	9										consult
Mechanical connection																				
	G1/2" DIN 3852							1	0	0										
	G1/2" EN 837							2	0	0										
	1/2" NPT							N	0	0										
	customer							9	9	9										consult
Seals																				
	FKM										1									
	EPDM										3									
	customer										9									consult
Pressure port																				
	Stainless steel 1.4404 (316L)										1									
	customer										9									consult
Diaphragm																				
	Ceramics Al <sub>2</sub> O <sub>3</sub> 96%															2				
	Ceramics Al <sub>2</sub> O <sub>3</sub> 99.9 %															C				
	customer															9				consult
Special version																				
	standard															0	0	0		
	customer															9	9	9		consult

<sup>1</sup> standard: 2 m PVC cable without ventilation tube (permissible temperature: -5 ... 70 °C), optionally cable with ventilation tube



# DMK 331

## Industrial Pressure Transmitter

Ceramic Sensor

accuracy according to IEC 60770:  
0.5 % FSO

### Nominal pressure

from 0 ... 400 mbar up to 0 ... 600 bar

### Output signals

2-wire: 4 ... 20 mA

3-wire: 0 ... 20 mA / 0 ... 10 V

others on request

### Special characteristics

- ▶ pressure port G 1/2" flush for pasty and polluted media
- ▶ pressure port G 1/2" open port PVDF for aggressive media
- ▶ oxygen application





### Optional versions

- ▶ IS-version  
Ex ia = intrinsically safe for gases and dusts
- ▶ SIL 2  
according to IEC 61508 / IEC 61511
- ▶ customer specific versions

The industrial pressure transmitter DMK 331 with ceramic sensor has been especially designed for pasty, polluted or aggressive media and for oxygen applications at low pressure range.

As with all industrial pressure transmitters made by BD|SENSORS, you may choose between various electrical and mechanical connections also on DMK 331.

### Preferred areas of use are

-  Plant and Machine Engineering
-  Energy Industry
-  Environmental Engineering  
(water - sewage - recycling)
-  Medical Technology



Input pressure range <sup>1</sup>																		
Nominal pressure gauge [bar]	-1...0	0.4	0.6	1	1,6	2,5	4	6	10	16	25	40	60	100	160	250	400	600 <sup>2</sup>
Nominal pressure abs. [bar]	-	-	0.6	1	1,6	2,5	4	6	10	16	25	40	60	100	160	250	400	600 <sup>2</sup>
Overpressure [bar]	4	1	2	2	4	4	10	10	20	40	40	100	100	200	400	400	600	800
Burst pressure ≥ [bar]	7	2	4	4	5	5	12	12	25	50	50	120	120	250	500	500	650	880
Vacuum resistance	P <sub>N</sub> ≥ 1 bar: unlimited vacuum resistance												P <sub>N</sub> < 1 bar: on request					
<sup>1</sup> PVDF pressure port possible for nominal pressure ranges up to 60 bar																		
<sup>2</sup> nominal pressure 600 bar without UL certification																		
Output signal / Supply																		
Standard	2-wire: 4 ... 20 mA / V <sub>S</sub> = 8 ... 32 V <sub>DC</sub>																	
Option IS-protection	2-wire: 4 ... 20 mA / V <sub>S</sub> = 10 ... 28 V <sub>DC</sub>																	
Options 3-wire	3-wire: 0 ... 20 mA / V <sub>S</sub> = 14 ... 30 V <sub>DC</sub> 0 ... 10 V / V <sub>S</sub> = 14 ... 30 V <sub>DC</sub>																	
Performance																		
Accuracy <sup>3</sup>	≤ ± 0.5 % FSO																	
Permissible load	current 2-wire: R <sub>max</sub> = [(V <sub>S</sub> - V <sub>S min</sub> ) / 0.02 A] Ω												current 3-wire: R <sub>max</sub> = 500 Ω					
	voltage 3-wire: R <sub>min</sub> = 10 kΩ																	
Influence effects	supply: 0.05 % FSO / 10 V												load: 0.05 % FSO / kΩ					
Long term stability	≤ ± 0.3 % FSO / year at reference conditions																	
Response time	2-wire: ≤ 10 msec												3-wire: ≤ 3 msec					
<sup>3</sup> accuracy according to IEC 60770 – limit point adjustment (non-linearity, hysteresis, repeatability)																		
Thermal effects (Offset and Span) / Permissible Temperatures																		
Thermal error	≤ ± 0.2 % FSO / 10 K																	
in compensated range	-25 ... 85 °C																	
Permissible temperatures <sup>4</sup>	medium: -40 ... 125 °C						electronics / environment: -40 ... 85 °C						storage: -40 ... 100 °C					
<sup>4</sup> for pressure port of PVDF the minimum temperature is -30 °C																		
Electrical protection																		
Short-circuit protection	permanent																	
Reverse polarity protection	no damage, but also no function																	
Electromagnetic compatibility	emission and immunity according to EN 61326																	
Mechanical stability																		
Vibration	10 g RMS (25 ... 2000 Hz)						according to DIN EN 60068-2-6											
Shock	500 g / 1 msec						according to DIN EN 60068-2-27											
Materials																		
Pressure port	standard: stainless steel 1.4404 (316 L) optional for G1/2" open port with nominal pressure range up to 60 bar: PVDF others on request																	
Housing	stainless steel 1.4404 (316 L)																	
Option compact field housing	stainless steel 1.4305 (303) with cable gland brass, nickel plated												others on request					
Seals (media wetted)	standard: FKM						options: EPDM (for P <sub>N</sub> ≤ 160 bar), NBR						others on request					
Diaphragm	ceramic Al <sub>2</sub> O <sub>3</sub> 96 %																	
Media wetted parts	pressure port, seals, diaphragm																	
Explosion protection (only for 4 ... 20 mA / 2-wire)																		
Approval	<b>IBExU 10 ATEX 1068 X / IECEx IBE 12.0027X</b>																	
DX19-DMK 331	stainless steel pressure port: zone 0: II 1G Ex ia IIC T4 Ga zone 20: II 1D Ex ia IIIC T 85°C Da plastic pressure port: zone 1: II 2G Ex ia IIC T4 Ga zone 21: II 2D Ex ia IIIC T 85°C Da																	
Safety technical maximum values	U <sub>i</sub> = 28 V <sub>DC</sub> , I <sub>i</sub> = 93 mA, P <sub>i</sub> = 660 mW, C <sub>i</sub> ≈ 0 nF, L <sub>i</sub> ≈ 0 μH, the supply connections have an inner capacity of max. 27 nF to the housing																	
Permissible temperatures for environment	in zone 0: -20 ... 60 °C with p <sub>atm</sub> 0.8 bar up to 1.1 bar in zone 1 or higher: -20 ... 70 °C																	
Connecting cables (by factory)	cable capacitance: signal line/shield also signal line/signal line: 160 pF/m cable inductance: signal line/shield also signal line/signal line: 1 μH/m																	
Miscellaneous																		
Option SIL <sup>5</sup> 2	according to IEC 61508 / IEC 61511																	
Option oxygen application	for P <sub>N</sub> ≤ 15 bar: O-ring in 70 EPDM 281 (with BAM-approval); permissible maximum values are 15 bar / 60° C and 10 bar / 90° C for P <sub>N</sub> ≤ 25 bar: O-ring in FKM Vi 567 (with BAM-approval); permissible maximum values are 25 bar / 150° C																	
Current consumption	signal output current: max. 25 mA									signal output voltage: max. 7 mA								
Weight	approx. 140 g																	
Installation position	any																	
Operational life	> 100 x 10 <sup>6</sup> pressure cycles																	
CE-conformity	EMC Directive: 2004/108/EC									Pressure Equipment Directive: 97/23/EC (module A) <sup>6</sup>								
ATEX Directive	94/4/EG																	
<sup>5</sup> only for 4 ... 20 mA / 2-wire																		
<sup>6</sup> This directive is only valid for devices with maximum permissible overpressure > 200 bar																		

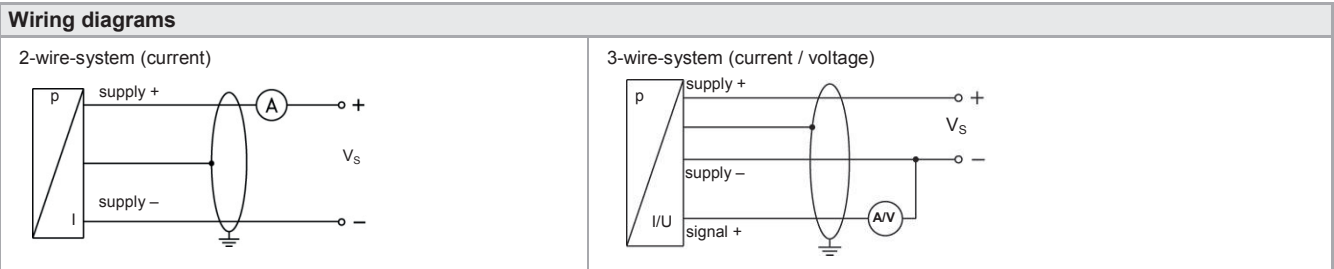

**Pin configuration**

Electrical connection	ISO 4400	Binder 723 (5-pin)	M12x1 / metal (4-pin)	field housing	cable colours (DIN 47100)
Supply +	1	3	1	IN +	wh (white)
Supply -	2	4	2	IN -	bn (brown)
Signal + (only for 3-wire)	3	1	3	OUT+	gn (green)
Shield	ground pin	5	4		ye/gn (yellow / green)

**Electrical connections (dimensions in mm)**

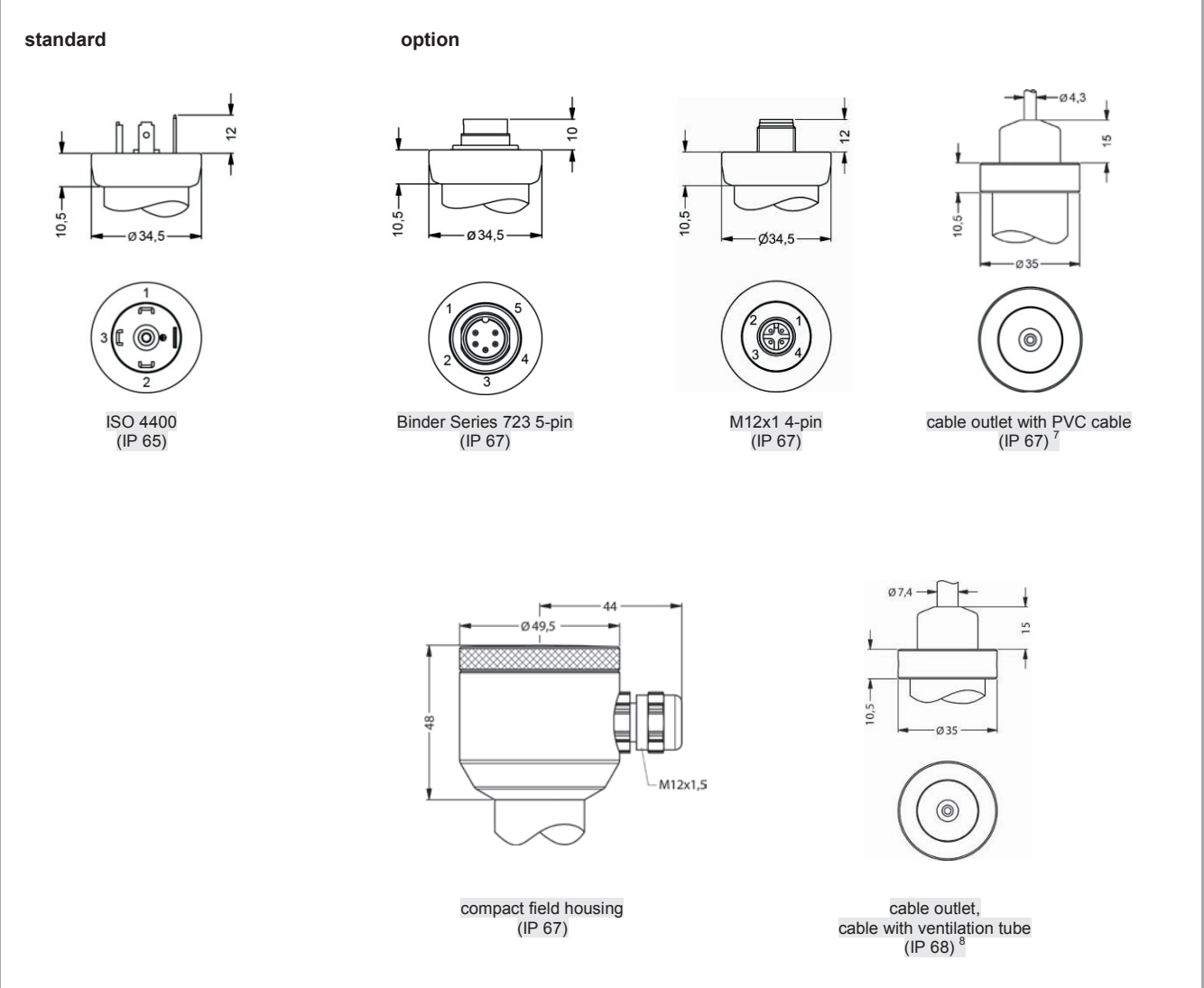

⇒ universal field housing stainless steel 1.4404 (316 L) with cable gland M20x1.5 (ordering code 880) and other versions on request

<sup>7</sup> standard: 2 m PVC cable without ventilation tube (permissible temperature: -5 ... 70°C)  
<sup>8</sup> different cable types and lengths available, permissible temperature depends on kind of cable

## Mechanical connection (dimensions in mm)

## standard

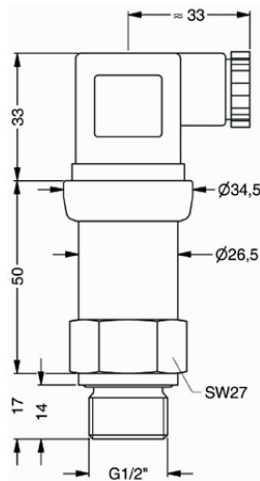
G1/2" DIN 3852  
with ISO 4400

## standard for SIL- and SIL-IS-version

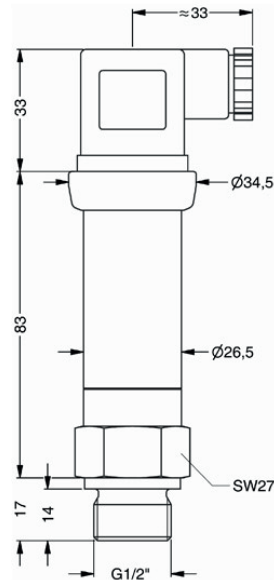
G1/2" DIN 3852  
with ISO 4400

## option

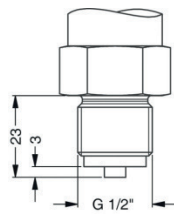

G1/2" EN 837

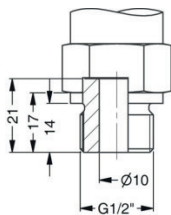

G1/2" open port

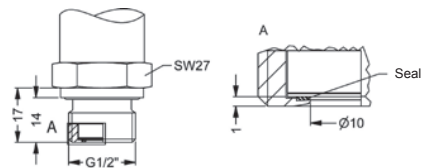
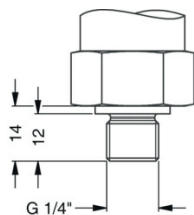
G1/2" semi-flush DIN 3852; M20x1.5<sup>9</sup>

G1/4" DIN 3852

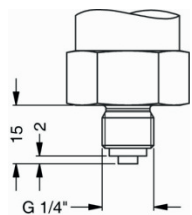

G1/4" EN 837

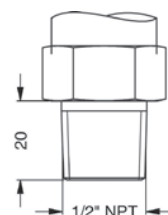

1/2" NPT

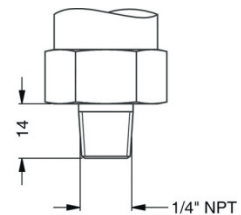

1/4" NPT

⇒ metric threads and other versions on request

<sup>9</sup> possible for nominal pressure ranges  $P_N \leq 25$  bar; absolute pressure ranges on request

### DMK 331



<b>Pressure</b>										
gauge	2	5	0							
absolute	2	5	1							
<b>Input</b>										
[bar]										
0.40			4	0	0	0				
0.60			6	0	0	0				
1.0			1	0	0	1				
1.6			1	6	0	1				
2.5			2	5	0	1				
4.0			4	0	0	1				
6.0			6	0	0	1				
10			1	0	0	2				
16			1	6	0	2				
25			2	5	0	2				
40			4	0	0	2				
60			6	0	0	2				
100			1	0	0	3				
160			1	6	0	3				
250			2	5	0	3				
400			4	0	0	3				
600			6	0	0	3				
-1 ... 0			X	1	0	2				
customer			9	9	9	9			consult	
<b>Output</b>										
4 ... 20 mA / 2-wire							1			
0 ... 20 mA / 3-wire							2			
0 ... 10 V / 3-wire							3			
Intrinsic safety 4 ... 20 mA / 2-wire							E			
SIL2 4 ... 20 mA / 2-wire							1S			
SIL2 with Intrinsic safety 4 ... 20 mA / 2-wire							ES			
customer							9		consult	
<b>Accuracy</b>										
0.5 %							5			
customer							9		consult	
<b>Electrical connection</b>										
Male and female plug ISO 4400							1	0	0	
Male plug Binder series 723 (5-pin)							2	0	0	
Cable outlet with PVC cable <sup>1</sup>							T	A	0	
Cable outlet with cable							T	R	0	
Male plug M12x1 (4-pin) / metal compact field housing stainless steel 1.4404 (316L)							8	5	0	
customer							9	9	9	
<b>Mechanical connection</b> <sup>2</sup>										
G1/2" DIN 3852							1	0	0	
G1/2" EN 837							2	0	0	
G1/4" DIN 3852							3	0	0	
G1/4" EN 837							4	0	0	
G1/2" DIN 3852 with <sup>3</sup> semi-flush sensor							F	0	0	
G1/2" DIN 3852 open pressure port							H	0	0	
1/2" NPT							N	0	0	
1/4" NPT							N	4	0	
customer							9	9	9	
<b>Seals</b>										
FKM									1	
EPDM <sup>4</sup>									3	
NBR									5	
customer									9	
<b>Pressure port</b>										
Stainless steel 1.4404 (316L)									1	
PVDF <sup>5</sup>									B	
customer									9	
<b>Diaphragm</b>										
Ceramics Al <sub>2</sub> O <sub>3</sub> 96%									2	
customer									9	
<b>Special version</b>										
standard								0	0	0
oxygen application <sup>6</sup>								0	0	7
customer								9	9	9

<sup>1</sup> standard: 2 m PVC cable without ventilation tube (permissible temperature: -5 ... 70°C)

<sup>2</sup> metric threads and others on request

<sup>3</sup> possible for nominal pressure ranges P<sub>N</sub> ≤ 25 bar; absolute pressure ranges on request

<sup>4</sup> possible for nominal pressure range P<sub>N</sub> ≤ 160 bar

<sup>5</sup> PVDF only with G1/2" DIN 3852 open pressure port (up to 60 bar), minimum permissible temperature is -30 °C

<sup>6</sup> oxygen application with FKM-seal up to 25 bar and with EPDM-seal up to 15 bar possible

This document contains product specifications; properties are not guaranteed. Detailed information about options are defined in the datasheet. Subject to change without notice.



# DMP 457

## Pressure Transmitter for Shipbuilding and Offshore

Stainless Steel Sensor

accuracy according to IEC 60770:  
standard: 0.35 % FSO  
option: 0.25 % FSO

### Nominal pressure

from 0 ... 100 mbar up to 0 ... 600 bar

### Output signals

2-wire: 4 ... 20 mA  
others on request

### Special characteristics

- ▶ shipping approvals  
GL (Germanischer Lloyd),  
DNV (Det Norske Veritas) and  
CCS (China Classification Society)
- ▶ flush pressure port  
G 1/2" from 100 mbar
- ▶ excellent thermal behavior

### Optional versions

- ▶ IS-version  
Ex ia = intrinsically safe for gases and  
dusts
- ▶ welded pressure port

The pressure transmitter DMP 457 has been especially designed for rough conditions occurring especially in shipbuilding and offshore applications. All gaseous and liquid media, which are compatible with stainless steel 1.4404 (316L) respectively can be used.

Sensor element is a piezoresistive stainless steel sensor with high accuracy and excellent long-term stability. In order to meet the special requirements for shipbuilding and offshore applications extensive tests had to be passed to get the Germanischer Lloyd (GL), Det Norske Veritas (DNV) and China Classification Society (CCS) approvals.

### Preferred areas of use are



Diesel Engines, Drives  
Compressors, Pumps  
Boiler  
Hydraulic and Pneumatic Control  
Systems



Fuel and Oil





Input pressure range <sup>1</sup>												
Nominal pressure gauge	[bar]	-1 ... 0	0.10	0.16	0.25	0.40	0.60	1	1.6	2.5	4	6
Nominal pressure abs.	[bar]	-	0.10	0.16	0.25	0.40	0.60	1	1.6	2.5	4	6
Level gauge / abs.	[mH <sub>2</sub> O]	-	1	1.6	2.5	4	6	10	16	25	40	60
Overpressure	[bar]	5	0.5	1	1	2	5	5	10	10	20	40
Burst pressure ≥	[bar]	7.5	1.5	1.5	1.5	3	7.5	7.5	15	15	25	50

Nominal pressure gauge	[bar]	10	16	25	40	60	100	160	250	400	600
Nominal pressure abs.	[bar]	10	16	25	40	60	100	160	250	400	600
Level gauge / abs.	[mH <sub>2</sub> O]	100	160	250	400	-	-	-	-	-	-
Overpressure	[bar]	40	80	80	105	210	600	600	1000	1000	1000
Burst pressure ≥	[bar]	50	120	120	210	420	1000	1000	1250	-	-
Vacuum resistance		P <sub>N</sub> ≥ 1 bar: unlimited vacuum resistance P <sub>N</sub> < 1 bar: on request									
<sup>1</sup> from 60 bar: measurement starts with ambient pressure											

Output signal / Supply	
Standard	2-wire: 4 ... 20 mA / V <sub>S</sub> = 8 ... 32 V <sub>DC</sub>
Option IS-protection	2-wire: 4 ... 20 mA / V <sub>S</sub> = 10 ... 28 V <sub>DC</sub>
Performance	
Accuracy <sup>2</sup>	Standard: Nominal pressure < 0.4 bar: ≤ ± 0.5 % FSO Nominal pressure ≥ 0.4 bar: ≤ ± 0.35 % FSO Option: Nominal pressure ≥ 0.4 bar: ≤ ± 0.25 % FSO
Permissible load	R <sub>max</sub> = [(V <sub>S</sub> - V <sub>Smin</sub> ) / 0.02 A] Ω
Influence effects	supply: 0.05 % FSO / 10 V load: 0.05 % FSO / kΩ
Long term stability	≤ ± 0.1 % FSO / year by reference conditions
Response time	< 10 msec
<sup>2</sup> accuracy according to IEC 60770 – limit point adjustment (non-linearity, hysteresis, repeatability)	
Thermal effects (Offset and Span) / Permissible temperatures	
Nominal pressure P <sub>N</sub>	[bar] -1 ... 0 < 0.4 ≥ 0.4
Tolerance band	[% FSO] ≤ ± 0.75 ≤ ± 1 ≤ ± 0.75
in compensated range	[°C] -20 ... 85 0 ... 70 -20 ... 85
Permissible temperatures	medium: -40 ... 125°C electronics / environment: -40 ... 85°C storage: -40 ... 100°C
Electrical protection	
Short-circuit protection	permanent
Reverse polarity protection	no damage, but also no function
Electromagnetic compatibility	emission and immunity according to - EN 61326 - Germanischer Lloyd (GL) - Det Norske Veritas (DNV)
Mechanical stability	
Vibration	4 g (according to GL: curve 2 / according to DNV: Class B / basis: IEC 60068-2-6)
Materials	
Pressure port	stainless steel 1.4404 (316L)
Housing	standard: stainless steel 1.4404 (316L) option field housing: stainless steel 1.4404 (316L), with cable gland
Cable sheath	for cable outlet for submersible version permissible temperatures PVC - cable PUR - cable - PUR - probe cable FEP - probe cable TPE - probe cable -5 ... 70 °C -25 ... 70 °C -25 ... 70 °C -25 ... 125 °C
Seals (media wetted)	standard: FKM option: NBR, welded version <sup>3</sup> others on request
Diaphragm	stainless steel 1.4435 (316L)
Media wetted parts	pressure port, seals, diaphragm
<sup>3</sup> welded version only with pressure ports according to EN 837; possible for nominal pressure ranges P <sub>N</sub> ≤ 40 bar	
IS-protection	
Approvals DX 19-DMP 457	<b>IBExU 10 ATEX 1068 X / IECEx IBE 12.0027X</b> zone 0: II 1G Ex ia IIB T4 Ga zone 20: II 1D Ex ia IIIC T 85°C Da
Safety technical maximum values	U <sub>i</sub> = 28 V, I <sub>i</sub> = 93 mA, P <sub>i</sub> = 660 mW, C <sub>i</sub> = 105 nF, L <sub>i</sub> = 5 μH, the supply connections have an inner capacity of max. 140 nF to the housing
Permissible temperatures for environment	in zone 0: -20 ... 60 °C bei p <sub>atm</sub> 0.8 bar bis 1.1 bar in zone 1 or higher: -20 ... 70 °C
Connecting cables (by factory)	cable capacitance: signal line/shield also signal line/signal line: 160 pF/m cable inductance: signal line/shield also signal line/signal line: 1 μH/m

**Miscellaneous**

Current consumption	max. 25 mA
Weight	approx. 140 g (with ISO 4400)
Installation position	any <sup>4</sup>
Operational life	> 100 x 10 <sup>6</sup> pressure cycles
CE-conformity	EMC Directive: 2004/108/EC Pressure Equipment Directive: 97/23/EC (module A) <sup>5</sup>
ATEX Directive	94/9/EC

<sup>4</sup> Pressure transmitters are calibrated in a vertical position with the pressure connection down. If this position is changed on installation there can be slight deviations in the zero point for pressure ranges  $P_N \leq 1$  bar.

<sup>5</sup> This directive is only valid for devices with maximum permissible overpressure > 200 bar

**Wiring diagram**

2-wire-system (current)

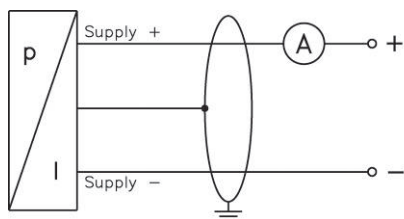
**Pin configuration**

Electrical connection	ISO 4400	field housing	cable colours (DIN 47100)
Supply +	1	IN +	wh (white)
Supply -	2	IN -	bn (brown)
Shield	ground pin	$\perp$	ye/gn (yellow / green)

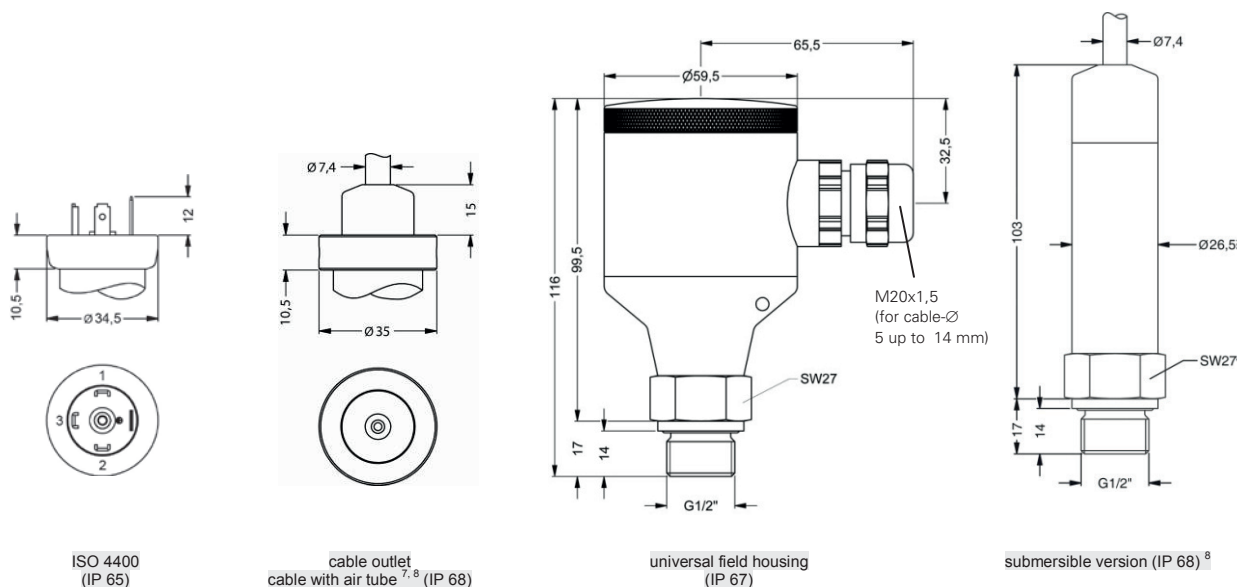
**Electrical connections<sup>6</sup> (dimensions in mm)**

<sup>6</sup> Generally shielded cable has to be used! Cable versions are delivered with shielded cable. For ISO 4400 the use of shielded cable is compulsory.

<sup>7</sup> tested at 4 bar or 40 mH<sub>2</sub>O for 24 hours

<sup>8</sup> different cable types and lengths available, permissible temperature depends on kind of cable, see cable connection

### Mechanical connection (dimensions in mm)

#### Standard

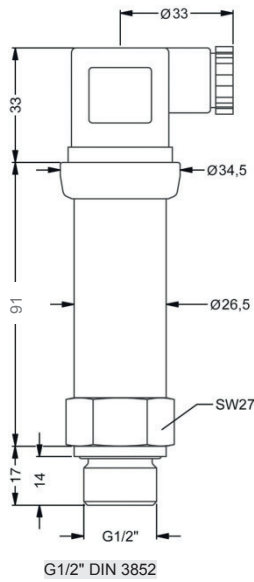

#### Option

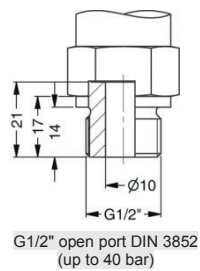
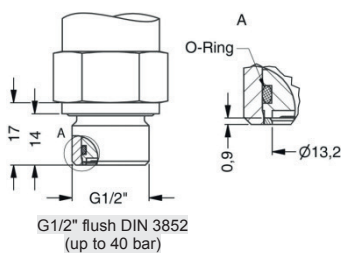
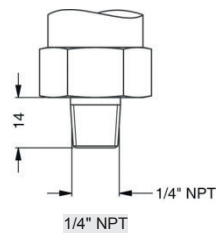
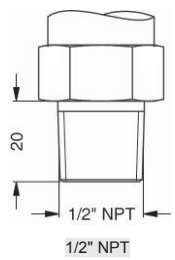
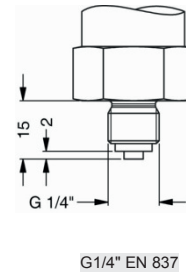
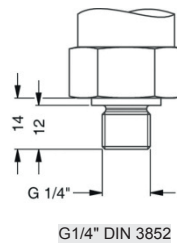
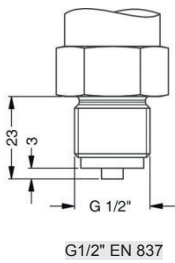





# DMK 458

## Pressure Transmitter for Marine and Offshore

Ceramic Sensor

accuracy according to IEC 60770:  
standard: 0.25 % FSO  
option: 0.1 % FSO

### Nominal pressure

from 0 ... 40 mbar up to 0 ... 20 bar

### Output signals

2-wire: 4 ... 20 mA  
Others on request

### Product characteristics

- ▶ GL-shipping approval (Germanischer Lloyd)
- ▶ DVN-certificate (Det Norske Veritas)
- ▶ CCS-certificate (China Classification Society)
- ▶ high overpressure resistance
- ▶ excellent long term stability



### Optionale Ausführungen

- ▶ IS-version  
Ex ia= intrinsically safe for gases and dusts
- ▶ diaphragm Al<sub>2</sub>O<sub>3</sub> 99.9 %
- ▶ pressure port CuNiFe

The pressure transmitter DMK 458 has been developed for marine and offshore applications. In addition to thread connections, different flush versions are available, which are especially suitable for pasty, viscous, and polluted media.

Due to the capacitive ceramic sensor developed by BD|SENSORS, which is optionally available in Al<sub>2</sub>O<sub>3</sub> 99.9 %, the DMK 458 shows an outstanding accuracy as well as a high overload and temperature resistance.

### Preferred areas of use are

-  Monitoring of pressure during loading and unloading processes
-  Monitoring of a ship's position and draught
- Use in anti-heeling systems
-  Level measurement in ballast and storage tanks



Pressure ranges																
Nominal pressure <sup>1</sup>	[bar]	0.04	0.06	0.1	0.16	0.25	0.4	0.6	1	1.6	2.5	4	6	10	16	20
Level	[mH <sub>2</sub> O]	0.4	0.6	1	1.6	2.5	4	6	10	16	25	40	60	100	160	200
Overpressure	[bar]	2	2	4	4	6	6	8	8	15	25	25	35	35	45	45
Permissible vacuum	[bar]	-0.2		-0.3		-0.5				-1						

<sup>1</sup> available in gauge, sealed gauge and absolute; nominal pressure ranges sealed gauge and absolute from 1 bar

Output signal / Supply	
Standard	2-wire: 4 ... 20 mA / V <sub>S</sub> = 9 ... 32 V <sub>DC</sub> V <sub>S rated</sub> = 24 V <sub>DC</sub>
Option IS-version	2-wire: 4 ... 20 mA / V <sub>S</sub> = 14 ... 28 V <sub>DC</sub> V <sub>S rated</sub> = 24 V <sub>DC</sub>
Performance	
Accuracy <sup>2</sup>	standard: ≤ ± 0.25 % FSO option: for P <sub>N</sub> ≥ 0.6 bar <sup>3</sup> : ≤ ± 0.1 % FSO
Permissible load	R <sub>max</sub> = [(V <sub>S</sub> - V <sub>S min</sub> ) / 0.02 A] Ω
Long term stability	≤ ± 0.1 % FSO / year
Influence effects	supply: 0.05 % FSO / 10 V load: 0.05 % FSO / kΩ
Turn-on time	700 msec
Mean response time	< 200 msec
Max. response time	380 msec
	mean measuring rate 5/sec
<sup>2</sup> accuracy according to IEC 60770 – limit point adjustment (non-linearity, hysteresis, repeatability)	
<sup>3</sup> Under the influence of disturbance burst according to EN 61000-4-4 (2004) 2 kV accuracy decreases on ≤ ± 0.25 % FSO.	
Thermal effects	
Thermal error	≤ ± 0.1 % FSO / 10 K      in compensated range -20 ... 80 °C
Permissible temperatures	
Permissible temperatures	medium: -40 ... 125 °C electronics / environment: -25 ... 85 °C storage: -40 ... 100 °C
Electrical protection	
Short-circuit protection	permanent
Reverse polarity protection	no damage, but also no function
Electromagnetic compatibility	emission and immunity according to EN 61326 and Germanischer Lloyd (GL)
Mechanical stability	
Vibration	4 g (according to GL: curve 2 / basis: DIN EN 60068-2-6)
Materials	
Pressure port	standard: stainless steel 1.4404 (316 L) option for threaded connections: CuNi10Fe1Mn - on request
Housing	stainless steel 1.4404 (316 L)
Cable sheath for version cable outlet	PUR
Cable gland for version field housing	absolute, sealed gauge: brass, nickel plated gauge: polyamide (with integrated pressure reference)
Seals (media wetted)	FKM
Diaphragm	standard: ceramics Al <sub>2</sub> O <sub>3</sub> 96 % option: ceramics Al <sub>2</sub> O <sub>3</sub> 99.9 %
Media wetted parts	pressure port, seals, diaphragm
IS protection	
Approval DX14A-DMK 458	IBExU 07 ATEX 1180 X field housing      zone 0: II 1G Ex ia IIC T4 ISO 4400, M12x1, cable outlet:      zone 0: II 1G Ex ia IIB T4
Safety technical maximum values	U <sub>i</sub> = 28 V; I <sub>i</sub> = 93 mA; P <sub>i</sub> = 660 mW field housing:      C <sub>i</sub> = 52.3 nF; L <sub>i</sub> = 5 µH; 90.2 nF opposite GND ISO 4400, M12x1, cable outlet:      C <sub>i</sub> = 105 nF; L <sub>i</sub> = 5 µH; 140 nF opposite GND
Permissible temperatures for environment	in zone 0: -20 ... 60 °C with p <sub>atm</sub> 0.8 bar up to 1.1 bar zone 1 and higher: -25 ... 70 °C
Permissible temperatures for medium	-40 ... 85 °C
Miscellaneous	
Ingress protection	IP65, IP 67, IP68
Installation position	any
Current consumption	max. 21 mA
Weight	min. 400 g (depending on housing and mechanical connection)
Operational life	> 100 x 10 <sup>6</sup> cycles
CE conformity	EMC Directive: 2004/108/EC
ATEX Directive	94/9/EC

**Wiring diagram**

2-wire-system (current)

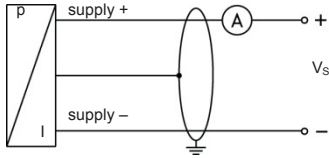

**Pin configuration**

Electrical connections	ISO 4400	field housing (clamp section: 2.5 mm <sup>2</sup> )	M12x1 (4-pin) metal	cable colours (DIN 47100)
Supply +	1	VS+	1	wh (white)
Supply -	2	VS-	2	bn (brown)
Shield	ground contact		4	ye/gn (yellow / green)

**Electrical connections (dimensions in mm)**

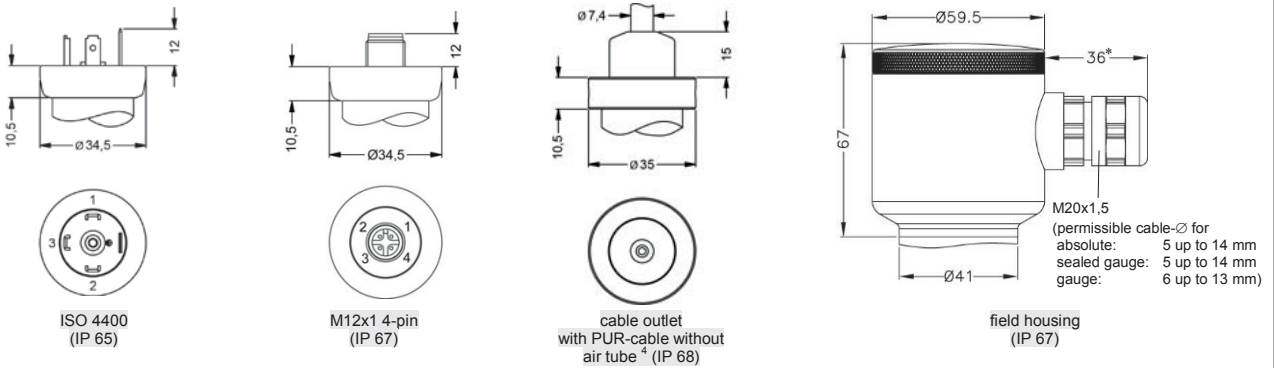

\* for gauge pressure ranges with field housing the marked dimension increases by 8 mm

<sup>4</sup> cable versions are delivered with shielded cable (different cable types and lengths available);  
for gauge pressure cable with ventilation tube required; tested at 4 bar or 40 mH<sub>2</sub>O for 24 hours

**Dimensions (in mm)**

Inch thread

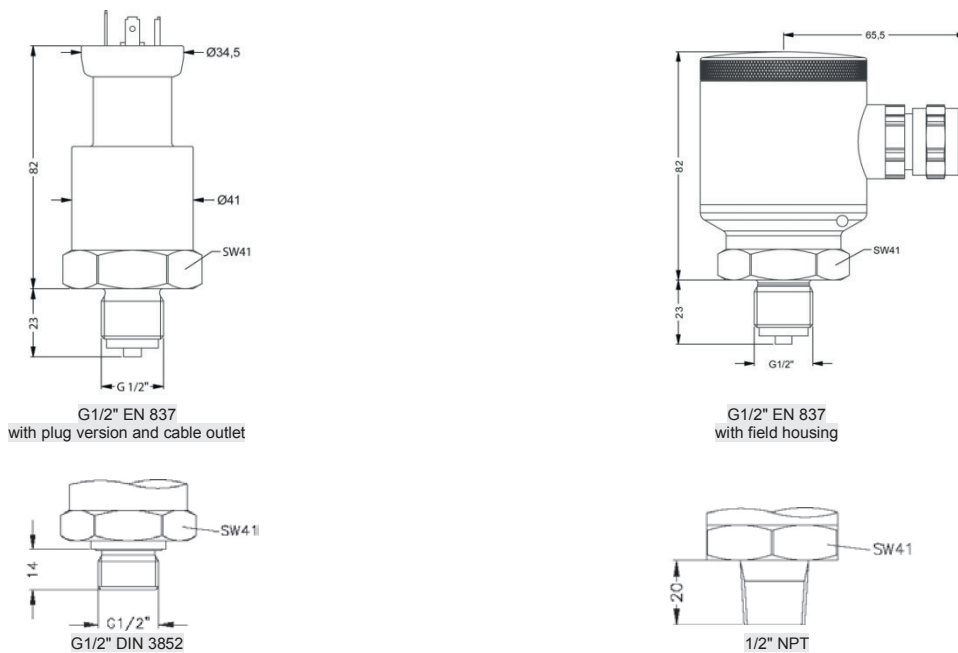

⇒ For version field housing with pressure port in CuNi10Fe1Mn, total length increases by 27 mm!

## Dimensions (in mm)

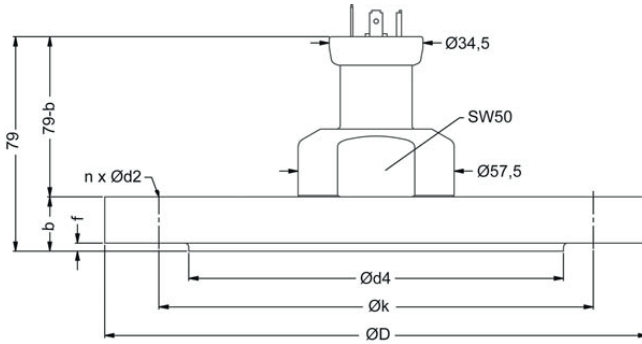
Flange <sup>5</sup> (DIN 2501)

with plug version and cable outlet

dimensions in mm				
Maß	DN25/PN40	DN40/PN40	DN50/PN40	DN80/PN16
D	115	150	165	200
k	85	110	125	160
d4	68	88	102	138
b	18	18	20	20
f	2	3	3	3
n	4	4	4	8
d2	14	18	18	18

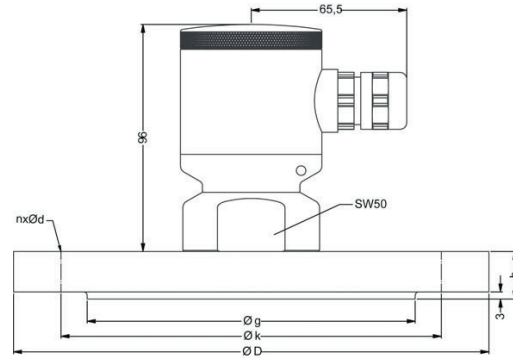

with field housing

dimensions in mm				
Maß	DN25/PN40	DN40/PN40	DN50/PN40	DN80/PN16
D	115	150	165	200
k	85	110	125	160
g	68	88	102	138
b	18	18	20	20
n	4	4	4	8
d	14	18	18	18

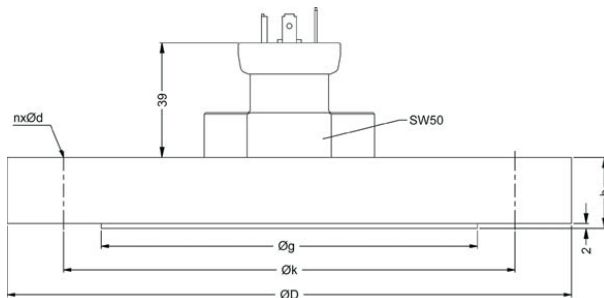
Flange <sup>5</sup> (ANSI)

with plug version and cable outlet

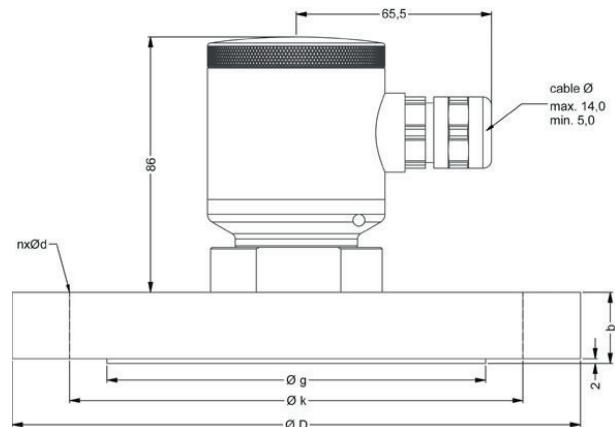

with field housing

dimensions in mm		
size	2"/150 lbs	3"/150 lbs
D	152.4	190.5
g	91.9	127
k	120.7	152.4
b	19.1	23.9
n	4	4
d	19.1	19.1

⇒ For version field housing with pressure port in CuNi10Fe1Mn, total length increases by 27 mm!

<sup>5</sup> DN80/PN16 possible for nominal pressure ranges  $P_N \leq 16$  bar; 2"/150 lbs and 3"/150 lbs possible for nominal pressure ranges  $P_N \leq 10$  bar



DMK 458

□□□ - □□□□ - □ - □ - □□□□ - □□□□ - □ - □ - □ - □□□□

<b>Pressure</b>																		
	in bar, gauge	5	9	A														
	in bar, absolute <sup>1</sup>	5	9	B														
	in bar, sealed gauge <sup>1</sup>	5	9	E														consult
	in mH <sub>2</sub> O, gauge	5	9	C														
	in mH <sub>2</sub> O, absolute <sup>1</sup>	5	9	D														consult
	in mH <sub>2</sub> O, sealed gauge <sup>1</sup>	5	9	F														consult
<b>Input</b>																		
	[mH <sub>2</sub> O]																	
	[bar]																	
	0.4	0.04			0	4	0	0										
	0.6	0.06			0	6	0	0										
	1.0	0.1			1	0	0	0										
	1.6	0.16			1	6	0	0										
	2.5	0.25			2	5	0	0										
	4.0	0.40			4	0	0	0										
	6.0	0.60			6	0	0	0										
	10	1.0			1	0	0	1										
	16	1.6			1	6	0	1										
	25	2.5			2	5	0	1										
	40	4.0			4	0	0	1										
	60	6.0			6	0	0	1										
	100	10			1	0	0	2										
	160	16			1	6	0	2										
	200	20			2	0	0	2										
	customer				9	9	9	9										consult
<b>Output</b>																		
	4 ... 20 mA / 2-wire								1									
	Intrinsic safety 4 ... 20 mA / 2-wire								E									
	customer								9									consult
<b>Accuracy</b>																		
	standard: 0.25%									2								
	option for P <sub>n</sub> > 0.6 bar: 0.1%									1								
	customer									9								consult
<b>Electrical connection</b>																		
	Male and female plug ISO 4400 <sup>2</sup>																	
	(for cable Ø 4 ... 6 mm)									G	1	0						
	Male and female plug ISO 4400 GL <sup>2</sup>																	
	(for cable Ø 10 ... 14 mm)									G	0	0						
	Male and female plug ISO 4400 GL <sup>2</sup>																	
	(for cable Ø 4.5 ... 11 mm)									G	0	1						
	Male plug M12x1 (4-pin) / metal version									M	1	0						
	Cable outlet with PUR-cable (with ventilation tube)									T	R	1						
	Field housing, absolute, sealed gauge									8	8	0						
	customer									9	9	9						consult
<b>Mechanical connection</b>																		
	G 1/2" DIN 3852									1	0	0						
	G 1/2" EN 837									2	0	0						
	1/2" NPT									N	0	0						
	Flange DN 25 / PN 40 (DIN 2501)									F	2	0						
	Flange DN 40 / PN 40 (DIN 2501)									F	2	2						
	Flange DN 50 / PN 40 (DIN 2501)									F	2	3						
	Flange DN 80 / PN 16 (DIN 2501) <sup>3</sup>									F	1	4						
	Flange DN 2" / 150 lbs (ANSI B 16.5)									F	3	2						
	Flange DN 3" / 150 lbs (ANSI B 16.5)									F	3	3						
	customer									9	9	9						consult
<b>Seals</b>																		
	FKM																	
	andere																	consult
<b>Pressure port</b>																		
	Stainless steel 1.4404 (316L)																	
	Copper-Nickel-alloy (CuNi10Fe1Mn) <sup>4</sup>																	consult
	customer																	consult
<b>Diaphragm</b>																		
	Ceramics Al <sub>2</sub> O <sub>3</sub> 96%																	
	Ceramics Al <sub>2</sub> O <sub>3</sub> 99.9%																	
	customer																	consult
<b>Special version</b>																		
	standard																	
	customer																	consult

<sup>1</sup> nominal pressure ranges absolute and sealed gauge from 1 bar

<sup>2</sup> female plug is GL-approved

<sup>3</sup> DN80/PN16 possible for nominal pressure ranges PN ≤ 16 bar; 2"/150 lbs and 3"/150 lbs possible for nominal pressure ranges PN ≤ 10 bar

<sup>4</sup> CuNi10Fe1Mn only possible in combination with inch thread

This document contains product specifications; properties are not guaranteed. Detailed information about options are defined in the datasheet. Subject to change without notice.



# DMK 457

## Pressure Transmitter for Shipbuilding and Offshore

Ceramic Sensor

accuracy according to IEC 60770:  
0.5 % FSO

### Nominal pressure

from 0 ... 400 mbar up to 0 ... 600 bar

### Output signals

2-wire: 4 ... 20 mA  
others on request

### Special characteristics

- ▶ shipping approvals  
GL (Germanischer Lloyd),  
DNV (Det Norske Veritas) and  
CCS (China Classification Society)
- ▶ pressure port CuNiFe  
(sea water resistant)
- ▶ oxygen application

### Optional versions



- ▶ IS-version  
Ex ia = intrinsically safe for gases and  
dusts

The pressure transmitter DMK 457 with ceramic sensor has been designed for typical applications in shipbuilding and offshore constructions as alternative to our pressure transmitter DMP 457 with piezoresistive stainless steel sensor.

In combination with the copper-nickel-alloy the DMK 457 is suitable for seawater, e.g. level measurement in ballast tanks, etc.

The DMK 457 is approved by Germanischer Lloyd (GL), Det Norske Veritas (DNV) and China Classification Society (CCS).

### Preferred areas of use are

-  Drives  
Compressors  
Boiler  
Pneumatic Control Systems  
Oxygen Applications
-  Fuel and Oil
-  Water and Sea Water



Input pressure range																		
Nominal pressure gauge [bar]	-1 ... 0	0.4	0.6	1	1.6	2.5	4	6	10	16	25	40	60	100	160	250	400	600
Nominal pressure abs. [bar]	-	-	0.6	1	1.6	2.5	4	6	10	16	25	40	60	100	160	250	400	600
Level gauge / abs. [mH <sub>2</sub> O]	-	-	6	10	16	25	40	60	100	160	250	400	600	-	-	-	-	-
Overpressure [bar]	4	1	2	2	4	4	10	10	20	40	40	100	100	200	400	400	600	800
Burst pressure ≥ [bar]	7	2	4	4	5	5	12	12	25	50	50	120	120	250	500	500	650	880
Vacuum resistance	P <sub>N</sub> ≥ 1 bar: unlimited vacuum resistance P <sub>N</sub> < 1 bar: on request																	

Output signal / Supply	
Standard	2-wire: 4 ... 20 mA / V <sub>S</sub> = 8 ... 32 V <sub>DC</sub>
Option IS-protection	2-wire: 4 ... 20 mA / V <sub>S</sub> = 10 ... 28 V <sub>DC</sub>

Performance	
Accuracy <sup>1</sup>	IEC 60770: ≤ ± 0.5 % FSO
Permissible load	R <sub>max</sub> = [(V <sub>S</sub> - V <sub>Smin</sub> ) / 0.02 A] Ω
Influence effects	supply: 0.05 % FSO / 10 V load: 0.05 % FSO / kΩ
Response time	< 10 msec

<sup>1</sup> accuracy according to IEC 60770 – limit point adjustment (non-linearity, hysteresis, repeatability)

Thermal effects (Offset and Span) / Permissible temperatures	
Thermal error	≤ ± 0.2 % FSO / 10 K in compensated range: -25 ... 85 °C
Permissible temperatures	medium: -40 ... 125 °C electronics / environment: -40 ... 85 °C storage: -40 ... 100 °C

Electrical protection	
Short-circuit protection	permanent
Reverse polarity protection	no damage, but also no function
Electromagnetic compatibility	emission and immunity according to - EN 61326 - Germanischer Lloyd (GL) - Det Norske Veritas (DNV)

Mechanical stability	
Vibration	4 g (according to GL: curve 2 / according to DNV: Class B / basis: IEC 60068-2-6)

Materials			
Pressure port	Standard:	stainless steel 1.4404 (316L)	
	option <sup>2</sup> :	CuNi10Fe1Mn (sea water resistant) - for P <sub>N</sub> ≤ 400 bar with mech. connection G1/2" DIN 3852, G1/2" EN 837, G1/2" open port, G1/4" DIN 3852, G1/4" EN 837 in combination with housing in CuNi10Fe1Mn	
Housing	standard:	stainless steel 1.4404 (316L)	
	option <sup>2</sup> :	CuNi10Fe1Mn (sea water resistant) - in combination with pressure port in CuNi10Fe1Mn	
Cable sheath	option field housing:	stainless steel 1.4404 (316L); with cable gland	
		for cable outlet	for submersible version
	PVC - cable	-	-5 ... 70 °C
	PUR - cable	PUR - probe cable	-25 ... 70 °C
		FEP - probe cable	-25 ... 70 °C
		TPE - probe cable	-25 ... 125 °C
Seals (media wetted)	standard:	FKM	
	option:	NBR, FFKM (only for P <sub>N</sub> ≤ 100 bar)	
	others on request		
Diaphragm	ceramic Al <sub>2</sub> O <sub>3</sub> 96 %		
Media wetted parts	pressure port, seals, diaphragm		

<sup>2</sup> IS-version on request

IS-protection (only for 4 ... 20 mA / 2-wire)	
Approvals DX19-DMK 457	<b>IBExU 10 ATEX 1068 X / IECEx IBE 12.0027X</b> zone 0: II 1G Ex ia IIB T4 Ga zone 20: II 1D Ex ia IIIC T 85°C Da
Safety technical maximum values	U <sub>i</sub> = 28 V, I <sub>i</sub> = 93 mA, P <sub>i</sub> = 660 mW, C <sub>i</sub> = 105 nF, L <sub>i</sub> = 5 μH, the supply connections have an inner capacity of max. 140 nF to the housing
Permissible media temperature	in zone 0: -20 ... 60 °C with p <sub>atm</sub> 0.8 bar up to 1.1 bar in zone 1 or higher: -20 ... 70 °C
Connecting cables (by factory)	cable capacitance: signal line/shield also signal line/signal line: 160 pF/m cable inductance: signal line/shield also signal line/signal line: 1μH/m

**Miscellaneous**

Option oxygen application	for $P_N \leq 25$ bar: O-ring in FKM Vi 567 (with BAM-approval); permissible maximum values are 25 bar / 150° C
Current consumption	max. 25 mA
Weight	approx. 140 g (with ISO 4400)
Installation position	any
Operational life	> 100 x 10 <sup>6</sup> pressure cycles
CE-conformity	EMC Directive: 2004/108/EC Pressure Equipment Directive: 97/23/EC (module A) <sup>3</sup>
ATEX-directive	94/9/EC

<sup>3</sup> This directive is only valid for devices with maximum permissible overpressure > 200 bar

**Wiring diagram**

2-wire-system (current)

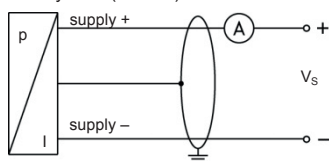
**Pin configuration**

Electrical connection	ISO 4400	Field housing	Cable colours (DIN 47100)
Supply +	1	IN +	wh (white)
Supply -	2	IN -	bn (brown)
Shield	ground pin	⊥	ye/gn (yellow / green)

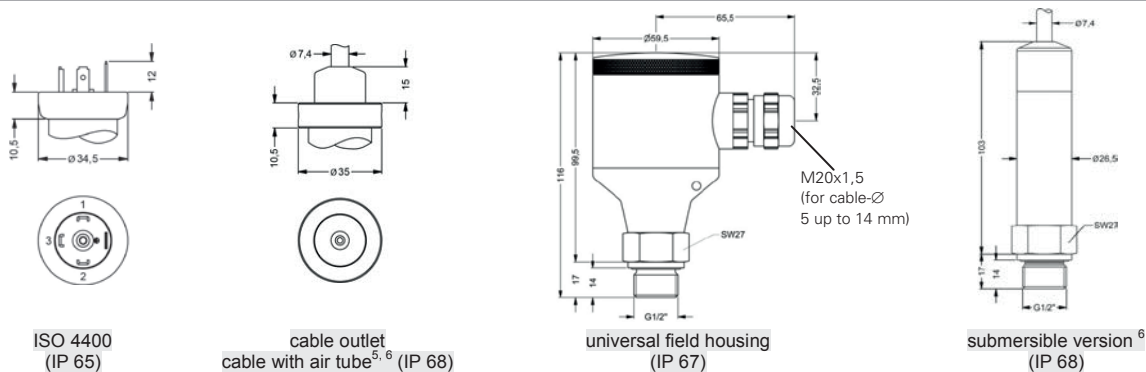
**Electrical connections<sup>4</sup> (dimensions in mm)**

<sup>4</sup> Generally shielded cable has to be used! Cable versions are delivered with shielded cable. For ISO 4400 the use of shielded cable is compulsory.

<sup>5</sup> tested at 4 bar or 40 mH<sub>2</sub>O for 24 hours

<sup>6</sup> different cable types and lengths available, permissible temperature depends on kind of cable, see cable connection

**Mechanical connection (dimensions in mm)**

standard

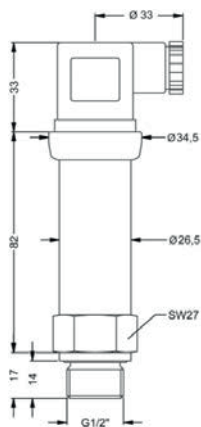

G1/2" DIN 3852

option

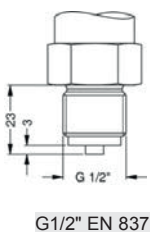

G1/2" EN 837

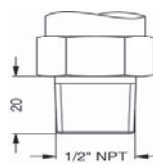

1/2" NPT

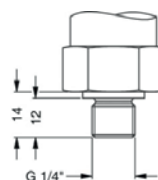

G1/4" DIN 3852

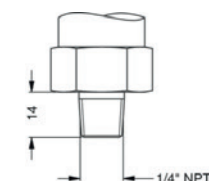

1/4" NPT

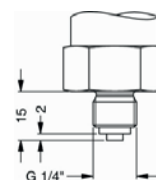

G1/4" EN 837

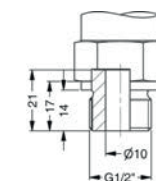

G 1/2" open port  
DIN 3852 (≤ 40 bar)

### DMK 457



Pressure											
	in bar, gauge	5	9	0							
	in bar, absolute	5	9	1							
	in mH <sub>2</sub> O, gauge	5	9	2							
	in mH <sub>2</sub> O, absolute	5	9	3							
Input											
	[mH <sub>2</sub> O]	[bar]									
	4	0.4		4	0	0	0				
	6	0.6		6	0	0	0				
	10	1.0		1	0	0	1				
	16	1.6		1	6	0	1				
	25	2.5		2	5	0	1				
	40	4.0		4	0	0	1				
	60	6.0		6	0	0	1				
	100	10		1	0	0	2				
	160	16		1	6	0	2				
	250	25		2	5	0	2				
	400	40		4	0	0	2				
	600	60		6	0	0	2				
	100	100		1	0	0	3				
	160	160		1	6	0	3				
	250	250		2	5	0	3				
	400	400		4	0	0	3				
	600	600		6	0	0	3				
	-1 ... 0			X	1	0	2				
	customer			9	9	9	9				consult
Output											
	4 ... 20 mA / 2-wire						1				
	Intrinsic safety 4 ... 20 mA / 2-wire						E				
	customer						9				consult
Accuracy											
	0.5 %						5				
	customer						9				consult
Electrical connection											
	Male and female plug ISO 4400 (for cable Ø 4...6 mm)						G 1 0				
	Male and female plug ISO 4400 GL <sup>1,2</sup> (for cable Ø 10...14 mm)						G 0 0				
	Male and female plug ISO 4400 GL <sup>1,2</sup> (for cable Ø 4.5...11 mm)						G 0 1				
	Cable outlet <sup>1,3</sup>						T R 0				
	Field housing stainless steel						8 8 0				
	Submersible version (1.4404 / 316L) with PUR cable <sup>1,3</sup>						T T 1				
	Submersible version (CuNiFe) with PUR cable <sup>1,3</sup>						T S 1				
	customer						9 9 9				consult
Mechanical connection											
	G1/2" DIN 3852						1 0 0				
	G1/2" EN 837						2 0 0				
	G1/4" DIN 3852						3 0 0				
	G1/4" EN 837						4 0 0				
	G1/2" DIN 3852 open pressure port <sup>4</sup>						H 0 0				
	1/2" NPT						N 0 0				
	1/4" NPT						N 4 0				
	customer						9 9 9				consult
Seals											
	FKM						1				
	FFKM <sup>5</sup>						7				
	NBR <sup>5</sup>						5				
	customer						9				consult
Pressure port											
	Stainless steel 1.4404 (316L)						1				
	Copper-Nickel-alloy (CuNi10Fe1Mn) <sup>6</sup>						K				
	customer						9				consult
Diaphragm											
	Ceramics Al <sub>2</sub> O <sub>3</sub> 96%						2				
	customer						9				consult
Special version											
	standard								0	0	0
	oxygen application <sup>7</sup>								0	0	7
	customer								9	9	9

<sup>1</sup> Shielded cable has to be used! Cable versions are delivered with shielded cable.

<sup>2</sup> female plug is GL-approved

<sup>3</sup> different cable types and lengths deliverable, permissible temperature depends on kind of cable

<sup>4</sup> only for P<sub>N</sub> ≤ 40 bar possible

<sup>5</sup> only for P<sub>N</sub> ≤ 100 bar possible

<sup>6</sup> optionally for nominal pressure ranges up to 400 bar and mechanical connections G1/2" DIN 3852, G1/2" EN 837, G1/2" open port,

G1/4" DIN 3852, G1/4" EN837 in combination with housing in CuNi10Fe1Mn

<sup>7</sup> oxygen application with FKM seal possible up to 25 bar

This document contains product specifications; properties are not guaranteed. Detailed information about options are defined in the datasheet. Subject to change without notice.



# DMP 331P

## Industrial Pressure Transmitter

Process Connections With  
Flush Welded Stainless Steel  
Diaphragm

accuracy according to IEC 60770:  
standard: 0.35 % FSO  
option: 0.25 % FSO

### Nominal pressure

from 0 ... 100 mbar up to 0 ... 40 bar

### Output signals

2-wire: 4 ... 20 mA / 3-wire: 0 ... 10 V  
others on request

### Special characteristics

- ▶ hygienic version
- ▶ diaphragm with low surface roughness
- ▶ CIP / SIP cleaning up to 150 °C
- ▶ vacuum resistant

### Optional versions

- ▶ IS-version  
Ex ia = intrinsically safe for gases and dust
- ▶ SIL 2  
according to IEC 61508 / IEC 61511
- ▶ Diaphragm in Hastelloy® or Tantalum
- ▶ cooling element for media temperatures up to 300 °C

The pressure transmitter DMP 331P was designed for use in the food / beverage and pharmaceutical industry. The compact design with hygienic versions makes it possible to achieve an outstanding performance in terms of accuracy, temperature behavior and long term stability.

The modular construction concept allows a combination of various process connections with different filling fluids and a cooling element. Several electrical connections complete the profile of DMP 331P.

### Preferred areas of use are



Food and Beverage



Pharmaceutical Industry

### Material and test certificates

- ▶ inspection certificate 3.1  
according to EN 10204
- ▶ test report 2.2  
according to EN 10204



Input pressure range <sup>1</sup>									
Nominal pressure gauge / abs.	[bar]	-1...0	0.10	0.16	0.25	0.40	0.60	1	1.6
Overpressure	[bar]	5	0.5	1	1	2	5	5	10
Burst pressure ≥	[bar]	7.5	1.5	1.5	1.5	3	7.5	7.5	15
Nominal pressure gauge / abs.	[bar]	2.5	4	6	10	16	25	40	
Overpressure	[bar]	10	20	40	40	80	80	105	
Burst pressure ≥	[bar]	15	25	50	50	120	120	210	
Vacuum resistance		P <sub>N</sub> ≥ 1 bar: unlimited vacuum resistance P <sub>N</sub> ≤ 1 bar: on request							
<sup>1</sup> consider the pressure resistance of fitting and clamps									
Output signal / Supply									
Standard		2-wire: 4 ... 20 mA / V <sub>S</sub> = 8 ... 32 V <sub>DC</sub>							
Option IS-protection		2-wire: 4 ... 20 mA / V <sub>S</sub> = 10 ... 28 V <sub>DC</sub>							
Options 3-wire		3-wire: 0 ... 20 mA / V <sub>S</sub> = 14 ... 30 V <sub>DC</sub> 0 ... 10 V / V <sub>S</sub> = 14 ... 30 V <sub>DC</sub>							
Performance									
Accuracy <sup>2</sup>		standard: nominal pressure < 0.4 bar : ≤ ± 0.5 % FSO nominal pressure ≥ 0.4 bar: ≤ ± 0.35 % FSO option: nominal pressure ≥ 0.4 bar: ≤ ± 0.25 % FSO							
Permissible load		current 2-wire: R <sub>max</sub> = [(V <sub>S</sub> - V <sub>S min</sub> ) / 0.02 A] Ω current 3-wire: R <sub>max</sub> = 500 Ω voltage 3-wire: R <sub>min</sub> = 10 kΩ							
Influence effects		supply: 0.05 % FSO / 10 V				load: 0.05 % FSO / kΩ			
Long term stability		≤ ± 0.1 % FSO / year at reference conditions							
Response time		2-wire: < 10 msec				3-wire: ≤ 3 msec			
<sup>2</sup> accuracy according to IEC 60770 – limit point adjustment (non-linearity, hysteresis, repeatability)									
Thermal effects (Offset and Span) <sup>3</sup> / Permissible temperatures									
Nominal pressure P <sub>N</sub>	[bar]	-1 ... 0			< 0.40			≥ 0.40	
Tolerance band	[% FSO]	≤ ± 0.75			≤ ± 1,5			≤ ± 0.75	
in compensated range	[°C]	-20 ... 85			0 ... 50			-20 ... 85	
Permissible temperatures <sup>4</sup>		medium: -40 ... 125 °C for filling fluid silicon oil -10 ... 125 °C for filling fluid food compatible oil electronics / environment: -40 ... 85 °C storage: -40 ... 100 °C							
Permissible temperature medium for cooling element 300°C		filling fluid silicon oil		overpressure: -40 ... 300 °C		vacuum: -40 ... 150 °C <sup>5</sup>		filling fluid food compatible oil overpressure: -10 ... 250 °C vacuum: -10 ... 150 °C <sup>5</sup>	
<sup>3</sup> an optional cooling element can influence thermal effects for offset and span depending on installation position and filling conditions.									
<sup>4</sup> max. temperature of the medium for nominal pressure gauge > 0 bar: 150 °C for 60 minutes with a max. environmental temperature of 50 °C									
<sup>5</sup> also for P <sub>abs</sub> ≤ 1 bar									
Electrical protection									
Short-circuit protection		permanent							
Reverse polarity protection		no damage, but also no function							
Electromagnetic compatibility		emission and immunity according to EN 61326							
Mechanical stability									
Vibration according to DIN EN 60068-2-6		G 1/2": 20 g RMS (25 ... 2000 Hz)			others: 10 g RMS (25 ... 2000 Hz)				
Shock according to DIN EN 60068-2-27		G 1/2": 500 g / 1 msec			others: 100 g / 1 msec				
Filling fluids									
Standard		silicon oil							
Options		food compatible oil with FDA approval (Mobil DTE FM 32; Category Code: H1; NSF Registration No.: 130662)						others on request	
Materials									
Pressure port		stainless steel 1.4404 (316 L)			others on request				
Housing		stainless steel 1.4404 (316 L)							
Option compact field housing		stainless steel 1.4305 (303), cable gland brass, nickel plated						others on request	
Seals (media wetted)		FKM (recommended for medium temperatures ≤ 200 °C) FFKM (recommended for medium temperatures > 200 °C) Clamp, dairy pipe, Varivent <sup>®</sup> : without							
Standard									
Optional		others on request							
Diaphragm		stainless steel 1.4435 (316 L)							
Standard		Hastelloy <sup>®</sup> C-276 (2.4819)							
Optional		Tantalum on request							
Media wetted parts		pressure port, seal, diaphragm							



<b>Explosion protection (only for 4 ... 20 mA / 2-wire)</b>	
Approvals DX 19-DMP 331P	<b>IBExU 10 ATEX 1068 X / IECEx IBE 12.0027X</b> zone 0: II 1G Ex ia IIC T4 Ga      zone 20: II 1D Ex ia IIIC T 85°C Da
Safety technical maximum values	$U_i = 28 \text{ V}$ , $I_i = 93 \text{ mA}$ , $P_i = 660 \text{ mW}$ , $C_i \approx 0 \text{ nF}$ , $L_i \approx 0 \text{ }\mu\text{H}$ , the supply connections have an inner capacity of max. 27 nF to the housing
Max. temperatures for environment	in zone 0: -20 ... 60 °C with $p_{\text{atm}}$ 0.8 bar up to 1.1 bar in zone 1 or higher: -20 ... 70 °C
Connecting cables (by factory)	cable capacitance: signal line/shield also signal line/signal line: 160 pF/m cable inductance: signal line/shield also signal line/signal line: 1 $\mu\text{H}/\text{m}$
<b>Miscellaneous</b>	
Option SIL <sup>6</sup> 2	according to IEC 61508 / IEC 61511
Current consumption	signal output current: max. 25 mA      signal output voltage: max. 7 mA
Weight	min. 200 g (depending on process connection)
Installation position	any (standard calibration in a vertical position with the pressure port connection down; differing installation position for $P_N \leq 2 \text{ bar}$ have to be specified in the order)
Operational life	> 100 x 10 <sup>6</sup> pressure cycles
CE-conformity	EMC Directive: 2004/108/EC
ATEX Directive	94/4/EG

<sup>6</sup> only for 4 ... 20 mA / 2-wire

### Wiring diagrams

2-wire-system (current)

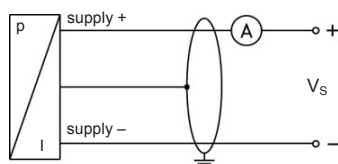

3-wire-system (current / voltage)

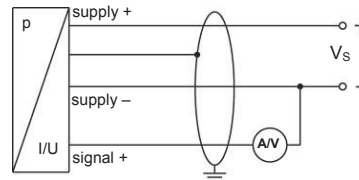

### Pin configuration

Electrical connection	ISO 4400	Binder 723 (5-pin)	M12x1 / metal (4-pin)	field housing	cable colours (DIN 47100)
Supply +	1	3	1	IN +	wh (white)
Supply -	2	4	2	IN -	bn (brown)
Signal (only 3-wire)	3	1	3	OUT+	gn (green)
Shield	ground pin	5	4	⊥	ye/gn (yellow / green)

### Electrical connections (dimensions in mm)

standard

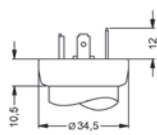

ISO 4400 (IP 65)

option

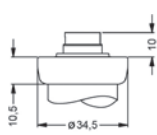

Binder Series 723 (IP 67)

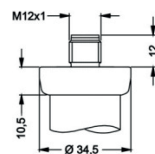

M12x1 4-pin (IP 67)

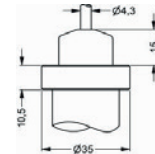

cable outlet with PVC cable (IP 67)<sup>7</sup>

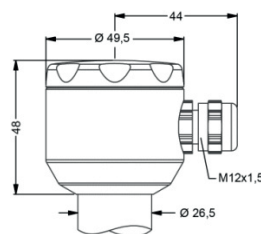

compact field housing (IP 67)

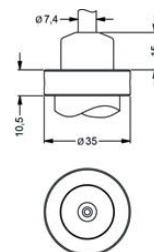

cable outlet, cable with ventilation tube (IP 68)<sup>8</sup>

⇒ universal field housing stainless steel 1.4404 (316 L) with cable gland M20x1.5 (ordering code 880) and other versions on request

<sup>7</sup> standard: 2 m PVC cable without ventilation tube (permissible temperature: -5 ... 70°C)

<sup>8</sup> different cable types and lengths available, permissible temperature depends on kind of cable



### Mechanical connection (dimension in mm)

#### Standard

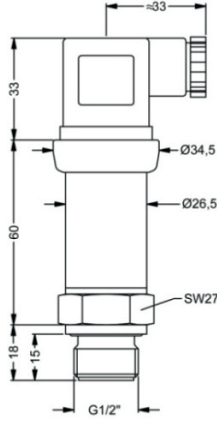

G1/2" flush DIN 3852<sup>9</sup>

#### Option

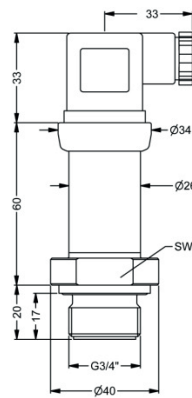

G 3/4" flush DIN 3852 with ISO 4400

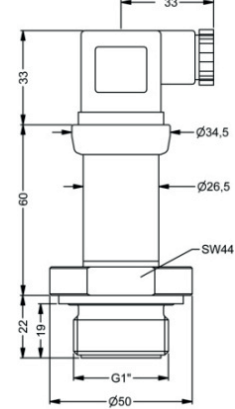

G1" flush DIN 3852 with ISO 4400

#### Option

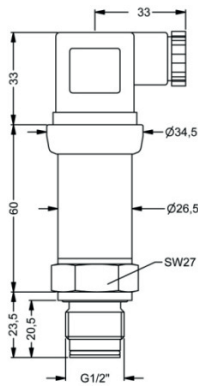

G1/2" flush with radial o-ring<sup>9</sup>

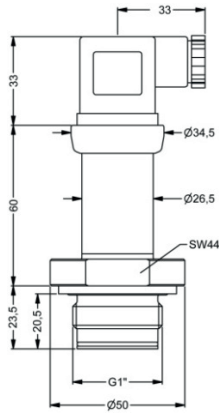

G1" flush with radial o-ring (P<sub>N</sub> ≤ 2 bar)

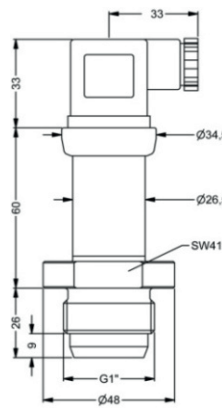

G1" cone with ISO 4400

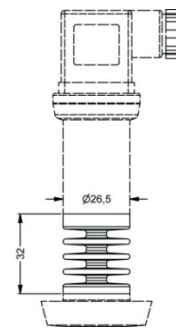

cooling element 300 °C

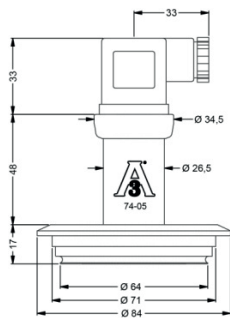

Varivent<sup>®</sup> PN ≤ 25 bar

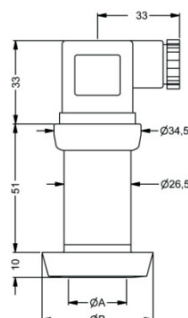

dairy pipe (DIN 11851) with ISO 4400

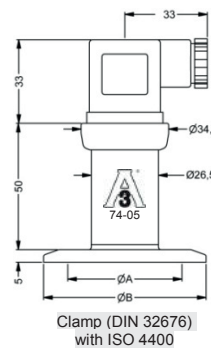

Clamp (DIN 32676) with ISO 4400

dimension in mm			
size	DN 25	DN 40	DN 50
A	23	32	45
B	44	56	68.5
P <sub>N</sub> [bar]	≤ 40	≤ 40	≤ 25

dimension in mm				
size	3/4"	DN 25	DN 32	DN 50
A	14	23	32	45
B	25	50.5	50.5	64
P <sub>N</sub> [bar]	≤ 8	≤ 16	≤ 16	≤ 16

⇒ **SIL- and SIL-Ex version: total length increases by 26.5 mm!**  
 ⇒ **metric threads and other versions on request**

<sup>9</sup> possible only for P<sub>N</sub> ≥ 1 bar

# DMP 331P

## Ordering Code

### DMP 331P



<b>Pressure</b>	gauge	5	0	0															
	absolute	5	0	1															
<b>Input</b>	[bar]																		
	0.10		1	0	0	0													
	0.16		1	6	0	0													
	0.25		2	5	0	0													
	0.40		4	0	0	0													
	0.60		6	0	0	0													
	1.0		1	0	0	1													
	1.6		1	6	0	1													
	2.5		2	5	0	1													
	4.0		4	0	0	1													
	6.0		6	0	0	1													
	10		1	0	0	2													
	16		1	6	0	2													
	25		2	5	0	2													
	40		4	0	0	2													
	-1 ... 0		X	1	0	2													
	customer		9	9	9	9													consult
<b>Output</b>																			
	4 ... 20 mA / 2-wire					1													
	0 ... 20 mA / 3-wire					2													
	0 ... 10 V / 3-wire					3													
	Intrinsic safety 4 ... 20 mA / 2-wire					E													
	SIL2 4 ... 20 mA / 2-wire					1S													
	SIL2 with Intrinsic safety 4 ... 20 mA / 2-wire					ES													
	customer					9													consult
<b>Accuracy</b>																			
	standard for P <sub>N</sub> ≥ 0.4 bar	0.35 %				3													
	standard for P <sub>N</sub> < 0.4 bar	0.5 %				5													
	option for P <sub>N</sub> ≥ 0.4 bar	0.25 %				2													
	customer					9													consult
<b>Electrical connection</b>																			
	Male and female plug ISO 4400					1	0	0											
	Male plug Binder series 723 (5-pin)					2	0	0											
	Cable outlet with PVC-cable <sup>1</sup>					T	A	0											
	Cable outlet <sup>2</sup>					T	R	0											
	Male plug M12x1 (4-pin) / metal					M	1	0											
	Compact field housing stainless steel					8	5	0											
	stainless steel 1.4305 <sup>3</sup>					9	9	9											consult
	customer																		
<b>Mechanical connection</b>																			
	G1/2" with flush welded diaphragm (DIN 3852) <sup>4</sup>					Z	0	0											
	G3/4" with flush welded diaphragm (DIN 3852)					Z	3	0											
	G1" with flush welded diaphragm (DIN 3852)					Z	3	1											
	G1" DIN 3852 with rad. o-ring and flush diaphragm <sup>5</sup>					Z	5	7											
	G1/2" DIN 3852 with rad. o-ring and flush diaphragm <sup>4</sup>					Z	6	1											
	G 1" cone					K	3	1											
	Clamp DN 25 / 1" (DIN 32676) / 3A					C	6	1											
	Clamp DN 32 / 1 1/2" (DIN 32676) / 3A					C	6	2											
	Clamp DN 50 / 2" (DIN 32676) / 3A					C	6	3											
	Clamp 3/4" (DIN 32676) / 3A					C	6	9											
	Dairy pipe DN 25 (DIN 11851) <sup>3</sup>					M	7	3											
	Dairy pipe DN 40 (DIN 11851) <sup>3</sup>					M	7	5											
	Dairy pipe DN 50 (DIN 11851) <sup>3</sup>					M	7	6											
	Varivent <sup>®</sup> DN 40/50 / 3A					P	4	1											
	customer					9	9	9											consult
<b>Diaphragm</b>																			
	Stainless steel 1.4435 (316L)					1													
	Tantalum					T													consult
	Hastello <sup>®</sup> C-276 (2.4819)					H													
	customer					9													consult
<b>Seals</b>																			
	for clamp, dairy pipe, Varivent <sup>®</sup> :	without				0													
	for inch thread - standard:	FKM				1													
	for inch thread - option:	FFKM				7													
	customer					9													consult
<b>Filling Fluids</b>																			
	silicon oil					1													
	food grade oil (FDA) / 3A					2													
	customer					9													consult
<b>Special version</b>																			
	standard						0	0	0										
	with cooling element up to 300°C / 3A						2	0	0										
	customer						9	9	9										consult

<sup>1</sup> standard: 2 m PVC cable without ventilation tube (permissible temperature: -5 ... 70°C), others on request  
<sup>2</sup> cable with ventilation tube (code TR0 = PVC cable), different cable types and lengths available, price without cable  
<sup>3</sup> The cup nut has to be mounted by production of pressure transmitter with electrical connection field housing and mechanical connection dairy pipe.  
The cup nut has to be ordered as separate position.  
<sup>4</sup> possible only for P<sub>N</sub> ≥ 1 bar  
<sup>5</sup> possible only for P<sub>N</sub> ≤ 2 bar  
Varivent<sup>®</sup> is a brand name of GEA Tuuchenagen GmbH, Hastello<sup>®</sup> is a brand name of Haynes International Inc.



# DMK 331P

## Industrial Pressure Transmitter

Pressure Ports With Flush Welded Stainless Steel Diaphragm

accuracy according to IEC 60770:  
0.5 % FSO

### Nominal pressure

from 0 ... 60 bar up to 0 ... 400 bar

### Output signals

2-wire: 4 ... 20 mA

3-wire: 0 ... 20 mA / 0 ... 10 V

others on request

### Special characteristics

- ▶ suited for viscous and pasty media

### Optional versions

- ▶ IS-version  
Ex ia = intrinsically safe for gases and dusts
- ▶ SIL 2  
according to IEC 61508 / IEC 61511
- ▶ food compatible filling fluid with FDA approval
- ▶ cooling element for media temperatures up to 300 °C
- ▶ customer specific versions

The pressure transmitter DMK 331P is suitable for measuring the pressure of viscous and pasty media, where a totally flush pressure port is required.

As on all industrial pressure transmitters made by BD|SENSORS, you may choose between various electrical and mechanical connections also on DMK 331P.

### Preferred areas of use are



Plant and Machine Engineering



Food Industry

### Preferred used for



Viscous and Pasty Media



Input pressure range						
Nominal pressure gauge / abs.	[bar]	60	100	160	250	400
Overpressure	[bar]	100	200	400	400	600
Burst pressure $\geq$	[bar]	120	250	500	500	650
Output signal / Supply						
Standard	2-wire:	4 ... 20 mA / $V_S = 8 \dots 32 V_{DC}$				
Option IS-protection	2-wire:	4 ... 20 mA / $V_S = 10 \dots 28 V_{DC}$				
Options 3-wire	3-wire:	0 ... 20 mA / $V_S = 14 \dots 30 V_{DC}$				
		0 ... 10 V / $V_S = 14 \dots 30 V_{DC}$				
Performance						
Accuracy <sup>1</sup>		$\leq \pm 0.5 \% \text{ FSO}$				
Permissible load	current 2-wire:	$R_{\max} = [(V_S - V_{S \min}) / 0.02 \text{ A}] \Omega$				
	current 3-wire:	$R_{\max} = 500 \Omega$				
	voltage 3-wire:	$R_{\min} = 10 \text{ k}\Omega$				
Influence effects	supply:	0.05 % FSO / 10 V				
	load:	0.05 % FSO / $\text{k}\Omega$				
Long term stability		$\leq \pm 0.3 \% \text{ FSO} / \text{year}$ at reference conditions				
Response time	2-wire:	$\leq 10 \text{ msec}$				
	3-wire:	$\leq 3 \text{ msec}$				
<sup>1</sup> accuracy according to IEC 60770 – limit point adjustment (non-linearity, hysteresis, repeatability)						
Thermal effects (Offset and Span) <sup>2</sup> / Permissible temperatures						
Thermal error		$\leq \pm 0.2 \% \text{ FSO} / 10 \text{ K}$				
in compensated range		-20 ... 85 °C				
Permissible temperatures <sup>3</sup>	medium:	-40 ... 125 °C for filling fluid silicon oil				
		-10 ... 125 °C for filling fluid food compatible oil				
	electronics / environment:	-40 ... 85 °C				
Permissible temperature medium for cooling element 300 °C	filling fluid silicon oil	overpressure:	-40 ... 300 °C	vacuum:	-40 ... 150 °C	
	filling fluid food compatible oil	overpressure:	-10 ... 250 °C	vacuum:	-10 ... 150 °C	
<sup>2</sup> an optional cooling element can influence thermal effects for offset and span depending on installation position and filling conditions.						
<sup>3</sup> max. temperature of the medium for overpressure > 0 bar: 150 °C for 60 minutes with a max. environmental temperature of 50 °C						
Electrical protection						
Short-circuit protection		permanent				
Reverse polarity protection		no damage, but also no function				
Electromagnetic compatibility		emission and immunity according to EN 61326				
Mechanical stability						
Vibration		20 g RMS (25 ... 2000 Hz)	according to DIN EN 60068-2-6			
Shock		500 g / 1 msec	according to DIN EN 60068-2-27			
Filling fluids						
Standard		silicon oil				
Options		food compatible oil (with FDA approval) (Mobil DTE FM 32; Category Code: H1; NSF Registration No.: 130662) others on request				
Materials						
Pressure port		stainless steel 1.4404 (316 L)				
Housing		stainless steel 1.4404 (316 L)				
Option compact field housing		stainless steel 1.4305 (303) with cable gland brass, nickel plated	others on request			
Seals (media wetted)		FKM (recommended for medium temperatures $\leq 200 \text{ }^\circ\text{C}$ ) FFKM (recommended for medium temperatures $> 200 \text{ }^\circ\text{C}$ ) others on request				
Diaphragm		stainless steel 1.4435 (316 L)				
Media wetted parts		pressure port, seals, diaphragm				
Explosion protection (only for 4 ... 20 mA / 2-wire)						
Approvals DX 19 - DMK 331P		<b>IBExU 10 ATEX 1068 X / IECEx IBE 12.0027X</b> zone 0: II 1G Ex ia IIC T4 Ga zone 20: II 1D Ex ia IIC T 85 °C Da, IP65				
Safety technical maximum values		$U_i = 28 \text{ V}$ , $I_i = 93 \text{ mA}$ , $P_i = 660 \text{ mW}$ , $C_i \approx 0 \text{ nF}$ , $L_i \approx 0 \text{ }\mu\text{H}$				
Permissible temperatures for environment	in zone 0:	-20 ... 60 °C with $p_{\text{atm}}$ 0.8 bar up to 1.1 bar				
	in zone 1 or higher:	-20 ... 70 °C				
Connecting cables (by factory)	cable capacitance:	signal line/shield also signal line/signal line: 160 pF/m				
	cable inductance:	signal line/shield also signal line/signal line: 1 $\mu\text{H}/\text{m}$				

Miscellaneous	
Option SIL <sup>4</sup> 2	according to IEC 61508 / IEC 61511
Current consumption	signal output current: max. 25 mA signal output voltage: max. 7 mA
Weight	min. 200 g (depending on process connection)
Installation position	any (standard calibration in a vertical position with the pressure port connection down)
Operational life	> 100 x 10 <sup>6</sup> pressure cycles
CE-conformity	EMC Directive: 2004/108/EC      Pressure Equipment Directive: 97/23/EC (module A) <sup>5</sup>
ATEX Directive	94/4/EG

<sup>4</sup> only for 4 ... 20 mA / 2-wire

<sup>5</sup> This directive is only valid for devices with maximum permissible overpressure > 200 bar

### Wiring diagrams

2-wire-system (current)

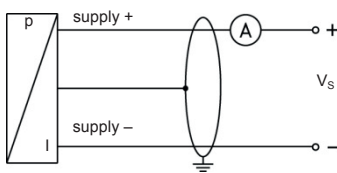

3-wire-system (current / voltage)

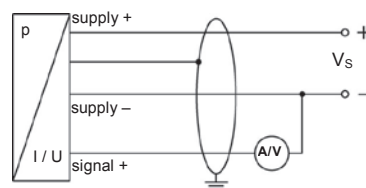

### Pin configuration

Electrical connection	ISO 4400	Binder 723 (5-pin)	M12x1 / metal (4-pin)	field housing	cable colours (DIN 47100)
Supply +	1	3	1	IN +	wh (white)
Supply -	2	4	2	IN -	bn (brown)
Signal + (only for 3-wire)	3	1	3	OUT +	gn (green)
Shield	ground pin	5	4	⊥	ye/gn (yellow / green)

### Electrical connection (dimensions in mm)

standard

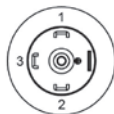
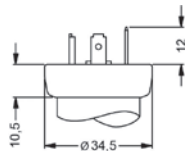

ISO 4400 (IP 65)

option

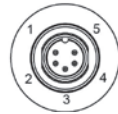
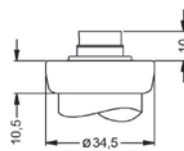

Binder Series 723 5-pin (IP 67)

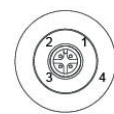
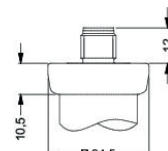

M12x1 4-pin (IP 67)

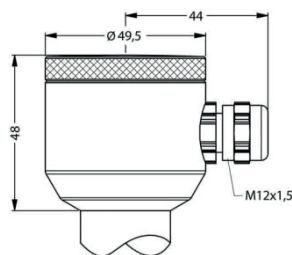

compact field housing (IP 67)

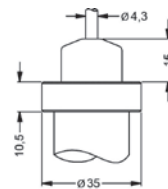

cable outlet with PVC cable (IP 67)<sup>6</sup>

⇒ universal field housing stainless steel 1.4404 (316 L) with cable gland M20x1.5 (ordering code 880) and other versions on request

<sup>6</sup> standard: 2 m PVC cable without ventilation tube (permissible temperature: -5 ... 70°C)

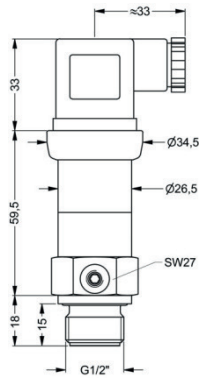
**Mechanical connection (dimensions in mm)**
**standard**

G1/2" flush DIN 3852

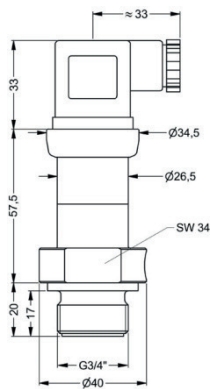
**option**

G3/4" flush DIN 3852

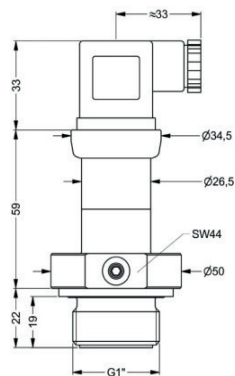

G1" flush DIN 3852

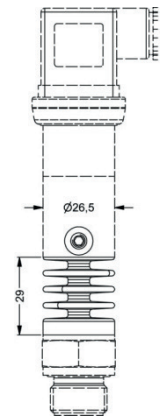
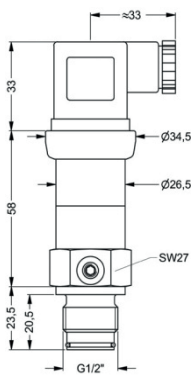
 cooling element  
300 °C

 G1/2" flush  
with radial o-ring

- ⇒ SIL- and SIL-Ex version: total length increases by 26.5 mm!
- ⇒ metric threads and other versions on request

<sup>7</sup> possible for nominal pressure ranges  $P_N \leq 160$  bar

# DMK 331P

## Ordering Code

### DMK 331P



<b>Pressure</b>										
gauge	5	0	5							
absolute	5	0	6							
<b>Input</b>										
[bar]										
60		6	0	0	2					
100		1	0	0	3					
160		1	6	0	3					
250		2	5	0	3					
400		4	0	0	3					
customer		9	9	9	9					consult
<b>Output</b>										
4 ... 20 mA / 2-wire						1				
0 ... 20 mA / 3-wire						2				
0 ... 10 V / 3-wire						3				
Intrinsic safety 4 ... 20 mA / 2-wire						E				
SIL2 4 ... 20 mA / 2-wire						1S				
SIL2 with Intrinsic safety						ES				
4 ... 20 mA / 2-wire										
customer						9				consult
<b>Accuracy</b>										
0.5 %						5				
customer						9				consult
<b>Electrical connection</b>										
Male and female plug ISO 4400						1	0	0		
Male plug Binder series 723 (5-pin)						2	0	0		
Cable outlet with PVC-cable <sup>1</sup>						T	A	0		
Male plug M12x1 (4-pin) / metal						M	1	0		
compact field housing						8	5	0		
stainless steel 1.4305										
customer						9	9	9		consult
<b>Mechanical connection</b>										
G1/2" DIN 3852 with flush diaphragm						Z	0	0		
G3/4" DIN 3852 with flush diaphragm						Z	3	0		
G1" DIN 3852 with flush diaphragm						Z	3	1		
G 1/2" DIN 3852 with rad. o-ring and flush diaphragm						Z	6	1		
customer						9	9	9		consult
<b>Diaphragm</b>										
Stainless steel 1.4435 (316L)						1				
customer						9				consult
<b>Seals</b>										
FKM								1		
FFKM <sup>2</sup>								7		
customer								9		consult
<b>Filling Fluids</b>										
Silicon oil								1		
food compatible oil								2		
customer								9		consult
<b>Special version</b>										
standard								0	0	0
with cooling element up to 300°C <sup>3</sup>								2	0	0
customer								9	9	9
										consult

<sup>1</sup> standard: 2 m PVC cable without ventilation tube (permissible temperature: -5 ... 70°C)

<sup>2</sup> only for P<sub>N</sub> ≤ 100 bar possible

<sup>3</sup> only for P<sub>N</sub> ≤ 160 bar possible



# DMK 351P

## Pressure Transmitter for the Process Industry

Ceramic Sensor

accuracy according to IEC 60770:  
Standard: 0.35 % FSO  
Option: 0.25 % FSO

### Nominal pressure

from 0 ... 40 mbar up to 0 ... 20 bar

### Output signal

2-wire: 4 ... 20 mA  
3-wire: 0 ... 10 V  
others on request

### Special characteristics

- ▶ hygienic version
- ▶ different process connections (G1 1/2", diary pipe, clamp, etc.)
- ▶ high overpressure capability



### Optional versions

- ▶ IS-version  
Ex ia = intrinsically safe for gases and dusts
- ▶ diaphragm 99.9 % Al<sub>2</sub>O<sub>3</sub>
- ▶ customer specific versions  
e.g. special pressure ranges



The pressure transmitter DMK 351P has been designed for measuring small system pressure in the food industry and chemical industry.

The DMK 351P is based on an own-developed capacitive ceramic sensor element. It features high overpressure resistance and high resistance against most of aggressive media. A variety of different process and electrical connections and an intrinsically safe version complete the range of possibilities.

### Preferred areas of use are

-  Food Industry
-  Chemical and Petrochemical Industry

### Preferred used for

-  Paint and Varnish
-  Viscous and Pasty Media





Pressure ranges																		
Nominal pressure gauge [bar]	0.04	0.06	0.1	0.16	0.25	0.4	0.6	1	1.6	2.5	4	6	10	16	20			
Nominal pressure absolut [bar]	on request								0.4	0.6	1	1.6	2.5	4	6	10	16	20
Overpressure [bar]	2	2	4	4	6	6	8	8	15	25	25	35	35	45	45			
Permissible vacuum [bar]	-0.2		-0.3		-0.5				-1									

Output signal / Supply	
Standard	2-wire: 4 ... 20 mA / $V_S = 9 \dots 32 V_{DC}$
Option IS-protection	2-wire: 4 ... 20 mA / $V_S = 14 \dots 28 V_{DC}$
Option 3-wire	3-wire: 0 ... 10 V / $V_S = 12.5 \dots 32 V_{DC}$

Performance	
Accuracy <sup>1</sup>	
Standard	$\leq \pm 0.35 \% \text{ FSO}$
Option	$\leq \pm 0.25 \% \text{ FSO}$
Long term stability	$\leq \pm 0.1 \% \text{ FSO} / \text{year}$
Influence effects	supply: 0.05 % FSO / 10 V load: 0.05 % FSO / k $\Omega$
Permissible load	current 2-wire: $R_{\max} = [(V_S - V_{S \min}) / 0.02 \text{ A}] \Omega$ voltage 3-wire: $R_{\min} = 10 \text{ k}\Omega$
Turn-on time	700 msec
Mean measuring rate	5 / sec
Response time	mean response time: $\leq 200 \text{ msec}$ max. response time: 380 msec

<sup>1</sup> accuracy according to IEC 60770 - limit point adjustment (non-linearity, hysteresis, repeatability)

Thermal errors (offset and span) / -Permissible temperatures	
Thermal error	$\leq \pm 0.1 \% \text{ FSO} / 10 \text{ K}$ in compensated range - 20 ... 80°C
Permissible temperatures	medium: -40 ... 125 °C electronics / environment: -40 ... 85 °C storage: -40 ... 100 °C

Electrical protection	
Short-circuit protection	permanent
Reverse polarity protection	no damage, but also no function
Electromagnetic compatibility	emission and immunity according to EN 61326

Mechanical stability	
Vibration	10 g RMS (20 ... 2000 Hz) according to DIN EN 60068-2-6
Shock	100 g / 1 msec according to DIN EN 60068-2-27

Materials	
Pressure port	stainless steel 1.4404
Housing	
Standard	stainless steel 1.4404
compact field housing	stainless steel 1.4435
Seal (media wetted)	FKM EPDM others on request
Diaphragm	
Standard	ceramic Al <sub>2</sub> O <sub>3</sub> 96 %
Option	ceramic Al <sub>2</sub> O <sub>3</sub> 99.9 %
Media wetted parts	pressure port, seals, diaphragm

IS-protection (only for 4 ... 20 mA / 2-wire)	
Approval DX 14-DMK 351 P	male (connector)-version: zone 0: II 1 G Ex ia IIC T4 zone 20: II 1 D Ex IP6X T=85°C cable-version: zone 0: II 1 G EEx ia IIB T4 zone 20: II 1 D EEx IP6X T=85°C
Safety technical maximum values	$U_i = 28 \text{ V}$ , $I_i = 93 \text{ mA}$ , $P_i = 660 \text{ mW}$ , $C_i = 27 \text{ nF}$ , $L_i = 5 \mu\text{H}$
Max. permissible temperature for environment	zone 0: -20 ... 60 °C for $p_{\text{atm}}$ 0.8 bar up to 1.1 bar zone 1: -25 ... 70 °C
Connecting cables (by factory)	capacity: signal line / shield also signal line / signal line: 160 pF/m inductance: signal line / shield also signal line / signal line: 1 $\mu\text{H}/\text{m}$

Miscellaneous	
Current consumption	max. 21 mA
Weight	min. 200 g
Installation position	any
Operational life	$> 100 \times 10^6$ loading cycles
CE-conformity	EMC-directive: 2004/108/EC

**Wiring diagram**

2-wire-system (current)

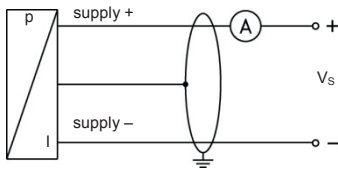

3-wire-system (current / voltage)

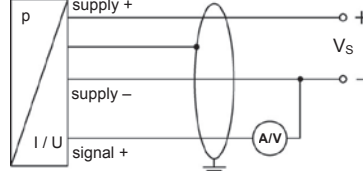
**Pin configuration**

Electrical connection	ISO 4400	Binder 723 (5-pin)	M12x1 (4-pin)	field housing	cable colour (DIN 47100)
Supply +	1	3	1	IN +	wh (white)
Supply -	2	4	2	IN -	bn (brown)
Signal + (only 3-wire)	3	1	3	OUT +	gn (green)
Shield	ground pin	5	4	⊥	ye/gn (yellow / green)

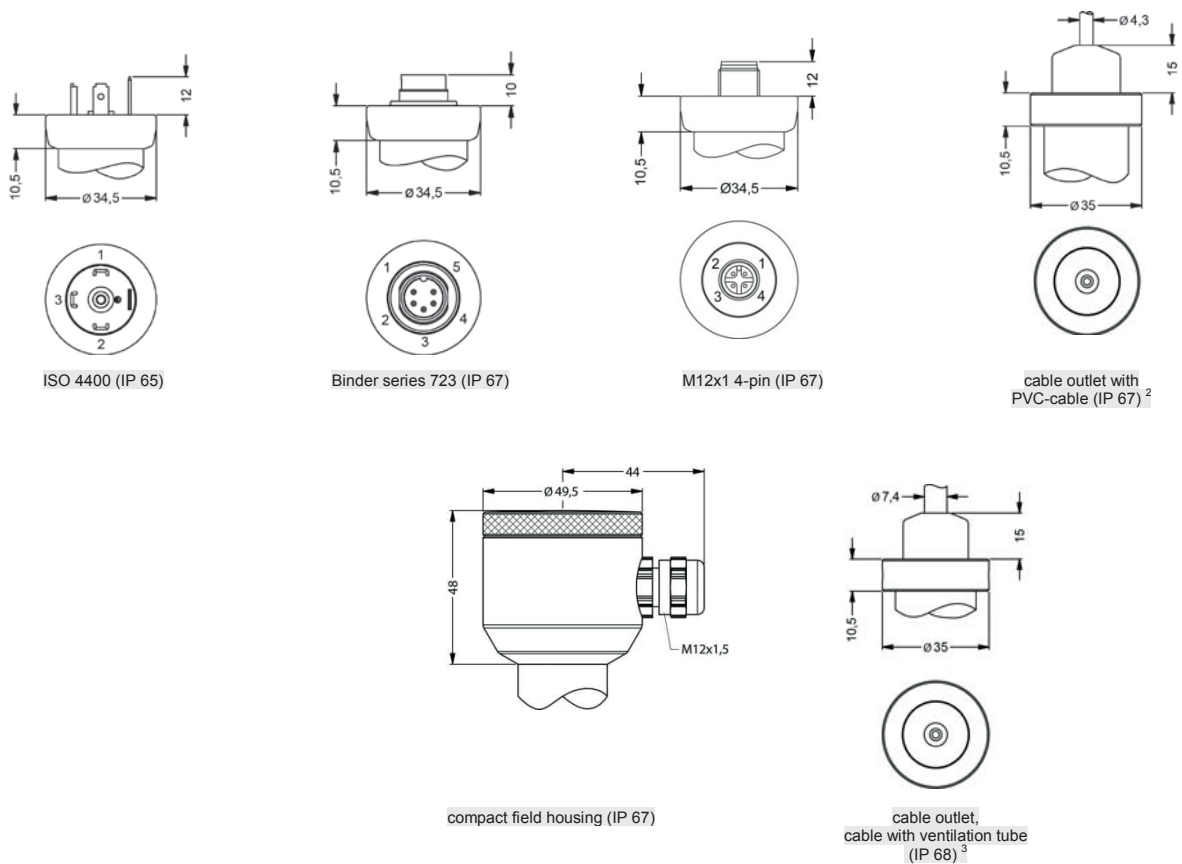
**Electrical connections (dimensions in mm)**

⇒ universal stainless steel field housing 1.4404 with cable gland M20x1.5 (ordering code 880) and other versions on request

<sup>2</sup> standard: 2 m PVC-cable without ventilation tube (permissible temperature: -5 ... 70 °C)

<sup>3</sup> different cable types and lengths available, permissible temperature depends on kind of cable

### Dimensions (in mm)

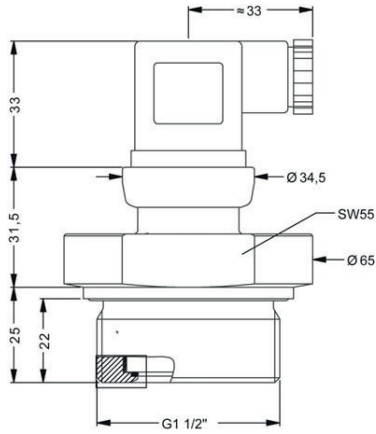

G1 1/2" EN 837

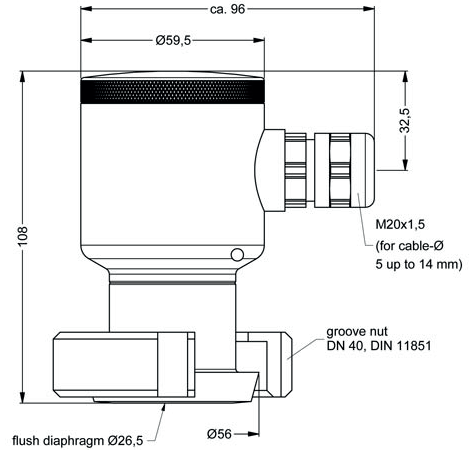
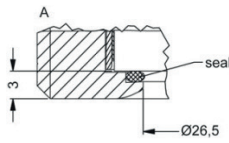

field housing  
with dairy pipe (DIN 11851)

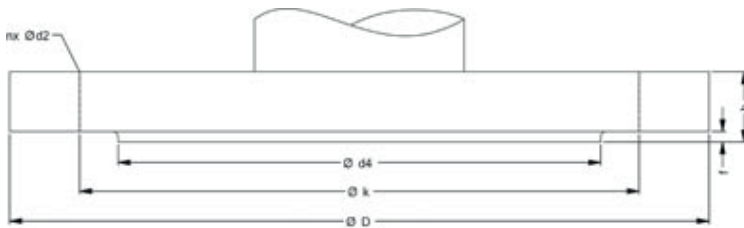

flange (DIN 2501)

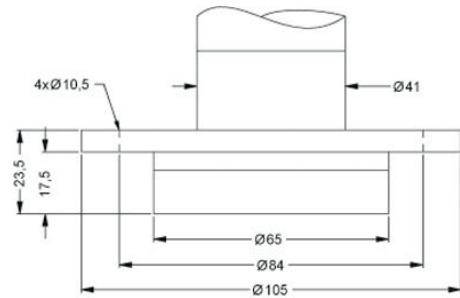

flange DRD<sup>4</sup>

dimensions in mm			
size	DN25	DN50	DN80
D	115	165	200
k	85	125	160
d4	68	102	138
b	18	20	20
f	2	3	3
n	4	4	8
d2	14	18	18
P <sub>N</sub> [bar]	≤ 40	≤ 40	≤ 16

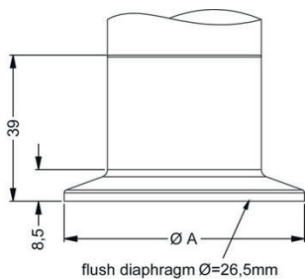

Clamp (DIN 32676)

dimensions in mm		
size	DN32	DN50
A	50,5	64
P <sub>N</sub> [bar]	≤ 16	≤ 16

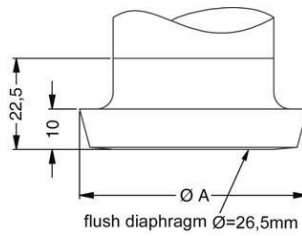

dairy pipe (DIN 11851)

dimensions in mm			
size	DN25	DN40	DN50
A	44	56	68,5

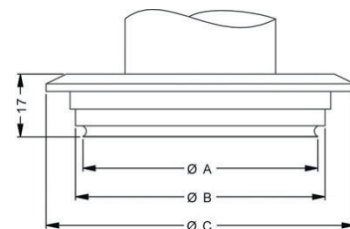

Varivent

dimensions in mm		
size	P41	P63
A	64	91
B	68	96,5
C	84	113

<sup>4</sup> mounting flange is included in the delivery (already pre-assembled)

# DMK 351P

## Ordering Code

### DMK 351P



Pressure																			
	gauge	2	9	5															
	absolute <sup>1</sup>	2	9	6															
Input		[mH <sub>2</sub> O]	[bar]																
	0.4	0.04		0	4	0	0												
	0.6	0.06		0	6	0	0												
	1.0	0.10		1	0	0	0												
	1.6	0.16		1	6	0	0												
	2.5	0.25		2	5	0	0												
	4.0	0.40		4	0	0	0												
	6.0	0.60		6	0	0	0												
	10	1.0		1	0	0	1												
	16	1.6		1	6	0	1												
	25	2.5		2	5	0	1												
	40	4.0		4	0	0	1												
	60	6.0		6	0	0	1												
	100	10		1	0	0	2												
	160	16		1	6	0	2												
	200	20		2	0	0	2												
	customer			9	9	9	9												consult
Output																			
	4 ... 20 mA / 2-wire							1											
	0 ... 10 V / 3-wire							3											consult
	Intrinsic safety 4 ... 20 mA / 2-wire							E											
	customer							9											consult
Accuracy																			
	standard	0.35 %						3											
	option	0.25 %						2											
	customer							9											consult
Electrical connection																			
	Male and female plug ISO 4400							1	0	0									
	Cable outlet with PVC cable <sup>2</sup>							T	A	0									
	Binder series 723							2	0	0									
	Compact field housing							8	5	0									
	Cable outlet							T	R	0									
	Male plug M12x1 (4-pin) / metal							M	1	0									
	customer							9	9	9									consult
Mechanical connection																			
	G 1 1/2" DIN flush (DIN 3852)							M	0	0									
	Clamp DN 32 (DIN 32676)							C	6	2									
	Clamp DN 50 (DIN 32676)							C	6	3									
	Dairy pipe DN 40 (DIN 11851) <sup>3</sup>							M	7	5									
	Dairy pipe DN 50 (DIN 11851) <sup>3</sup>							M	7	6									
	Varivent <sup>®</sup> DN 40/50							P	4	1									consult
	Flange DN 25 / PN 40 (DIN 2501)							F	2	0									consult
	Flange DN 50 / PN 40 (DIN 2501)							F	2	3									consult
	Flange DN 80 / PN 16 (DIN 2501)							F	1	4									consult
	customer							9	9	9									consult
Seals																			
	FKM									1									
	EPDM									3									
	customer									9									consult
Pressure port																			
	Stainless steel 1.4404 (316L)									1									
	customer									9									consult
Diaphragm																			
	Ceramics Al <sub>2</sub> O <sub>3</sub> 96 %									2									
	Ceramics Al <sub>2</sub> O <sub>3</sub> 99.9 %									C									
	customer									9									consult
Special version																			
	standard																		0 0 0
	customer																		9 9 9
																			consult

<sup>1</sup> absolute pressure from 0.04 bar up to 0.25 bar on request

<sup>2</sup> standard: 2 m PVC cable without ventilation tube

<sup>3</sup> The cup nut has to be mounted by production of pressure transmitter with electrical connection field housing and mechanical connection dairy pipe.

The cup nut has to be ordered as separate position.

Varivent<sup>®</sup> is a brand name of GEA Tuchenhausen GmbH



# 18.600 G

## OEM Pressure Transmitter Pneumatics

### Applications

- ▶ compressed air network
- ▶ general mechanical engineering

### Characteristics

- ▶ silicon sensor without media isolation
- ▶ accuracy 0.5 % FSO according to IEC 60770
- ▶ nominal pressure ranges from 0 ... 100 mbar up to 0 ... 6 bar



### Technical Data

Input pressure range											
Nominal pressure gauge	[bar]	-1 ... 0	0.1	0.25	0.4	0.6	1	1.6	2.5	4	6
Overpressure	[bar]	3	0.5	1	1	3	3	6	10	10	20

Output signal / Supply	
Standard	2-wire: 4 ... 20 mA / $V_S = 8 \dots 32 V_{DC}$
Option	3-wire: 0 ... 10 V / $V_S = 14 \dots 30 V_{DC}$
	3-wire ratiometric: 0.5 ... 4.5 V / $V_S = 5 \pm 0.5 V_{DC}$

Performance	
Accuracy <sup>1</sup>	$\leq \pm 0.5 \% \text{ FSO}$
Permissible load	2-wire: $R_{max} = [(V_S - V_{Smin}) / 0.02 A] \Omega$ 3-wire: $R_{min} = 10 k\Omega$
Influence effects	supply: 0.05 % FSO / 10 V load: 0.05 % FSO / k $\Omega$
Response time	2-wire: $\leq 10 \text{ msec}$ 3-wire: $\leq 3 \text{ msec}$
Measuring rate	1 kHz

<sup>1</sup> accuracy according to IEC 60770 – limit point adjustment (non-linearity, hysteresis, repeatability)

Thermal effects (Offset and Span)			
Nominal pressure $P_N$	[bar]	-1 ... 0	$\leq 0.4$ > 0.4
Tolerance band	[% FSO]	$\leq \pm 1$	$\leq \pm 1$ $\leq \pm 0.75$
in compensated range	[°C]	0 ... 70	-20 ... 85

Permissible temperatures			
Permissible temperatures	medium: -25 ... 125 °C	electronics / environment: -25 ... 85 °C	storage: -40 ... 85 °C

Electrical protection	
Short-circuit protection	permanent
Reverse polarity protection	no damage, but also no function
Electromagnetic compatibility	emission and immunity according to EN 61326

Mechanical stability		
Vibration	10 g, 25 Hz ... 2 kHz	according to DIN EN 60068-2-6
Shock	100 g / 11 msec	according to DIN EN 60068-2-27

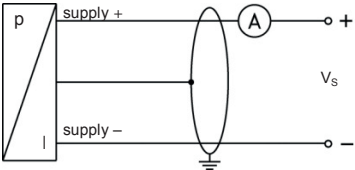
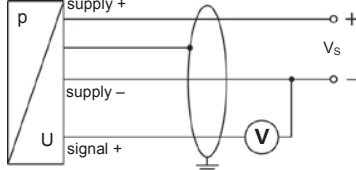
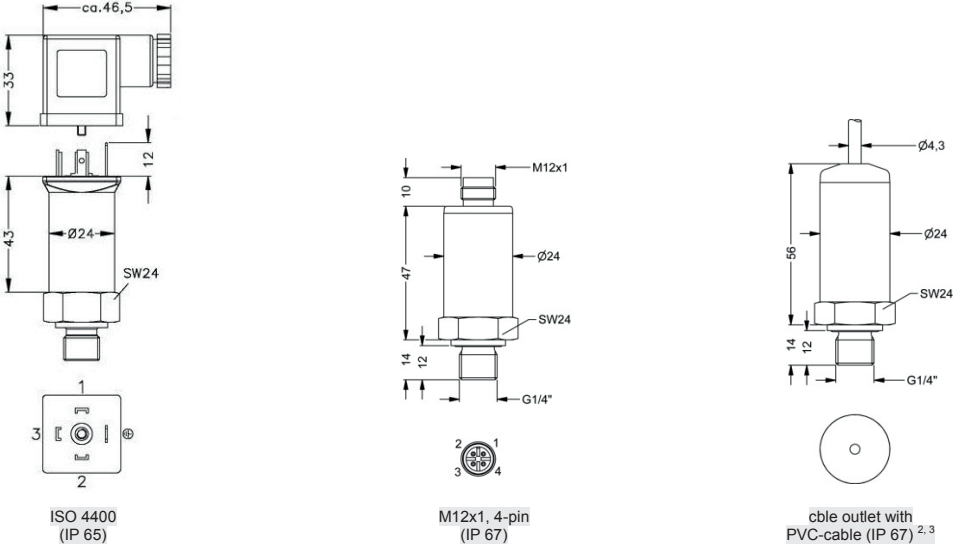
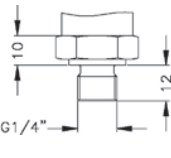
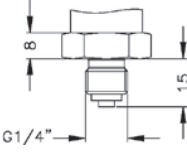
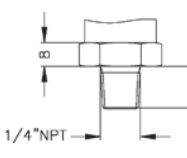
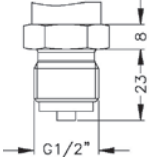
<b>Materials</b>			
Pressure port / housing	stainless steel 1.4301 (304)		
Seals	FKM		
Sensor	stainless steel 1.4404 (316L), silicon, glass, epoxy or RTV		
Media wetted parts	pressure port, seals, sensor		
<b>Miscellaneous</b>			
Permissible media	pressurized air, non-aggressive gases		
Current consumption	2-wire: max. 25 mA 3-wire voltage: max. 7 mA (short circuit current: max. 20 mA)		
CE-conformity	EMC Directive: 2004/108/EC		
<b>Wiring diagrams</b>			
2-wire-system (current) 		3-wire-system (voltage) 	
<b>Pin configuration</b>			
Electrical connections	ISO 4400	M12x1 (4-pin)	cable colours (DIN 47100)
Supply +	1	1	wh (white)
Supply -	2	2	bn (brown)
Signal + (for 3-wire)	3	3	gn (green)
Shield	ground pin	4	ye/gn (yellow / green)
<b>Electrical connections (dimensions in mm)</b>			
			
<sup>2</sup> standard: 2 m PVC cable without ventilation tube (permissible temperatur: -5 ... 70 °C) <sup>3</sup> different cable types and lengths available, permissible temperatur depends on kind of cable			
<b>Mechanical connection (dimensions in mm)</b>			
<b>standard</b>		<b>option <sup>4</sup></b>	
			
G1/4" DIN 3852		G1/4" EN 837	
			
G1/4" NPT		G1/2" EN 837	
<sup>4</sup> other mechanical connections on request			





# 18.601 G

## OEM Pressure Transmitter Low Pressure

### Applications

- ▶ general industrial applications

### Characteristics

- ▶ piezoresistive stainless steel sensor
- ▶ accuracy 0.5 % FSO according to IEC 60770
- ▶ nominal pressure ranges from 0 ... 100 mbar up to 0 ... 6 bar



### Technical Data

Input pressure range											
Nominal pressure gauge	[bar]	0.1	0.16	0.25	0.4	0.6	1	1.6	2.5	4	6
Overpressure	[bar]	1	1	1	1	3	3	6	10	10	21
Burst pressure ≥	[bar]	1.5	1.5	1.5	1.5	5	5	10	17.5	17.5	35
Vacuum resistance		unlimited									
Output signal / Supply											
Standard	2-wire:	4 ... 20 mA / V <sub>S</sub> = 8 ... 32 V <sub>DC</sub>									
Options 3-wire	3-wire:	0 ... 10 V / V <sub>S</sub> = 14 ... 30 V <sub>DC</sub>									
	3-wire ratiometric:	V <sub>Sig</sub> = 0.5 ... 4.5 V / V <sub>S</sub> = 5 ± 0.5 V <sub>DC</sub>									
Performance											
Accuracy <sup>1,2</sup>		≤ ± 0.5 % FSO									
Permissible load	2-wire:	R <sub>max</sub> = [(V <sub>S</sub> - V <sub>S min</sub> ) / 0.02 A] Ω									
	3-wire:	R <sub>min</sub> = 10 kΩ									
Influence effects	supply:	0.05 % FSO / 10 V									
	load:	0.05 % FSO / kΩ									
Response time	2-wire:	≤ 10 msec					3-wire: ≤ 3 msec				
Measuring rate		1 kHz									
<sup>1</sup> accuracy according to IEC 60770 – limit point adjustment (non-linearity, hysteresis, repeatability)											
<sup>2</sup> for pressure ranges ≤ 160 mbar accuracy is ≤ ± 1% FSO											
Thermal effects (Offset and Span) / Permissible temperatures											
Thermal error		≤ ± 0.3 % FSO / 10 K					in compensated range 0 ... 70 °C				
Permissible temperatures		Medium: -25 ... 125 °C			electronics / environment: -25 ... 85 °C			storage: -40 ... 85 °C			
Electrical protection											
Short-circuit protection		permanent					3-wire ratiometric: none				
Reverse polarity protection		no damage, but also no function									
Electromagnetic compatibility		emission and immunity according to EN 61326									
Mechanical stability											
Vibration		10 g, 25 Hz ... 2 kHz					according to DIN EN 60068-2-6				
Shock		100 g / 1 msec					according to DIN EN 60068-2-27				



<b>Materials</b>	
Pressure port / housing	stainless steel 1.4301 (304)
Seals	FKM
Diaphragm	stainless steel 1.4435 (316 L)
Media wetted parts	pressure port, seals, diaphragm
<b>Miscellaneous</b>	
Weight	approx. 120 g
Current consumption	2-wire: max. 25 mA 3-wire ratiometric: typ. 1.5 mA 3-wire voltage: max. 7 mA (short circuit current: max. 20 mA)
CE-conformity	EMC Directive: 2004/108/EC

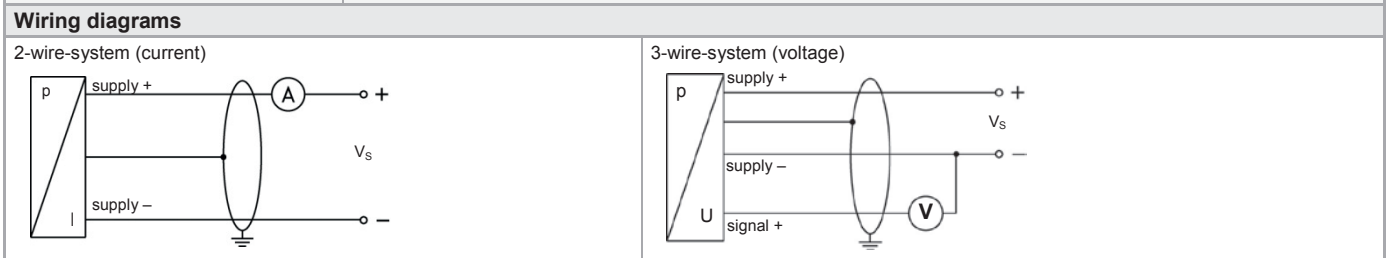

**Pin configuration**

Electrical connection	ISO 4400	M12x1 (4-pin)	cable colours (DIN 47100)
Supply +	1	1	wh (white)
Supply -	2	2	bn (brown)
Signal + (for 3-wire)	3	3	gn (green)
Shield	ground pin	4	ye/gn (yellow / green)

**Electrical connections (dimensions in mm)**

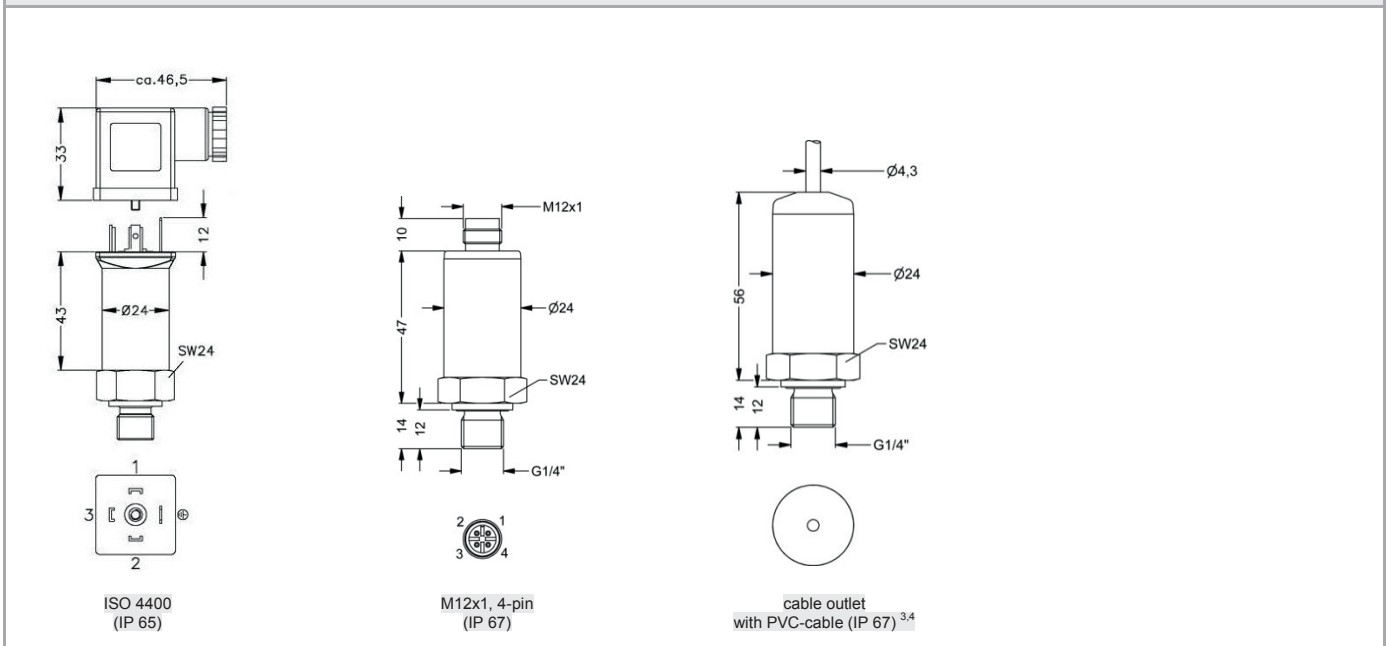

<sup>3</sup> standard: 2 m PVC cable without ventilation tube (permissible temperature: -5 ... 70 °C)  
<sup>4</sup> different cable types and lengths available, permissible temperature depends on kind of cable

**Mechanical connection (dimensions in mm)**

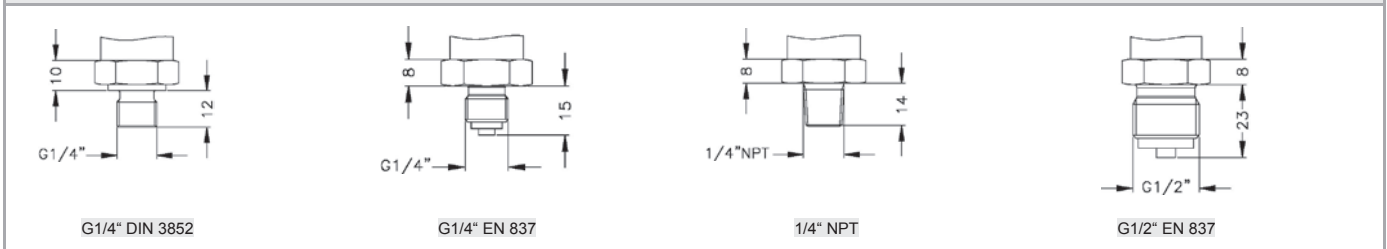

This document contains product specifications; properties are not guaranteed. Subject to change without notice.





# 26.600 G

## OEM Pressure Transmitter Standard

### Applications

- ▶ mechanical and plant engineering
- ▶ general industrial applications

### Characteristics

- ▶ ceramic sensor
- ▶ accuracy 0.5 % FSO according to IEC 60770
- ▶ nominal pressure ranges from 0 ... 1 bar up to 0 ... 400 bar
- ▶ option: oil and grease free version

### Technical Data



Input pressure range		-1...0 <sup>1</sup>	1	1.6	2.5	4	6	10	16	25	40	60	100	160	250	400
Nominal pressure gauge [bar]		-	1	1.6	2.5	4	6	10	16	25	40	60	100	160	250	400
Nominal pressure abs. [bar]		-	1	1.6	2.5	4	6	10	16	25	40	60	100	160	250	400
Overpressure [bar]		3	3	5	5	12	12	20	50	50	120	120	200	400	400	650
Burst pressure ≥ [bar]		4	4	7	7	15	15	25	70	70	150	150	250	500	500	700
Vacuum resistance		unlimited														

<sup>1</sup> for this pressure range accuracy is ≤ 1 % FSO IEC 60770

Output signal / Supply	
Standard	2-wire: 4 ... 20 mA / V <sub>S</sub> = 8 ... 32 V <sub>DC</sub>
Options	3-wire: 0 ... 10 V / V <sub>S</sub> = 14 ... 30 V <sub>DC</sub>
	3-wire ratiometric: V <sub>Sig</sub> = 0.5 ... 4.5 V / V <sub>S</sub> = 5 ± 0.5 V <sub>DC</sub>

Performance	
Accuracy <sup>2</sup>	≤ ± 0.5 % FSO
Permissible load	2-wire: R <sub>max</sub> = [(V <sub>S</sub> - V <sub>Smin</sub> ) / 0.02 A] Ω      3-wire: R <sub>min</sub> = 10 kΩ
Influence effects	supply: 0.05 % FSO / 10 V      load: 0.05 % FSO / kΩ
Response time	2-wire: ≤ 10 msec      3-wire: ≤ 3 msec
Measuring rate	1 kHz

<sup>2</sup> accuracy according to IEC 60770 – limit point adjustment (non-linearity, hysteresis, repeatability)

Thermal effects (Offset and Span) / Permissible temperatures	
Thermal error	≤ ± 0.3 % FSO / 10 K      in compensated range: -25 ... 85 °C
Permissible temperatures	medium: -25 ... 125 °C      electronics / environment: -25 ... 85 °C      storage: -40 ... 85 °C

Electrical protection	
Short-circuit protection	permanent      3-wire ratiometric: none
Reverse polarity protection	no damage, but also no function
Electromagnetic protection	emission and immunity according to EN 61326

Mechanical stability	
Vibration	10 g, 25 Hz ... 2 kHz      according to DIN EN 60068-2-6
Shock	500 g / 1 msec      according to DIN EN 60068-2-27

Materials	
Pressure port / housing	stainless steel 1.4301 (304)
Seals (media wetted)	FKM others on request
Diaphragm	ceramics Al <sub>2</sub> O <sub>3</sub> 96 %
Media wetted parts	pressure port, seals, diaphragm
Miscellaneous	
Option oxygen application	for P <sub>N</sub> ≤ 15 bar: O-ring in 70 EPDM 281 (with BAM-approval); permissible maximum values are 15 bar / 60° C and 10 bar / 90° C for P <sub>N</sub> ≤ 25 bar: O-ring in FKM Vi 567 (with BAM-approval); permissible maximum values are 25 bar / 150° C
Weight	approx. 120 g
Current consumption	2-wire: max. 25 mA 3-wire ratiometric: typ. 1.5 mA 3-wire voltage: max. 7 mA (short circuit current: max. 20 mA)
Long term stability	≤ ± 0.3 % FSO / year at reference conditions
Operational life	> 100 x 10 <sup>6</sup> cycles
CE-conformity	EMC Directive: 2004/108/EC Pressure Equipment Directive: 97/23/EC (module A) <sup>3</sup>

<sup>3</sup> This directive is only valid for devices with maximum permissible overpressure > 200 bar

### Wiring diagrams

#### 2-wire-system (current)

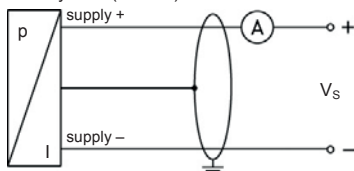

#### 3-wire-system (voltage)

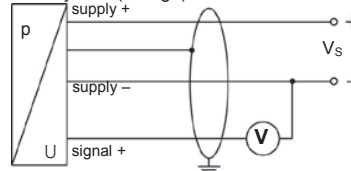

### Pin configuration

Electrical connection	ISO 4400	Micro (contact distance 9.4 mm)	M12x1 (4-pin), plastic	cable colours (DIN 47100)
Supply +	1	1	1	wh (white)
Supply -	2	2	2	bn (brown)
Signal + (for 3-wire)	3	3	3	gn (green)
Shield	ground pin	ground pin	4	ye/gn (yellow / green)

### Electrical connections (dimensions in mm)

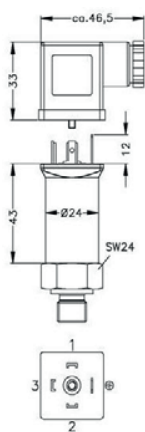

ISO 4400  
(IP 65)

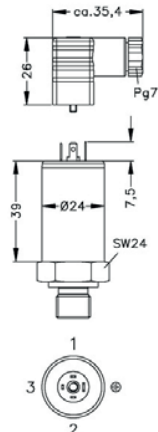

Micro, contact  
distance 9.4 mm (IP 65)

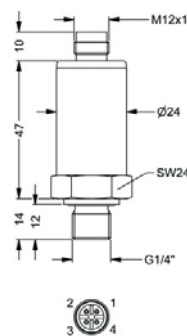

M12x1, 4-pin  
(IP 67)

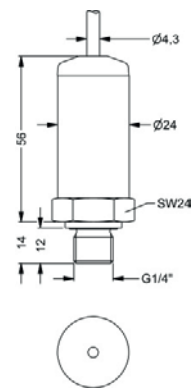

cable outlet with  
PVC-cable (IP 67)<sup>4,5</sup>

\* pressure range P<sub>N</sub> = 400 bar: total length increases by 12 mm.

<sup>4</sup> standard: 2 m PVC cable without ventilation tube (permissible temperature: -5 ... 70 °C)

<sup>5</sup> different cable types and lengths available, permissible temperature depends on kind of cable

### Mechanical connection (dimensions in mm)

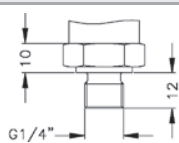

G1/4" DIN 3852

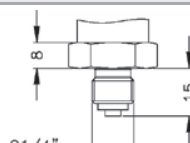

G1/4" EN 837

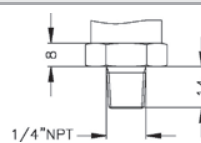

1/4" NPT



G1/2" EN 837

26.600 G - [ ] - [ ] - [ ] - [ ] - [ ] - [ ] - [ ] - [ ] - [ ] - [ ] - [ ]

<b>Input</b>	[bar]																		
	1.0	1	0	0	1														
	1.6	1	6	0	1														
	2.5	2	5	0	1														
	4.0	4	0	0	1														
	6.0	6	0	0	1														
	10	1	0	0	2														
	16	1	6	0	2														
	25	2	5	0	2														
	40	4	0	0	2														
	60	6	0	0	2														
	100	1	0	0	3														
	160	1	6	0	3														
	250	2	5	0	3														
	400	4	0	0	3														
	-1 ... 0 <sup>1</sup>	X	1	0	2														
	customer	9	9	9	9														consult
<b>Pressure</b>																			
	gauge						R												
	absolute						A												
<b>Output</b>																			
	4 ... 20 mA / 2-wire						1												
	0 ... 10 V / 3-wire						3												
	0.5 ... 4.5 V / 3-wire ratiometric						R												
	customer						9												consult
<b>Accuracy</b>																			
	0.5 % FSO						5												
	customer						9												consult
<b>Electrical connection</b>																			
	Male and female plug ISO 4400						1	0	0										
	Male and female plug Micro						C	1	0										
	Male plug M12x1 (4-pin), plastic						M	0	0										
	Cable outlet with PVC cable <sup>2</sup>						T	A	0										
	customer						9	9	9										consult
<b>Mechanical connection</b>																			
	G1/4" DIN 3852								3	0	0								
	G1/4" EN 837								4	0	0								
	1/4" NPT								N	4	0								
	G1/2" EN 837								2	0	0								
	customer								9	9	9								consult
<b>Seal</b>																			
	FKM										1								
	EPDM										3								
	customer										9								consult
<b>Special version</b>																			
	standard										0	0	0						
	oxygen application <sup>3</sup>										0	0	7						
	oil and grease free										0	0	8						
	customer										9	9	9						consult

**Prices EXW Thierstein, excluding package**

<sup>1</sup> for nominal pressure range -1 ... 0 bar accuracy is 1 % FSO  
<sup>2</sup> standard: 2 m PVC cable without ventilation tube (permissible temperature: -5 ... 70 °C)  
<sup>3</sup> oxygen application with FKM seal up to 25 bar or with EPDM seal up to 15 bar possible



# 30.600 G

## OEM Pressure Transmitter Low Cost

**Applications**

- ▶ mechanical and plant engineering
- ▶ general industrial applications

**Characteristics**

- ▶ ceramic sensor
- ▶ accuracy 1 % FSO according to IEC 60770
- ▶ nominal pressure ranges from 0 ... 1.6 bar up to 0 ... 250 bar

Technical Data



Input pressure range													
Nominal pressure gauge	[bar]	1.6	2.5	4	6	10	16	25	40	60	100	160	250
Overpressure	[bar]	5	5	12	12	20	50	50	120	120	200	400	400
Burst pressure ≥	[bar]	7	7	15	15	25	70	70	150	150	250	500	500
Vacuum resistance		unlimited											

Output signal / Supply	
Standard	2-wire: 4 ... 20 mA / $V_S = 8 \dots 32 V_{DC}$
Options	3-wire: 0 ... 10 V / $V_S = 14 \dots 30 V_{DC}$ 3-wire ratiometric: $V_{Sig} = 0.5 \dots 4.5 V$ / $V_S = 5 \pm 0.5 V_{DC}$

Performance	
Accuracy <sup>1</sup>	≤ ± 1 % FSO
Permissible load	2-wire: $R_{max} = [(V_S - V_{Smin}) / 0.02 A] \Omega$ 3-wire: $R_{min} = 10 k\Omega$
Influence effects	supply: 0.05 % FSO / 10 V load: 0.05 % FSO / $k\Omega$
Response time	2-wire: ≤ 10 msec 3-wire: ≤ 3 msec
Measuring rate	1 kHz

<sup>1</sup> accuracy according to IEC 60770 – limit point adjustment (non-linearity, hysteresis, repeatability)

Thermal effects (Offset and Span) / Permissible temperatures			
Thermal error	≤ ± 0.5 % FSO / 10 K (typ.)	in compensated range	-25 ... 85 °C
Permissible temperatures	medium: -25 ... 125 °C	electronics / environment:	-25 ... 85 °C      storage: -40 ... 85 °C

Electrical protection	
Short-circuit protection	permanent      3-wire ratiometric: none
Reverse polarity protection	no damage, but also no function
Electromagnetic protection	emission and immunity according to EN 61326

Mechanical stability	
Vibration	10 g, 25 Hz ... 2 kHz      according to DIN EN 60068-2-6
Shock	500 g / 1 msec      according to DIN EN 60068-2-27

<b>Materials</b>	
Pressure port / housing	stainless steel 1.4301 (304)
Seals (media wetted)	FKM others on request
Diaphragm	ceramics Al <sub>2</sub> O <sub>3</sub> 96 %
Media wetted parts	pressure port, seals, diaphragm

<b>Miscellaneous</b>	
Weight	approx. 120 g
Current consumption	2-wire: max. 25 mA 3-wire ratiometric: typ. 1.5 mA 3-wire voltage: max. 7 mA (short circuit current: max. 20 mA)
Long term stability	≤ ± 0.3 % FSO / year at reference conditions
Operational life	> 100 x 10 <sup>6</sup> cycles
CE-conformity	EMC Directive: 2004/108/EC Pressure Equipment Directive: 97/23/EC (module A) <sup>2</sup>

<sup>2</sup> This directive is only valid for devices with maximum permissible overpressure > 200 bar

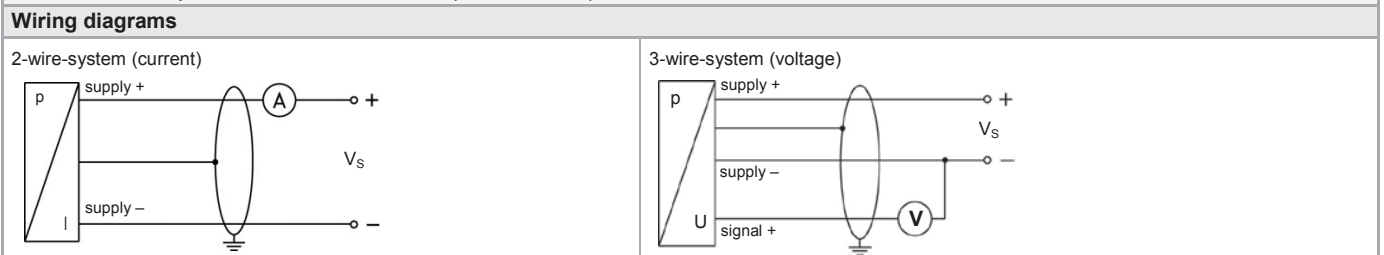

**Pin configuration**

Electrical connection	ISO 4400	Micro (contact distance 9.4 mm)	M12x1 (4-pin), plastic	cable colours (DIN 47100)
Supply +	1	1	1	wh (white)
Supply -	2	2	2	bn (brown)
Signal + (for 3-wire)	3	3	3	gn (green)
Shield	ground pin	ground pin	4	ye/gn (yellow / green)

**Electrical connections (dimensions in mm)**

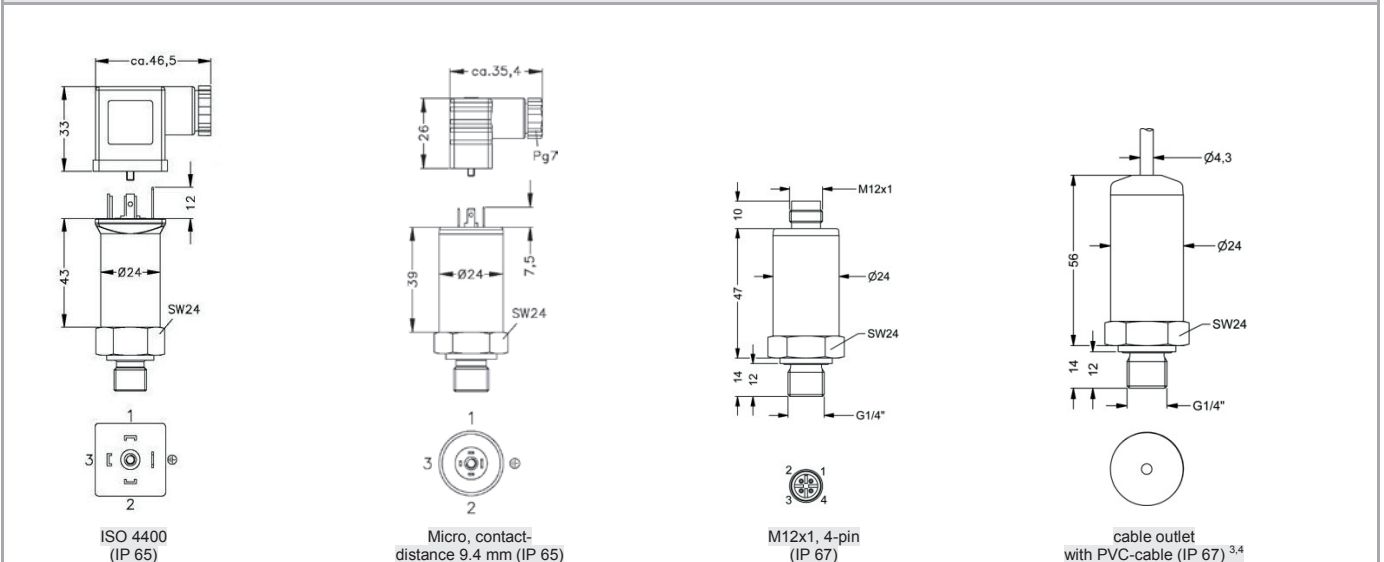

<sup>3</sup> standard: 2 m PVC cable without ventilation tube (permissible temperature: -5 ... 70 °C)  
<sup>4</sup> different cable types and lengths available, permissible temperature depends on kind of cable

**Mechanical connection (dimensions in mm)**



30.600 G -     -  -  -  -     -     - 2 -  -

<b>Input</b>	[bar]																			
	1.6	1	6	0	1															
	2.5	2	5	0	1															
	4.0	4	0	0	1															
	6.0	6	0	0	1															
	10	1	0	0	2															
	16	1	6	0	2															
	25	2	5	0	2															
	40	4	0	0	2															
	60	6	0	0	2															
	100	1	0	0	3															
	160	1	6	0	3															
	250	2	5	0	3															
	customer	9	9	9	9															consult
<b>Pressure</b>	gauge					R														
<b>Output</b>	4 ... 20 mA / 2-wire																			
	0 ... 10 V / 3-wire																			
	0.5 ... 4.5 V / 3-wire ratiometric					R														
	customer					9														consult
<b>Accuracy</b>	1.0 % FSO																			
	customer																			consult
<b>Electrical connection</b>	Male and female plug ISO 4400																			
	Male and female plug Micro																			
	Male plug M12x1 (4-pin), plastic																			
	Cable outlet with PVC cable <sup>1</sup>																			
	customer																			consult
<b>Mechanical connection</b>	G1/4" DIN 3852																			
	1/4" NPT																			
	customer																			consult
<b>Seal</b>	FKM																			
	customer																			consult
<b>Special version</b>	standard																			
	customer																			consult

<sup>1</sup> standard: 2 m PVC cable without ventilation tube (permissible temperature: -5 ... 70 °C)





# 17.609 G

## OEM Pressure Transmitter

### Application

- ▶ refrigeration

### Characteristics

- ▶ stainless steel sensor, welded
- ▶ accuracy 0.5 % FSO according to IEC 60770
- ▶ nominal pressure ranges from 0 ... 6 bar up to 0 ... 60 bar  
-1 ... 6 bar up to -1 ... 60 bar



### Technical Data

Pressure ranges							
Nominal pressure gauge [bar]		6	10	16	25	40	60
Overpressure [bar]		14	35	35	70	140	140
Burst pressure ≥ [bar]		28	70	70	140	280	280
Vacuum resistance		unlimited					

Vacuum ranges							
Nominal pressure gauge [bar]		-1 ... 6	-1 ... 10	-1 ... 16	-1 ... 25	-1 ... 40	-1 ... 60
Overpressure [bar]		14	35	35	70	140	140
Burst pressure [bar]		28	70	70	140	280	280

Output signal / Supply			
Standard	2-wire:	4 ... 20 mA	/ $V_S = 8 \dots 32 V_{DC}$
Options 3-wire	3-wire:	0 ... 10 V	/ $V_S = 14 \dots 30 V_{DC}$
	3-wire ratiometric:	$V_{Sig} = 0.5 \dots 4.5 V$	/ $V_S = 5 \pm 0.5 V_{DC}$

Performance			
Accuracy <sup>1</sup>	≤ ± 0.5 % FSO		
Permissible load	2-wire: $R_{max} = [(V_S - V_S min) / 0.02 A] \Omega$	3-wire: $R_{min} = 10 k\Omega$	
Influence effects	supply: 0.05 % FSO / 10 V		load: 0.05 % FSO / $k\Omega$
Response time	2-wire: ≤ 10 msec		3-wire: ≤ 3 msec
Measuring rate	1 kHz		

<sup>1</sup> accuracy according to IEC 60770 – limit point adjustment (non-linearity, hysteresis, repeatability)

Thermal effects (Offset and Span) / Permissible temperatures			
Thermal error	≤ ± 0.3 % FSO / 10 K	in compensated range	0 ... 70 °C
Permissible temperatures	medium: -40 ... 125 °C	electronics / environment:	-40 ... 85 °C storage: -40 ... 85 °C

Electrical protection	
Short-circuit protection	permanent 3-wire ratiometric: none
Reverse polarity protection	no damage, but also no function
Electromagnetic protection	emission and immunity according to EN 61326

Mechanical stability	
Vibration	20 g, 25 Hz ... 2 kHz according to DIN EN 60068-2-6
Shock	500 g / 1 msec according to DIN EN 60068-2-27

<b>Materials</b>	
Pressure port	stainless steel 1.4571 (316Ti)
Housing	stainless steel 1.4301 (304)
Seal of sensor	none (welded)
Diaphragm	stainless steel 1.4542 (630)
Media wetted parts	pressure port, diaphragm
<b>Miscellaneous</b>	
Mechanical connection	7/16"-20 UNF
Weight	approx. 120 g
Current consumption	2-wire: max. 25 mA                      3-wire ratiometric: typ. 3 mA 3-wire voltage: max. 7 mA (short circuit current: max. 20 mA)
Long term stability	$\leq \pm 0.3\%$ FSO / year at reference conditions
Operational life	$> 100 \times 10^6$ pressure cycles
CE-conformity	EMC Directive: 2004/108/EC

**Wiring diagrams**

2-wire-system (current)

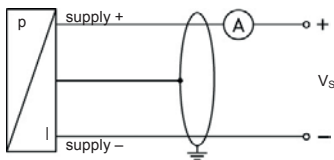

3-wire-system (voltage)

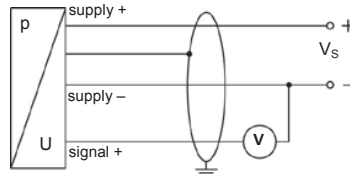
**Pin configuration**

Electrical connection	ISO 4400	Micro (contact distance 9.4 mm)	M12x1 (4-pin), plastic	cable colours (DIN 47100)
Supply +	1	1	1	wh (white)
Supply -	2	2	2	bn (brown)
Signal + (for 3-wire)	3	3	3	gn (green)
Shield	ground pin	ground pin	4	ye/gn (yellow / green)

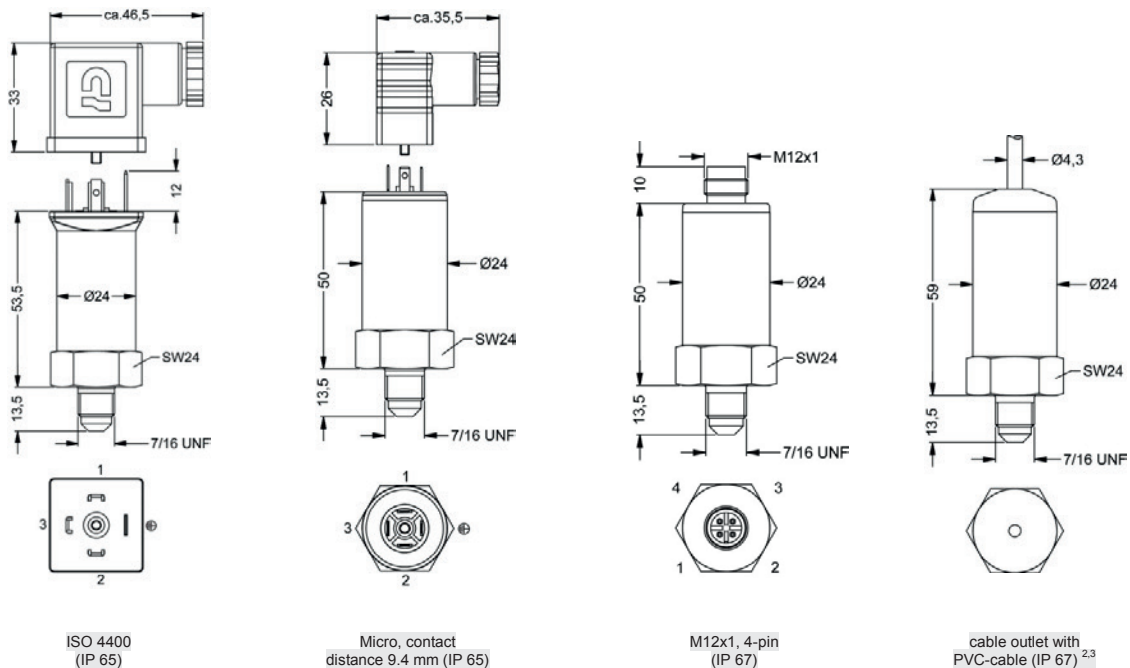
**Dimensions (in mm)**

<sup>2</sup> standard: 2 m PVC cable without ventilation tube (permissible temperature: -5 ... 70 °C)

<sup>3</sup> different cable types and lengths available, permissible temperature depends on kind of cable





# 17.600 G

## OEM Pressure Transmitter Heavy Duty

### Applications:

- ▶ mobile hydraulic
- ▶ presses
- ▶ general mechanical engineering
- ▶ oxygen application

### Characteristics:

- ▶ stainless steel sensor, welded
- ▶ accuracy 0.5 % FSO according to IEC 60770
- ▶ nominal pressure ranges from 0 ... 6 bar up to 0 ... 600 bar

## Technical Data



Input pressure range												
Nominal pressure gauge	[bar]	6	10	16	25	40	60	100	160	250	400	600
Overpressure (static)	[bar]	14	35	35	70	140	140	350	350	700	1 200	1 200
Burst pressure ≥	[bar]	28	70	70	140	280	280	700	700	1 400	1 500	1 500
Vacuum resistance		unlimited										

Output signal / Supply	
Standard	2-wire: 4 ... 20 mA / $V_S = 8 \dots 32 V_{DC}$
Options	3-wire: 0 ... 10 V / $V_S = 14 \dots 30 V_{DC}$ 3-wire ratiometric: $V_{Sig} = 0.5 \dots 4.5 V$ / $V_S = 5 \pm 0.5 V_{DC}$

Performance	
Accuracy <sup>1</sup>	≤ ± 0.5 % FSO
Permissible load	2-wire: $R_{max} = [(V_S - V_S \text{ min}) / 0.02 A] \Omega$ 3-wire: $R_{min} = 10 k\Omega$
Influence effects	supply: 0.05 % FSO / 10 V load: 0.05 % FSO / $k\Omega$
Response time	2-wire: ≤ 10 msec      3-wire: ≤ 3 msec
Measuring rate	1 kHz

<sup>1</sup> accuracy according to IEC 60770 – limit point adjustment (non-linearity, hysteresis, repeatability)

Thermal effects (Offset and Span) / Permissible temperatures			
Thermal error	≤ ± 0.3 % FSO / 10 K	in compensated range	0 ... 70 °C
Permissible temperatures	medium: -40 ... 125 °C	electronics / environment:	-40 ... 85 °C      storage: -40 ... 85 °C

Electrical protection	
Short-circuit protection	permanent      3-wire ratiometric: none
Reverse polarity protection	no damage, but also no function
Electromagnetic protection	emission and immunity according to EN 61326

Mechanical stability	
Vibration	20 g, 25 Hz ... 2 kHz      according to DIN EN 60068-2-6
Shock	500 g / 1 msec      according to DIN EN 60068-2-27

Materials	
Pressure port	stainless steel 1.4571 (316Ti)
Housing	stainless steel 1.4301 (304)
Seal of pressure port	FKM: G 1/4" DIN 3852                      others on request
Seal of sensor	none (welded)
Diaphragm	stainless steel 1.4542 (630)
Media wetted parts	pressure port, seal of pressure port, diaphragm

Miscellaneous	
Weight	approx. 120 g
Current consumption	2-wire: max. 25 mA                      3-wire ratiometric: typ. 3 mA 3-wire voltage: max. 7 mA (short circuit current: max. 20 mA)
Long term stability	≤ ± 0.3 % FSO / year
Operational life	> 100 x 10 <sup>6</sup> pressure cycles
CE-conformity	EMC Directive: 2004/108/EC                      Pressure Equipment Directive: 97/23/EC (module A) <sup>2</sup>

<sup>2</sup> This directive is only valid for devices with maximum permissible overpressure > 200 bar

**Wiring diagrams**

2-wire-system (current)

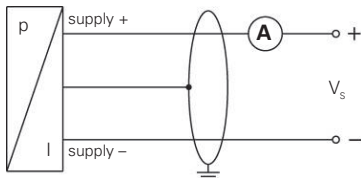

3-wire-system (voltage)

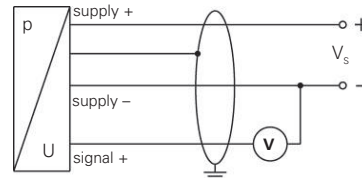

**Pin configuration**

Electrical connection	ISO 4400	Micro (contact distance 9.4 mm)	M12x1 (4-pin), plastic	cable colour (DIN 47100)
Supply +	1	1	1	wh (white)
Supply -	2	2	2	bn (brown)
Signal + (for 3-wire)	3	3	3	gn (green)
Shield	ground pin	ground pin	4	ye/gn (yellow / green)

**Electrical connections (dimensions in mm)**

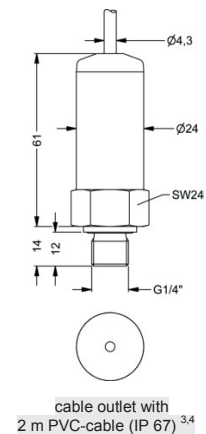
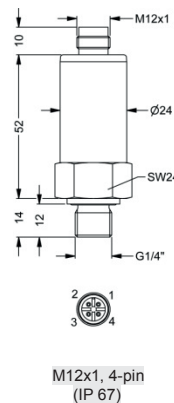
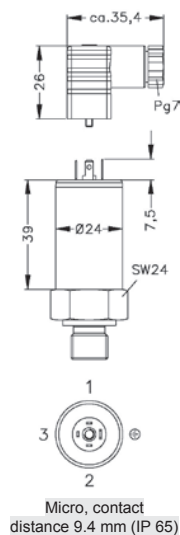
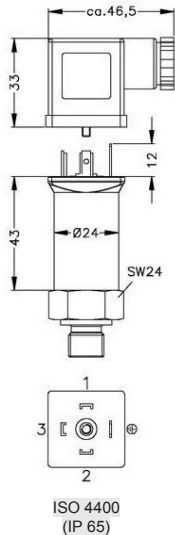

<sup>3</sup> standard: 2 m PVC cable without ventilation tube (permissible temperature: -5 ... 70 °C)

<sup>4</sup> different cable types and lengths available, permissible temperature depends on kind of cable

**Mechanical connection (dimensions in mm)**

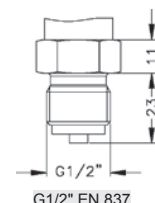
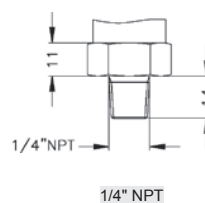
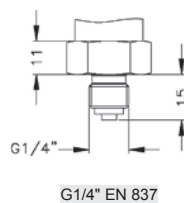
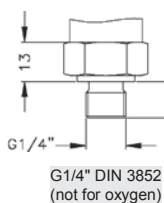





# DMK 456

## Pressure Transmitter with Stainless Steel Field Housing

Special application:  
Marine and Offshore

accuracy according to IEC 60770:  
standard: 0.25 % FSO  
option: 0.1 % FSO

### Nominal pressure

from 0 ... 40 mbar up to 0 ... 20 bar

### Output signals

2-wire: 4 ... 20 mA  
others on request

### Product characteristics

- ▶ GL-certificate (Germanischer Lloyd)
- ▶ DVN-certificate (Det Norske Veritas)
- ▶ CCS-certificate (China Classification Society)
- ▶ stainless steel field housing
- ▶ IS-version (temperature class T6)  
Ex ia = intrinsically safe for gases and dusts
- ▶ high overpressure resistance





### Optional versions

- ▶ diaphragm Al<sub>2</sub>O<sub>3</sub> 99.9 %
- ▶ different inch threads and flush versions

The pressure transmitter DMK 456 has been developed for measuring the pressure in systems and the level in tanks. It has been certified by Germanischer Lloyd (GL) and is therefore predestined for shipbuilding and offshore applications.

Due robust stainless steel field housing and the possibility to use the device in intrinsic safe areas (temperature class T6) enable to measure the pressure of aggressive gases and fluids under extreme operating conditions. The basis for the DMK 456 is a capacitive ceramic sensor element designed by BD|SENSORS, which offers a high overload resistance and medium compatibility.

### Preferred areas of use are

-  Monitoring of the pressure during loading and unloading processes
-  Monitoring of a ship's position and draught
-  Use in anti-heeling systems
-  Level measurement in ballast and storage tanks
-  Monitoring of the internal pressure in liquid gas cargo tanks



Pressure ranges																
Nominal pressure <sup>1</sup>	[bar]	0.04	0.06	0.1	0.16	0.25	0.4	0.6	1	1.6	2.5	4	6	10	16	20
Level	[mH <sub>2</sub> O]	0.4	0.6	1	1.6	2.5	4	6	10	16	25	40	60	100	160	200
Permissible overpressure	[bar]	2	2	4	4	6	6	8	8	15	25	25	35	35	45	45
Permissible vacuum	[bar]	-0.2		-0.3		-0.5			-1							

<sup>1</sup> available in gauge, sealed gauge and absolute; nominal pressure ranges sealed gauge and absolute from 1 bar

Output signal / Supply	
Standard	2-wire: 4 ... 20 mA IS-version / V <sub>S</sub> = 14 ... 28 V <sub>DC</sub> <span style="float: right;">V<sub>S rated</sub> = 24 V<sub>DC</sub></span>
Performance	
Accuracy <sup>2</sup>	standard: $\leq \pm 0.25\%$ FSO options: P <sub>N</sub> $\geq 0.6$ bar <sup>3</sup> : $\leq \pm 0.1\%$ FSO
Permissible load	R <sub>max</sub> = [(V <sub>S</sub> - V <sub>S min</sub> ) / 0.02 A] Ω
Long term stability	$\leq \pm 0.1\%$ FSO / year
Influence effects	supply: 0.05 % FSO / 10 V load: 0.05 % FSO / kΩ
Turn-on time	700 msec
Mean response time	< 200 msec <span style="float: right;">mean measuring rate 5/sec</span>
Max. response time	380 msec

<sup>2</sup> accuracy according to IEC 60770 – limit point adjustment (non-linearity, hysteresis, repeatability)

<sup>3</sup> Under the influence of disturbance burst according to EN 61000-4-4 (2004) +2 kV accuracy decreased to  $\leq \pm 0.25\%$  FSO.

Thermal effects / Permissible temperatures	
Thermal error	$\leq \pm 0.1\%$ FSO / 10 K in compensated range -20 ... 80 °C
Permissible temperatures	medium: -25 ... 125 °C electronics / environment: -25 ... 85 °C storage: -40 ... 100 °C

Electrical protection	
Short-circuit protection	permanent
Reverse polarity protection	no damage, but also no function
Electromagnetic compatibility	emission and immunity according to EN 61326 and Germanischer Lloyd (GL)

Mechanical stability	
Vibration	4 g (according to GL: curve 2 / basis: DIN EN 60068-2-6)

Materials	
Pressure port	stainless steel 1.4404 (316 L)
Housing	stainless steel 1.4404 (316 L)
Cable gland	brass, nickel plated others on request
Seals	FKM; others on request
Diaphragm	standard: ceramics Al <sub>2</sub> O <sub>3</sub> 96 % option: ceramics Al <sub>2</sub> O <sub>3</sub> 99.9 %
Media wetted parts	pressure port, seals, diaphragm

IS protection	
Approval DX14A-DMK 456	IBExU07ATEX1180 X zone 0: II 1G Ex ia IIC T6
Safety techn. maximum values	U <sub>i</sub> = 28 V, I <sub>i</sub> = 93 mA, P <sub>i</sub> = 660 mW, C <sub>i</sub> = 52.3 nF, L <sub>i</sub> = 5 μH, the supply connections have an inner capacity of max. 90,2 nF opposite the enclosure
Permissible temperatures for environment	-20 ... 60 °C in zone 0: with p <sub>atm</sub> 0.8 up to 1.1 bar

Miscellaneous	
Ingress protection	IP 67
Installation position	any
Current consumption	max. 21 mA
Weight	min. 400 g (depending on housing and mechanical connection)
Operational life	> 100 x 10 <sup>6</sup> cycles
CE conformity	EMC Directive: 2004/108/EC
ATEX Directive	94/9/EC

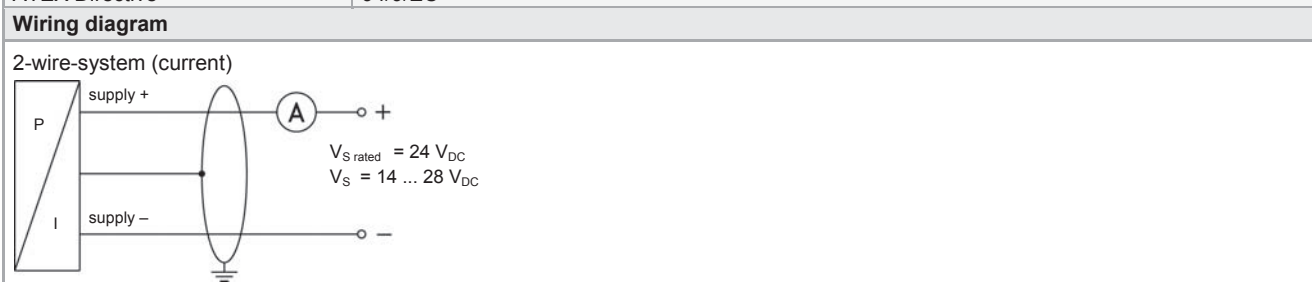



Pin configuration	
Electrical connections	field housing (clamp section: 2.5 mm <sup>2</sup> )
Supply +	IN+
Supply -	IN-
Ground	

**Dimensions (in mm)**

**Inch thread**

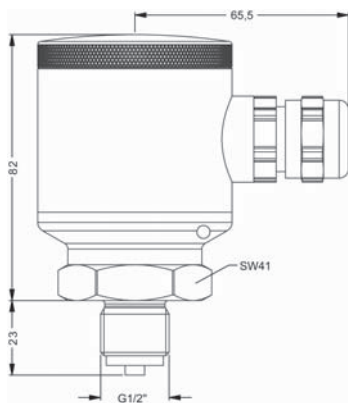

G1/2" EN 837

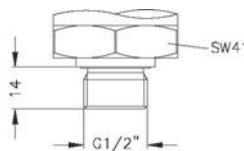

G1/2" DIN 3852

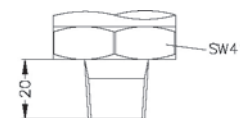

1/2" NPT

**Flange (DIN 2501)**

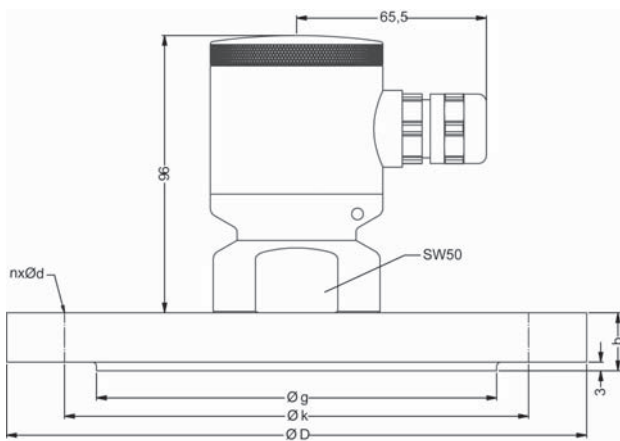

dimensions in mm			
Maß	DN25	DN50	DN80
D	115	165	200
k	85	125	160
g	68	102	138
b	18	20	20
n	4	4	8
d	14	18	18
P <sub>N</sub> [bar]	≤ 40	≤ 40	≤ 16

**Flange (ANSI)**

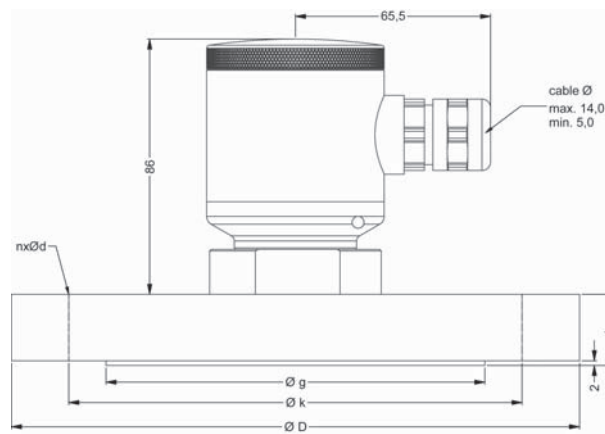

dimensions in mm		
size	2"/150 lbs	3"/150 lbs
D	152.4	190.5
g	91.9	127
k	120.7	152.4
b	19.1	23.9
n	4	4
d	19.1	19.1
P <sub>N</sub> [bar]	≤ 10	≤ 10

\* for gauge pressure ranges, the marked dimension increases by 8 mm!

## DMK 456



<b>Pressure</b>										
	in bar, gauge		5	9	5					
	in bar, absolute <sup>1</sup>		5	9	6					consult
	in mH <sub>2</sub> O, gauge		5	9	7					
	in mH <sub>2</sub> O, absolute <sup>1</sup>		5	9	8					consult
<b>Input</b>										
	[mH <sub>2</sub> O]	[bar]								
	0.40	0.04		0	4	0	0			
	0.60	0.06		0	6	0	0			
	1.0	0.10		1	0	0	0			
	1.6	0.16		1	6	0	0			
	2.5	0.25		2	5	0	0			
	4.0	0.40		4	0	0	0			
	6.0	0.60		6	0	0	0			
	10	1.0		1	0	0	1			
	16	1.6		1	6	0	1			
	25	2.5		2	5	0	1			
	40	4.0		4	0	0	1			
	60	6.0		6	0	0	1			
	100	10		1	0	0	2			
	160	16		1	6	0	2			
	200	20		2	0	0	2			
	customer			9	9	9	9			consult
<b>Output</b>										
	Intrinsic safety 4 ... 20 mA / 2-wire							E		
	customer							9		consult
<b>Accuracy</b>										
	standard	0.25 %						2		
	option for PN ≥ 0,6 bar:	0.1 %						1		
	customer							9		consult
<b>Electrical connection</b>										
	Field housing							8	8	0
	customer							9	9	9
<b>Mechanical connection</b>										
	G1/2" DIN 3852							1	0	0
	G1/2" EN 837							2	0	0
	1/2" NPT							N	0	0
	Flange DN 25 / PN 40 (DIN 2501)							F	2	0
	Flange DN 50 / PN 40 (DIN 2501)							F	2	3
	Flange DN 80 / PN 16 (DIN 2501) <sup>2</sup>							F	1	4
	Flansch DN 2" / 150 lbs (ANSI B16.5) <sup>2</sup>							F	3	2
	Flansch DN 3" / 150 lbs (ANSI B16.5) <sup>2</sup>							F	3	3
	customer							9	9	9
<b>Seals</b>										
	FKM							1		
	customer							9		consult
<b>Pressure port</b>										
	Stainless steel 1.4404 (316L)							1		
	customer							9		consult
<b>Diaphragm</b>										
	Ceramics Al <sub>2</sub> O <sub>3</sub> 96%							2		
	Ceramics Al <sub>2</sub> O <sub>3</sub> 99,9%							C		
	customer							9		consult
<b>Special version</b>										
	standard							0	0	0
	customer							9	9	9

<sup>1</sup> nominal pressure ranges absolute from 1 bar; sealed gauge on request

<sup>2</sup> 2"/150 lbs and 3"/150 lbs possible for nominal pressure ranges P<sub>N</sub> ≤ 10 bar



# HU 300

## Hammer Union Pressure Transmitter

special application  
petrochemical industry / offshore

accuracy according to IEC 60770:  
0.5 % FSO

### Nominal pressure

from 0 ... 5 000 psi up to 0 ... 15 000 psi

### Output signals

2-wire: 4 ... 20 mA

3-wire: 0 ... 5 V

4-wire: 3 mV/V

others on request

### Product characteristics

- ▶ extreme robust and stable
- ▶ vibration / shock

### Optional versions

- ▶ IS-version zone 0 / 1  
(only for 4 ... 20 mA / 2-wire)
- ▶ different output signals

### Versions on request

- ▶ pressure port in Inconel®
- ▶ electrical connection Glenair (4-pin)
- ▶ mechanical connection  
WECO® 2" (2002/2202)

The pressure transmitter HU 300 has been especially developed for extreme operating conditions in the petrochemical industry (on- and offshore sites). A high degree of reliability and accuracy is the precondition for a perfect function during cementing and tightening processes (annulus) on wellbores.

A one-piece pressure port, a high-quality pressure sensor and precise machining and assembly techniques ensure a small drifting and a high long-term stability. A very high resistance against vibration, shock and pressure peaks without any influence on the measurement characteristics is guaranteed. Due to the extreme environmental conditions on-site, it is important to offer solutions to different requirements, as f. ex. an intrinsic-safe version (zone 0), an electrical connection with IP 68 or special steel materials.

### Preferred areas of use are



cementing wellbores

hydraulic fracturing

intensifying wellbores



Pressure ranges					
Nominal pressure	[psi]	5 000	6 000	10 000	15 000
Permissible overpressure	[psi]	7 500	9 000	15 000	22 500
Burst pressure $\geq$	[psi]	10 000	12 000	20 000	30 000

Supply	
Standard	2-wire: 4 ... 20 mA / $V_S = 10 \dots 30 V_{DC}^1$
Ex-protection	2-wire: 4 ... 20 mA / $V_S = 14 \dots 28 V_{DC}^1$
In preparation (only possible with MIL- / Bendix-connector)	3-wire: 0 ... 5 V / $V_S = 14 \dots 30 V_{DC}$ 4-wire: 3 mV/V / $V_S = 6 \dots 10 V_{DC}$

<sup>1</sup> valid for temperature from -40 ... 85 °C; for higher temperatures the supply has to be limited

Performance	
Accuracy	IEC 60770: $\leq \pm 0.5 \%$ FSO
Permissible load	current 2-wire: $R_{max} = [(V_S - V_{S \min}) / 0.02 A] \Omega$ voltage 3-wire: $R_{min} \geq 10 k\Omega$ voltage 4-wire: $R_{min} \geq 100 k\Omega$
Influence effects	supply: 0.05 % FSO / 10 V load: 0.05 % FSO / $k\Omega$
Long term stability	$\leq \pm 0.5 \%$ FSO per 6 months
Response time	$\leq \pm 1.5$ msec

Thermal effects (Offset and Span)	
Thermal errors	$\leq \pm 2 \%$ FSO / 100 K in compensated range -5 ... 60 °C

Permissible temperatures	
Permissible temperatures	medium / environment: -40 ... 125 °C storage: -55 ... 125 °C

Calibration	
Calibration signal accuracy	$\leq \pm 0.2 \%$ FSO
Calibration signal	80 % FSO (16.8 mA)

Electrical protection	
Short-circuit protection	permanent
Reverse polarity protection	no damage, but also no function
Electromagnetic compatibility	emission and immunity according to EN 61326

Mechanical stability	
Vibration	20g, 25 Hz ... 2 kHz according to DIN EN 60068-2-6 7.5 g <sub>RMS</sub> , 5 Hz – 1 kHz according to DIN EN 60068-2-64
Shock	500 g / 1 msec according to DIN EN 60068-2-27
Free Fall	1 m (free fall base: steel) according to DIN EN 60068-2-32

Materials	
Pressure port / diaphragm	standard: stainless steel 1.4548 (316L) on request: Inconel X750® Inconel X718®
Housing	stainless steel 1.4404 (316L)
Media wetted parts	pressure port

Explosion protection (only for 4 ... 20 mA / 2-wire)	
Approval DX 18-HU 300	IBExU08ATEX1127 X zone 0/1: II 1/2 G Ex ia IIC T4
Safety technical maximum values	$U_i = 28 V$ , $I_i = 100 mA$ , $P_i = 700 mW$ , $C_i = 1 nF$ , $L_i = 5 \mu H$ , The supply connections have an inner capacity of max. 27 nF opposite the housing.
Permissible temperatures for medium	-40 ... 70 °C
Permissible temperatures for environment	in zone 0: -20 ... 60 °C with $p_{atm}$ 0.8 bar up to 1.1 bar in zone 1: -25 ... 70 °C

Miscellaneous	
Connecting cables (by factory)	cable capacitance: signal line/shield also signal line/signal line: 150 pF/m cable inductance: signal line/shield also signal line/signal line: 1 µH/m
Current consumption	2-wire signal output current: max. 50 mA 3-wire signal output voltage: approx. 15 mA 4-wire signal output voltage: 29 mA @ 10 V
Installation position	any
Weight	2.1 kg

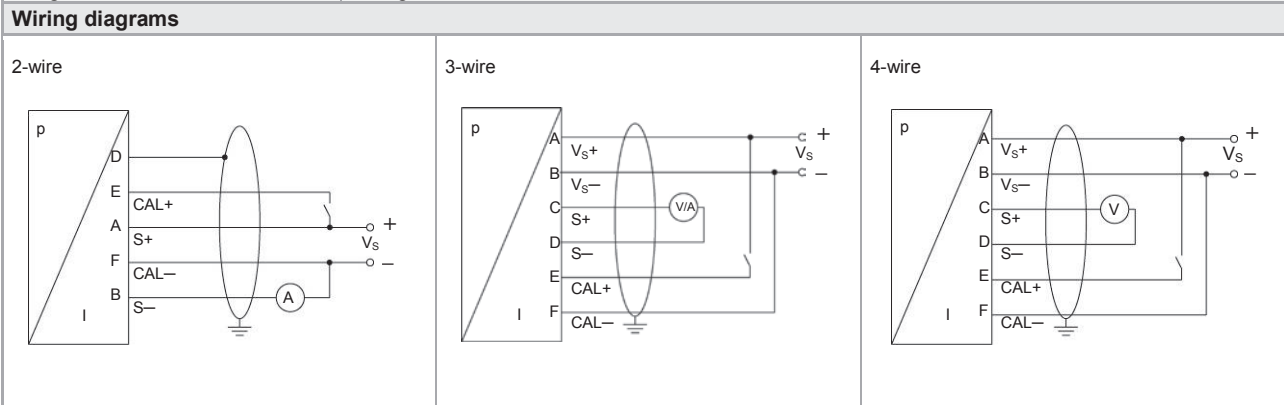

Pin configuration			
Electrical connection	MIL-/ Bendix (6-pin)	Glenair (4-pin)	cable colours (DIN 47100)
Supply +	pin A	pin C	wh (white)
Supply -	pin B	pin B	bn (brown)
Calibration +	pin E	pin D	pk (pink)
Calibration -	pin F	pin A	gy (grey)
for 3-wire / 4-wire:			
Signal +	pin C	-	-
Signal -	pin D	-	-
Shield	cable shield / for 2-wire: pin D	plug housing	ye/gn (yellow / green)

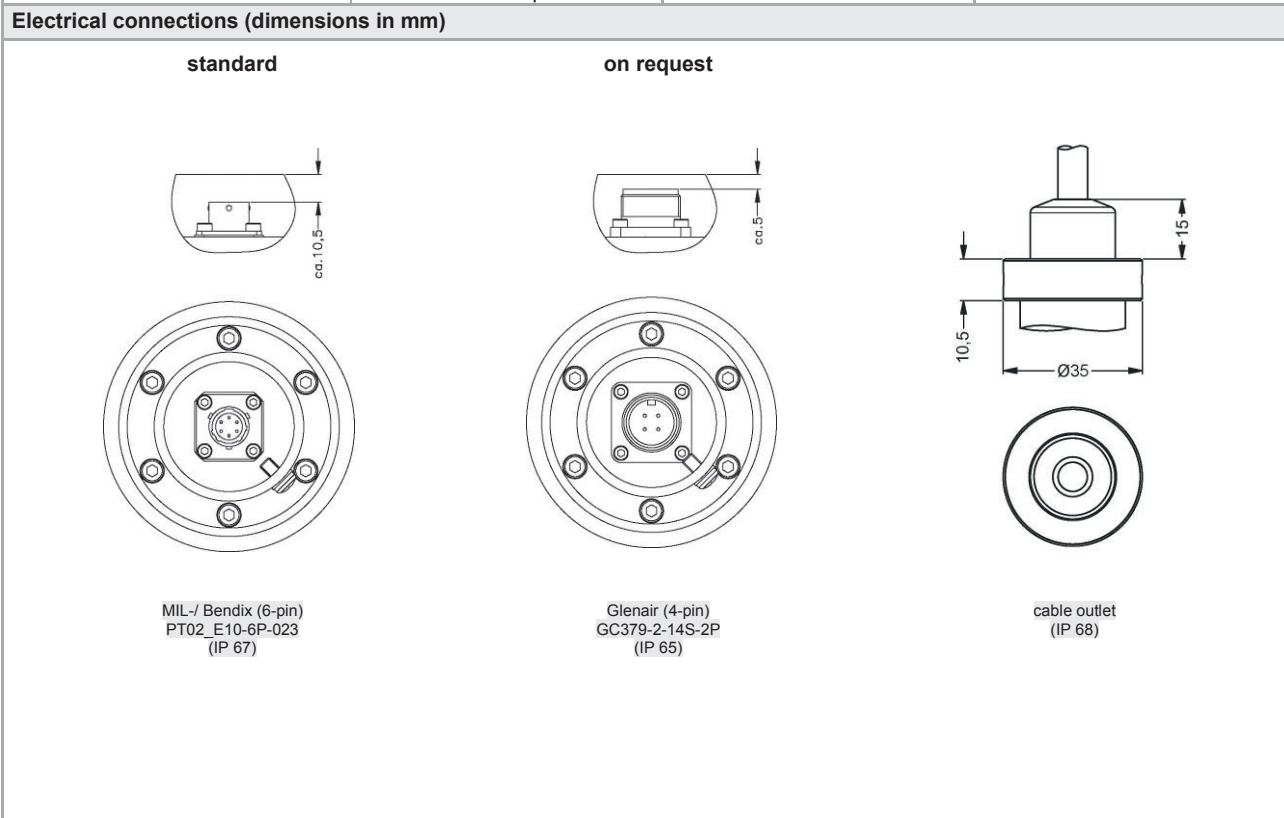

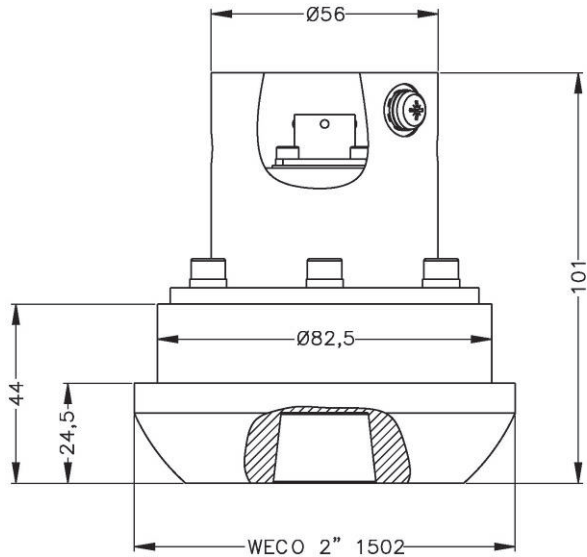
**Mechanical connection (dimensions in mm)**
**standard**

WECO® 2" (1502)

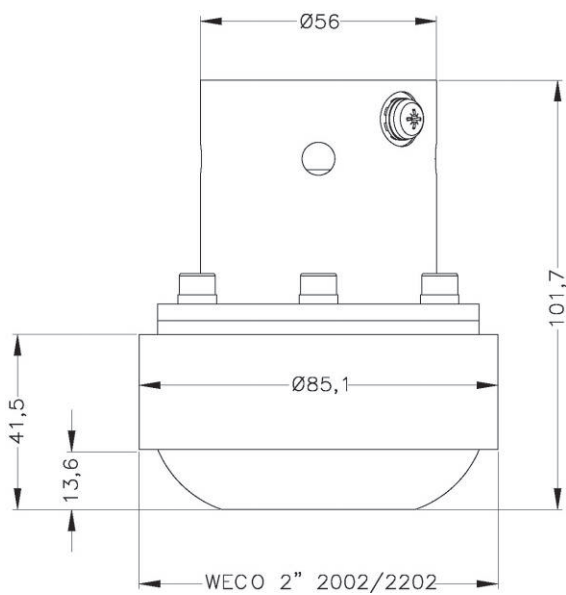
**on request**

WECO® 2" (2002/2202)

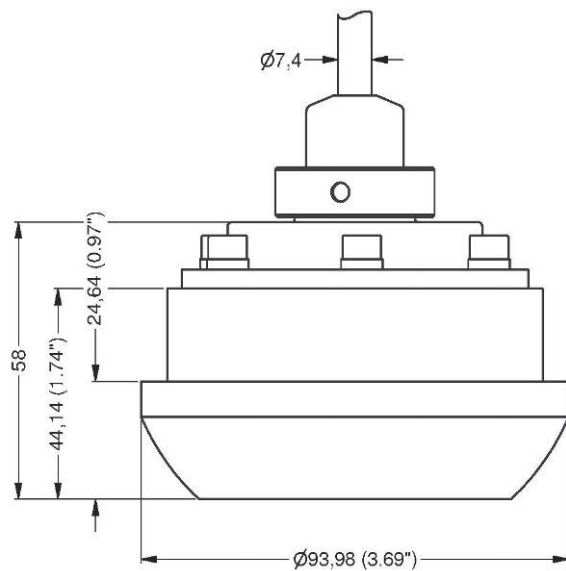

cable outlet

Inconel® is a registered trade mark of Special Metals Corporation.  
 WECO® is a registered trade mark of FMC Technologies.

This document contains product specifications; properties are not guaranteed. Subject to change without notice.

# HU 300

## Ordering Code

### HU 300



<b>Standard version</b>		H U 0																	
<b>Input</b>	[psi]																		
	5 000	P	5	K	0														
	6 000	P	6	K	0														
	10 000	P	1	0	K														
	15 000	P	1	5	K														
	customer	9	9	9	9														consult
<b>Output</b>																			
	4 ... 20 mA / 2-wire				1														
	Intrinsic safety 4 ... 20 mA / 2-wire				E														
	0 ... 5 V / 3-wire				4														in preparation
	3 mV/V / 4-wire				V3														in preparation
	customer				9														consult
<b>Accuracy</b>																			
	0.5 %				5														
	customer				9														consult
<b>Electrical connection <sup>1</sup></b>																			
	MIL-/ Bendix (6-pin)																		
	type PT02_E10-6P-023					B	2	0											
	Glenair (4-pin)					B	Z	0											
	GC379-2-14S-2P																		
	Cable outlet IP 68					T	R	2											
	with FEP cable																		
	customer					9	9	9											consult
<b>Mechanical connection</b>																			
	WECO 2" 1502					H	U	0											
	WECO 2" 2002/2202					H	U	1											consult
	customer					9	9	9											consult
<b>Material pressure port</b>																			
	Stainless steel 1.4548 (17-4PH)																		
	customer																		consult
<b>Material diaphragm</b>																			
	Stainless steel 1.4548 (17-4PH)																		
	customer																		consult
<b>Special version</b>																			
	standard																		0 0 0
	customer																		9 9 9

<sup>1</sup> only male plugs

WECO® is a registered trade mark of FMC Technologies







## COMPETENCE

---

Industrial pressure measurement technology from 0.1 mbar up to 6000 bar

- pressure transmitters, electronic pressure switches or hydrostatic level probes

---

- OEM or high-end products

---

- standard products or customized solutions

---

BD|SENSORS has the right pressure measuring device at the right price.

## PRICE / PERFORMANCE

---

pressure measurement at the highest level

The concentration on electronic pressure transmitter has led to extraordinary efficiency and economical pricing.

BD|SENSORS is certain to be one of the most economical suppliers on the world market, given equal technical and commercial conditions.

## RELIABILITY

---

projectable delivery times and strict observance of deadlines

Short delivery times and firm deadlines, even for special designs, make BD|SENSORS a reliable partner for our customers.

BD|SENSORS reduces the level of your stock-keeping and increases your profitability.

## FLEXIBILITY

---

We have special solutions for your individual requirement.

We solve your problem in industrial pressure measurement quickly and economically, not only with large-scale production lines, but also for smaller requirements.

BD|SENSORS is especially flexible when technical support and quick assistance are required in service case as well as for rush orders.

## INDUSTRIES



plant and machine engineering



chemical and biochemical industry



energy industry



renewable energy



semiconductor industry /  
cleanroom technology



HVAC



hydraulics



refrigeration



calibration techniques



laboratory techniques



medical technology



food and beverage



vehicles and mobile hydraulics



oil and gas industry



pharmaceutical industry



marine / shipbuilding / offshore



heavy industry



environmental industry



packaging and paper industry

## MEDIA



sewage



aggressive media



colours



gases



fuels and oils



pasty and viscous media



oxygen



water



*DISTRIBUTION WORLDWIDE  
HEADQUARTER OF BD|SENSORS GROUP*

*BD | SENSORS GmbH  
BD-Sensors-Straße 1  
95199 THIERSTEIN  
GERMANY*

*Tel.: +49 9235 9811-0  
Fax: +49 9235 9811-11*

*www.bdsensors.de  
info@bdsensors.de*

*DISTRIBUTION EASTERN EUROPE*

*BD | SENSORS s.r.o.  
Hradištská 817  
687 08 BUCHLOVICE  
CZECH REPUBLIC*

*Tel.: +420 572 411-011  
Fax: +420 572 411-497*

*www.bdsensors.cz  
sale@bdsensors.cz*