

Flexible Heaters

Flexible Heaters	Sheath Materials	Max. Operating Temperatures		Typical Max. Watt Densities		Page
		°F	°C	W/in ²	W/cm ²	
Silicone Rubber	Silicone rubber	500	260	80.0	12.50	119
Line Heating	Silicone rubber	392	200	2.5	0.39	133
Polyimide	Polyimide	392	200	50.0	7.75	148
SERIES EHG[®] Controller	N/A	158*	70*	N/A		152
SERIES EHG SL10 Controller with Limit	N/A	158*	70*	N/A		154
SERIES EHG CL Controller	N/A	158*	70*	N/A		158

* Ambient environment, not maximum controlling temperature.

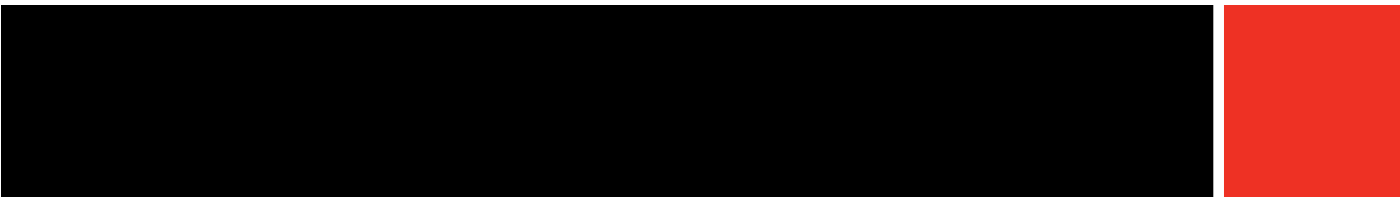



Flexible Heaters

Flexible Shapes and Geometries

Flexible heaters are thin, bendable and shaped to fit almost any type of equipment. Heat can be applied to complex shapes and geometries without sacrificing efficiency or dependability.

Excellent heat transfer results from the heater's thin design and direct bonding to an application. Flexible heaters provide fast heat-up and cool-down rates, uniform heat distribution and high watt densities.

Features and Benefits

Flat geometry

- Permits holes, notches and unusual shapes

Option of two material types and two element styles

- Allow wider flexibility

Lightweight construction and low thermal mass

- Permit use in applications with limited space or weight requirements

Heating elements as close as 0.003 in. (0.08 mm)

- Creates faster heat-up and cool-down time

Uniformly spaced element paths

- Distributes heat more evenly

Typical Applications

- Medical equipment including blood analyzers, respiratory therapy units and hydrotherapy baths
- Semiconductor equipment, including vacuum and gas delivery lines and wafer processing equipment
- Foodservice equipment, including food holding and warming cabinets
- Battery heating
- Satellite and communication equipment
- Freeze protection for military hardware, aircraft instrumentation, hydraulic equipment, etc.
- Any application requiring a flexible shape or design

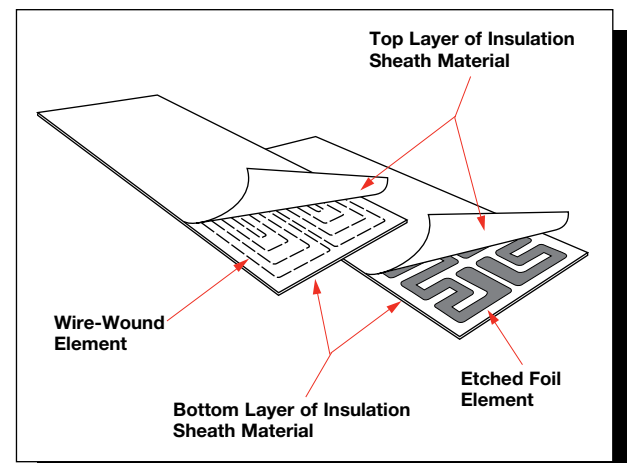
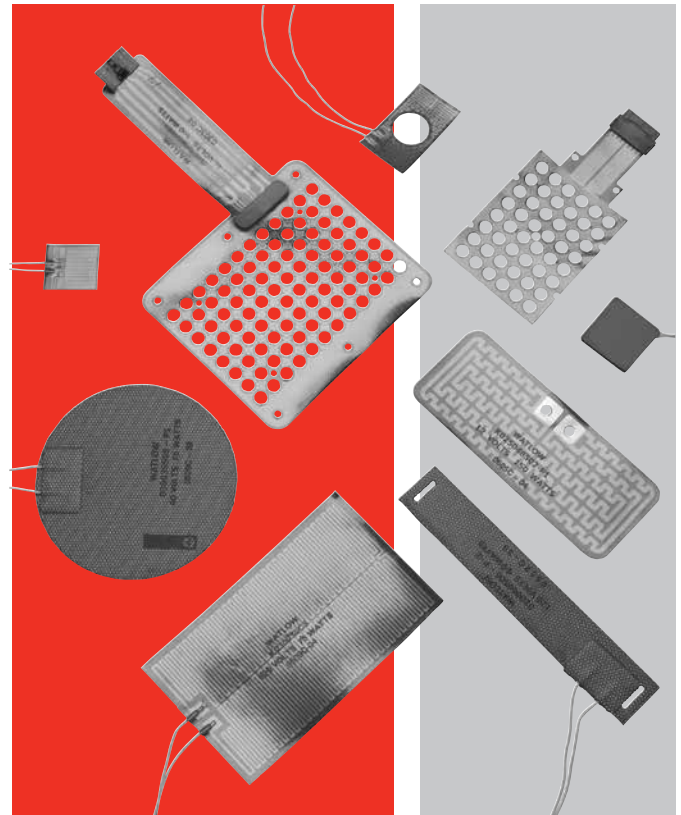

Flexible Heaters

Flexible Shapes and Geometries

Applications and Technical Data

Two Material Types

Silicone Rubber

Rugged, moisture- and chemical-resistant material easily can be bonded to parts for effective heat transfer. Watlow silicone rubber heaters handle temperatures up to 500°F (260°C). Many heater styles are available with UR®, cUR®, VDE and CE recognition.

Polyimide

Polyimide is a thin, lightweight transparent material designed for precise heating requirements ranging from -319 to 392°F (-195 to 200°C). It is ideal for applications requiring low outgassing in a vacuum or resistance to radiation, fungus and chemicals. Many custom heaters can be UR® and cUR® recognized.

Two Element Types

Watlow offers wire-wound and etched foil resistance elements for silicone rubber heaters. Watlow can recommend the type best suited to your application.

Wire-Wound Elements

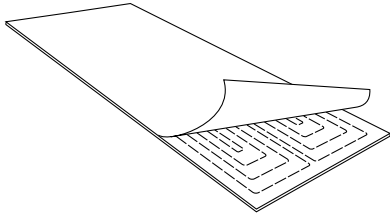

This element style is created by spiraling fine resistance wires around a fiberglass cord. The element is laid out in a pattern designed for a specific application. The benefits of wire-wound elements include:

- Excellent physical strength and flexibility. Repeated heater flexing has no harmful effects on its performance
- The ability to conform easily to curved surfaces, including small radius bends

Semiconductor pumpline heaters are typical examples of applications that use the wire-wound method. These heaters are flexed repeatedly during removal and installation, but due to their wiring, no internal damage occurs.

Etched Foil Elements

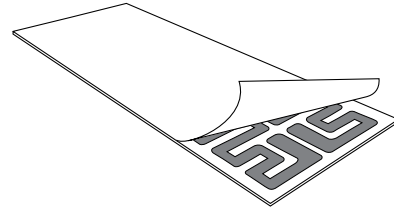

This element type is created by acid etching a circuit in nickel alloy resistance foil. It is available in silicone rubber and polyimide heater types. The etched foil element is known for its excellent circuit pattern repeatability and superior heat transfer, which results from greater coverage of the element. Other benefits include:

- Delivery of more heat and up to twice the watt density of a wire-wound element provides longer heater life
- Complex heat distribution patterns

The etched foil element style is usually recommended for applications requiring high temperatures, watt densities, or multiple zoning.

Flexible Heaters

Silicone Rubber Heaters

Rugged, yet thin, lightweight and flexible — use of Watlow® silicone rubber heaters is limited only by the imagination. Heat can be put exactly where it is needed to improve heat transfer, speed warm ups and decrease wattage requirements in an application process.

Fiberglass-reinforced silicone rubber provides dimensional stability without sacrificing flexibility. Because very little material separates the element from the part, heat transfer is rapid and efficient. Heaters are constructed with a wire-wound element or with an etched foil element. Its thin construction allows it to fit into applications where space is limited.

Performance Capabilities

- Operating temperatures up to 500°F (260°C)
- Watt densities up to 80 W/in² (12.5 W/cm²), dependent upon application temperature
- Wire-wound element thickness — 0.055 in. (1.4 mm)
- Etched foil element — 0.022 in. (0.56 mm)
- UR®, cUR®, VDE and CE recognitions are available on many designs up to 428°F (220°C)

Features and Benefits

Designed to the exact shape and size needed

- Conforms to component and/or equipment

More than 80 designs available immediately from stock

- Reduces downtime

Constructed with wire-wound or etched foil elements

- Enables a thin, lightweight heater
- Provides the desired flexibility for many dynamic applications
- Delivers low mass and easily repeatable distributed watt densities

Moisture and chemical-resistant silicone rubber material

- Provides longer heater life

Vulcanizing adhesives or fasteners

- Allows heaters to be easily bonded to parts

Typical Applications

- Semiconductor processing equipment
- Freeze protection and condensation prevention for many types of instrumentation and equipment
- Medical equipment such as blood analyzers and test tube heaters
- Computer peripherals such as laser printers
- Curing of plastic laminates
- Photo processing equipment

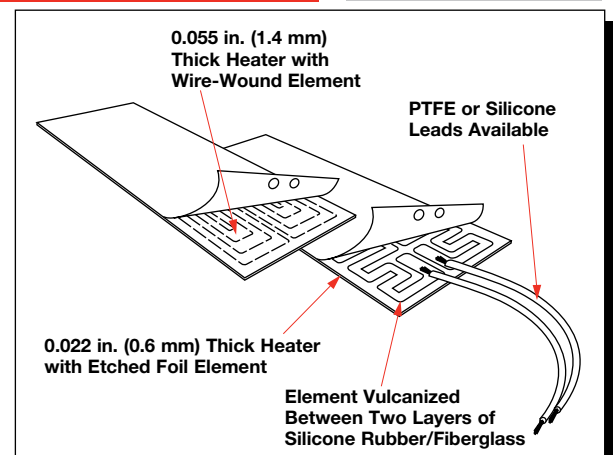

Flexible Heaters

Silicone Rubber Heaters

Mounting Methods

Watlow offers various attachment techniques designed for fast installation.

Pressure Sensitive Adhesive Surface (PSAS)

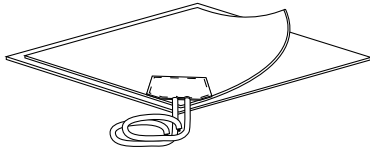

For speed, convenience and economy of installation, specify PSAS. Simply peel off the protective backing and roll the heater in place for an even bond to a clean, smooth surface. PSAS is not recommended for curved surfaces or for heaters rated above 10 W/in² (1.5 W/cm²). It should not be used for applications exceeding 400°F (205°C) on silicone rubber and 300°F (150°C) on polyimide.

Note: PSAS has a maximum six-month storage life at or below 86°F (30°C) before heater installation.

Field Applied Adhesive

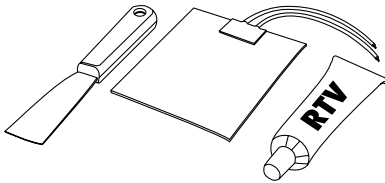

For a stronger bond or when long storage is probable, room temperature vulcanizing (RTV) silicone adhesive works well. Watlow offers red RTV for temperatures up to 500°F (260°C). White RTV is available from adhesive suppliers for temperatures up to 400°F (205°C). Watlow's one-part RTV is self-priming and can be ordered in either 3 oz (90 ml) or 12 oz (355 ml) tubes. For larger heaters requiring longer adhesive working time, two-part RTV kits can be purchased from adhesive suppliers. These kits require primer on the surface prior to adhesive application.

Note: Not recommended for polyimide heaters.

Silicone Contact Cement Kit

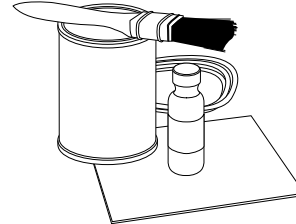

This two-part adhesive consists of a resin and catalyst that are easily mixed together and applied with a paintbrush. Recommended usage is for field cementing of silicone rubber heaters to customer parts. Available for immediate delivery, the cement kit handles temperatures up to 350°F (175°C). The resin is available in pint or quart containers. To order, specify **silicone contact cement** and the container size.

Mechanical Fasteners

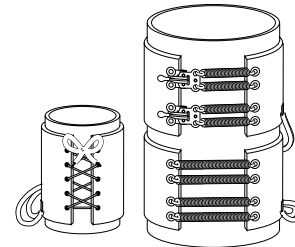

When a wire-wound flexible heater must be detachable, any type of fastener normally used with fabrics can usually be built into the flexible heater's sheath material. The most common types are latch fasteners, boot hooks and grommets. Other styles include snap fasteners, springs and lacing cord. (Hook and loop style fastener strips are only available as part of the extended capabilities offering.) Grommets and boot hooks are commonly used with tension springs to compensate for slight variations in part size.

Flexible Heaters

Silicone Rubber Heaters

Termination Styles

Watlow offers many types of leads and terminations. Leads can project from any position along the perimeter of the unit. **They are centered on the short side width of rectangular heaters unless specified.**

PTFE UL® 1180 CSA

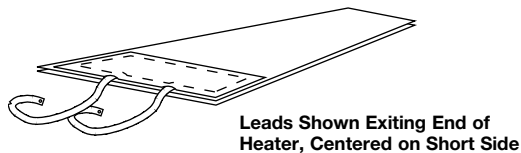

Watlow's leads are 12 in. (305 mm) long, white, PTFE insulated, flexible, plated copper UL® 1180 CSA wire. Leads are rated for 392°F (200°C)/300V. Lead connections on or at the heater are insulated with a cap of sheath material vulcanized to the heater body.

PTFE Leads



PTFE Type E (MIL-W-16878) and PTFE UL® 1199 leads rated for 392°F (200°C)/600V are also available.

Silicone Insulated Leads

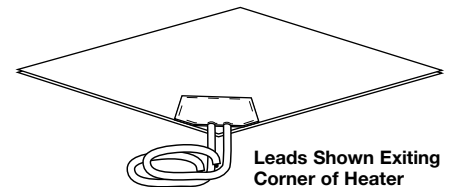

For a better moisture seal, specify UL® silicone insulated lead wires. This lead type is rated for 302°F (150°C)/600V. Any lead length is available. **Note:** Silicone rubber heaters are not designed to be waterproof. Excess exposure to moisture may facilitate premature heater failure.

Option

Thermal Insulation

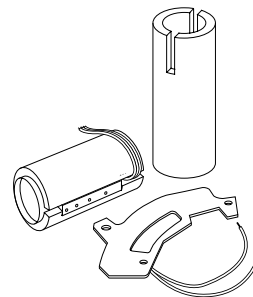

To increase heating efficiency of your application, silicone rubber heaters can be thermally insulated with silicone sponge rubber bonded to one side in the following thicknesses: 1/16, 1/8, 1/4, 3/8 or 1/2 in. (1.6, 3.2, 6, 9.5 or 13 mm).

An aluminized surface can be added to the back side of the heater to reduce radiated heat losses. This aluminized surface, called "low loss treatment," adds very little to the unit thickness or mass and maintains a very clean appearance.

Flexible Heaters

Silicone Rubber Heaters

Applications and Technical Data

Determining Watt Density

The *Maximum Allowable Watt Density* graph illustrates the maximum recommended heater watt density at various metal parts or ambient air temperatures. However, it does not indicate the watt density necessary to achieve a given part temperature. See the *Surface Temperature vs. Time* graph on the next page for assistance with these calculations. When using this graph, consider:

- Part temperature is measured at the point where the heater contacts the metal part.
- Thermostats and on-off controllers are typically bimetal or capillary bulb.
- Non-cycling controllers are typically solid state, time-proportioning or silicone controlled rectifier (SCR) temperature controllers.

- Watt density values should be de-rated by one third if insulation is used.
- UL® recognition temperature limits are not detailed.
- Contact your Watlow representative prior to selecting high watt density etched-foil elements, or operating heaters with back side insulation or non-metallic parts which are poor thermal conductors.

Example: A wire-wound heater with a non-cycling controller at a part temperature of 250°F (120°C) can be rated at 24 W/in² (3.7 W/cm²) maximum. An etched foil heater operating under the same conditions can be rated at 45 W/in² (7 W/cm²) maximum.

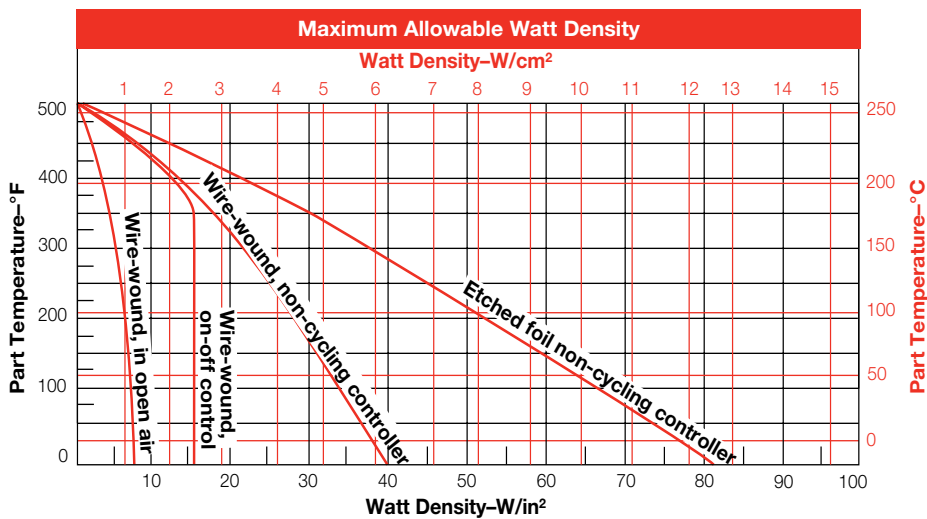

Silicone Rubber Specifications

Max. width x max. length

- Wire wound: 36 x 120 in. (914 mm x 3048 mm)
- Etched foil: 18 x 34 in. (457 mm x 863 mm)

Thickness

- Wire wound: 0.055 in. (1.4 mm)
- Etched foil: 0.022 in. (0.6 mm)

Weight

- Wire wound: 8 oz/ft² (0.24 g/cm²)
- Etched foil: 3 oz/ft² (0.09 g/cm²)

Max. operating temperature: 500°F (260°C)

Max. temperature for UL® recognition: 428°F (220°C)

Min. ambient temperature: -80°F (-62°C)

Max. voltage: 600V

Max. wattage: see watt density graph

Lead size: sized to load

Lead length: 12 +1/2 -1/2 in. (305 mm +38 mm -13 mm)

Wattage tolerance

- Wire: ±5%
- Foil: +5% -10%

Dimensional tolerances

- 0 to 6 in. (0 to 152 mm): ±1/16 in. (1.59 mm)
- 6 to 18 in. (152 to 457 mm): ±1/8 in. (3.18 mm)
- 18 to 36 in. (457 mm to 914 mm): ±3/16 in. (4.76 mm)
- Over 36 in. (914 mm): ±1%

Flexible Heaters

Silicone Rubber Heaters

Applications and Technical Data (Continued)

Surface Temperature vs. Time

This graph illustrates the surface temperature a silicone rubber heater will reach when uninsulated and suspended vertically in 70°F (20°C) still air.

Data is based on 0.055 in. (1.4 mm) thick construction and is offered as a reference tool.

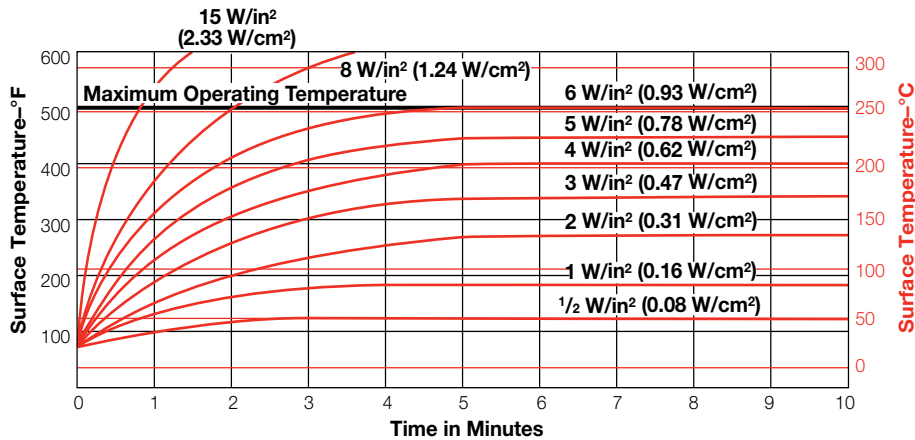

UR®, cUR®, VDE and CE Recognition for Silicone Rubber Heaters

Watlow frequently works with customers requiring agency approvals such as UR®, cUR®, VDE and CE. Many silicone rubber heaters are available with one or more certifications.



UL® Component Recognition (UR®) of factory-bonded heaters is available up to 392°F (200°C) and for customer installed heaters up to 428°F (220°C) (UL® File No. E52951).

For Canadian recognition, Watlow offers **cUR® Recognized** silicone rubber heaters under UL® File #E52951. Several constructions are available with ratings to 600V and 428°F (220°C) maximum surface temperature. Contact your Watlow representative for further information.

VDE Approval is available on several constructions of both wire-wound (File No. 62533) and etched foil (File No. 62535) silicone rubber heaters. Maximum ratings are 440V and 428°F (220°C) surface temperature. Under VDE guidelines, minimum installed bend radius is 1/8 in. (3.2 mm) for etched foil and 1/4 in. (6 mm) for wire wound. VDE states that the user is responsible for the safe application, installation and wiring of heaters. Maximum working temperature must be maintained by an appropriate temperature controller.

The **CE mark** is available on UR® and/or VDE recognized heaters.

Options

Watlow offers options including attachment techniques, thermostats, special leads, holes and cutouts and three-dimensional shapes as described in the introduction to flexible heaters section.

Extended Capabilities For Silicone Rubber Heaters

Mounting Methods

Factory Bonding

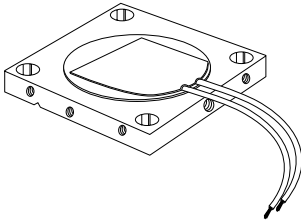

This attachment technique provides a strong, void-free bond for excellent heat transfer and extended heater life that has proven to be successful. Bonding is recommended for applications that reach maximum temperatures of 500°F (260°C) on silicone rubber and 300°F (150°C) on polyimide.

Termination Styles

HPN Cord and Plug Set

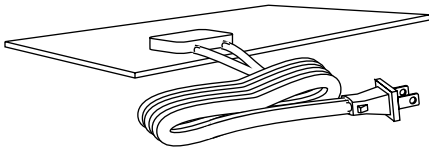

**Molded Leads are Shown Exiting Edge of Heater;
Capped Leads are also Available.**

For removable heaters, a 6 ft (1.8 m) HPN cord and plug set provides convenience. It is rated for 194°F (90°C)/300V. An HPN cord without a plug is also available in any length.

Construction

Formed Heaters

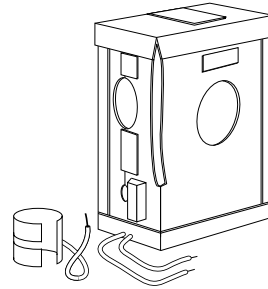

Many three-dimensional shapes, such as cylinders, cones and boxes, can be factory formed. Semi-rigid shapes can self-grip to the part. Special tooling may be required for some designs.

Holes, Cutouts and Notches

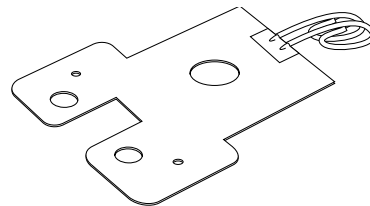

Watlow provides flexible heaters with special holes, cutouts and notches in nearly any position required for your design. The resistance element can be brought to within 1/8 in. (3.2 mm) of all edges. Standard spacing is 1/4 in. (6 mm) from all edges.

Flexible Heaters

Silicone Rubber Heaters

Wire-Wound Elements – RAPID SHIP Offering

Width		Length		Watts	120VAC	120/240VAC
in.	(mm)	in.	(mm)		Part Number	Part Number
1	(25)	2	(51)	10	010020C1*	
		3	(76)	15	010030C1*	
		4	(102)	20	010040C1*	
		5	(127)	25	010050C1*	
		5	(127)	6.25/25		010050C2*
		10	(254)	50	010100C1	
		10	(254)	12.50/50		010100C2*
		15	(381)	75	010150C1	
		15	(381)	18.75/75		010150C2
		20	(508)	100	010200C1	
		20	(508)	25/100		010200C2
		25	(635)	125	010250C1	
		30	(762)	150	010300C1	
		35	(889)	175	010350C1	
		40	(1016)	200	010400C1	
80	(2032)	400	010800C1			
120	(3048)	600	010F10C1			
2	(51)	2	(51)	20	020020C1*	
		5	(127)	50	020050C1	
		5	(127)	12.50/50		020050C2*
		10	(254)	100	020100C1	
		10	(254)	25/100		020100C2
		15	(381)	150	020150C1	
		15	(381)	37.50/150		020150C2
		20	(508)	200	020200C1	
		20	(508)	50/200		020200C2
		25	(635)	250	020250C1	
		30	(762)	300	020300C1	
		35	(889)	350	020350C1	
		40	(1016)	400	020400C1	
3	(76)	3	(76)	45	030030C1	
		5	(127)	75	030050C1	
		5	(127)	18.75/75		030050C2
		10	(254)	150	030100C1	
		10	(254)	37.50/150		030100C2
		15	(381)	225	030150C1	
		15	(381)	56.25/225		030150C2
		20	(508)	300	030200C1	
		20	(508)	75/300		030200C2
		25	(635)	375	030250C1	
		30	(762)	450	030300C1	
		35	(889)	525	030350C1	
		40	(1016)	600	030400C1	

CONTINUED

RAPID SHIP

- **RS** - Next day shipment up to 10 pieces for orders with part number configuration -0001B.

* Due to their high resistance, these heaters are not recommended for curved or flexing applications.

Notes:

- Thickness 0.055 in. (1.4 mm)
- Heaters have lead length of 12 in. (305 mm) UL® 1180 PTFE
- UL® component recognition
- Silicone rubber wire-wound elements rated at 5 W/in² (0.78 W/cm²)

Flexible Heaters

Silicone Rubber Heaters

Wire-Wound Elements – RAPID SHIP Offering (Continued)

Width		Length		Watts	120VAC Part Number	120/240VAC Part Number
in.	(mm)	in.	(mm)			
4	(102)	4	(102)	80	040040C1	
		5	(127)	100	040050C1	
		5	(127)	25/100		040050C2
		10	(254)	200	040100C1	
		10	(254)	50/200		040100C2
		15	(381)	300	040150C1	
		15	(381)	75/300		040150C2
		20	(508)	400	040200C1	
		20	(508)	100/400		040200C2
		25	(635)	500	040250C1	
		30	(762)	600	040300C1	
35	(889)	700	040350C1			
40	(1016)	800	040400C1			
5	(127)	5	(127)	125	050050C1	
		5	(127)	31.25/125		050050C2
		10	(254)	250	050100C1	
		10	(254)	62.50/250		050100C2
		15	(381)	375	050150C1	
		15	(381)	9.38/375		050150C2
		20	(508)	500	050200C1	
		20	(508)	125/500		050200C2
		25	(635)	625	050250C1	
		30	(762)	750	050300C1	
		35	(889)	875	050350C1	
40	(1016)	1000	050400C1			
6	(152)	5	(127)	150	060050C1	
		5	(127)	37.50/150		060050C2
		10	(254)	300	060100C1	
		10	(254)	75/300		060100C2
		15	(381)	450	060150C1	
		15	(381)	112.50/450		060150C2
		20	(508)	600	060200C1	
		20	(508)	150/600		060200C2
		25	(635)	750	060250C1	
		30	(762)	900	060300C1	
		35	(889)	1050	060350C1	
40	(1016)	1200	060400C1			

RAPID SHIP

- **RS** - Next day shipment up to 10 pieces for orders with part number configuration -0001B.

* Due to their high resistance, these heaters are not recommended for curved or flexing applications.

Notes:

- Thickness 0.055 in. (1.4 mm)
- Heaters have lead length of 12 in. (305 mm) UL® 1180 PTFE
- UL® component recognition
- Silicone rubber wire-wound elements rated at 5 W/in² (0.78 W/cm²)

Flexible Heaters

Silicone Rubber Heaters

Wire-Wound Elements – RAPID SHIP Offering Coding Configured Options

To order, complete the part number with the information below:

Wire Wound

0 - - - - - - - - - - -

Modification Options
0 = None
A = PSAS bottom
B = PSAS top
E = With plate, heater on side opposite flange
F = With plate, heater on flange side
G = Flaps + grommets
H = Flaps + boot hooks
J = Flaps + latch fasteners
K = PSAS and low loss
L = Low loss
M = Low loss + flaps + grommets
N = Low loss + flaps + boot hooks
P = Low loss + flaps + latch fasteners
R = 1/16 in. sponge
S = 1/8 in. sponge
T = 1/4 in. sponge
U = 3/8 in. sponge
V = 1/2 in. sponge
W = PSAS + 1/16 in. sponge
Y = PSAS + 1/8 in. sponge
1 = PSAS + 1/4 in. sponge
2 = PSAS + 3/8 in. sponge
3 = PSAS + 1/2 in. sponge

Sensors Type	LOC	WIR
0 = None		
L = T10	STD	STD
M = T10	STD	ALT
N = T10	ALT	STD
P = T10	ALT	ALT
R = T207	STD	STD
S = T207	STD	ALT
T = T207	ALT	STD
U = T207	ALT	ALT
V = T207E	On heater	STD
W = T207E	Remote	STD
4 = JSTD	STD	STD
6 = JALT	STD	STD
7 = KSTD	STD	STD

- For thermostats, standard location is as shown in catalog; standard wiring is integral or in series with the heater, alternate location is rotated parallel with heater width, alternate wiring is separate leads for pilot control.

- For thermocouples, Type J standard is PFA insulation, Type J alternate is fiberglass insulation, Type K standard is fiberglass insulation.

T10 Set °F*
0 = None
A = 125
B = 150
E = 175
F = 200
G = 225
H = 250
J = 275
K = 300

T207 Set °F*
0 = None
1 = 40/55
2 = 60/75
3 = 95/110
4 = 145/160

T/C Length
0 = None
A = 8 in.
B = 12 in.
E = 18 in.
F = 24 in.
G = 30 in.
H = 36 in.
J = 40 in.
K = 4 ft
L = 5 ft
M = 6 ft
N = 7 ft
P = 8 ft
R = 9 ft
S = 10 ft
T = 12 ft
U = 15 ft
V = 18 ft
W = 20 ft
Y = 22 ft
1 = 25 ft
2 = 30 ft

* For all thermostats the heater must be a 2 in. (51 mm) min. width and 5 in. (127 mm) min. length.

Lead Insulation
0 = None
1 = 1180 UL®R/C
2 = 1180 C-UL®R/C
3 = 3133 22 Ga.
6 = 1199 CSA
7 = HPN
8 = 6 ft HPN set
9 = Type E PTFE
A = 1180VDE*
B = 1199VDE*
C = Silicone leads w/waterproof cap
E = SJO cord
F = 6 ft SJO set

* 1180VDE denotes a C-UL® heater plus a VDE stamp.

Lead Length*
A = 8 in.
B = 12 in.
E = 18 in.
F = 24 in.
G = 30 in.
H = 36 in.
J = 40 in.
K = 4 ft
L = 5 ft
M = 6 ft
N = 7 ft
P = 8 ft
R = 9 ft
S = 10 ft
T = 12 ft
U = 15 ft
V = 18 ft
W = 20 ft
Y = 22 ft
1 = 25 ft
2 = 30 ft

* Customer specified length must be noted in inches when ordering.

Flexible Heaters

Silicone Rubber Heaters

Etched Foil Elements – RAPID SHIP Offering

Width in. (mm)	Length in. (mm)	Watts	W/in ² (W/cm ²)	120VAC Part Number	120/240VAC Part Number	
1 (25)	5 (127)	25	5 (0.8)	F010050C3		
	5 (127)	50	10 (1.6)	F010050C7		
	5 (127)	12.5/50	2.5/10 (0.4/1.6)			F010050C8
	10 (254)	100	10 (1.6)	F010100C7		
	10 (254)	25/100	2.5/10 (0.4/1.6)			F010100C8
	15 (381)	150	10 (1.6)	F010150C7		
	15 (381)	37.5/150	2.5/10 (0.4/1.6)			F010150C8
	20 (508)	200	10 (1.6)	F010200C7		
20 (508)	50/200	2.5/10 (0.4/1.6)		F010200C8		
2 (51)	5 (127)	100	10 (1.6)	F020050C7		
	5 (127)	25/100	2.5 /10 (0.4/1.6)			F020050C8
	10 (254)	200	10 (1.6)	F020100C7		
	10 (254)	50/200	2.5 /10 (0.4/1.6)			F020100C8
	15 (381)	300	10 (1.6)	F020150C7		
	15 (381)	75/300	2.5/10 (0.4/1.6)		F020150C8	
	20 (508)	400	10 (1.6)	F020200C7		
20 (508)	100/400	2.5/10 (0.4/1.6)		F020200C8		
3 (76)	5 (127)	75	5 (0.8)	F030050C3		
	5 (127)	150	10 (1.6)	F030050C7		
	5 (127))	37.5/150	2.5 /10 (0.4/1.6)			F030050C8
	10 (254)	300	10 (1.6)	F030100C7		
	10 (254)	75/300	2.5 /10 (0.4/1.6)			F030100C8
	15 (381)	450	10 (1.6)	F030150C7		
	15 (381)	112/450	2.5 /10 (0.4/1.6)			F030150C8
	20 (508)	600	10 (1.6)	F030200C7		
20 (508)	150/600	2.5 /10 (0.4/1.6)		F030200C8		
4 (102)	5 (127)	200	10 (1.6)	F040050C7		
	5 (127)	50/200	2.5 /10 (0.4/1.6)			F040050C8
	10 (254)	400	10 (1.6)	F040100C7		
	10 (254)	100/400	2.5 /10 (0.4/1.6)			F040100C8
	15 (381)	600	10 (1.6)	F040150C7		
	15 (381)	150/600	2.5/10 (0.4/1.6)		F040150C8	
	20 (508)	800	10 (1.6)	F040200C7		
20 (508)	200/800	2.5/10 (0.4/1.6)		F040200C8		
5 (127)	5 (127)	250	10 (1.6)	F050050C7		
	5 (127)	62.5/250	2.5/10 (0.4/1.6)			F050050C8
	10 (254)	500	10 (1.6)	F050100C7		
	10 (254)	125/500	2.5/10 (0.4/1.6)			F050100C8
	15 (381)	750	10 (1.6)	F050150C7		
	15 (381)	187/750	2.5/10 (0.4/1.6)		F050150C8	
	20 (508)	1000	10 (1.6)	F050200C7		
20 (508)	250/1000	2.5/10 (0.4/1.6)		F050200C8		
6 (152)	5 (127)	300	10 (1.6)	F060050C7		
	5 (127)	75/300	2.5/10 (0.4/1.6)			F060050C8
	10 (254)	600	10 (1.6)	F060100C7		
	10 (254)	150/600	2.5 /10 (0.4/1.6)			F060100C8
	15 (381)	900	10 (1.6)	F060150C7		
	15 (381)	225/900	2.5/10 (0.4/1.6)		F060150C8	
	20 (508)	1200	10 (1.6)	F060200C7		
20 (508)	300/1200	2.5/10 (0.4/1.6)		F060200C8		

RAPID SHIP

• RS - Next day shipment up to 10 pieces for orders with part number configuration 0001B.

Notes:

- Silicone rubber etched foil elements 0.022 in. (0.56 mm) thick
- Heaters have standard lead length of 12 in. (305 mm) UL® 1180 PTFE
- UL® component recognition

Flexible Heaters

Silicone Rubber Heaters

Etched Foil Elements – RAPID SHIP Offering Coding Configured Options

To order, complete the part number with the information below:

Etched Foil
F0 -

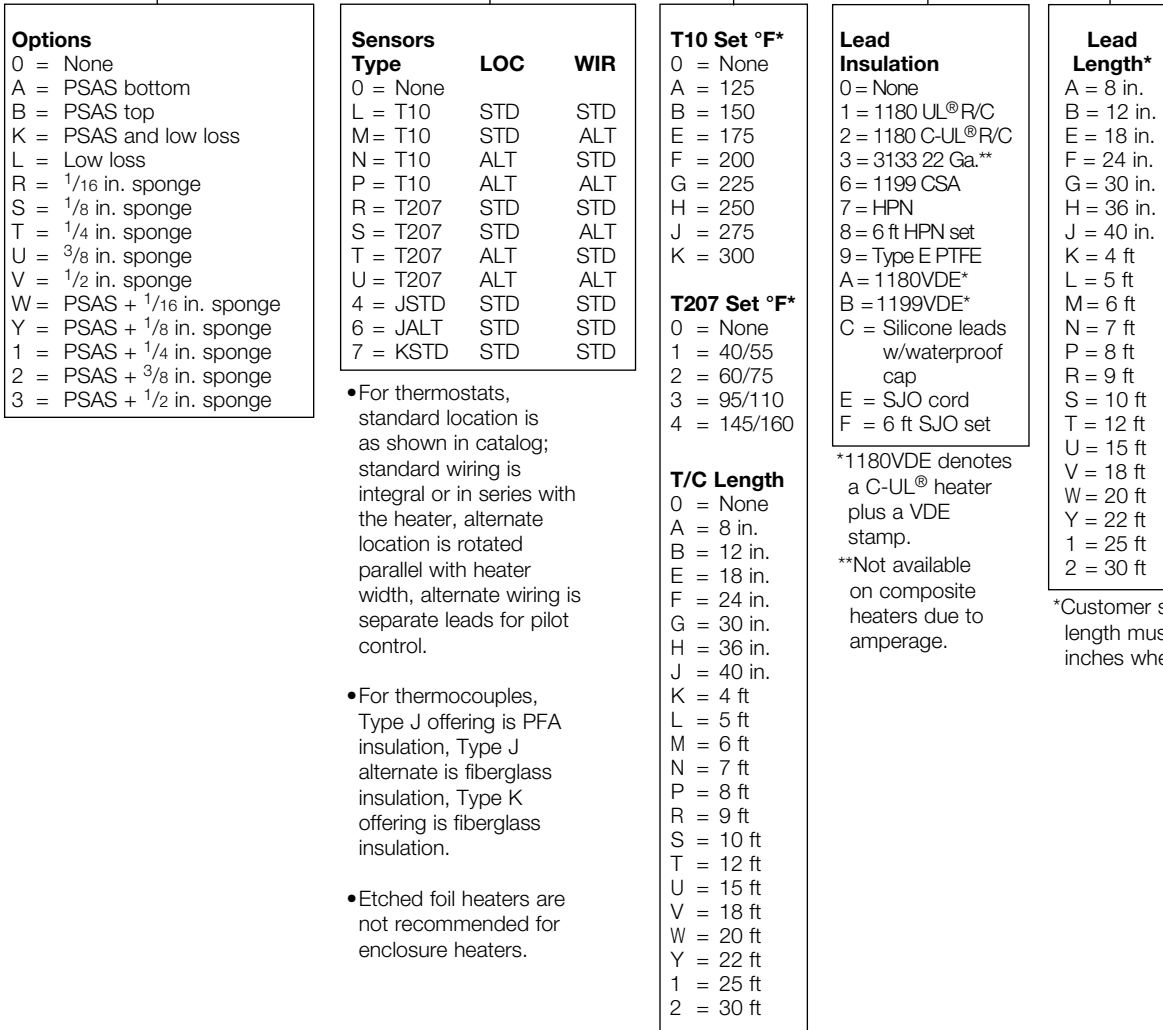

- For thermostats, standard location is as shown in catalog; standard wiring is integral or in series with the heater, alternate location is rotated parallel with heater width, alternate wiring is separate leads for pilot control.

- For thermocouples, Type J offering is PFA insulation, Type J alternate is fiberglass insulation, Type K offering is fiberglass insulation.

- Etched foil heaters are not recommended for enclosure heaters.

*1180VDE denotes a C-UL® heater plus a VDE stamp.

**Not available on composite heaters due to amperage.

*Customer specified length must be noted in inches when ordering.

*For all thermostats, the heater must be a 2 in. min. width and a 5 in. min. length.

Flexible Heaters

Silicone Rubber Heaters

Composite Bonding Applications

Watlow offers silicone rubber heaters commonly used for composite bonding and curing. The design includes equal length circuits and a no-heat tab for temperature uniformity. The contact surface is made using smooth silicone to prevent composite surface imperfections. The heaters are fiberglass reinforced to provide lasting field service durability and life.

Performance Capabilities

- Watt density up to 5 W/in² (0.8 W/cm²)
- Voltage of 120VAC/240VAC (option) single phase
- UL® recognized

Features and Benefits

Customized leads

- Allows up to 30 feet of lead length

Field service ease

- Enables on-site repairs

Equal length circuits — min. 2 x 2 in. (51 x 51 mm) tab with radius

- Creates temperature uniformity

Smooth contact surface

- Prevents composite surface imperfections

Typical Applications

- Aerospace industry
 - Repair
 - Fabrication
- Composite bonding processes



Flexible Heaters

Silicone Rubber Heaters

Wire-Wound Elements – Composite Bonding Applications

Composite Heaters “L”

Width		Length		Watts	120VAC	120/240VAC
in.	(mm)	in.	(mm)		Part Number	Part Number
6	(152)	6	(152)	180	L060080C1	
		6	(152)	180		L060080C2
		10	(254)	300	L060120C1	
		10	(254)	300		L060120C2
8	(203)	8	(203)	320	L080100C1	
		8	(203)	320		L080100C2
		12	(305)	480	L080140C1	
		12	(305)	480		L080140C2
10	(254)	10	(254)	500	L100120C1	
		10	(254)	500		L100120C2
		12	(305)	600	L100140C1	
		12	(305)	600		L100140C2
		18	(457)	900	L100200C1**	
		18	(457)	900		L100200C2
12	(305)	12	(305)	720	L120140C1**	
		12	(305)	720		L120140C2
		18	(457)	1080	L120200C1**	
		18	(457)	1080		L120200C2**
		24	(610)	1440	L120260C1**	
24	(610)	1440		L120260C2**		
16	(406)	16	(406)	1280	L160180C1**	
		16	(406)	1280		L160180C2**
18	(457)	18	(457)	1620	L180200C1**	
		18	(457)	1620		L180200C2**
20	(508)	20	(508)	2000	L200220C1*	
		20	(508)	2000		L200220C2**

• **M** - Manufacturing lead times

Notes:

- Thickness 0.055 in. (1.4 mm)
- Lead length 12 in. (305 mm) UL® 1180 PTFE
- UL® component recognition
- Silicone rubber wire-wound elements rated at 5 W/in²
- Length does not include 2 in. (51 mm) tab for leads
- Smooth surface

* **Thermostat option is not available for this heater.**

** **Only T207 thermostat option is available.**

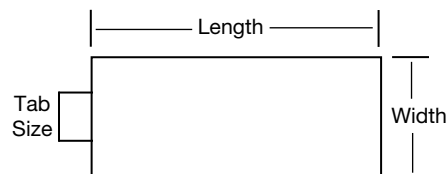

Flexible Heaters

Silicone Rubber Heaters

Etched Foil Elements — Coding Configured Options Composite Heaters “L”

To order, complete the part number with the information below:

Composite Flexible Stock Heaters

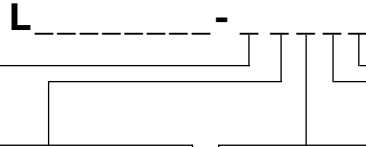

Modification Options
0 = None
A = PSAS bottom
B = PSAS top
K = PSAS and low loss
L = Low loss
R = 1/16 in. sponge
S = 1/8 in. sponge
T = 1/4 in. sponge
U = 3/8 in. sponge
V = 1/2 in. sponge
W = PSAS + 1/16 in. sponge
Y = PSAS + 1/8 in. sponge
1 = PSAS + 1/4 in. sponge
2 = PSAS + 3/8 in. sponge
3 = PSAS + 1/2 in. sponge

Sensors Type	LOC	WIR
0 = None		
L = T10	STD	STD
M = T10	STD	ALT
N = T10	ALT	STD
P = T10	ALT	ALT
R = T207	STD	STD
S = T207	STD	ALT
T = T207	ALT	STD
U = T207	ALT	ALT
4 = JSTD	STD	STD
6 = JALT	STD	STD
7 = KSTD	STD	ST

- For thermostats, standard location is as shown in catalog; standard wiring is integral or in series with the heater, alternate location is rotated parallel with heater width, alternate wiring is separate leads for pilot control.

- For thermocouples, Type J offering is PFA insulation, Type J alternate is fiberglass insulation, Type K offering is fiberglass insulation.

- Etched foil heaters are not recommended for enclosure heaters.

T10 Set °F*
0 = None
A = 125
B = 150
E = 175
F = 200
G = 225
H = 250
J = 275
K = 300

T207 Set °F*
0 = None
1 = 40/55
2 = 60/75
3 = 95/110
4 = 145/160

T/C Length
0 = None
A = 8 in.
B = 12 in.
E = 18 in.
F = 24 in.
G = 30 in.
H = 36 in.
J = 40 in.
K = 4 ft
L = 5 ft
M = 6 ft
N = 7 ft
P = 8 ft
R = 9 ft
S = 10 ft
T = 12 ft
U = 15 ft
V = 18 ft
W = 20 ft
Y = 22 ft
1 = 25 ft
2 = 30 ft

Lead Insulation
0 = None
1 = 1180 UL®R/C
2 = 1180 C-UL®R/C
3 = 3133 22 Ga.**
6 = 1199 CSA
7 = HPN
8 = 6 ft HPN set
9 = Type E PTFE
A = 1180VDE*
B = 1199VDE*
C = Silicone leads w/waterproof cap
E = SJO cord
F = 6 ft SJO set

* 1180VDE denotes a cUR® heater plus a VDE stamp.

**Not available on composite heaters due to amperage.

Lead Length*
A = 8 in.
B = 12 in.
E = 18 in.
F = 24 in.
G = 30 in.
H = 36 in.
J = 40 in.
K = 4 ft
L = 5 ft
M = 6 ft
N = 7 ft
P = 8 ft
R = 9 ft
S = 10 ft
T = 12 ft
U = 15 ft
V = 18 ft
W = 20 ft
Y = 22 ft
1 = 25 ft
2 = 30 ft

* Customer specified length must be noted in inches when ordering.

Flexible Heaters

Line Heating

Modular Gas Line Heaters

Gas Delivery

Tetraethyl orthosilicate (TEOS), boron trichloride (BCl_3), aluminum chloride (AlCl_3), chlorine trifluoride (ClF_3) and dichlorosilane (DCS) are gases that condense or liquefy due to a phase shift at low temperatures. In semiconductor processes, condensation occurs in the gas line and puddles in the shower head before being injected into the vacuum chamber. A substantial number of wafer defects will occur if liquefied gases are injected into the vacuum chamber. Uniform heating of the lines will prevent condensation. TEOS lines are typically heated above 194°F (90°C) and BCl_3 above 86°F (30°C), depending on pressure and flow rate. The optimum line temperature will vary depending on the process parameters.

Specifications

- Watt density of 2.5 W/in² (0.4 W/cm²) on gas line O.D.
- UL[®] recognized for U.S. and Canadian safety standards
- Heaters and insulators meet UL[®] 94-HB flammability requirements
- Insulated straight fillers for 100 percent line coverage; elbows and tees are trim-to-fit to proper length
- I.D. available: 1/4, 3/8, 1/2, 3/4 in. (6, 9.5, 13, 19 mm)
- 120V standard, other voltages available
- Small metal snaps
- Heaters are insulated with a 3/8 in. (9.5 mm) wall, silicone rubber, closed cell sponge

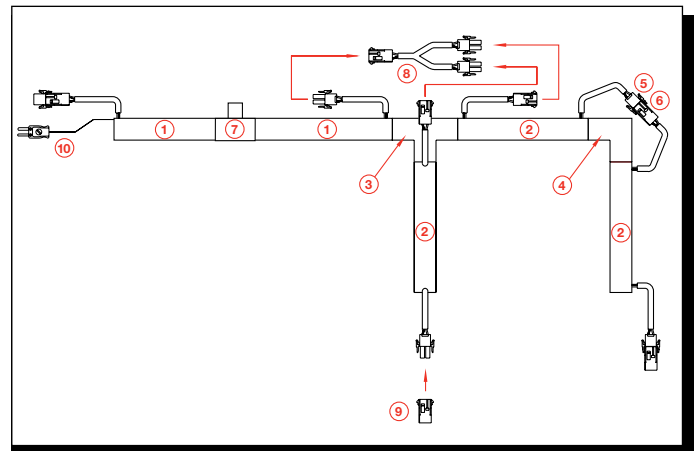
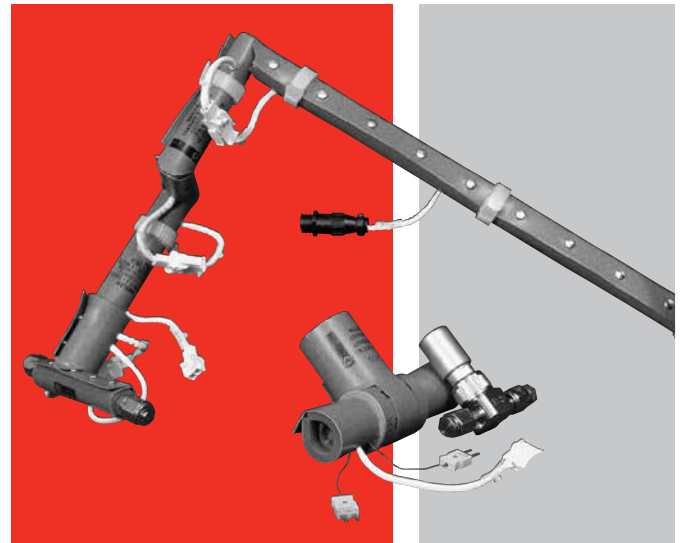

Upstream Gas Line Heater Assembly (Example)

- ① 9 in. (229 mm) heater with thermocouple. Heater leads have a male plug on one end and a female cap on the other end. Heater materials are UL[®] rated to 392°F (200°C)
- ② 6 in. (152 mm) heater, heater leads, see 1
- ③ Union tee insulator
- ④ 90° union elbow insulator
- ⑤ Male plug, AMP MATE-N-LOK[™] connector part number 1-480698-0; with sockets AMP MATE-N-LOK[™] connector part number 350689-1
- ⑥ Female cap, AMP MATE-N-LOK[™] connector part number 1-480699-0; with pins AMP MATE-N-LOK[™] connector part number 350690-1
- ⑦ Valve or regulator
- ⑧ Y connector: one female cap on one end, two male plugs on the other end
- ⑨ Dead plug (sealed)
- ⑩ Type J thermocouple w/ male mini-plug (optional)

Flexible Heaters

Line Heating

Modular Gas Line Heaters (Continued)

Gas Line Diameter

1/4 in. (6 mm) O.D. Tubing

1/4 in. (6 mm) Heater I.D. x Length in. (mm)	Description	Volts	Watts	Amperes	Part Number		
					Without T/C	With Type J T/C	With Type K T/C
6 (152)	Heated straight	120	12	0.10	008060C1	008060C1A	008060C1K
9 (229)	Heated straight	120	18	0.15	008090C1	008090C1A	008090C1K
12 (305)	Heated straight	120	24	0.20	008120C1	008120C1A	008120C1K
18 (457)	Heated straight	120	36	0.30	008180C1	008180C1A	008180C1K
24 (610)	Heated straight	120	48	0.40	008240C1	008240C1A	008240C1K
36 (914)	Heated straight	120	72	0.60	008360C1	008360C1A	008360C1K
18 (457)	Straight insulator	N/A	Trim-to-fit	Insulator	008180C0		
* Elbow	90° union elbow insulator	N/A	Trim-to-fit	Insulator	008020C0		
* Tee	Union tee insulator	N/A	Trim-to-fit	Insulator	008030C0		

3/8 in. (10 mm) O.D. Tubing

3/8 in. (10 mm) Heater I.D. x Length in. (mm)	Description	Volts	Watts	Amperes	Part Number		
					Without T/C	With Type J T/C	With Type K T/C
6 (152)	Heated straight	120	18	0.15	012060C1	012060C1A	012060C1K
9 (229)	Heated straight	120	27	0.23	012090C1	012090C1A	012090C1K
12 (305)	Heated straight	120	36	0.30	012120C1	012120C1A	012120C1K
18 (457)	Heated straight	120	54	0.45	012180C1	012180C1A	012180C1K
24 (610)	Heated straight	120	71	0.60	012240C1	012240C1A	012240C1K
36 (914)	Heated straight	120	107	0.90	012360C1	012360C1A	012360C1K
18 (457)	Straight insulator	N/A	Trim-to-fit	Insulator	012180C0		
* Elbow	90° union elbow insulator	N/A	Trim-to-fit	Insulator	012020C0		
* Tee	Union tee insulator	N/A	Trim-to-fit	Insulator	012030C0		

1/2 in. (13 mm) O.D. Tubing

1/2 in. (13 mm) Heater I.D. x Length in. (mm)	Description	Volts	Watts	Amperes	Part Number		
					Without T/C	With Type J T/C	With Type K T/C
6 (152)	Heated straight	120	24	0.20	016060C1	016060C1A	016060C1K
9 (229)	Heated straight	120	36	0.30	016090C1	016090C1A	016090C1K
12 (305)	Heated straight	120	48	0.40	016120C1	016120C1A	016120C1K
18 (457)	Heated straight	120	72	0.60	016180C1	016180C1A	016180C1K
24 (610)	Heated straight	120	96	0.80	016240C1	016240C1A	016240C1K
36 (914)	Heated straight	120	144	1.20	016360C1	016360C1A	016360C1K
18 (457)	Straight insulator	N/A	Trim-to-fit	Insulator	016180C0		
* Elbow	90° union elbow insulator	N/A	Trim-to-fit	Insulator	016020C0		
* Tee	Union tee insulator	N/A	Trim-to-fit	Insulator	016030C0		

• M - Manufacturing lead times

* For use on Micro-Fit® weld fittings.

Flexible Heaters

Line Heating

Modular Gas Line Heaters (Continued)

Gas Line Diameter

3/4 in. (19 mm) O.D. Tubing

3/4 in. (19 mm) Heater I.D. x Length in. (mm)	Description	Volts	Watts	Amperes	Part Number		
					Without T/C	With Type J T/C	With Type K T/C
6 (152)	Heated straight	120	36	0.30	024060C1	024060C1A	024060C1K
9 (229)	Heated straight	120	54	0.45	024090C1	024090C1A	024090C1K
12 (305)	Heated straight	120	71	0.60	024120C1	024120C1A	024120C1K
18 (457)	Heated straight	120	107	0.90	024180C1	024180C1A	024180C1K
24 (610)	Heated straight	120	142	1.19	024240C1	024240C1A	024240C1K
36 (914)	Heated straight	120	213	1.78	024360C1	024360C1A	024360C1K
18 (457)	Straight insulator	N/A	Trim-to-fit	Insulator	024180C0		
* Elbow	90° union elbow insulator	N/A	Trim-to-fit	Insulator	024020C0		
* Tee	Union tee insulator	N/A	Trim-to-fit	Insulator	024030C0		

• **M** - Manufacturing lead times

* For use on Micro-Fit® weld fittings.

VCR Union Heaters/Insulators

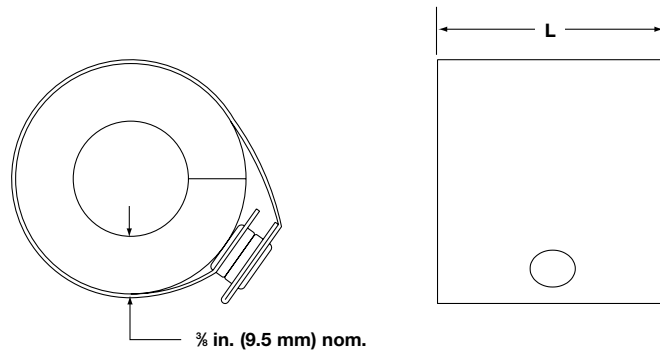

1/4 in. (6 mm) Heater I.D. x Length in. (mm)	Description	Volts	Watts	Amperes	Part Number		
					Without T/C	With Type J T/C	With Type K T/C
7/8 x 1 3/4 (22 x 45)	1/4 in. (6 mm) VCR union heater	120	10	0.09	01702783	01702783A	01702783K
3/4 x 1 1/2 (19 x 38)	1/4 in. (6 mm) VCR union insulator	N/A	N/A	N/A	02401580	N/A	N/A
1 1/4 x 1 1/2 (32 x 38)	1/2 in. (13 mm) VCR union heater	120	12	0.10	03901581	03901581A	03901581K
1 1/4 x 1 1/2 (32 x 38)	1/2 in. (13 mm) VCR union insulator	N/A	N/A	N/A	03901580	N/A	N/A

• **M** - Manufacturing lead times

Flexible Heaters

Line Heating

Modular Gas Line Heaters (Continued)

VCR Valve Heaters

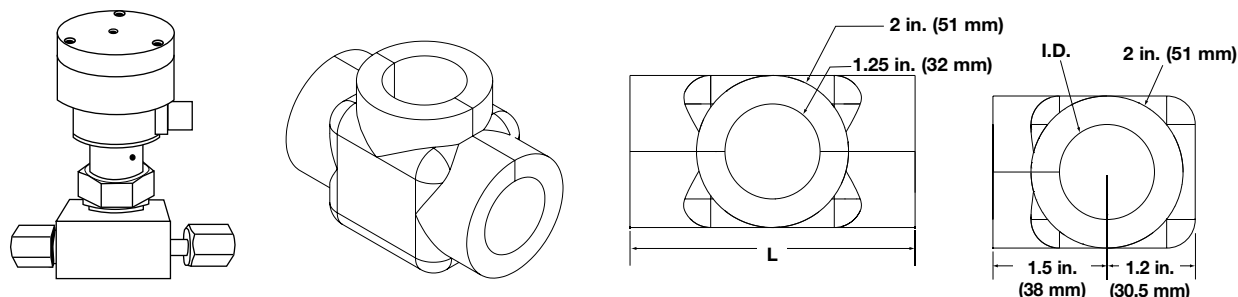

Tube Diameter in.	(mm)	I.D. in.	(mm)	Fitting Type	Length in.	(mm)	Watts	Amperes @ 120V	Part Number
1/4	(6)	7/8	(22)	Male VCR valve heater	3.00	(76)	18	0.15	03104786
1/4	(6)	7/8	(22)	Female VCR valve heater	4.75	(121)	28	0.24	04704893
1/2	(13)	1 1/4	(32)	Male VCR valve heater	3.75	(95)	27	0.23	03804782
1/2	(13)	1 1/4	(32)	Female VCR valve heater	6.51	(165)	47	0.39	04706690

• **M** - Manufacturing lead times

Note: Heaters fit Nupro® BN and BK series valves.

Accessories

Part	Description	Part Number
Y connector*	Power splitter: 1 female, 2 male	Z5303-2
Y connector*	Power splitter: 2 female, 1 male	Z6333
Female dead plug*	Insulating plug for last connector in chain	Z5309-2
Male dead plug*	Insulating plug for last connector in chain	Z6332
Type J thermocouple	12 in. (305 mm) 24 Ga. Type J PFA with mini plug	Z5786
Type J thermocouple extension	10 ft (3048 mm) Type K FEP thermocouple with mini plug and mini jack	Z6271
Type K thermocouple	12 in. (305 mm) 24 Ga. Type K TFE tape with mini plug	Z5639
Adapter*	Female to male	Z6334
Adapter*	Male to female	Z6335
Power extension*	6 in. (152 mm)	Z6374
Power extension*	3 ft (914 mm)	A000136
Power extension*	6 ft (1829 mm)	A000137
Power extension*	10 ft (3048 mm)	A000138
Strap extension	1 in. (25 mm) long pump line strap extension	010010116
Strap extension	2 in. (51 mm) long pump line strap extension	010020113
Strap extension	3 in. (76 mm) long pump line strap extension	010030124

*All connectors use AMP MATE-N-LOK™ connectors.

- Y-adapters and dead plugs
- Sensor pocket thermocouple: 12 in. (305 mm) long, Type J or K, #24 AWG
- Two-prong mini-plug connector

Flexible Heaters

Line Heating

STRETCH-TO-LENGTH® Heaters

During semiconductor processes, condensation of many critical gases occurs due to a phase shift at low temperatures. Burning of gases occurs if the delivery line is too hot. High or low temperature conditions may result in undesirable particulates, costly device defects and tool maintenance.

The Watlow STRETCH-TO-LENGTH® (S-T-L) gas line heater system is an easy-to-assemble temperature solution that delivers superior performance compared to heat tape. The heater's preformed construction allows an engineer to easily wrap it around the delivery line. It provides consistent heater/gas line contact to improve temperature uniformity. Due to its flexibility, the S-T-L gas line heater can compensate for variable component sizes to reduce the potential for hot and cold spots.

The S-T-L system includes a 2 W/in² S-T-L heater and silicone foam rubber insulation.

Features and Benefits

Easy to install two-part system

- Conveniently fits most gas line configurations

Flexible heater design

- Easily customize the thermal profile for each gas line application
- Allows quick prototyping to determine energy distribution requirements for process improvements

Flexible standard system components

- Eliminates unnecessary lead times for custom designs

Agency Certification, Recognition Compliance and Approvals

- Semi S2-93 compatible with a high-limit thermocouple and controller
- UL® recognized for U.S. safety standards

Typical Applications

Gas delivery lines

- Boron trichloride, BCl₃
- Chlorine trifluoride, ClF₃
- Dichlorosilane, (DCS), SiH₂Cl₂
- Tetra ethyl orthosilicate, TEOS
- Tungsten hexafluoride, WF₆
- Process gas line qualification

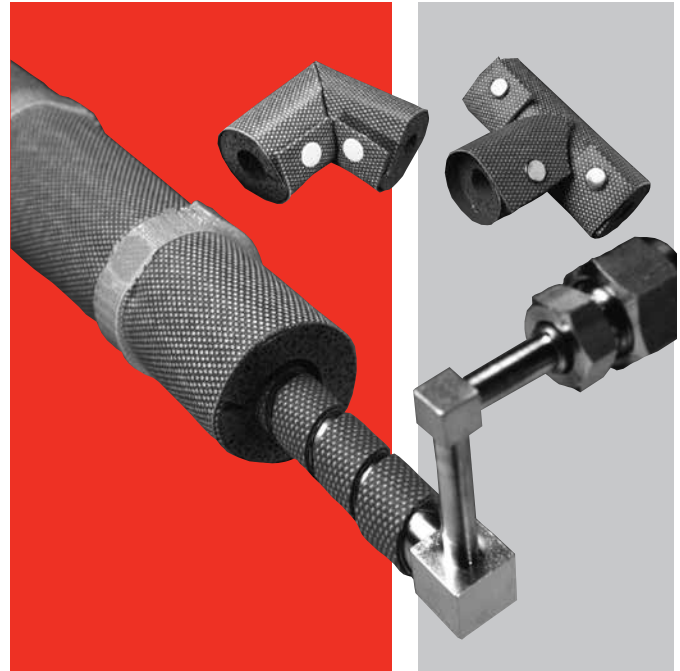

Specifications

- Heater material is reinforced silicone rubber fabric
 - Color:
 - Insulation and outer jacket – orange
 - Heater – orange
- Clean room strap fasteners
- Voltage: 120 and 240VAC
- Max. operating temperature: 392°F (200°C)
- Heater watt density: 2 W/in² (0.31 W/cm²) – Watlow recommends 80% line wrap for optimum performance
- Power lead wires: 12 in. (305 mm); #18 AWG UL® 1180 CSA, rated 10A, lead wire pair encapsulated in reinforced silicone rubber sleeving
- Heater interconnectable up to a 10A circuit
- Material rated UL® 94-HB
- Heater materials are UL® rated to 392°F (200°C)
- Insulation:
 - 3/8 in. (9.5 mm) wall, silicone rubber, closed cell sponge
 - Jacket material is reinforced silicone rubber fabric

Flexible Heaters

Line Heating

STRETCH-TO-LENGTH Heaters (Continued)

S-T-L heaters are specified by their straight length. For actual applications, an engineer can wrap the heaters to achieve an optimum temperature profile. Coverage lengths of approximately 60 and 80 percent on ¼ in. (6 mm) and ½ in. (13 mm) diameter tubes are provided

as a guide to select heater lengths for actual gas line dimensions. A gas line with 100 percent coverage is approximately 2 W/in², 80 percent coverage 1.6 W/in² or 60 percent coverage 1.2 W/in².

S-T-L Heater Ranges - ¼ in. (6 mm) O.D. Tubing

0.25 60% Coverage	0.25 80% Coverage	120V Version Part Number	Amperes	240V Version Part Number	Amperes
10.20	8.04	005120500 ^①	0.10	N/A	N/A
14.45	11.39	005170500 ^②	0.14	N/A	N/A
18.70	14.74	005220500 ^②	0.18	005220501 ^①	0.09
23.80	18.76	005280500 ^①	0.23	005280501 ^①	0.12
30.60	24.12	005360500 ^②	0.30	005360501 ^①	0.15
39.95	31.49	005470500 ^②	0.39	005470501 ^①	0.20
51.00	40.20	005600502 ^②	0.50	005600503 ^①	0.25
63.75	50.25	005750500 ^②	0.63	005750501 ^①	0.31
76.50	60.30	005900500 ^②	0.75	005900501 ^①	0.38

S-T-L Heater Ranges - ½ in. (13 mm) O.D. Tubing

0.50 60% Coverage	0.50 80% Coverage	120V Version Part Number	Amperes	240V Version Part Number	Amperes
10.20	6.63	005170501 ^②	0.14	N/A	N/A
15.00	9.75	005250501 ^②	0.21	N/A	N/A
21.00	13.65	005350502 ^②	0.29	005350503 ^①	0.15
29.40	19.11	005490502 ^②	0.41	005490503 ^②	0.20
38.40	24.96	005640502 ^②	0.53	005640503 ^①	0.27
47.40	30.81	005790502 ^②	0.66	005790503 ^①	0.33
59.40	38.61	005990502 ^②	0.82	005990503 ^②	0.41
73.80	49.97	005F103502 ^②	1.02	005F103503 ^②	0.51
92.40	60.06	005F128502 ^②	1.28	005F128503 ^②	0.64

¼ in. (6 mm) O.D. Tubing Insulators

¼ in. (6 mm) Heater I.D. x Length	Description	Part Number
18 in. (457 mm)	Straight insulator	012180500 ^①
36 in. (914 mm)	Straight insulator	012360500 ^①
Elbow	90° union elbow insulator	012020500 ^①
Tee	Union tee insulator	012030500 ^①
VCR	VCR fitting	015030500 ^①

½ in. (13 mm) O.D. Tubing Insulators

½ in. (13 mm) Heater I.D. x Length	Description	Part Number
18 in. (457 mm)	Straight insulator	024180500 ^①
36 in. (914 mm)	Straight insulator	024360500 ^①
Elbow	90° union elbow insulator	020024500 ^①
Tee	Union tee insulator	024030500 ^①
VCR	VCR fitting	015042500 ^①

¾ in. (9.5 mm) O.D. Tubing Insulators

¾ in. (9.5 mm) Heater I.D. x Length	Description	Part Number
18 in. (457 mm)	Straight insulator	016180500 ^①
36 in. (914 mm)	Straight insulator	016360500 ^①
Elbow	90° union elbow insulator	016020500 ^②
Tee	Union tee insulator	016030501 ^②
VCR	VCR fitting	015042500 ^①

RAPID SHIP

- ① - Next day shipment up to 10 pieces depending on part number
- ② - Manufacturing lead times

Flexible Heaters

Line Heating

STRETCH-TO-LENGTH Heaters (Continued)

Extensions

Description	Part Number
3 ft (914 mm)	A000136
6 ft (1829 mm)	A000137
10 ft (3048 mm)	A000138

Accessories

Description	Part Number
Power cord 6 ft 18-2 SJ	Z5302-2
Wiring Y connector – 1F-2M	Z5303-2
Wiring Y connector – 1M-2F	Z6333
Female termination plug	Z5309-2
Male termination plug	Z6332
12 in. 24 Ga. Type J T/C w/mini plug	Z5786
12 in. 24 Ga. Type K T/C w/mini plug	Z5639
Gender changer – M-F	Z6334
Gender changer – F-M	Z6335
6 in. power extension	Z6374
10 ft Type J T/C extension	Z6271

Note: All power connectors use AMP MATE-N-LOK™

Flexible Heaters

Line Heating

Modular Pump Line Heaters

The tight contact fit of Watlow's pump line heaters provide superior, uniform heating of transfer lines.

Agency Certification, Recognition Compliance and Approvals

- Complies with SEMI S2-93 standards
- UL® recognized for U.S. and Canadian safety standards
- CE, VDE
- National Electrical Code (NEC), Article #427-23
- UL® Listed available

Contact your Watlow representative for specific applications and approvals.

General Specifications

- The heater and jacket material are constructed using reinforced silicone rubber fabric.
- Insulation and outer jacket are gray. The heater is red-orange in color.

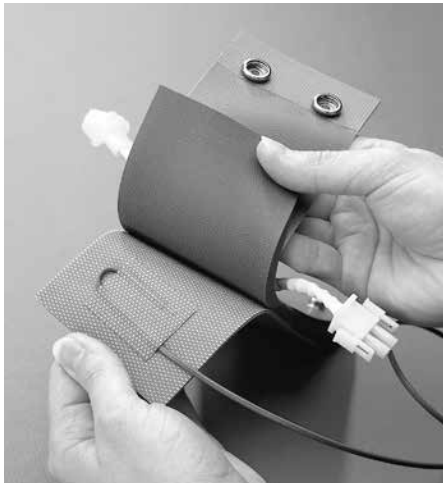

Sensor Pocket Built-in to all Straight Length Heaters 3 in. (76 mm) Long and Greater; One Per Heater

- Snap type fasteners are ½ in. (13 mm) with a nominal diameter metal construction and a nylon cover. The maximum operating temperature is 392°F (200°C).
- Hook and latch fasteners are available.
- 120 and 208VAC are standard. Contact your Watlow representative for other voltages.
- Power lead wires are 3 in. (76 mm) #18 AWG UL® 1180/CSA PTFE insulated and rated 10A. The lead wire pair is encapsulated in reinforced silicone rubber sleeving.
- Heaters are interconnectable up to a 10A circuit.
- Low watt density:
 - 1.5-2 in. (38-51 mm) diameter, 1.5 W/in² (0.23 W/cm²)
 - 3-4 in. (76-102 mm) diameter, 1.25 W/in² (0.19 W/cm²)

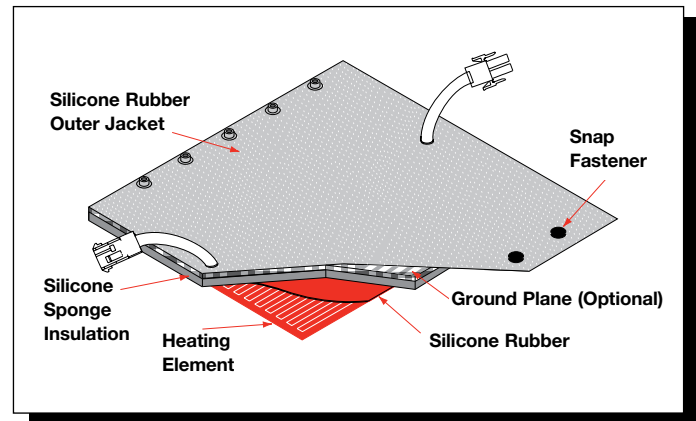
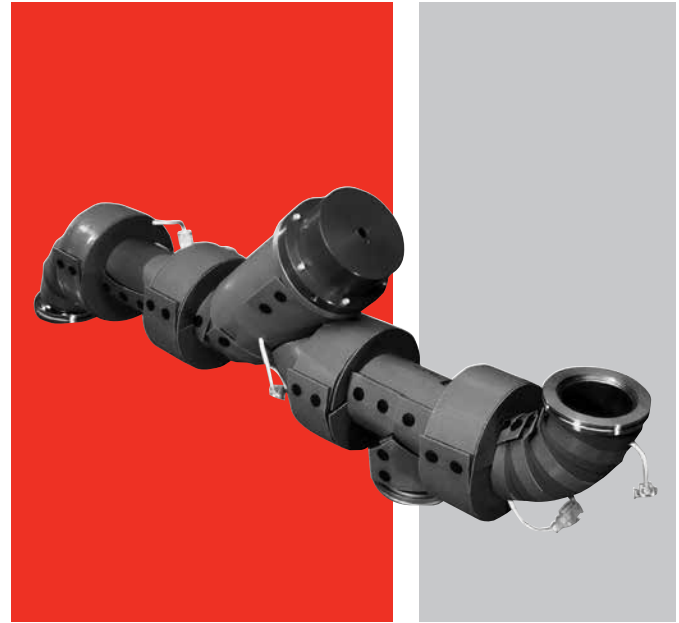

Flexible Heaters

Line Heating

Modular Pump Line Heaters (Continued)

Tube O.D.		Length "L"		Watts	Amperes @ 120V	Amperes @ 208V	Features	Base Part Number*
in.	(mm)	in.	(mm)					
1.5	(38)	2	(51)	15	0.13	0.08	—	020050A
1.5	(38)	2T	(51T)	8	0.07	N/A	Trim-to-fit	020050T
1.5	(38)	3	(76)	22	0.19	0.11	Sensor pocket	030050A
1.5	(38)	3T	(76T)	15	0.13	0.08	Trim-to-fit	030050T
1.5	(38)	4	(102)	29	0.25	0.14	Sensor pocket	040050A
1.5	(38)	4T	(102T)	22	0.19	0.11	Trim-to-fit	040050T
1.5	(38)	5	(127)	36	0.30	0.18	Sensor pocket	050050A
1.5	(38)	5T	(127T)	29	0.25	0.14	Trim-to-fit	050050T
1.5	(38)	6	(152)	43	0.36	0.21	Sensor pocket	050060A
1.5	(38)	6T	(152T)	36	0.30	0.17	Trim-to-fit	050060T
1.5	(38)	7	(178)	50	0.42	0.24	Sensor pocket	050070A
1.5	(38)	8	(203)	57	0.48	0.27	Sensor pocket	050080A
1.5	(38)	9	(229)	64	0.53	0.31	Sensor pocket	050090A
1.5	(38)	10	(254)	71	0.59	0.34	Sensor pocket	050100A
1.5	(38)	12	(305)	85	0.71	0.41	Sensor pocket	050120A
1.5	(38)	18	(457)	128	1.07	0.62	Sensor pocket	050180A
1.5	(38)	24	(610)	170	1.42	0.82	Sensor pocket	050240A
1.5	(38)	30	(762)	213	1.78	1.03	Sensor pocket	050300A
1.5	(38)	36	(914)	255	2.13	1.23	Sensor pocket	050360A
1.5	(38)	36	(914)	Insulator	N/A	N/A	—	050360B
2.0	(51)	2	(51)	19	0.16	0.10	—	020066A
2.0	(51)	2T	(51T)	10	0.09	N/A	Trim-to-fit	020066T
2.0	(51)	3	(76)	29	0.25	0.14	Sensor pocket	030066A
2.0	(51)	3T	(76T)	19	0.16	0.10	Trim-to-fit	030066T
2.0	(51)	4	(102)	38	0.32	0.19	Sensor pocket	040066A
2.0	(51)	4T	(102T)	29	0.25	0.14	Trim-to-fit	040066T
2.0	(51)	5	(127)	48	0.40	0.24	Sensor pocket	050066A
2.0	(51)	5T	(127T)	38	0.32	0.19	Trim-to-fit	050066T
2.0	(51)	6	(152)	57	0.48	0.28	Sensor pocket	060066A
2.0	(51)	6T	(152T)	47	0.39	0.23	Trim-to-fit	060066T
2.0	(51)	7	(178)	66	0.55	0.32	Sensor pocket	066070A
2.0	(51)	8	(203)	76	0.63	0.37	Sensor pocket	066080A
2.0	(51)	9	(229)	85	0.71	0.41	Sensor pocket	066090A

CONTINUED

• M - Manufacturing lead times

*To complete the part number, please reference the *Ordering Information* on page 147.

Flexible Heaters

Line Heating

Modular Pump Line Heaters (Continued)

Tube O.D.		Length "L"		Watts	Amperes @ 120V	Amperes @ 208V	Features	Base Part Number*
in.	(mm)	in.	(mm)					
2.0	(51)	10	(254)	95	0.79	0.46	Sensor pocket	066100A
2.0	(51)	12	(305)	114	0.95	0.55	Sensor pocket	066120A
2.0	(51)	18	(457)	170	1.42	0.82	Sensor pocket	066180A
2.0	(51)	24	(610)	227	1.90	1.10	Sensor pocket	066240A
2.0	(51)	30	(762)	283	2.36	1.37	Sensor pocket	066300A
2.0	(51)	36	(914)	340	2.84	1.64	Sensor pocket	066360A
2.0	(51)	36	(914)	Insulator	N/A	N/A	—	066360B
3	(76)	2	(51)	24	0.20	0.12	—	020096A
3	(76)	2T	(51T)	12	0.10	0.06	Trim-to-fit	020096T
3	(76)	3	(76)	36	0.30	0.18	Sensor pocket	030096A
3	(76)	3T	(76T)	24	0.20	0.12	Trim-to-fit	030096T
3	(76)	4	(102)	48	0.40	0.24	Sensor pocket	040096A
3	(76)	4T	(102T)	36	0.30	0.18	Trim-to-fit	040096T
3	(76)	5	(127)	59	0.50	0.29	Sensor pocket	050096A
3	(76)	5T	(127T)	48	0.40	0.24	Trim-to-fit	050096T
3	(76)	6	(152)	71	0.60	0.35	Sensor pocket	060096A
3	(76)	6T	(152T)	59	0.49	0.28	Trim-to-fit	060096T
3	(76)	7	(178)	83	0.69	0.4	Sensor pocket	070096A
3	(76)	8	(203)	95	0.79	0.46	Sensor pocket	080096A
3	(76)	9	(229)	106	0.88	0.51	Sensor pocket	090096A
3	(76)	10	(254)	118	0.98	0.57	Sensor pocket	096100A
3	(76)	12	(305)	142	1.19	0.69	Sensor pocket	096120A
3	(76)	18	(457)	213	1.78	1.03	Sensor pocket	096180A
3	(76)	24	(610)	283	2.36	1.37	Sensor pocket	096240A
3	(76)	30	(762)	354	2.95	1.71	Sensor pocket	096300A
3	(76)	36	(914)	425	3.55	2.05	Sensor pocket	096360A
3	(76)	36	(914)	Insulator	N/A	N/A	—	096360B

CONTINUED

• **M** - Manufacturing lead times

*To complete the part number, please reference the *Ordering Information* on page 147.

Flexible Heaters

Line Heating

Modular Pump Line Heaters (Continued)

Tube O.D.		Length "L"		Watts	Amperes @ 120V	Amperes @ 208V	Features	Base Part Number*
in.	(mm)	in.	(mm)					
4	(102)	2	(51)	32	0.27	0.16	—	020128A
4	(102)	2T	(51T)	16	0.14	0.08	Trim-to-fit	020128T
4	(102)	3	(76)	48	0.40	0.24	Sensor pocket	030128A
4	(102)	3T	(76T)	32	0.27	0.16	Trim-to-fit	030128T
4	(102)	4	(102)	63	0.53	0.31	Sensor pocket	040128A
4	(102)	4T	(102T)	48	0.40	0.24	Trim-to-fit	040128T
4	(102)	5	(127)	79	0.66	0.38	Sensor pocket	050128A
4	(102)	5T	(127T)	63	0.53	0.31	Trim-to-fit	050128T
4	(102)	6	(152)	95	0.80	0.46	Sensor pocket	060128A
4	(102)	6T	(152T)	79	0.66	0.38	Trim-to-fit	060128T
4	(102)	7	(178)	110	0.92	0.53	Sensor pocket	070128A
4	(102)	8	(203)	126	1.05	0.61	Sensor pocket	080128A
4	(102)	9	(229)	142	1.18	0.68	Sensor pocket	090128A
4	(102)	10	(254)	157	1.31	0.75	Sensor pocket	100128A
4	(102)	12	(305)	189	1.58	0.91	Sensor pocket	120128A
4	(102)	18	(457)	283	2.36	1.37	Sensor pocket	128180A
4	(102)	24	(610)	377	3.15	1.82	Sensor pocket	128240A
4	(102)	30	(762)	472	3.94	2.27	Sensor pocket	128300A
4	(102)	36	(914)	566	4.72	2.73	Sensor pocket	128360A
4	(102)	36	(914)	Insulator	N/A	N/A	—	128360B

• **M** - Manufacturing lead times

*To complete the part number, please reference the *Ordering Information* on page 147.

Flexible Heaters

Line Heating

Modular Pump Line Heaters (Continued)

90° Radius Elbow Heaters

- 0.25 in. (6 mm) or 0.5 in. (13 mm) silicone rubber sponge insulation is available
- With or without tangents
- Will fit both butt-weld and flanged style tubing elbows

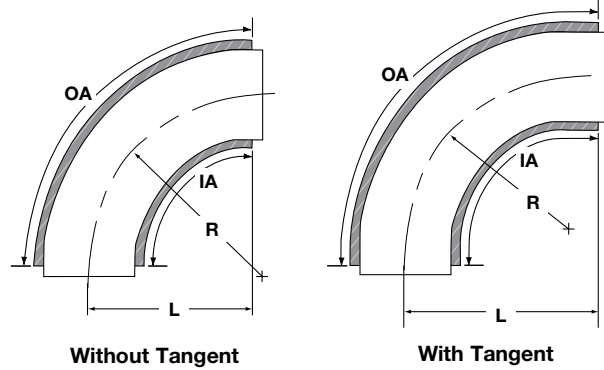

Tube O.D. in. (mm)	Length "L" in. (mm)	Radius (R) in. (mm)	Watts	Outer Arc Length (OA)	Inside Arc Length (IA)	Amperes @120V	Amperes @208V	Base Part Number*
1.5 (38)	2.00 (51.0)	2.25 (57)	26	4.21	1.85	0.22	0.13	042050A
1.5 (38)	2.68 (68.1)	2.25 (57)	36	5.58	3.22	0.30	0.18	050055A
2.0 (51)	2.75 (70.0)	3.00 (76)	45	5.78	2.64	0.38	0.22	057066A
2.0 (51)	3.81 (96.8)	3.00 (76)	65	7.91	4.77	0.55	0.32	066079A
3.0 (76)	4.00 (102.0)	4.50 (114)	84	8.42	3.71	0.70	0.41	089097A
3.0 (76)	5.81 (147.6)	4.50 (114)	127	12.05	7.33	1.06	0.62	097125A
4.0 (102)	5.50 (140.0)	6.00 (152)	149	11.56	5.28	1.25	0.72	116128A
4.0 (102)	7.81 (198.4)	6.00 (152)	222	16.18	9.00	1.85	1.07	128166A

45° Radius Elbow Heaters

- 0.25 in. (6.4 mm) or 0.5 in. (13 mm) silicone rubber sponge insulation is available
- With or without tangents
- Will fit both butt-weld and flanged style tubing elbows

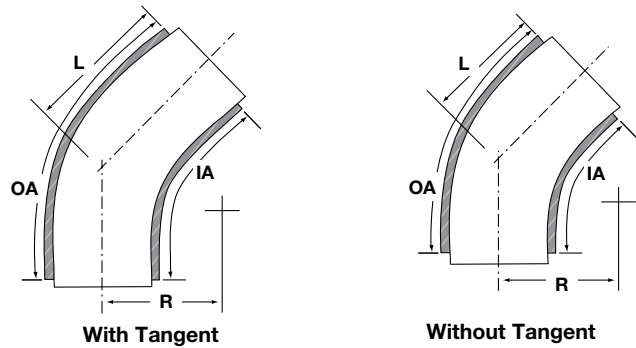

Tube O.D. in. (mm)	Length "L" in. (mm)	Radius (R) in. (mm)	Watts	Outer Arc Length (OA)	Inside Arc Length (IA)	Amperes @120V	Amperes @208V	Base Part Number*
1.5 (38)	0.69 (17.5)	2.25 (57)	14	1.85	0.67	0.12	NA	018050A
1.5 (38)	1.38 (35.1)	2.25 (57)	23	3.23	2.04	0.20	0.12	032050A
2.0 (51)	1.00 (25.0)	3.00 (76)	23	2.64	1.07	0.20	0.12	026066A
2.0 (51)	2.06 (52.3)	3.00 (76)	44	4.77	3.20	0.37	0.22	047066A
3.0 (76)	1.37 (34.8)	4.50 (114)	43	3.71	1.35	0.36	0.21	042097A
3.0 (76)	3.18 (80.8)	4.50 (114)	85	7.33	4.97	0.71	0.41	078097A
4.0 (102)	2.00 (51.0)	6.00 (152)	75	5.28	2.14	0.63	0.37	057128A
4.0 (102)	4.31 (109.5)	6.00 (152)	148	9.90	6.76	1.24	0.72	104128A

• M - Manufacturing lead times

*To complete the part number, please reference the *Ordering Information* on page 147.

Flexible Heaters

Line Heating

Modular Pump Line Heaters (Continued)

Tee Section Heaters

- 0.25 in. (6 mm) or 0.5 in. (13 mm) silicone rubber sponge insulation is available
- Will fit both butt-weld and flanged style tee sections

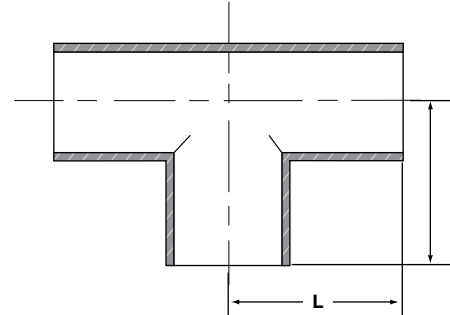

Tube O.D.		Length "L"		Watts	Amperes @120V	Amperes @208V	Base Part Number*
in.	(mm)	in.	(mm)				
1.5	(38)	2.00	(51)	38	0.32	0.19	047064A
2.0	(51)	2.75	(70)	69	0.58	0.34	062081A
3.0	(76)	3.00	(76)	89	0.75	0.43	095120A
4.0	(102)	3.63	(92)	140	1.17	0.69	125155A

Bellows Section Heaters

- 0.25 in. (6 mm) or 0.5 in. (13 mm) silicone rubber sponge insulation is available
- Will fit both butt-weld and flanged style flexible sections

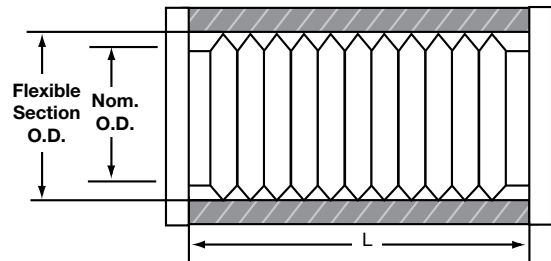

Tube O.D.		Bellows Section O.D.		Length "L"		Watts	Amperes @120V	Amperes @208V	Base Part Number*
in.	(mm)	in.	(mm)	in.	(mm)				
1.5	(38)	1.92	(48.9)	3	(76)	26	0.22	0.13	030056A
1.5	(38)	1.92	(48.9)	3T	(76T)	18	0.15	0.09	030056T
1.5	(38)	1.92	(48.9)	6	(152)	51	0.43	0.25	056060A
1.5	(38)	1.92	(48.9)	6T	(152T)	44	0.37	0.21	056060T
2.0	(51)	2.47	(62.7)	3	(76)	34	0.29	0.17	030077A
2.0	(51)	2.47	(62.7)	3T	(76T)	24	0.2	0.12	030077T
2.0	(51)	2.47	(62.7)	6	(152)	68	0.57	0.33	060077A
2.0	(51)	2.47	(62.7)	6T	(152T)	59	0.49	0.28	060077T
3.0	(76)	3.77	(95.8)	3	(76)	44	0.37	0.22	030117A
3.0	(76)	3.77	(95.8)	3T	(76T)	30	0.25	0.14	030117T
3.0	(76)	3.77	(95.8)	6	(152)	88	0.74	0.43	060117A
3.0	(76)	3.77	(95.8)	6T	(152T)	74	0.62	0.36	060117T
3.0	(76)	3.77	(95.8)	12	(305)	175	1.46	0.85	117120A
4.0	(102)	4.75	(121.0)	3	(76)	56	0.47	0.27	030149A
4.0	(102)	4.75	(121.0)	3T	(76T)	38	0.32	0.18	030149T
4.0	(102)	4.75	(121.0)	6	(152)	111	0.93	0.54	060149A
4.0	(102)	4.75	(121.0)	6T	(152T)	94	0.78	0.45	060149T
4.0	(102)	4.75	(121.0)	12	(305)	222	1.85	1.07	120149A

• **M** - Manufacturing lead times

*To complete the part number, please reference the *Ordering Information* on page 147.

Flexible Heaters

Line Heating

Modular Pump Line Heaters (Continued)

Reducers

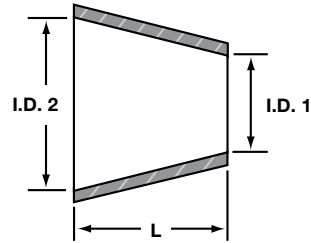

Tube I.D. 2 to I.D. 1 in. (mm)	Length "L" in. (mm)	Watts	Amperes @120V	Amperes @208V	Base Part Number*
2 (51) to 1.5 (38)	1.38 (35.1)	12	0.10	0.06	020062A
3 (76) to 2.0 (51)	2.42 (61.5)	24	0.20	0.12	034090A
4 (102) to 2.0 (51)	2.63 (66.8)	31	0.26	0.15	044103A
4 (102) to 3.0 (76)	2.60 (66.0)	36	0.30	0.18	040121A

Flange Heaters

- 0.25 in. (6 mm) or 0.5 in. (13 mm) silicone rubber sponge insulation is available
- For both KF screw flanges and ISO clamp flanges

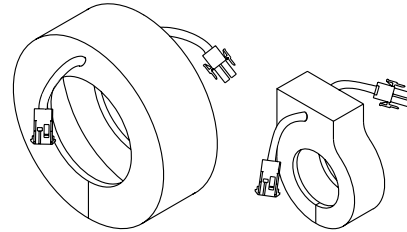

Tube O.D. in.	Nominal Tube O.D. in. (mm)	Watts @120V	Amperes @120V	Amperes @ 208V	Base Part Number*
KF-40	1.5 (38)	10	0.09	NA	035040A
KF-50	2.0 (51)	15	0.13	0.07	045050A
ISO-80	3.0 (76)	70	0.59	0.34	020176A
ISO-100	4.0 (102)	82	0.69	0.40	020204A
CF 2 ³ / ₄ in.	1.5 (38)	21	0.18	0.10	016089A

Flange Insulators

- 0.25 in. (6 mm) or 0.5 in. (13 mm) silicone rubber sponge insulation is available
- For both KF screw flanges and ISO clamp flanges

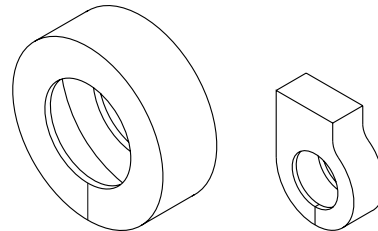

Tube O.D. in.	Nominal Tube O.D. in. (mm)	Base Part Number*
KF-40	1.50 (38)	035040B
KF-50	2.00 (51)	045050B
ISO-80	3.00 (76)	020176B
ISO-100	4.00 (102)	020204B
CF 1 ¹ / ₃ in.	0.75 (19)	010044B
CF 2 ³ / ₄ in.	1.50 (38)	016089B

- **M** - Manufacturing lead times

*To complete the part number, please reference the *Ordering Information* on page 147.

Flexible Heaters

Line Heating

Modular Pump Line Heaters (Continued)

Ordering Information

Part Number

① Base Code Nbr. X	② Base Code Nbr. X	③ Base Code Nbr. X	④ Base Code Nbr. X	⑤ Base Code Nbr. X	⑥ Base Code Nbr. X	⑦ Base Code Nbr. X	⑧ ⑨ Heater Voltage	⑩ Insulation	⑪ Connectors	⑫ Sensors	⑬ Future Option 0	⑭ Future Option 0
---------------------------------	---------------------------------	---------------------------------	---------------------------------	---------------------------------	---------------------------------	---------------------------------	-----------------------	-----------------	-----------------	--------------	--------------------------------	--------------------------------

① ② ③ ④ ⑤ ⑥ ⑦ Base Code Number

⑧ ⑨ Heater Voltage

CO =	Insulator
C1 =	120V
C4 =	208V

⑩ Insulation

A =	0.25 in. (6 mm) insulation w/UL® 94-HB jacket
B =	0.5 in. (13 mm) insulation w/UL® 94V-0 jacket
C =	0.25 in. (6 mm) insulation w/UL® 94-HB jacket and ground grid
D =	0.5 in. (13 mm) insulation w/UL® 94V-0 jacket and ground grid

⑪ Connectors

0 =	None (Zero)
A =	AMP Universal MATE-N-LOK™ connector
B =	AMP CPC connector

⑫ Sensors

0 =	None
A =	Thermal fuse 378°F (192°C)
B =	Type J thermocouple
C =	Type K thermocouple
D =	Thermal fuse + Type J thermocouple
E =	Thermal fuse + Type K thermocouple

⑬ Future Option

0 =	None (Zero)
-----	-------------

⑭ Future Option

0 =	None (Letter O)
-----	-----------------

Note: All options are not available for every base part number.

Description	CE	SEMI S2-93	UL® Listing	NEC	VDE
0.25 in. (6 mm) insulation w/HOT marking	x	x	x		x
0.5 in. (13 mm) insulation	o	o	o		o
Ground grid	o	o	o	x	o
AMP MATE-N-LOK™ connectors ①	x	x	x		x
AMP CPC connectors ②	o	o	o		o
Jacket w/UL® 94V-0 rating	o	o	o		o
Jacket w/UL® 94-HB rating	x	x	x		x
Thermal cut-off	o	x	x		o

x = Min. requirements

o = Optional features

① Male plug: AMP p/n 1-480698-0, w/sockets AMP p/n 350689-1.
Female cap: AMP p/n 1-480699-0, w/pins AMP p/n 350690-1.

② Plug: AMP p/n 206060-1, w/socket AMP p/n 66101-3.

Receptacle: AMP p/n 206153-1, w/pin AMP p/n 66099-3, w/ground pin p/n 164164-2 if ground grid option is chosen.

Flexible Heaters

Polyimide Heaters

Polyimide is a thin, lightweight organic polymer film that provides excellent tensile strength, tear and solvent resistance and dimensional stability. The polyimide heater is ideal for applications requiring low outgassing in a vacuum or resistance to radiation, fungus and chemicals.

Performance Capabilities

- For operating environments as low as -319°F (-195°C), heater temperature as high as 392°F (200°C)
- Watt densities up to 50 W/in² (7.75 W/cm²)^①
- UR[®] and C-UR[®] recognitions

Features and Benefits

Excellent physical and electrical properties

- Results in thermal stability over a wide temperature range

Transparent polyimide material

- Allows inspection of internal details

Resistance of radiation and fungus

- Can be used in a wide range of applications

Typical Applications

- Medical applications that require a clean, sterile environment
- Laboratory research
- Semiconductor processing equipment
- Optical equipment
- LCD displays
- Computer equipment
- Photographic equipment
- Aerospace/defense, where low outgassing properties are required

^① Watt density limits are application dependent (operating temperatures, bonding method and heat sink).

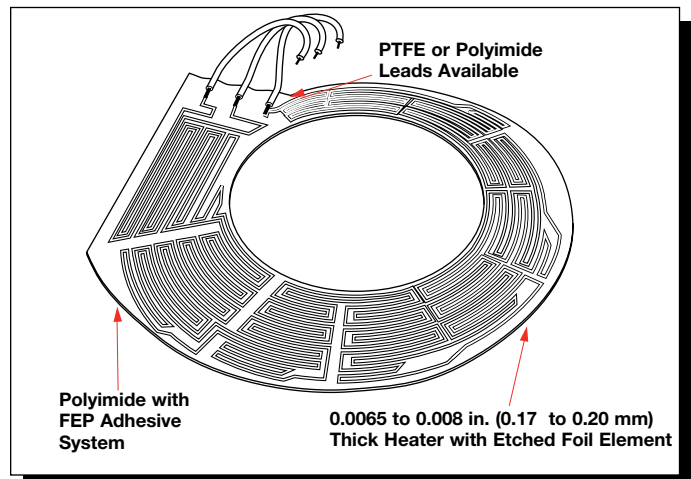
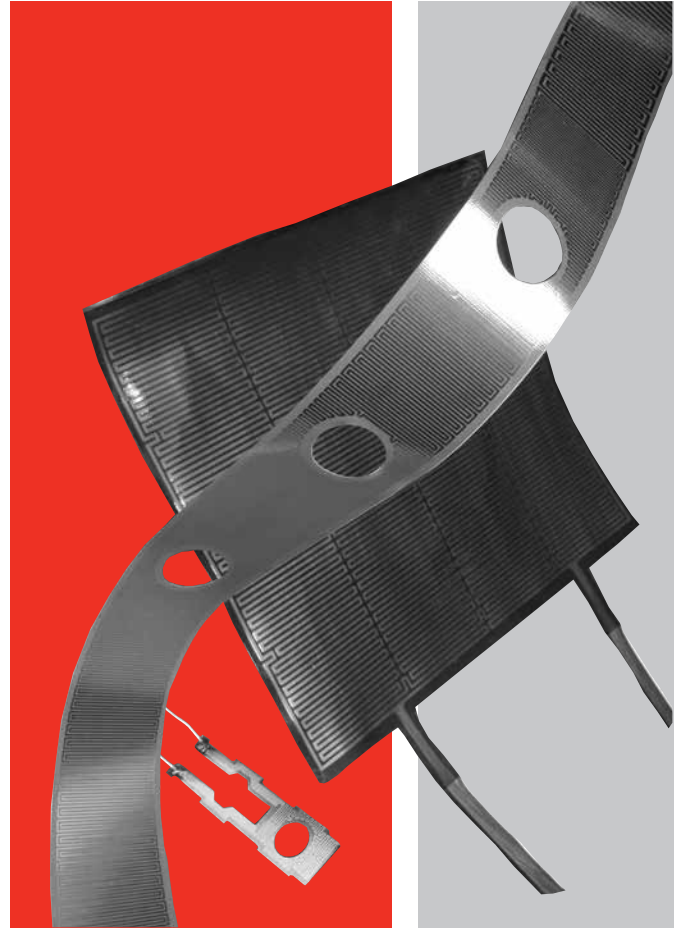

Flexible Heaters

Polyimide Heaters

Technical Data

Specifications

Thickness

- 0.007 in. (0.2 mm)

Flexibility (min. radius)

- $\frac{1}{32}$ in. (0.8 mm)

Weight

- 1.5 oz/ft² (0.05 g/cm²)

Operating temperature:

- Max.: 392°F (200°C)
- Min.: -319°F (-195°C)

Watt density rating on stock units

- 5 W/in² (0.8 W/cm²)

Dielectric strength

- Min. VAC: 1000

Flammability rating

- Self-extinguishing

Heater size limitations

- 18 x 26 in. (457 mm x 660 mm)

Weight loss (outgassing):

- 0.51%

Lead length

- 12 in. (305 mm) PTFE E

Maximum Allowable Watt Density Versus Temperature

To achieve optimum performance with your Watlow polyimide heater, use a proper watt density on the surface of the heater.

The graph recommends watt densities for temperatures using a temperature controller. It does not indicate the watt density needed to achieve a given part temperature.

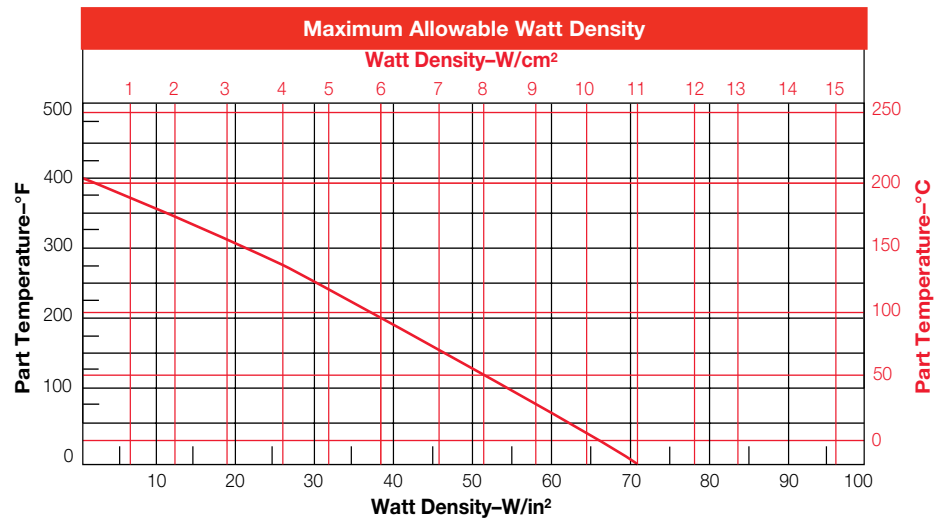

Note: The maximum watt density (W/in²) in open air is 5 W/in². The chart above assumes bonding the polyimide heater to a part.

Flexible Heaters

Polyimide Heaters

Rapid Ship Offering

Lead length, 12 in. (305 mm) "E" PTFE

Width		Length		Watts	28V Part Number	120V Part Number
in.	(mm)	in.	(mm)			
0.5	(13)	2	(51)	5	K005020C5-0009B	
1	(25)	1	(25)	5	K010010C5-0009B	
		3	(76)	15	K010030C5-0009B	
		5	(127)	25		K010050C3-0009B
		15	(381)	75		K010150C3-0009B
2	(51)	10	(254)	100		K020100C3-0009B
3	(76)	5	(127)	75		K030050C3-0009B
4	(102)	4	(102)	80		K040040C3-0009B
5	(127)	5	(127)	125		K050050C3-0009B

RAPID SHIP

- **RS** - Next day shipment up to 75 pieces depending on part number.

Option

- Pressure sensitive adhesive surface (PSAS). The heaters above can be ordered with the optional PSAS surface by adding an "A" suffix to the part number and replacing the first "0."
Example K010050C3-A009B

Flexible Heaters

Polyimide Heaters

Special Product Offering

Part Number	Size		Circuit	Resistance	Max. Voltage	Watts @ Max. Voltage
	in.	(mm)				
K05711980-A	1/2 x 2 1/8	(13 x 54)	A	40	12	4
K05711980-B	1 x 2 1/8	(25 x 54)	B	90	48	26
K05711980-C	1 1/2 x 2 1/8	(38 x 54)	C	145	75	39
K05711980-D	2 x 2 1/8	(51 x 54)	D	205	105	54
K05711980-E	1/2 x 3 5/8	(13 x 34.9)	E	80	48	29
K05711980-F	1 x 3 5/8	(25 x 92.1)	F	165	90	49
K05711980-G	1 1/2 x 3 5/8	(38 x 92.1)	G	275	120	52
K05711980-H	2 x 3 5/8	(51 x 92.1)	H	375	120	38
K05711980-I	1/2 x 5 3/4	(13 x 146)	I	130	60	28
K05711980-J	1 x 5 3/4	(25 x 146)	J	255	120	56
K05711980-K	1 x 1 1/8	(25 x 28.6)	K	28	12	5
K05711980-L	1/2 x 1 1/8	(13 x 28.6)	L	13	6	3
K05711980-M	1 in O.D.	(25)	M	32	12	5
K05711980-N	2 in O.D.	(51)	N	180	105	61
K05711980-O	4 in O.D.	(102)	O	185	120	78
K05711980-P	1 x 1 3/8	(25 x 34.9)	P	45	24	13

Note: Above heaters are shipped without power leads unless specified, see below.

Options

- **Pressure sensitive adhesive (PSAS) surface**
- **Polyimide Handy Heater Kit—For Quick Heating Solutions**
 - Watlow offers a convenient polyimide heater kit which consists of 16 polyimide heaters — 13 rectangular and three circular—in different sizes and resistances. When a small flexible heater is needed quickly, the correct heater that fits the application can be used.

Notes:

- **Example:** To order the J heater circuit with PSAS, use K05711980A-J.
To order the J heater circuit with PSAS and leads, use K05711980AL-J.
- Leads are shipped loose, not soldered. Leads are 12 in. (305 mm) “E” PTFE.

Other Features

- The heater sheet can be ordered with or without PSAS, depending on requirements. To specify PSAS add **A** to the part number.
- The kit includes instructions for wiring, lead attachment, selection and installation. Pre-tinned solder pads are provided for easy lead connections.
- Instructions show how to dial in the desired wattage using a variable voltage transformer.
- Heaters can be wired individually, in series or in parallel, for hundreds of variations to satisfy special applications.

Flexible Heaters

SERIES EHG®

Many applications requiring a fixed temperature set point rely on a mechanical thermostat for thermal control. Thermostats have proven, however, to be inadequate for many applications due to long-term reliability issues, such as 100,000 cycle rating and poor temperature control.

The SERIES EHG® thermal solution includes a compact temperature controller, thermocouple sensor and power switching device integrated into the heater's power cord. The SERIES EHG reduces system costs and lasts substantially longer than a conventional thermostat solution.

The evolution of miniature microprocessor technology and Watlow switching technology fostered development of a small, versatile temperature controller and thermocouple sensor that is integrated with Watlow silicone rubber heater products. This device senses the temperature via input from a thermocouple strategically placed on the heater mat. The microprocessor is programmed prior to shipment with an application specific set point. This results in quick delivery of a custom, integrated system.

The small thermocouple mass provides superior response to changes in process temperature enabling higher watt density silicone rubber heater designs. These features offer an integrated custom set point temperature controller with superior life span, faster heat-up rates and improved accuracy. The SERIES EHG system has been tested to over four million cycles at rated amperage. Depending on the application, Watlow's power switching design can last up to 40 times longer than a conventional thermostat.

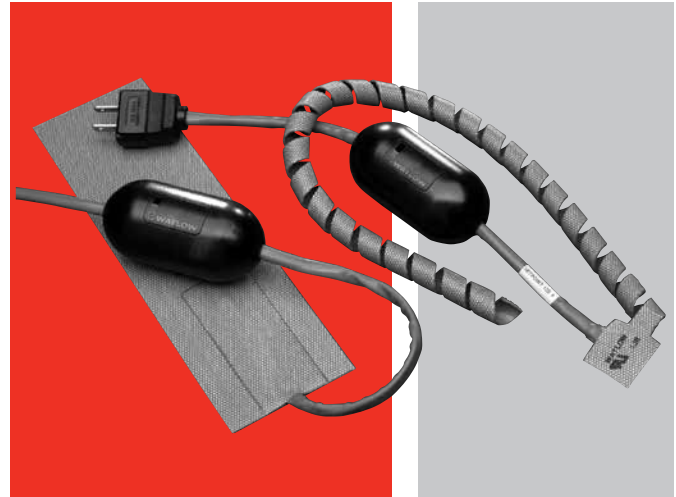

Features and Benefits

Long operational life

- Improves system reliability

Tight temperature control

- Ensures process accuracy

Small sensor footprint

- Fits with almost any heater
- Responds quickly to temperature changes
- Controls high watt densities in low mass applications

A single EHG controller can be configured with multiple heaters

- Reduces system cost

Pre-wired, in line control

- Simplifies installation
- Offers two-wire power connection

Durable housing with built-in strain relief

- Protects electronics
- Provides low risk of mechanical damage

Manufactured with proven Watlow components

- Assures reliable system performance

Typical Applications

- Semiconductor processing
- Aerospace composite repair
- Foodservice equipment
- Freeze protection
- Life sciences
- Telecommunications

Flexible Heaters

SERIES EHG

Technical Information

Specifications

Operational

- SERIES EHG silicone rubber heater UL[®] recognized to 428°F (220°C) operating temperature
- Factory programmed fixed set point
- On-off control with 6°F (3°C) switching hysteresis
- Temperature band LED indicator ON between -68 and +68°F (-20 and +20°C) of set point

Electrical

- Voltage rating: 120 or 240VAC – 30/+10%, 50/60Hz
- Silicone rubber heater watt densities up to 80 W/in² (12.5 W/cm²) dependent on application temperature
- SERIES EHG system UL[®] recognized to 10A max.

Sensor

- Type K thermocouple

Mechanical

- Control dimensions 3.75 in. (95 mm) long by 1.75 in. (45 mm) diameter
- Heater per silicone rubber heater specifications

Agencies

- Silicone rubber heater: UL[®] recognized File #E52951
- SERIES EHG control: TUV File DE 3-3068 to EN 61010-1:2001, UL[®] File E43684 to UL[®] 873 temperature indicating and regulating equipment

Environmental

- Control operating temperature range 32 to 158°F (0 to 70°C)
- Control storage temperature range -40 to 158°F (-40 to 70°C)

Contact your Watlow representative for custom configurations.

SERIES EHG Versus Thermostat (typical application)

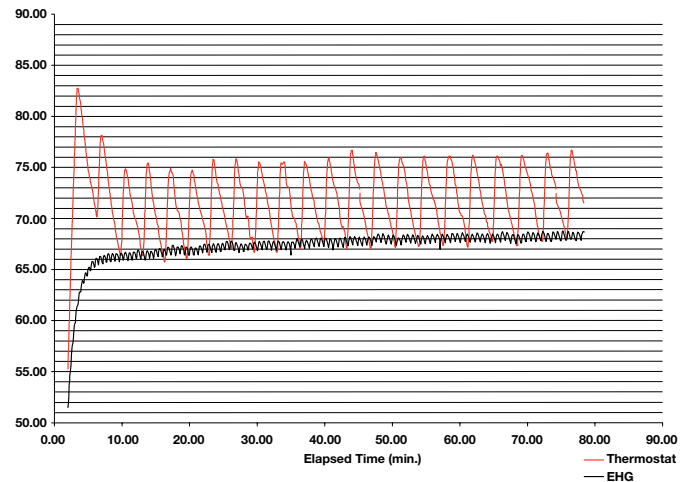

Dimensions

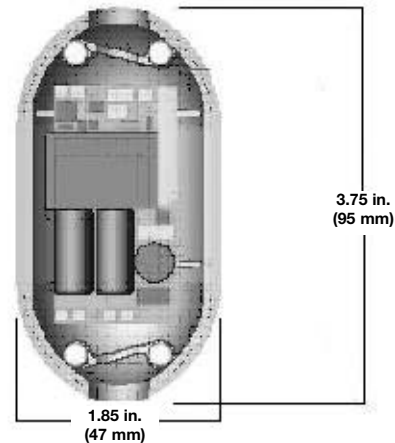

Integrated SERIES EHG System Versus Integrated Thermostat System

	Integrated EHG System	Integrated Thermostat System	SERIES EHG Benefit
Life comparison at rated amperage	Tested to greater than 4,000,000 cycles with 10A load	Rated 100,000 cycles	Longer product life of SERIES EHG system and high application reliability
Switch hysteresis	6°F (3°C)	15°F (8°C)	Provides superior process control
Improved response time reduces overshoot on start-up	6°F (3°C) typical	25°F (14°C) typical	Responds to temperature changes faster than a thermostat
Warranty	2 years for material and workmanship	1 year on material and workmanship	Warranty can be extended due to longer life cycle
Zero cross switching	SERIES EHG has zero cross switching	Random switching during sign wave cycle	Reduces the possibility of electrical mechanical interference (EMI)

Flexible Heaters

SERIES EHG SL10

The SERIES EHG SL10 integrated, multi-function controller is a key component to a powerful system that integrates a heater, an adjustable set point temperature controller, a high/low temperature alert, a power switching device and a high temperature safety limit. Its agency recognized controller/safety limit meets UL® 1998 and CE 60730 requirements.

An optional display/communications module can be easily added in the field to provide a digital display indication, an adjustment of set point, RS485 Modbus® communications and other Human Machine Interface (HMI) features. As a scalable system, only what is needed can be purchased.

The EHG SL10 controllers' easy to install, compact design, inherent reliability and integrated limit functions offer unmatched value. It is designed for easy integration with Watlow heaters to simplify engineering, reduce component count for new equipment and decrease ownership cost. For original equipment manufacturers, (OEMs), CE, Semi-S2 compliance and UL® recognition, the EHG controller reduces time and costs associated with global agency testing and validation.

Features and Benefits

Process controller and safety limit in one package

- Meets UL® 1998 and CE 60730 requirements
- Eliminates the need for a thermal fuse on a heater
- Eliminates replacement of heater when fuse fails

Optional display/communications module

- Allows easy upgrade on to base device
- Offers low cost field upgrade
- Provides easy, snap-on installation

Accurate and flexible temperature process controller

- Replaces problematic bi-metal thermostats with accurate electronic temperature process controller
- Allows easy change of process parameters

Ambient operating temperature range 32 to 158°F (0 to 70°C)

- Increases reliability when mounting in harsh temperature environments or in close proximity to heaters

Integrated high/low temperature alert signal relay

- Provides dry contact output to activate external alarm or process function
- Signals control status with three integrated LEDs
- Allows a signal of up to two amperes 30VAC/VDC, Form A to alert if process temperature is out of range limits



Health check diagnostics

- Monitors maximum heater process temperature, maximum ambient temperature and thermocouple operation
- Provides health check signal to inform operator that the process is working correctly

Universal power supply

- Allows an input of 85 to 264VAC, 50/60Hz
- Provides safe control of up to 2400 watts with 10 amperes switching in both controller and safety limit

Can be switched from on-off and PID algorithm

- Increases product life (on-off control is default)
- Offers selectable PID control algorithm for tighter temperature uniformity

Universal 1/8 turn mounting bracket

- Allows mounting to most surfaces
- Provides flexible mounting—either horizontally or vertically

Typical Applications

Foodservice equipment

- Warming and serving equipment
- Food holding cabinets

Life sciences

- Laboratory equipment
- Medical equipment

Packaging

- Heat sealing bars
- Hot glue application equipment

Semiconductor processing

- Gas delivery lines

Flexible Heaters

SERIES EHG SL10

Technical Information

Specifications

Operational

- Two, Type K thermocouple inputs - process temperature control and safety limit
- Process temperature output - 10A NO-ARC relay
- Safety limit alarm - 10A relay
- High/low temperature alert - 2A 30VAC/VDC, Form A (single pole, normally open contact)
- On-off temperature controller algorithm, upgraded via communications to PID algorithm (min. cycle time 30 seconds)

Standard Molex® connectors

- Controllers are integral to the heater and are supplied by Watlow

Power

- Isolated universal power supply 85 to 264VAC, 50/60Hz
- Up to 2400 W with 10A switching capability

NO-ARC Relay

- 10A switching
- 4.5 million cycles

Environmental

- Ambient operating temperature range 32 to 158°F (0 to 70°C)

Agency Approvals

- UL® 1998/ C-UL®
- CE 60730
- Semi-S2

SERIES EHG Versus Thermostat (typical application)

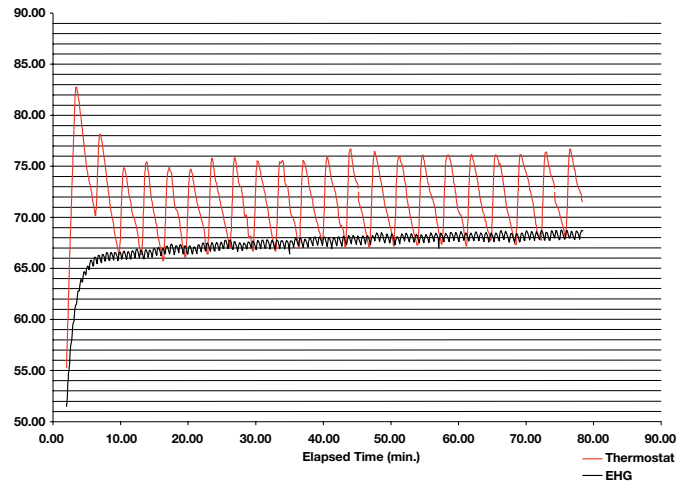

Dimensions

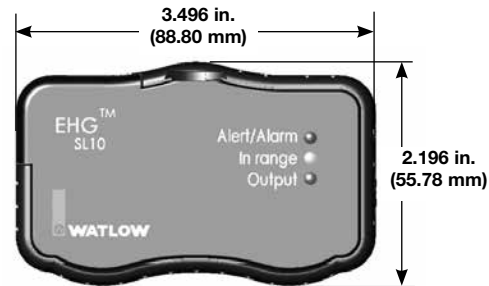

Base Unit



Without Optional Module



With Optional Module

Switching Device Comparison Chart

	T-Stat	Solid State Relay	Watlow NO-ARC Relay
Amperage at 77°F (25°C)	10A	10A	10A
Amperage at 158°F (70°C)	10A	De-rate significantly and add heat sink and air cooling	10A
Output device life at 10A	Rated 100,000 at 158°F (70°C)	Greater than 10 million cycles at 77°F (25°C)	Greater than 4.5 million cycles at 158°F (70°C)

Flexible Heaters

SERIES EHG SL10

Technical Information (Continued)

EHG SL10 Software

With the addition of an optional communication module, the EHG SL10 can be managed, monitored and manipulated via software. Change set points, label devices, change tuning parameters, check health status and much more all with the click of a key.



Reduces System Complexity and Cost

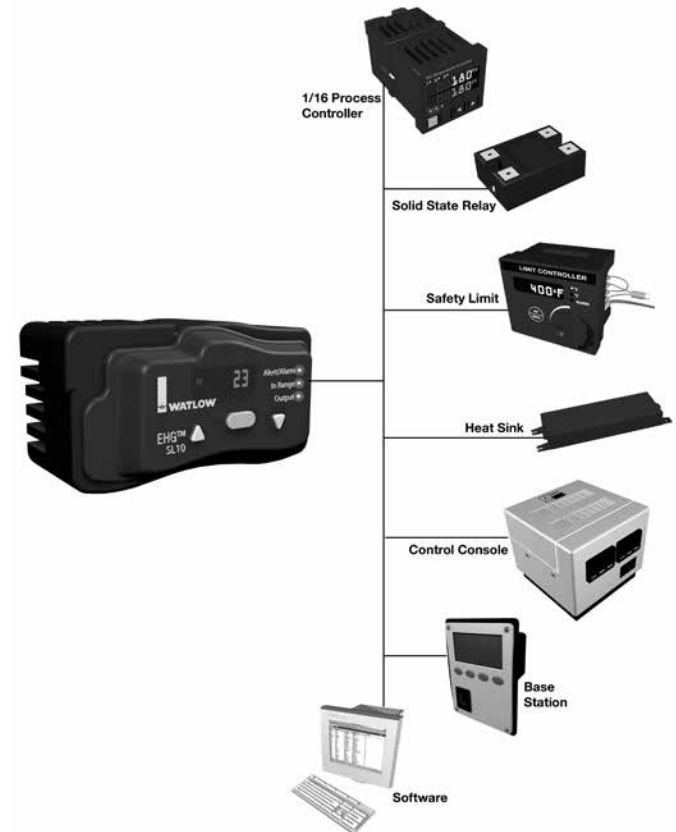

Mounting Bracket

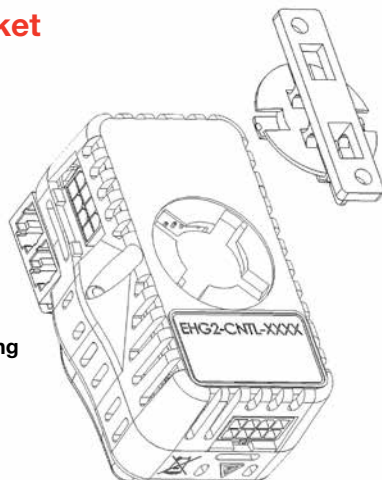

The EHG SL10 mounting enables the controller to be mounted in four angles.



The EHG SL10 can be "daisy-chained" for gas line and other assemblies.





Flexible Heaters

SERIES EHG SL10

Technical Information (Continued)

Optional Upgrade Modules

These upgrade modules are easy to install. There is no need to reconfigure, rewire or reorder the base unit. A technician is not needed for the installation, resulting in a seamless, cost-efficient system that can be upgraded.

		Diagnostics Memory Control Parameters	Ability to Change Temperature Parameters	Field Adjustable Set Point	3-Digit 7-Segment LED Display Illuminated	Diagnostic LED's	User Interface Software	Modbus® RTU Communication	RS 485
Base Unit		✓	✓			✓			
Optional Display Module		✓	✓	✓	✓	✓			
Optional Communication Module		✓	✓	✓		✓	✓	✓	✓
Optional Display and Communication Module		✓	✓	✓	✓	✓	✓	✓	✓

Ordering Information

Part Number

1 2 3 4 5 6	7 8 9
265 EG2	Modules

7	8	9	Modules
001	=		Base unit
007	=		Display module
008	=		Communications module
002	=		Display and communications module

Additional cables for wiring parallel heater circuits (daisy-chaining) in gas line and other assemblies

- 4800-0012 - Long cable
- 4800-0022 - Long terminating cable
- 4800-0011 - Short cable
- 4800-0021 - Short terminating cable

Compatible Accessories

Operator Interface Terminals (OIT)



Silver Series touchscreen operator interface terminals provide a customizable user interface and log and graph data for Watlow controllers and other devices. A Silver Series operator interface terminal paired with Watlow controllers, is the perfect solution for industrial processes or machine control applications.

Flexible Heaters

SERIES EHG CL

The SERIES EHG CL integrated, multi-function controller is a key component to a powerful system that includes a heater, an adjustable set point temperature controller, a high/low temperature alert, a power switching device and a high temperature safety limit. Its agency recognized controller/safety limit meets UL® 1998 and CE 60730 requirements.

An optional display/communications module can be easily added in the field to provide a digital display indication, an adjustment of set point, RS485 Modbus® communications and other Human Machine Interface (HMI) features. As a scalable system, only what is needed can be purchased.

The EHG CL controllers' easy to install, compact design, inherent reliability and integrated limit functions offer unmatched value. It is designed for easy integration with Watlow heaters to simplify engineering, reduce component count for new equipment and decrease ownership cost.

For original equipment manufacturers (OEMs), the EHG CL controller's CE, Semi-S2 compliance and UL® recognition reduces time and costs associated with global agency testing and validation. U.S. Patent Number 8,044,329

Features and Benefits

Temperature range -0.4 to 999°F (-18 to 537°C)

- Ideal for high temperature applications

Process controller and safety limit in one package

- Meets UL® 1998 and CE 60730 requirements
- Eliminates the need for a thermal fuse on a heater
- Eliminates replacement of heater when fuse fails

Optional display/communications module

- Allows easy upgrade on to base device
- Offers low cost field upgrade
- Provides easy, snap-on installation

Accurate and flexible temperature process controller

- Replaces problematic bi-metal thermostats with accurate electronic temperature process controller
- Allows easy change of process parameters

Ambient operating temperature range 32 to 158°F (0 to 70°C)

- Increases reliability when mounting in harsh temperature environments or in close proximity to heaters



Health check diagnostics

- Monitors maximum heater process temperature, maximum ambient temperature and thermocouple operation
- Provides health check signal to inform operator that the process is working correctly

Universal power supply

- Allows an input of 85 to 264VAC, 50/60Hz
- Provides safe control of up to 2400 watts with 10 amperes switching in both controller and safety limit

Can be switched from on-off and PID algorithm

- Increases product life (on-off control is default)
- Offers selectable PID control algorithm for tighter temperature uniformity

Universal 1/8 turn mounting bracket

- Allows mounting to most surfaces
- Provides flexible mounting—either horizontally or vertically

Typical Applications

Semiconductor processing

- Gas delivery lines
- Exhaust/pump lines

Life sciences

- Laboratory equipment
- Medical equipment
- Pharmaceutical

Flexible Heaters

SERIES EHG CL

Technical Information

Specifications

Operational

- Two, Type K thermocouple inputs - process temperature control and safety limit
- Process temperature output - 10A NO-ARC relay
- Safety limit alarm - 10A relay
- On-off temperature controller algorithm, upgraded via communications or display module to PID algorithm (min. cycle time 30 seconds)

Standard Molex® connectors

- Controllers are integral to the heater and are supplied by Watlow

Power

- Isolated universal power supply 85 to 264VAC, 50/60Hz
- Up to 2400 W with 10A switching capability

NO-ARC Relay

- 10A switching
- 4.5 million cycles

Environmental

- Ambient operating temperature range 32 to 158°F (0 to 70°C)

Agency Approvals

- UL® 1998/ C-UL®
- CE 60730
- Semi-S2

SERIES EHG CL Versus Thermostat (typical application)

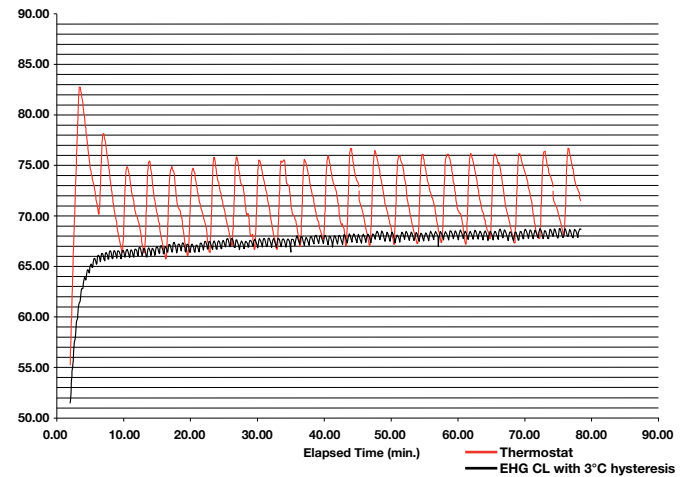

Dimensions

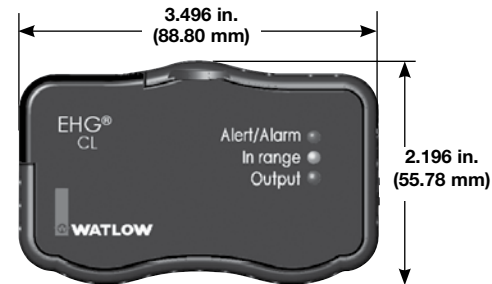

Base Unit



Without Optional Module

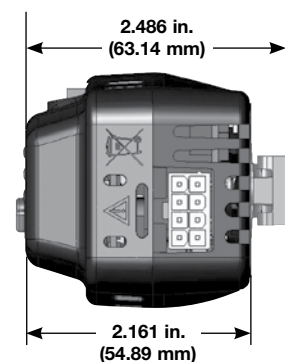

With Optional Module

Switching Device Comparison Chart

	T-Stat	Solid State Relay	Watlow NO-ARC Relay
Amperage at 77°F (25°C)	10A	10A	10A
Amperage at 158°F (70°C)	10A	De-rate significantly and add heat sink and air cooling	10A
Output device life at 10A	Rated 100,000 at 158°F (70°C)	Greater than 10 million cycles at 77°F (25°C)	Greater than 4.5 million cycles at 158°F (70°C)

Flexible Heaters

SERIES EHG CL

Technical Information (Continued)



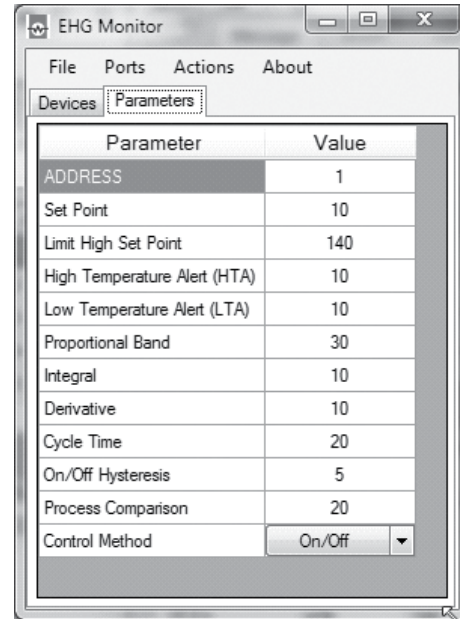
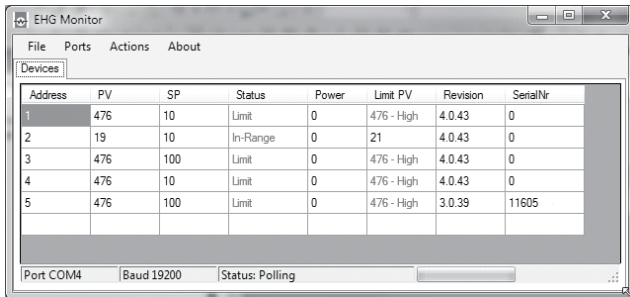

EHG CL Software

With the addition of an optional communication module, the EHG CL can be managed, monitored and manipulated via software. Change set points, label devices, change tuning parameters, check health status and much more all with the click of a key.



Optional Upgrade Modules

These upgrade modules are easy to install. There is no need to reconfigure, rewire or reorder the base unit. A technician is not needed for the installation, resulting in a seamless, cost-efficient system that can be upgraded.

		Diagnostics Memory Control Parameters	Ability to Change Temperature Parameters	Field Adjustable Set Point	3-Digit 7-Segment LED Display Illuminated	Diagnostic LED's	User Interface Software	Modbus® RTU Communication	RS 485
Base Unit		✓	✓			✓			
Optional Display Module		✓	✓	✓	✓	✓			
Optional Communication Module		✓	✓	✓		✓	✓	✓	✓
Optional Display and Communication Module		✓	✓	✓	✓	✓	✓	✓	✓

Flexible Heaters

SERIES EHG CL

Technical Information (Continued)



Modules can be upgraded and are easily replaceable.

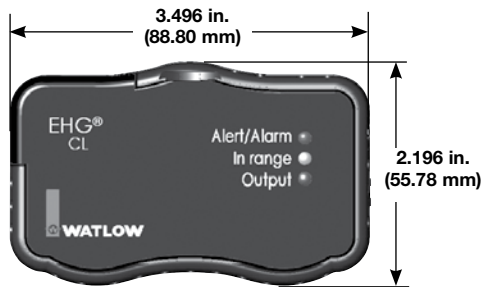

Base Unit

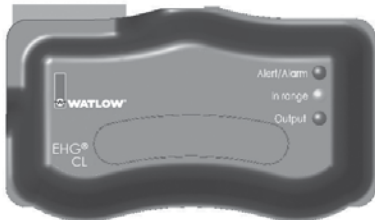

Communications Only Module



Display Only Module



Display and Communications Module

Ordering Information

Part Number

1 2 3 4 5 6	7 8 9
265 EG3	Base/ Module

7	8	9	Base/Module
001	=		Base unit (extended temperature range)
002	=		Display module (extended temperature range)
003	=		Communications module (extended temperature range)
004	=		Display with communications module (extended temperature range)

Additional cables for wiring parallel heater circuits (daisy-chaining) in gas line and other assemblies

- 4800-0012 - Long cable
- 4800-0022 - Long terminating cable
- 4800-0011 - Short cable
- 4800-0021 - Short terminating cable

Availability

The EHG CL is available for shipment; please contact your Watlow representative for more information.

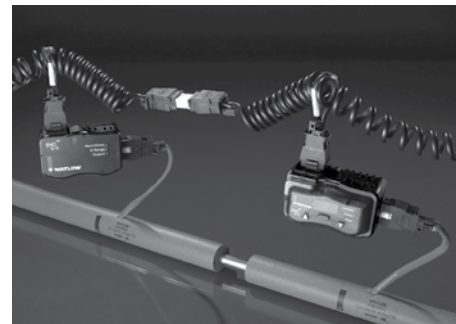

The EHG CL can be "daisy-chained" for gas line and other assemblies.

Mounting Bracket

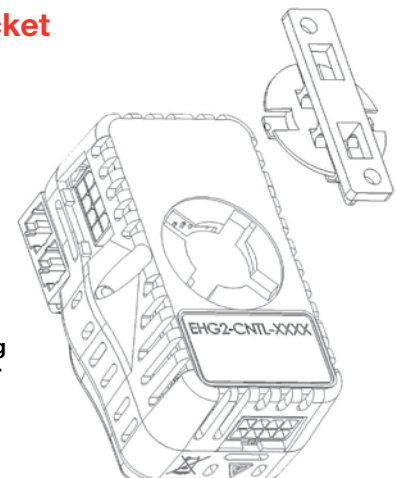

The EHG CL mounting enables the controller to be mounted in four angles.

