

gesis[®] ELECTRONIC
Dezentralized building
installation via plug & play

Catalog 2015

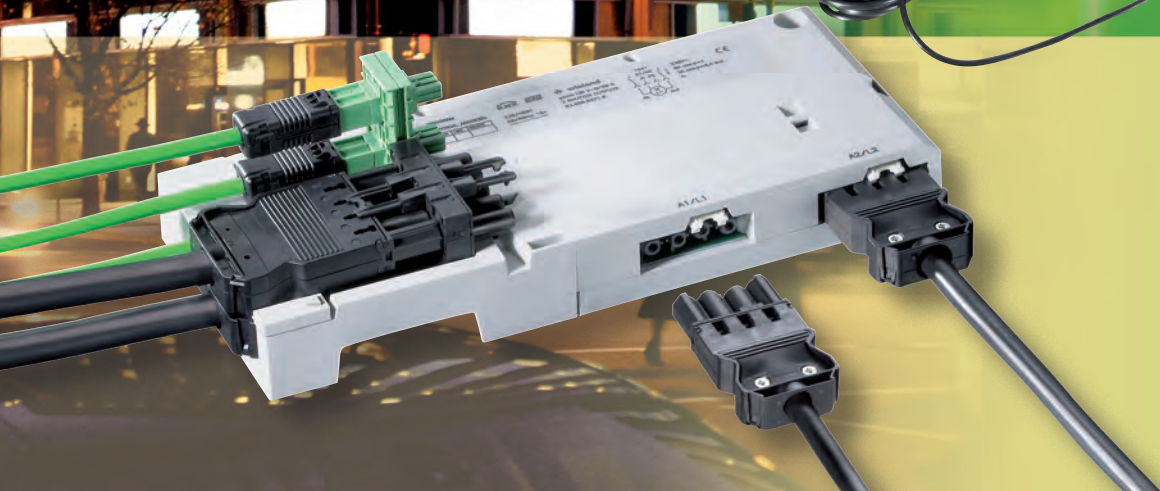

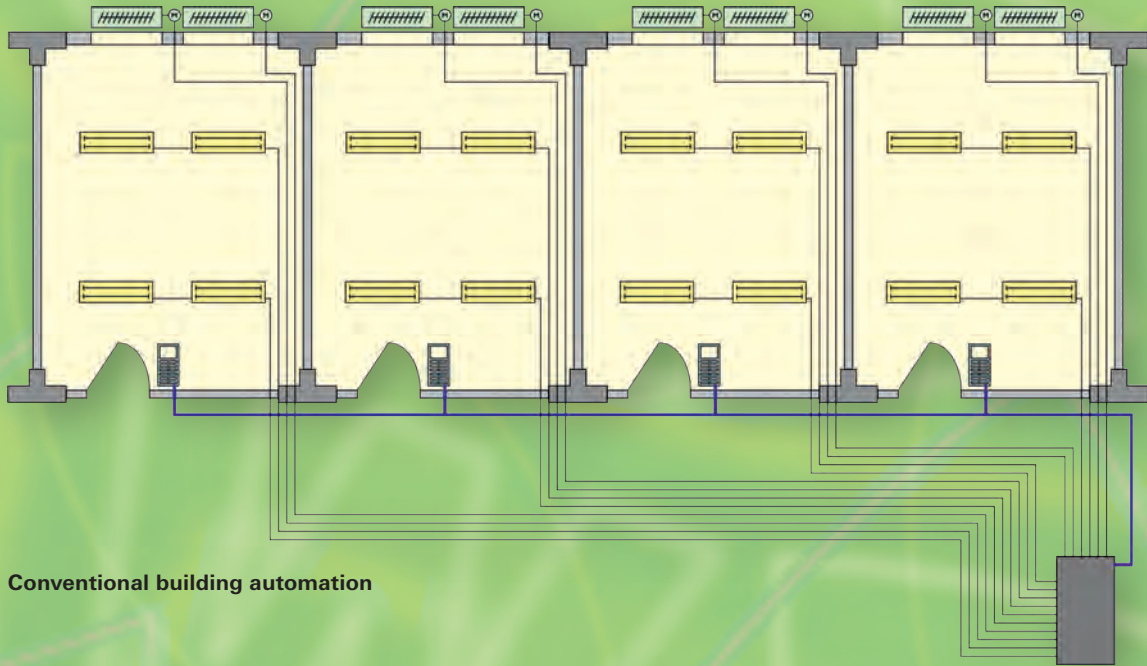



Conventional building automation

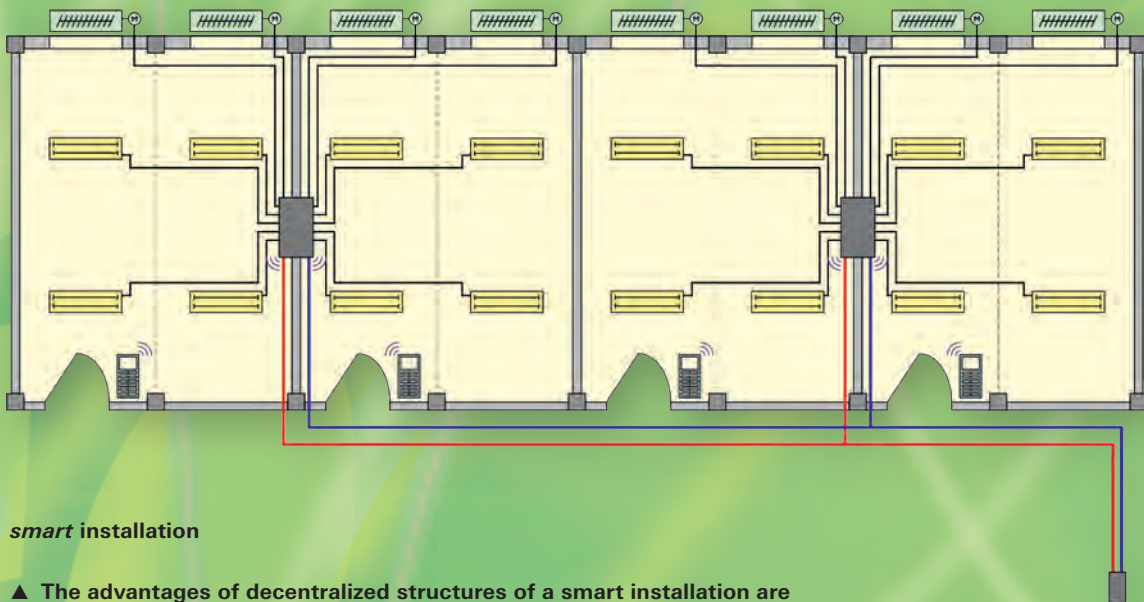

smart installation

▲ The advantages of decentralized structures of a smart installation are evident and further increase the space efficiency of a building.



gesis® FLEX
the flat, modular KNX system
for room automation



gesis® EIB V
flat, pluggable KNX actuators
for limited space

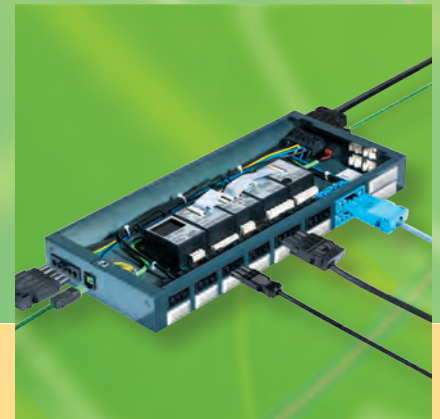

gesis® RM
the modular, project-specific
system for KNX, LON, and radio



gesis[®] ELECTRONIC – pluggable energy efficiency

Advantages of distributed building automation

Modern automation systems reduce the primary energy consumption of a building. *smart* installation concepts additionally implement the basic idea of a bus-based system by placing the components close to the consumers.

In combination with pluggability this leads to a flexible system whose functionality can be adapted quickly and easily to a change of use throughout the lifecycle of a building.

Consistent implementation can also improve the space efficiency of a building due to smaller utility rooms.

Advantages of distribution:

- smaller sub-distribution/utility rooms
- considerably reduced wiring expenses
- reduced demand for copper
- safety (in part fully functional during a bus failure)
- adaptable to change of use
- structured cabling

Advantages of pluggability:

- less prone to errors
- safe installation
- industrially pre-assembled quality
- flexible
- reusable
- faster installation
- structured cabling

Conclusion:

Reduced energy consumption and costs in construction phase and lifecycle of a building.



gesis[®] EIB M2
the modular, pluggable KNX system
for maximum flexibility on-site



gesis[®] RC
radio technology without batteries
for wireless sensors



Installation column
Room installation and automation
in one system

gesis[®] PLAN – 3D for presentation Displaying the design.

The **gesis**[®] PLAN demonstration and planning software is a tool for conveniently designing and calculating pluggable electrical installations with **gesis**[®]. The software supports specialist planners as well as system integrators, architects and clients in the electrical design of buildings.

The software imports the existing DWG/DXF drawings of the rooms and building parts to be installed. The required consumers, such as lamps, sockets and sunblinds, etc., are placed in the 3D view on the PC, and **gesis**[®] ELECTRONIC components, **gesis**[®] RAN distributor units and **gesis**[®] NRG flat cables are wired with only a few mouse clicks. The recommended connector encoding is automatically taken into account and the compliance with standards is checked. The installation is also calculated in terms of permitted currents, voltage drops or selectivity. Possible problems are immediately indicated by the software. As a result, the planner receives an item list with precisely calculated cable lengths and price details.

The **gesis**[®] PLAN software serves as an efficient planning aid for functional buildings with flexible use of space and facility management, and its usage is not only appropriate for new buildings. For building renovation it supports reliable preliminary planning through exact calculations. Without expert knowledge the user can start right away; software wizards guide him accurately through the various screens.

This uniquely convenient solution does not only take into account electrotechnical installation requirements, but is also capable of simulating spatial conditions due to beams, additional walls and columns, and automatically takes them into account for cabling.

This is the result of many years of experience amassed by Wieland Project Support. It is possible to plan not only individual rooms, but also stories and entire buildings.

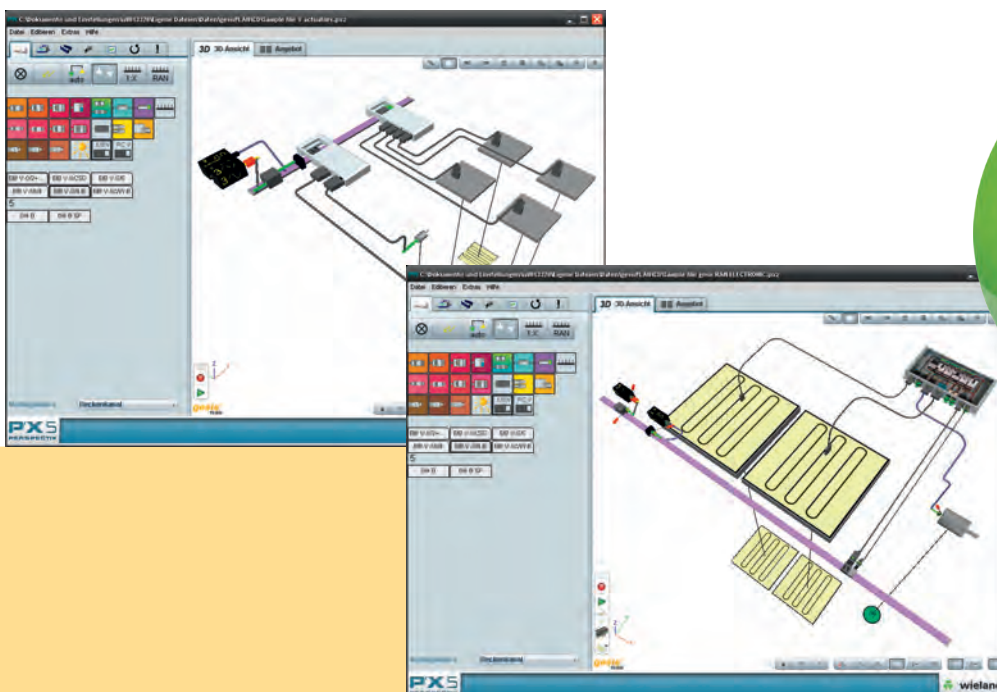



iF product design award 2014 for gesis® FLEX,

gesis® FLEX, the modular room automation system, has received the prestigious iF product design award for 2014. This award is testimony for Wieland Electric that functional electronics can have an appealing design too.

During the development of the new series, the focus was very much on practicality and a purposeful design.

The new system, which is based on the KNX standard, can be adapted by instantly adding just a few basic components to achieve the most diverse applications for room automation.

The base module can accommodate up to six extension modules with various functions. The resultant device retains its address in the KNX system, thereby using very little in the way of system resources.



gesis[®] FLEX

The future of room automation. Modular, compact, pluggable.

■ The future

Future-proof systems rely on standards. KNX has proven itself over many years, and it is established and standardized worldwide. The pluggable electrical installation with **gesis**[®] has been used successfully for decades all over the world. The combination of both proven systems prepares any building adequately for the future.

■ Modular

Architects, planners, and contractors must all take account of the conditions relating to a building. The wishes of the owners and the constraints, e.g. due to building size, regulations, location, and ultimately budget, impact on room automation. So it is essential to have automation devices that can also be adapted to these requirements. Fixed-function devices for a room can only satisfy this need to a limited extent; they are either oversized or overburdened. Modular devices where the function is easily modified by adding inputs/outputs can be adapted to requirements at any time. Even after initial installation.

■ Compact

The construction space for electrical installations is becoming increasingly confined. Utility rooms should be as small as possible, cable trays are accepted as a necessary evil, suspended ceilings are continuing to disappear, and these days installation in corridor ceilings is generally not allowed. Wieland Electric can help you out of this predicament. The **gesis**[®] installation is decentralized. The room automation devices are installed exactly where they are needed, in the rooms, which keeps the distributors small.

gesis[®] FLEX has been designed so it is easy to install in cable support systems without requiring additional construction space.

■ Pluggable

Buildings of whatever type are being erected more and more quickly. This poses a challenge for the electrical installation as well. Prefabrication to the highest possible degree enables rapid, error-free installation and prevents delays in construction. This is made possible with universally pluggable components. A flat cable can be used here with pluggable outgoing adapters for power and bus supply to the areas. The room automation devices are plugged into this, and, in turn, the consumers, such as lamps, are plugged into them. The automation devices have been pre-programmed and tested in advance by the system integrator. The electrical installation for an office is completed in no time and fits perfectly into the construction process.

Advantages of the **gesis**[®] FLEX series

- **Compactness – fits through even the smallest inspection openings into virtually any assembly area**
- **Modularity – enables adjustment to a whole range of requirements**
- **Pluggability – allows for quick and error-free installation thanks to the high degree of prefabrication**
- **Sustainability – KNX combined with modularity will make your installation future-proof**

Data for the gesis® FLEX series

Mains connection: 230 V AC or 400 V AC, depending on the base or feed module

Bus connection: KNX TP

Connection type: all electrical connections are pluggable

Module dimensions:

Height (vertically from the top edge of the top-hat rail)	all except DIN rail	44 mm
	DIN rail housing	80 / 94 mm (without / with protective cover)
Width (crossways to the top-hat rail)	all except DIN rail	149 mm
	DIN rail housing	149 / 173 mm (without / with screw fittings)
Length (along the top-hat rail)	narrow housing	95 mm mounted
	wide housing	130 mm mounted
	DIN rail housing	130 mm mounted
	side covers	approx. 30 mm in total

Installation

without top-hat rail	on flat surfaces
with top-hat rail	TH35
with mounting frame	see product part

		83.020.06000.0 / ...1	83.020.06010.0 / ...1	83.020.06100.0 / ...1	83.020.06110.0 / ...1	83.020.06220.0 / ...1	83.020.06230.0 / ...1	83.020.06240.0 / ...1	83.020.06260.0 / ...1	83.020.06270.0 / ...1	83.020.06300.0 / ...1	83.020.06280.0 / ...1	83.020.06000.0	83.020.06610	83.020.06620	83.020.06630	
Functions	gesis FLEX Modular																
	KNX Connection	x	x									x					
	Base module for x extension modules	6	6														
	Extension module for Base module					x	x	x	x	x	x						
	3-phase mains feed	x	x														
	1-phase mains feed		x	x													
	Mains power supply through upstream module					x	x	x	x	x	x		x	x	x	x	
	Binary input 12-V SELV					8											
	Switching output 230V 16A						4										
	Switching output 230V 16A C-load								4								
	Sunblind output 230V AC 8A							2									
	Sunblind output 24V DC 3A										2						
	DALI outputs for each of 16 ballasts											4					
	gesis FLEX stand-alone / dedicated KNX connection																
	EnOcean - KNX gateway channels												32				
	gesis FLEX add-on / auxiliary functions																
	Installation DIN rail 4 module widths													x	x	x	x
	Fitting cable diameter 5-9 mm														1		1
Fitting cable diameter 7-13 mm														2		2	
Hinged lid															x	x	
For functions integrated into the REG housing, see from page 19																	
Connector**)	Main supply	Three-phase, 5-pole (GST18i5 black)	1*	1*													
		Single-phase, 3-pole (GST18i5 black)		1*													
	KNX	2-pole infeed BST 14i2 green	1*	1*									1*				
		2-pole routing BST 14i2 green	1*	1*													
	In-/Outputs	5-pole (GST15i5 light blue)				2*											
		3-pole (GST18i3 black)					4*		4*								
		4-pole (GST18i4 black)						2*									
		2-pole (GST15i2 light blue)									3*						
2-pole (GST15i2 pastell blue)										4*							

* See the product range of the pluggable electrical installation system gesis® CON
Plug set included



Application example: school

Requirements

School renovations often have to be completed in the shortest time. Using pluggable installations combined with pluggable room automation devices is especially practical here. In classrooms, room automation involves controlling blinds and lighting using conventional buttons. The electrothermal actuators of the radiator valves need to be controlled via semiconductors. In addition, the blind and lighting circuits have to be fused separately.

Realization

The modular KNX system **gesis**®FLEX uses conventional buttons, controls the blinds and links the DALI luminaires to the KNX. The heating is controlled by a KNX room temperature controller, the valves are switched via a semiconductor switch. **gesis**®FLEX enables the lighting and blind circuit to be controlled separately via an intermediate power supply.

Used automation devices:

1 x base module, 1-phase	gesis KNX FLEX-BAS SP
1 x binary input, 8-fold	gesis FLEX-8/0 (12)
1 x DALI output 4x16-fold	gesis FLEX-0/4 DA
1 x semiconductor switch	gesis FLEX DRA-0/4 H
1 x intermediate power supply	gesis FLEX-MS SP
2 x blind output	gesis FLEX-0/2W
1 x room temperature controller	gesis KNX RTR SP

Used connection elements:

- Three-phase to one-phase distribution block (GST18i5 to GST18i3) for the power supply system to the base module and the mains supply to the DALI luminaires
- Y-conductor for bundling the DALI signal from the **gesis**®FLEX system and the mains supply
- Standard conductors and connectors from the GST18, GST15 and BST 14 systems

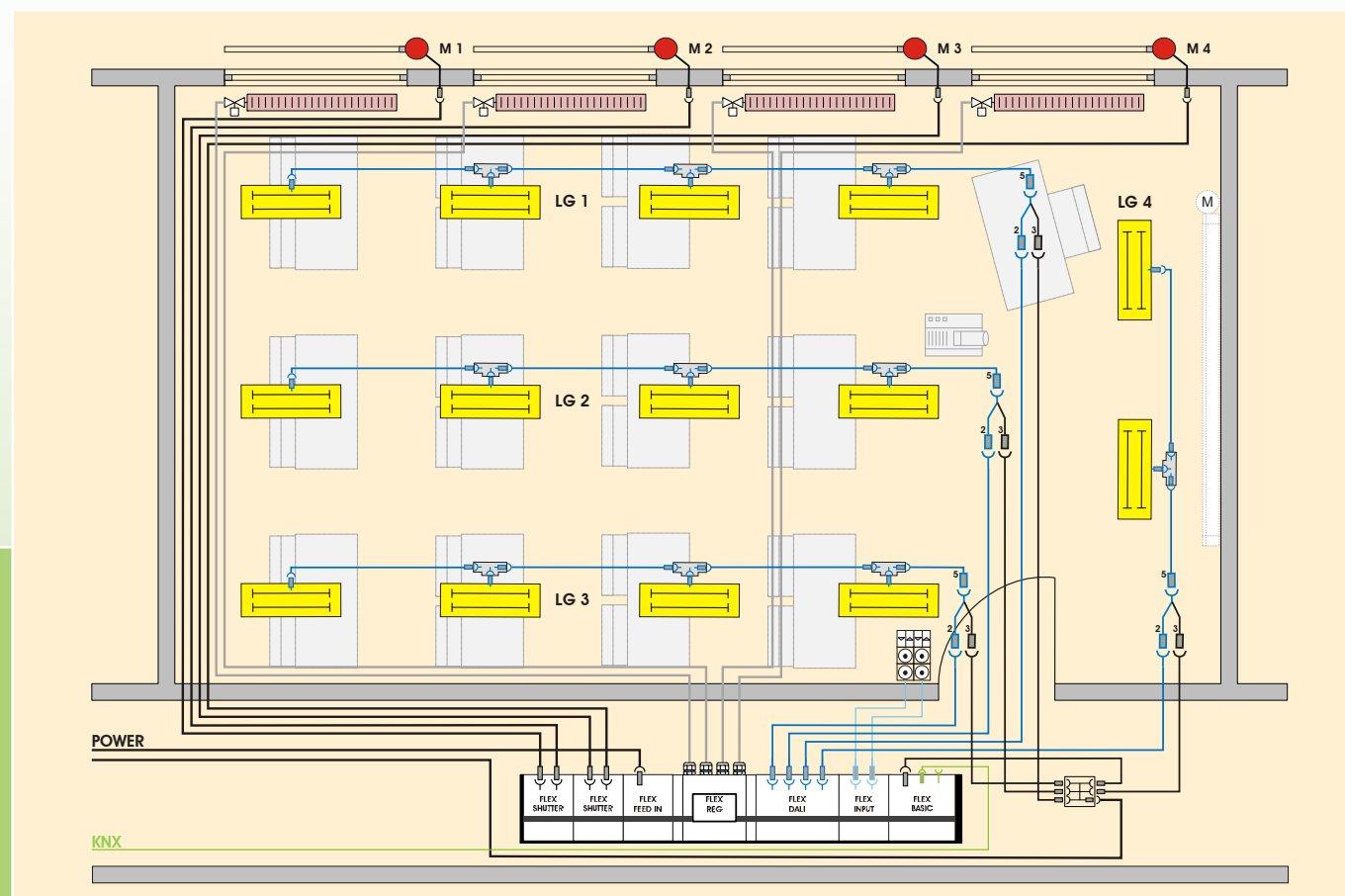

Feeds 1-phase or 3-phase



3-phase:

The base modules and intermediate feeds are designed for 3-phase 230/400V connection. This is necessary for connecting high loads to the extension modules. If various feeds should be used, this can be achieved via an intermediate feed. The outputs of the extension modules are hard-wired to the fed outer conductors. E.g. switching output 4-fold output A1-L1; A2-L2; A3-L3; A4-L3.



1-phase:

Feeds with 1-phase mains connection are used if the connected power is low. The through-wiring within a **gesis**[®] FLEX arrangement is always designed as 3-phase. Single-phase feed modules bridge the three live conductors. The connected extension modules are thereby connected to an outer conductor. E.g. switching output 4-fold output 1 – 4 on the connected outer conductor.

With or without plug set



Without plug set:

The **gesis**[®] FLEX series offers pluggable electrical connections throughout. The corresponding plugs come from different **gesis**[®] product lines depending on their use. If a pluggable electrical installation is planned for the entire building project and therefore industrially prefabricated **gesis**[®] cables are also used, the model without accompanying connectors is recommended.

With plug set:

If the devices are operated in single applications or a universally pluggable electrical installation is not planned, then choose the model with a plug set. You will receive the devices including all the connectors required for connection. These have a screw or spring connection and are suitable for all common cable types.

KNX base modules 3-phase feed



Type	Std. Pack	Part No.
gesis KNX FLEX-BAS without plug set	10	83.020.0600.0
gesis KNX FLEX-BAS Z with plug set	1	83.020.0600.1 1 mains feed 5-pole GST18i5, black 1 bus feed 2-pole, BST14i2, green

The 3-phase supplied KNX base module with flat surface mounted housing, which can be fitted on DIN rails for decentralized installation, supports 6 expansion modules. They support all the common inputs and outputs, and they provide extensive room automation with only one physical address. The manual operation level allows function tests without prior system integration. The electrical connections, which are pluggable in accordance with IEC 61535, separate automation and installation. For 83.020.0600.1: all necessary plugs are enclosed.

Feed
Mains 230/400V; 3 x 16A
Bus KNX TP1

Outputs
Mains and bus connection to next module

Dimensions
length: 117 mm with left cover
width: 149 mm incl. plug lock
height: 44 mm without mounting rail

Installation
surface-mounted on TH35 mounting rail, system-compatible mounting frame or flat mounting surface

Accessories
extension modules from the **gesis®** FLEX series
mounting frame, see page 24
plug-in connectors, see page 84

KNX base modules 1-phase feed



Type	Std. Pack	Part No.
gesis KNX FLEX-BAS SP without plug set	10	83.020.0601.0
gesis KNX FLEX-BAS SP Z with plug set	1	83.020.0601.1 1 mains feed 3-pole GST18i3, black 1 bus feed 2-pole, BST14i2, green

The 3-phase supplied KNX base module with flat surface mounted housing, which can be fitted on DIN rails for decentralized installation, supports 6 expansion modules. They support all the common inputs and outputs, and they provide extensive room automation with only one physical address. The manual operation level allows function tests without prior system integration. The electrical connections, which are pluggable in accordance with IEC 61535, separate automation and installation. For 83.020.0601.1: all necessary plugs are enclosed.

Feed
Mains 230V; 16A
Bus KNX TP1

Outputs
Mains and bus connection to next module

Dimensions
length: 117 mm with left cover
width: 149 mm incl. plug lock
height: 44 mm without mounting rail

Installation
surface-mounted on TH35 mounting rail, system-compatible mounting frame or flat mounting surface

Accessories
extension modules from the **gesis®** FLEX series
mounting frame, see page 24
plug-in connectors, see page 84

Power supply module 3-phase

Type	Std. Pack	Part No.
gesis FLEX-MS without plug set	10	83.020.0610.0
gesis FLEX-MS Z with plug set	1	83.020.0610.1 1 mains feed 5-pole GST18i5, black

The 3-phase power supply module with flat surface mounted housing, which can be fitted on DIN rails for decentralized installation, allows a mains supply separate from the base module within a modular system. This means that the output loads can be split over different fuse circuits. It can be integrated in the system as often as required. The electrical connections, which are pluggable in accordance with IEC 61535, separate automation and installation. For 83.020.0610.1: all necessary plugs are enclosed.

Feed	
Mains	230/400V; 3 x 16A
Bus	from preceding module
Outputs	
Mains and bus connection	to next module
Dimensions	length: 95 mm (mounted) width: 149 mm incl. plug lock height: 44 mm without top-hat rail
Installation	surface-mounted on TH35 mounting rail, system-compatible mounting frame or flat mounting surface
Accessories	extension modules from the gesis [®] FLEX series mounting frame, see page 24 plug-in connectors, see page 84

Power supply module 1-phase

Type	Std. Pack	Part No.
gesis FLEX-MS SP without plug set	10	83.020.0611.0
gesis FLEX-MS SP Z with plug set	1	83.020.0611.1 1 mains feed 3-pole GST18i3, black

The 1-phase power supply module with flat surface mounted housing, which can be fitted on DIN rails for decentralized installation, allows a mains supply separate from the base module within a modular system. This means that the output loads can be split over different fuse circuits. It can be integrated in the system as often as required. The electrical connections, which are pluggable in accordance with IEC 61535, separate automation and installation. For 83.020.0611.1: all necessary plugs are enclosed.

Feed	
Mains	230V; 16A
Bus	from preceding module
Outputs	
Mains and bus connection	to next module
Dimensions	length: 95 mm (mounted) width: 149 mm incl. plug lock height: 44 mm without top-hat rail
Installation	surface-mounted on TH35 mounting rail, system-compatible mounting frame or flat mounting surface
Accessories	extension modules from the gesis [®] FLEX series mounting frame, see page 24 plug-in connectors, see page 84

Binary inputs 8-fold

Type	Std. Pack	Part No.
gesis FLEX-8/0 (12) without plug set	10	83.020.0622.0
gesis FLEX-8/0 (12) Z with plug set	1	83.020.0622.1 2 plugs, each for 4 inputs 5-pole GST15i5, light blue

The 8-fold binary input 12 VDC, for connecting potential-free contacts, with flat surface mounted housing which can be fitted on in DIN rail for decentralized installation, is managed by the base module. It receives mains and bus supply from the upstream module. The extensive parameter set enables different automation functions. The manual operation level allows function tests without prior system integration. The electrical connections, which are pluggable in accordance with IEC 61535, separate automation and installation. For 83.020.0622.1: all necessary plugs are enclosed.

Feed	Mains and bus connection	from preceding module
Outputs	Mains and bus connection	to next module
Inputs	Mains and bus connection	8 (2x4), non-isolated 12 V SELV
Dimensions		length: 95mm mounted (105 mm with left cover) width: 149mm incl. plug lock height: 44 mm without top-hat rail surface-mounted on TH35 mounting rail, system-compatible mounting frame or flat mounting surface
Installation		extension modules from the gesis® FLEX series mounting frame, see page 24 plug-in connectors, see page 84
Accessories		

DALI output 4-fold

Type	Std. Pack	Part No.
gesis FLEX-0/4DA without plug set	10	83.020.0630.0
gesis FLEX-0/4DA Z with plug set	1	83.020.0630.1 4 plugs, GST15i2, pastel blue

The DALI output 4-fold for four separate controlled broadcast channels each for 16 DALI ballasts, with flat surface mounted housing which can be fitted on DIN rails for decentralized installation, is managed by the base module. It receives mains and bus supply from the upstream module. The extensive parameter set enables different automation functions. The manual operation level allows function tests without prior system integration. The electrical connections, which are pluggable in accordance with IEC 61535, separate automation and installation. All necessary plugs are enclosed. For 83.020.0630.1: all necessary plugs are enclosed.

Feed	Mains and bus connection	from preceding module
Outputs	Mains and bus connection	to next module
	DALI outputs	4, for each of 16 DALI EVGs all DALI EVGs connected to one output work in Broadcast mode
Dimensions	DALI plug system	GST15i2, pastel blue, female connector in the module length: 130 mm mounted (140 mm with left cover) width: 149 mm incl. plug lock height: 44 mm without top-hat rail surface-mounted on TH35 mounting rail, system-compatible mounting frame or flat mounting surface
Installation		extension modules from the gesis® FLEX series mounting frame, see page 24 plug-in connectors, see page 84
Accessories		Y-conductor DALI+mains power, see page 23 mounting frame, see page 24 plug-in connectors, see page 84

Switching outputs 4-fold

Type	Std. Pack	Part No.
gesis FLEX-0/4 without plug set	10	83.020.0623.0
gesis FLEX-0/4 Z with plug set	1	83.020.0623.1 4 outputs 3-pole GST18i3, black

The 4-fold relay output 230 V/16 A in the flat surface-mounted housing, which can be fitted on DIN rails for decentralized installation, is managed by the base module. It receives its mains supply and bus supply from the upstream module. The extensive parameter set enables different automation functions. The manual operation level allows function tests without prior system integration. The electrical connections, which are pluggable in accordance with IEC 61535, separate automation and installation. For 83.020.0623.1: all necessary plugs are enclosed.

Feed Mains and bus connection	from preceding module
Outputs Mains and bus connection Relay output	to next module 4, non-isolated 230V/16A width: 130 mm mounted (140 mm with left cover) height: 149 mm incl. plug lock depth: 44 mm without top-hat rail
Dimensions	surface-mounted on TH35 mounting rail, system-compatible mounting frame or flat mounting surface
Installation	extension modules from the gesis® FLEX series mounting frame, see page 24
Accessories	plug-in connectors, see page 84

Switching output 4-fold C-load

Type	Std. Pack	Part No.
gesis FLEX-0/4P without plug set	10	83.020.0626.0
gesis FLEX-0/4P Z with plug set	1	83.020.0626.1 4 plugs, GST18i3, black

The 4-fold C-load relay output 230 V/16 A, with flat surface mounted housing which can be fitted on DIN rails for decentralized installation, is managed by the base module. It receives mains and bus supply from the upstream module. The extensive parameter set enables different automation functions. The manual operation level allows function tests without prior system integration. The electrical connections, which are pluggable in accordance with IEC 61535, separate automation and installation. For 83.020.0626.1: all necessary plugs are enclosed.

Feed Mains and bus connection	from preceding module
Outputs Mains and bus connection Relay output	to next module 4, each 16 A 140 µF inrush and starting currents
Plug system	GST 18i3, black, female connector in the module
Dimensions	length: 130 mm mounted (140 mm with left cover) width: 149 mm incl. plug lock height: 44 mm without top-hat rail
Mounting	surface-mounted on TH35 mounting rail, system-compatible mounting frame or flat mounting surface
Accessories	base and extension module from the gesis® FLEX series mounting frame, see page 24 connector, see from page 84

Sunblind output 2-fold AC

Type	Std. Pack	Part No.
gesis FLEX-0/2W without plug set	10	83.020.0624.0
gesis FLEX-0/2W Z with plug set	1	83.020.0624.1 2 outputs 4-pole GST18i4, black

The 2-fold shutter output 230 V/8 A, with flat surface mounted housing which can be fitted on in DIN rail for decentralized installation, is managed by the base module. It receives mains and bus supply from the upstream module. The parameter set enables different automation functions. The manual operation level allows function tests without prior system integration. The electrical connections, which are pluggable in accordance with IEC 61535, separate automation and installation. For 83.020.0624.1: all necessary plugs are enclosed.

Feed Mains and bus connection	from preceding module
Outputs Mains and bus connection	to next module
Dimensions	width: 130 mm mounted (140 mm with left cover) height: 149 mm incl. plug lock depth: 44 mm without top-hat rail
Installation	surface-mounted on TH35 mounting rail, system-compatible mounting frame or flat mounting surface
Accessories	extension modules from the gesis® FLEX series mounting frame, see page 24 plug-in connectors, see page 84

Sunblind output 2-fold DC

Type	Std. Pack	Part No.
gesis FLEX-0/2W DC without plug set	10	83.020.0627.0
gesis FLEX-0/2W DC Z with plug set	1	83.020.0627.1 2 plugs, GST15i2, light blue 1 female, GST15i2 light blue

The 2-fold shutter output 24 V DC/3 A, with flat surface mounted housing which can be fitted on in DIN rail for decentralized installation, is managed by the base module. It receives the internal supply from the upstream module. The 24V supply is externally. The parameter set enables different automation functions. The electrical connections, which are pluggable in accordance with IEC 61535, separate automation and installation. For 83.020.0627.1: all necessary plugs are enclosed.

Feed Mains and bus connection	from preceding module
Outputs Mains and bus connection Power supply system for blind drives Blind outputs	to next module 24VDC, 6A, GST15i2, light blue, male connector in the module 2, DC after input voltage, 3 A rotational direction changed by reversing the poles
Plug system	GST15i2, light blue, 2 x female/1 x male
Dimensions	length: 95 mm mounted (105 mm with left cover) width: 149 mm incl. male lock height: 44 mm without top-hat rail
Mounting	surface-mounted on TH35 mounting rail, system-compatible mounting frame or flat mounting surface
Accessories	base and extension modules from the gesis® FLEX series mounting frame, see page 24 connector, see from page 84

EnOcean Gateway

Type	Std. Pack	Part No.
gesis FLEX-ENO32 without plug set	10	83.020.0628.0
gesis FLEX-ENO32 Z with plug set	1	83.020.0628.1 Female and male, BST14i2 (KNX)

The bi-directional gateway for 32 channels is an autonomous KNX device in the AP housing that can be mounted on the mounting rail for decentralized installation. The gateway is oriented towards the EnOcean Equipment Profiles (EEP). Besides the commissioning software, convenient manual operation via a display is also available. The ETS application has, in addition, an extensive logic/control range. The KNX connection is designed to be pluggable. For 83.020.0628.1, the male set is included.

Infeed Bus connection KNX EnOcean signals	BST14i2, green male connector in the module 32 channels, can be switched to bi-directional, all current EEPs
Output Bus connection KNX EnOcean signals	BST14i2, green female connector in the module 32 channels, can be switched to bi-directional, all current EEPs
Dimensions	Length: 126 mm (can be mounted on gesis® FLEX modules) Width: 144 mm height: 44 mm without top-hat rail
Mounting	surface-mounted on TH35 mounting rail, system-compatible mounting frame or flat mounting surface
Accessories	Base and extension module from the gesis® FLEX series mounting frame, see page 24 connector, see from page 84

DIN rail system housing for 4 module widths

Type	Std. Pack	Part No.
gesis FLEX-REG4	1	83.020.0660.0
gesis FLEX-REG4 V	1	83.020.0661.0
gesis FLEX-REG4 D	1	83.020.0662.0
gesis FLEX-REG4 DV	1	83.020.0663.0

The system-compatible housing module for DIN rail surface mounting for decentralized installation can be used to install DIN rail mounted devices according to DIN 43880 with up to four module width. Mains and bus supply are passed from upstream to downstream module. Main supply can be internally gripped. Depending on the variant, a clear cover to protect the internal device is mounted, cable glands already integrated or on site contributed.

Installation option height / width / depth	rail-mounted devices according to DIN 43880 90 mm (crossways to the top-hat rail) / 4 module widths (72 mm) / open to the top
Feed	mains from the preceding module can be tapped internally
Through-wiring	mains and bus routing from preceding module to next module
Dimensions	length: 130 mm mounted (140 mm with left cover) width: 140 mm height: 80 mm without top-hat rail
Installation	surface-mounted on TH35 mounting rail, system-compatible mounting frame or flat mounting surface

DALI Gateway **gesis® FLEX REG**

Type	Std. Pack	Part No.
 <p>gesis FLEX-REG 0/64 DA housing device</p>	1	G0.000.0666.8 gesis FLEX REG4 without transparent cover Siemens / DALI Gateway N 141/02
<p>The DALI Gateway (SIEMENS, DALI Gateway N141/02) is an independent KNX device, the surface mounted housing can be fitted on DIN rails for decentralized installation. It may take up to 64 DALI ECGs individually and in control groups. It can be linked to the gesis® FLEX system. The module receives its power supply from an upstream gesis® FLEX module. The KNX connection is pluggable. All connections to the DALI devices are pluggable according to IEC 61535 and separate automation and installation.</p>		
<p>Connections KNX Connection Mains connection DALI</p> <p>Functions: DALI</p> <p>Manual operating level</p> <p>Dimensions (excluding conductors)</p> <p>Mounting</p> <p>Accessories</p>	<p>all connections pluggable with approx. 30cm conductor length</p> <p>BST14i2 male connector on the module</p> <p>230 / 400 V from the upstream gesis® FLEX module</p> <p>1 x GST18i5 pastel blue</p> <p>64 DALI actuators with > 8kOhm input impedance individual and group addressing emergency lighting activation possible button for Broadcast operation length: 130 mm mounted width: 173 mm included screwed joints height: 80 mm without top-hat rail surface-mounted on TH35 mounting rail, systemcompatible mounting frame or flat mounting surface modules from the gesis® FLEX series mounting frame, see page 24</p>	

Switch-/dimming output **gesis® FLEX REG**

Type	Std. Pack	Part No.
 <p>gesis FLEX-REG 0/2 SD housing device</p>	1	83.020.0667.0 gesis FLEX REG4 without transparent cover ABB SD/S2.16.1
<p>The switch-/dimming output (ABB SD/S2.16.1) is an independent KNX device, the surface mounted housing can be fitted on DIN rails for decentralized installation. It can connect two separate groups of luminaires with dimmable electronic ballasts and dimming by means of 1-10V signal. It can be linked to the gesis® FLEX system. The module receives its power supply from an upstream gesis® FLEX module. The KNX connection is pluggable. All connections to the luminaires are pluggable according to IEC 61535 and separate automation and installation.</p>		
<p>Connections KNX Connection Mains connection Luminaire connection</p> <p>Functions Control output 1-10V Switching output Manual operating level</p> <p>Dimensions (excluding conductors)</p> <p>Mounting</p> <p>Accessories</p>	<p>All connections pluggable with approx. 30cm conductor length</p> <p>BST14i2 male connector on the module</p> <p>230 / 400 V from the upstream gesis® FLEX module</p> <p>2 x GST18i5 pastel blue</p> <p>max 100 mA, typical 50 dynamic EVGs 230 V AC / 16 A AC1 or 10 A AX button for Broadcast operation length: 130 mm mounted width: 173 mm included screwed joints height: 80 mm without top-hat rail surface-mounted on TH35 mounting rail, systemcompatible mounting frame or flat mounting surface modules from the gesis® FLEX series mounting frame, see page 24</p>	

SMI Gateway **gesis® FLEX REG**

Type	Std. Pack	Part No.
 <p>gesis FLEX REG SMI housing device</p>	1	G0.000.0666.9 gesis FLEX REG4 without transparent cover ABB JA/S4.SMI.1M
<p>The SMI Gateway (ABB JA/S4.SMI.1M) is an independent KNX device, the surface mounted housing can be fitted on DIN rails for decentralized installation. It may take up to 4 SMI groups with up to 4 drives each. A manual control allows you to directly control the device. It can be linked to the gesis® FLEX system. The module receives its power supply from an upstream gesis® FLEX module. The KNX connection is pluggable. All connections to the SMI drives are pluggable according to IEC 61535 and separate automation and installation.</p>		
<p>Connections</p> <p>KNX Connection</p> <p>Mains connection</p> <p>SMI</p> <p>Functions:</p> <p>SMI</p> <p>Manual operating level</p> <p>Dimensions (excluding conductors)</p>		<p>All connections pluggable with approx. 30 cm conductor length</p> <p>BST14i2 male connector on the module</p> <p>230 / 400 V from the upstream gesis® FLEX module</p> <p>4 x RST15i5 pastel blue (mains and SMI signal)</p> <p>4 groups</p> <p>4 x 230 V SMI drives for each group</p> <p>Buttons per group</p> <p>Length: 130 mm mounted</p> <p>Width: 173 mm included screwed joints</p> <p>Height: 80 mm without top-hat rail</p> <p>surface-mounted on TH35 mounting rail, systemcompatible mounting frame or flat mounting surface</p> <p>Modules from the gesis® FLEX series</p> <p>mounting frame, see page 24</p> <p>Connector, see from page 84</p>
<p>Mounting</p> <p>Accessories</p>		

Semi-conductor **gesis® FLEX REG 0/4 H**

Type	Std. Pack	Part No.
 <p>gesis FLEX-REG 0/4 H housing device</p>	1	G0.000.0666.6 gesis FLEX REG4 without transparent cover ABB ES/S4.1.2.1
<p>The 4-fold semiconductor switch (ABB ES/S4.1.2.1) is an independent KNX device, the surface mounted housing can be fitted on DIN rails for decentralized installation. It can be linked to the gesis® FLEX system. The module receives its power supply from an upstream gesis® FLEX module. The KNX connection is pluggable. All connections to the loads are pluggable according to IEC 61535 and separate automation and installation.</p>		
<p>Connections</p> <p>KNX Connection</p> <p>Power supply system for semiconductor inputs</p> <p>Connection for semiconductor outputs</p> <p>Functions</p> <p>Output</p> <p>Nominal voltage</p> <p>Switching power</p> <p>Manual operating level</p> <p>Dimensions (excluding conductors)</p>		<p>All connections pluggable with approx. 30 cm conductor length</p> <p>BST14i2 male connector on the module</p> <p>GST15i2 white</p> <p>4 x GST15i2 white</p> <p>Semiconductor, non-isolated, short-circuit protected</p> <p>230 V AC/DC +/-10 %, 45...65 Hz</p> <p>1 A Ohmic load with Tu up to 45 °C</p> <p>8 A for max. 1 second with Tu at 20 °C</p> <p>Button for Broadcast operation</p> <p>Length: 130 mm mounted</p> <p>Width: 173 mm included screwed joints</p> <p>Height: 80 mm without top-hat rail</p> <p>surface-mounted on TH35 mounting rail, systemcompatible mounting frame or flat mounting surface</p> <p>Modules from the gesis® FLEX series</p> <p>mounting frame, see page 24</p> <p>Connector, see from page 84</p>
<p>Mounting</p> <p>Accessories</p>		

Analog input **gesis® FLEX REG**

Type	Std. Pack	Part No.
gesis FLEX REG 8/0 AE housing device	1	G0.000.0667.0 gesis FLEX REG4 without transparent cover ABB AE/S4.2



The 4-fold analog input (ABB AE/S4.2) is an independent KNX device, the surface mounted housing can be fitted on DIN rails for decentralized installation. It can capture four analog input signals from commercially available sensors. It can be linked to the **gesis® FLEX** system. The module receives its power supply from an upstream **gesis® FLEX** module. The KNX connection and all connections to the sensors are pluggable and separate automation and installation.

Connections
 KNX Connection: BST14i2 male connector on the module
 Mains connection: 230 V from the upstream **gesis® FLEX** module
 Analog inputs: 4 x BST14i3 white

Functions
 Input: Parameterizable sensor type
 Input resistance for voltage detection: > 50 kOhm
 Input resistance for current detection: 260 Ohm

Dimensions (excluding conductors)
 Length: 130 mm mounted
 Width: 173 mm included screwed joints
 Height: 80 mm without top-hat rail

Mounting
 surface-mounted on TH35 mounting rail, systemcompatible mounting frame or flat mounting surface

Accessories
 Modules from the **gesis® FLEX** series
 mounting frame, see page 24
 Connector, see from page 84

Fan Coil **gesis® FLEX REG**

Type	Std. Pack	Part No.
gesis FLEX-REG FC 1-3 housing device	1	G0.000.0667.1 gesis FLEX REG4 without transparent cover Theben FCA 1 KNX



The FanCoil actuator (THEBEN FCA 1 KNX) is an independent KNX device, the surface mounted housing can be fitted on DIN rails for decentralized installation. It can control a complete FanCoil unit for 2 or 4 pipe systems, fan coil, electrical heater/cooler bank and sensor connections. It can be linked to the **gesis® FLEX** system. The module receives its power supply from an upstream **gesis® FLEX** module. The KNX connection and all further electrical connections are pluggable and separate automation and installation.

Connections
 KNX Connection: BST14i2 male connector on the module
 Mains connection: 230 / 400 V from the upstream **gesis® FLEX** module
 Fan: GST18i5 black
 Temperature/dew point sensor: BST 14i3 black / white
 Heating/cooling valve: GST15i2 white / black
 Post-heating coil: GST15i2 white / black

Functions
 Heating/cooling system: 2 or 4 pipe systems with 2-piece valves
 Fan: three steps / 230 V, 8 A
 Dew point/temperature sensor: potentialfree contact / sensor Theben 9070321
 auxiliary heating /cooling coil: switching contact 230 V / 16 A
 Manual operating level: yes

Dimensions (excluding conductors)
 Length: 130 mm mounted
 Width: 173 mm included screwed joints
 Height: 80 mm without top-hat rail

Mounting
 surface-mounted on TH35 mounting rail, systemcompatible mounting frame or flat mounting surface

Accessories
 Modules from the **gesis® FLEX** series
 mounting frame, see page 24
 Connector, see from page 84

Power supply unit 24 V, 2.4 A **gesis® FLEX REG**

Type	Std. Pack	Part No.
 <p>gesis FLEX REG PS24-2.5 housing device</p>	1	G0.000.0667.2 gesis FLEX REG4 without transparent cover Wieland Schaltnetzteil wipos PB1 24-2.5
<p>The power supply is used to supply 24 V DC consumers, the surface mounted housing can be fitted on DIN rails for decentralized installation. It is not suitable as a KNX power supply. It can be linked to the gesis® FLEX system. The module receives its power supply from an upstream gesis® FLEX module. The output is pluggable according to IEC 61535 and separates automation and installation.</p>		
<p>Connections</p> <p>Mains connection Output voltage Output current</p> <p>Dimensions (excluding conductors)</p>		<p>All connections pluggable with approx. 30 cm conductor length 230 from the upstream gesis® FLEX module 24 V DC (adjustable to 28 V DC) 2,5 A</p> <p>Length: 130 mm mounted Width: 173 mm included screwed joints Height: 80 mm without top-hat rail surface-mounted on TH35 mounting rail, systemcompatible mounting frame or flat mounting surface</p>
<p>Mounting</p>		<p>Modules from the gesis® FLEX series mounting frame, see page 24 Connector, see from page 84</p>
<p>Accessories</p>		

FI/LS combination **gesis® FLEX REG**

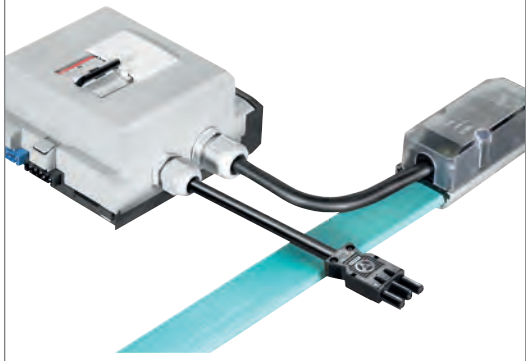
Type	Std. Pack	Part No.
 <p>gesis FLEX-REG FI_LS housing device</p>	1	G0.000.0667.3 gesis FLEX REG4 without transparent cover ABB DS201 B16 0,03A
<p>The RCCB/MCB combination with the flat cable tap for Wieland 10 mm² flat cable is used for decentralized fuse, the surface mounted housing can be fitted on DIN rails for decentralized installation. It can be mechanically linked to the gesis® FLEX system and forwards gesis® FLEX bus and mains to downstream module. The fused output is pluggable according to IEC 61535 and separates automation and installation.</p>		
<p>Connections</p> <p>Input</p> <p>Connection cable input Nominal current Leakage current I_{Δn} Circuit breaker characteristics</p> <p>Output</p> <p>Manual operating level</p> <p>Dimensions (excluding conductors)</p>		<p>Flat cable adapter 10mm² Wieland 92.050.8353.0 Tap-off L1 on flat cable adapter, can be modified to L2/L3 1,5 m / 4 mm² 16 A 30 mA B 1 x GST18i3 black Button for Broadcast operation</p> <p>Length: 130 mm mounted Width: 173 mm included screwed joints Height: 80 mm without top-hat rail surface-mounted on TH35 mounting rail, systemcompatible mounting frame or flat mounting surface</p>
<p>Mounting</p>		<p>Modules from the gesis® FLEX series mounting frame, see page 24 Connector, see from page 84</p>
<p>Accessories</p>		

System extensions mains

Type	Std. Pack	Part No.
Mains extension 0.5 m	1	91.257.0500.2
Mains extension 1.0 m	1	91.257.1000.2

The mains extension for the flat surface-mounted module system for decentralized installation, which can be mounted on a mounting rail, may have a length of no more than one meter in the system. It locks automatically upon insertion. The mechanical coding means that the mains connection cannot be confused with the bus connection.

Mains extension

Nominal voltage	230/400 V
Nominal current	3 x 16 A
Connector system	GST15i5 white

Installation insert and lock with the **gesis**[®]FLEX modules

System extensions bus

Type	Std. Pack	Part No.
Bus extension 0.5 m	1	99.400.9999.8
Bus extension 1.0 m	1	99.401.9999.8

The extension of the internal bus for the flat surface-mounted module system for decentralized installation, which can be mounted on a mounting rail, may have a length of no more than one meter in the system. It locks automatically upon insertion. The mechanical coding means that the mains connection cannot be confused with the bus connection.

Mains extension

Nominal voltage	50 V
Nominal current	10 A
Connector system	GST15i5 light blue

Installation insert and lock with the **gesis**[®]FLEX modules

Y-conductor for DALI applications

Type	Std. Pack	Part No.
PVC conductor 0.5 m	1	99.404.9999.8
Halogen-free conductor 0.5 m	1	99.405.9999.8

The Y-conductor for DALI applications allows the DALI signal and the mains supply to be fed separately into a common connector. The further light wiring is then effected via the common connector system. The conductor is used, e.g. for the **gesis**[®]FLEX DALI output.

Connectors

DALI male connector	GST15i2 pastel blue, Code 2, D1 / D2
Mains male connector	GST18i3 black, Code 1, L / PE / N
DALI+mains female connector	GST18i5 pastel blue, Code 2, L / N / PE / D1 / D2

Mounting frame

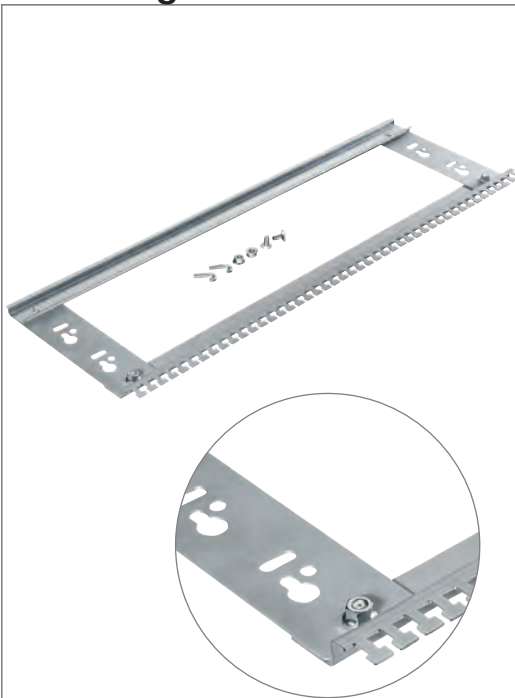

Type	Std. Pack	Part No.
Mounting frame	40 cm	1 Z5.524.1410.0
	50 cm	1 Z5.524.1510.0
	60 cm	1 Z5.524.1610.0
	70 cm	1 Z5.524.1710.0
	80 cm	1 Z5.524.1810.0
	90 cm	1 Z5.524.1910.0
	100 cm	1 Z5.524.2010.0

The mounting aid for the flat surface-mounted module system for decentralized installation, which can be mounted on a mounting rail, simplifies installation on cable support systems, ceilings, or walls. It accommodates up to six modules and has attachments for all incoming/outgoing cables. The hole pattern and supplied screws enable quick assembly.

Installation

in cable duct with accompanying flat-head screws
on mesh cable trays with accompanying clip bolts
screw fastening to other substrates

**Mounting rail
Attachment of the cables
Dimensions**

TH35 integrated
with cable ties to the hammer head profile
width: see above
height: 230 mm
depth: 15 mm

Number of modules and suggested length of the mounting frame

Base module + covers + installation	Binary input or intermediate feed	Switching, sunblind or DIN rail housing	Mounting frame length in cm	Order number
195 mm	95 mm	130 mm		
1	0	1	40	Z5.524.1410.0
1	0	2	50	Z5.524.1510.0
1	0	3	60	Z5.524.1610.0
1	0	4	80	Z5.524.1810.0
1	0	5	90	Z5.524.1910.0
1	0	6	100	Z5.524.2010.0
1	1	0	40	Z5.524.1410.0
1	1	1	50	Z5.524.1510.0
1	1	2	60	Z5.524.1610.0
1	1	3	70	Z5.524.1710.0
1	1	4	90	Z5.524.1910.0
1	1	5	100	Z5.524.2010.0
1	2	0	40	Z5.524.1410.0
1	2	1	50	Z5.524.1510.0
1	2	2	70	Z5.524.1710.0
1	2	3	80	Z5.524.1810.0
1	2	4	100	Z5.524.2010.0
1	3	0	50	Z5.524.1510.0
1	3	1	60	Z5.524.1610.0
1	3	2	80	Z5.524.1810.0
1	3	3	90	Z5.524.1910.0
1	4	0	60	Z5.524.1610.0
1	4	1	70	Z5.524.1710.0
1	4	2	90	Z5.524.1910.0
1	5	0	70	Z5.524.1710.0
1	5	1	80	Z5.524.1810.0

Covers

	Type	Std. Pack	Part No.
	Set with two covers	1	99.061.9999.9
<p>The covers serve to close gesis[®] FLEX devices or device arrangements on the left and right sides. They are included with base modules. If, for example, a gesis[®] FLEX housing is operated in isolation or only via Feed in Module, we recommend the use of protective caps.</p>			
<p>Mounting</p>		<p>Connecting and locking on the gesis[®] FLEX modules</p>	

Recommendation: Space for labels

	<p>gesis[®] FLEX devices offer enough space to place documentation on the device between labels. We recommend A4 label sheets with individual labels up to a dimension of 30x 90 mm. Manufacturers often offer templates or proprietary software tools that permit effective labeling.</p> <p>Example: Avery customized label 70 x 26.7 mm, 30 pieces on A4 sheet Art. no. Avery customized label 3489</p>
--	--



Energy savings

gesis[®] uses the energy savings potential of the building.

The following can be monitored:

- presence/absence
- actual and target parameters
- demand-based regulation
- time-based controls



Renovation of the Max Planck Secondary School in Munich

The school building was renovated to improve its energy efficiency. This had to be done during the school holidays. The installation column was completely pre-assembled, making possible to finish the renovation within the 6 weeks of summer holidays.

The following devices are used:

- Installation column fitted, according to customer requirements, with:
 - RCCB/CB for all connections in the room
 - Overvoltage protection
 - **gesis**[®] EIB RM for sunblinds and lighting
 - **gesis**[®] EIB RM for coupling of push-buttons
 - loudspeakers and so on
- Presence detectors for constant light control



Installation column

The ideal solution for schools

Intelligent and cost-effective installation.

Sophisticated installation not only increases the efficiency of learning, it also saves money. Sophisticated room automation makes considerable cost savings possible, especially in schools. Classrooms are empty much of the time: when the students move to other classes, or have the afternoon off, and during the weekend and holidays. During these times the room automation will switch the room to energy-saving mode. And a cost-intensive complete renovation is not always required; building automation can also be achieved with a limited budget.

Considerable savings potentials.

The study "Energy efficiency with building automation" that was conducted from May 2009 until May 2011 at the University of Applied Sciences Biberach highlighted a considerable savings potential. Depending on the level of automation, savings of up to 35 % of electrical energy and even up to 70 % of heating energy could be realized. And all this with the current inventory! Without structural changes!



Facing new challenges.

A room's electrical installation has to be able to keep up with innovation. Not all that long ago, it was sufficient to have an outlet for the overhead projector and the vacuum cleaner. Today, much more is required. Ethernet connections for PCs, ELA systems for sound equipment, connections for the projector, TV connections, etc.

But do we know what will be required in 10 or 20 years' time? Cable routes, automation, and also installation clearances should be designed in such a way that future design changes can be accommodated in a low-cost and flexible way.

Wieland helps you perform your work effectively, and to all customers' satisfaction. The advantages provided at the initial installation will ensure your participation in any future modifications.

Benefits of the installation column

- Design and dimensions definable
- Complete installation space for all electrical installation devices in rooms including floor-ceiling-connection
- Delivery to the building site: pre-assembled and tested
- Short assembly times for building modifications, e.g. during school holidays
- Future-proof solution using KNX and EnOcean



gesis® INSTALLATION COLUMN

Installation and automation in one system

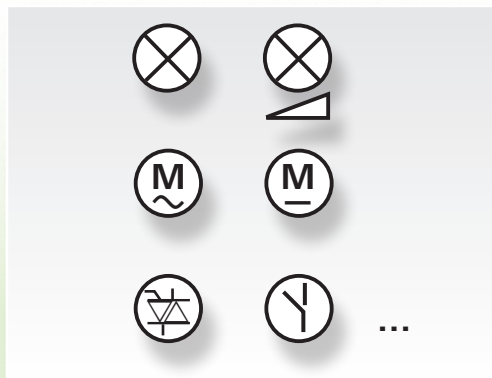

Room automation input/output gesis®RM:

- Lighting control
(switching, DALI, 1 – 10 V,
RLC dimming)
- Control of blinds (AC, DC)
- Heating control
(semiconductor outputs)
- Binary inputs
(floating, wireless)

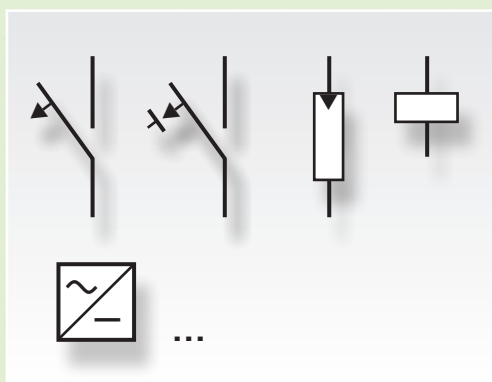

Safety and built-in units:

- Residual current circuit breakers
- Line circuit breakers
- Overvoltage protection
- Power supply units
- and a lot more ...

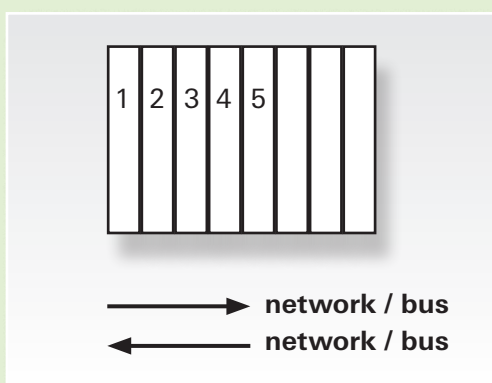

Supply and distribution:

- Network supply
- Bus system supply
- Data supply
- Enough space for installation behind the
mounting plate between ceiling and floor





Installation space for:

- Loudspeakers
- Clocks
- Breaktime bell
- Security systems
- Miscellaneous electronics

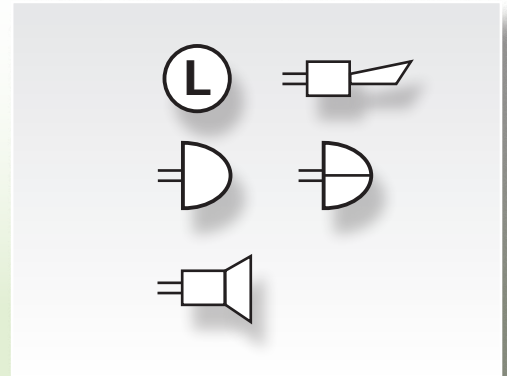

Switches and sockets:

- Hollow wall boxes, wired for
 - Media inputs (e.g. audio, PC)
 - Sockets
 - Switches
- Connection of conventional switches via push-button interfaces or binary inputs
- Switches, sockets, etc. on-site

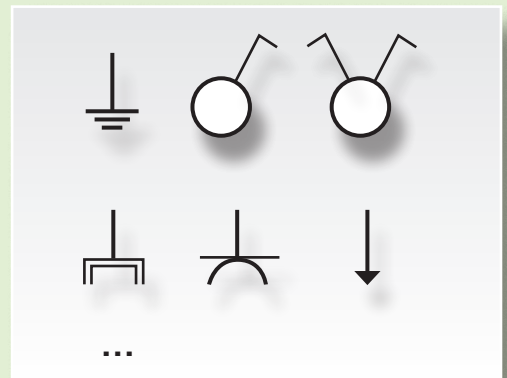

Connections into the room:

- Lighting
- Blinds
- Push-buttons
- Sensors (e.g. via bus system)
- Pluggable with **gesis**[®]CON
- Can be connected using Wieland DIN rail terminal blocks

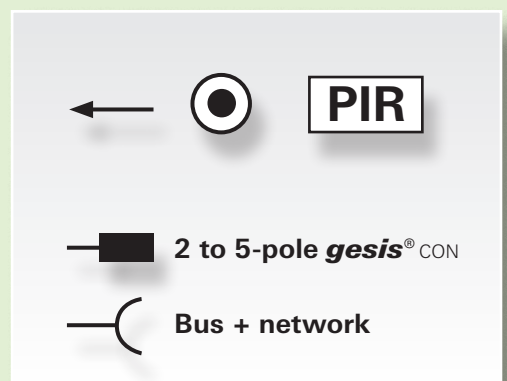

Installation column:

Standard column

- Two basic models, type A and type B
- Many detail variant models

Columns freely configurable

- Height, width, and depth to almost any specification
- Choice of colors: Cream white, light gray, graphite black, signal black, brilliant blue, white-green, further colors on request
- Interior design to any specification

Standard Column Configuration Aid

Create Your Column From Two Strong Types

Type A

Type B

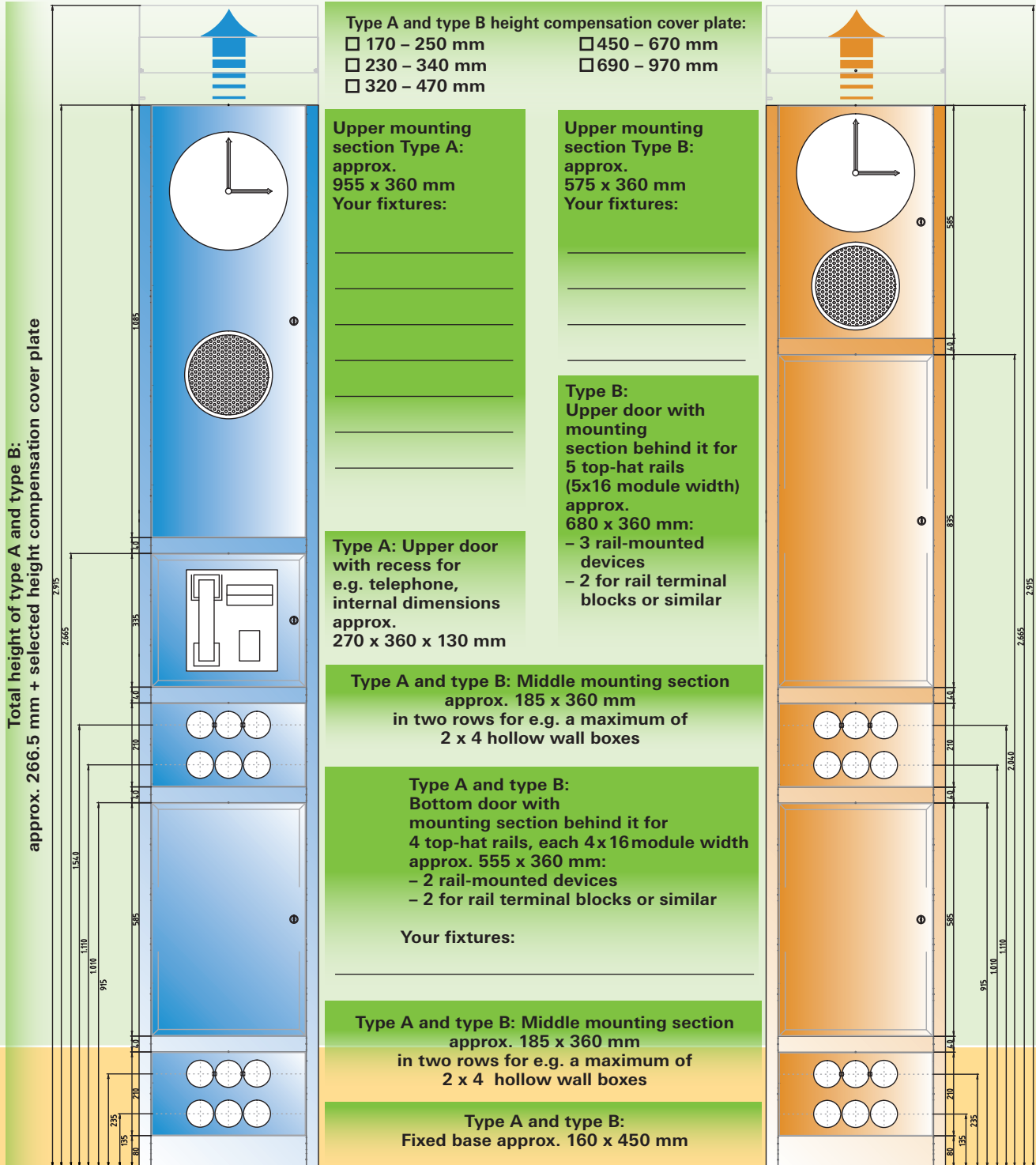

Schematic view from top approx. 450 x 200 mm



Using our configuration aid you can quickly and safely query a calculation for your applications and send it to us. You will receive a first draft of the installation column according to the information given, which will then be refined together with you in further steps. Download the Wieland optimization tools from our website, or – even more simple – get the configuration aid sent directly to your smart phone or tablet using the adjacent QR code.

We offer columns that differ from these two standard models. Please coordinate with your Wieland sales representative before ordering.

Installation Column Configuration Aid

Tick boxes or enter values

Colors (similar to RAL)

Installation column (Corpus)

cream white
(RAL 9001)

light grey
(RAL 7035)

graphite black
(RAL 9011)

signal black
(RAL 9004)

brilliant blue
(RAL 5007)

Doors

left:

right:

Electrical connections (from room to room)

Power / bus signal

Power 1-pole

Power 3-pole

Cross-section

Bus signal

Incoming supply

Distribution

Protective devices

Switches or contactors

Main switch

Number of poles:

Nominal current:

Residual current circuit breaker (40 A, 30 mA)

2-pole

4-pole

Line circuit breaker (type B)

10 A

16 A

Overvoltage protection

Network, type 2:

Network, type 3:

Bus:

Building automation

KNX

LON

Number of binary inputs

floating

radio

(EnOcean)

Lighting

Type of lighting control

switched

DALI

1 - 10V

0 - 230V AC (RLC)

Number of groups

Sunblind / blackout

Type of control

AC

DC

Number and groups

Heating control

Type of regulation

2-point

continuous

fan coil

Number of outputs

Voltage used

Other

Fixtures

e.g. power supply units, system components,
for bus topology

Amount (we will assume you need

10 pieces if this is left blank)

Project name:

Amount/desired delivery date:

Company:

Contact person:

Street/number:

Postal code/city:

Telephone/e-mail:

Send via fax: +49 951 93 26-996 or e-mail

More information online, by e-mail at bit.ts@wieland-electric.com, by telephone: +49 951 93 24-996

 www.wieland-electric.com



AMF-Bruns – Apener Maschinenbau

For over 50 years the name of AMF-Bruns, an owner-managed company, has been associated with the highest quality standards and technical knowledge in conveying systems. AMF-Bruns entrusted the Detlef Coldevey GmbH from Westerstede with the electrotechnical design and realization of a new administration building.

In this building, the lighting is efficiently managed by a Wieland KNX presence detector together with a subsidiary Dali system. By using **gesis®** consistently, the project could be realized within a very short time frame.

The following systems and devices are used:

- **gesis®** presence detectors for lighting control
- **gesis®** EIB V sunblind actuators for shading control
- flat cable system 7-pole with KNX and power for structured cabling
- LINECT Luminaire connection 5-pole for quick connection of power and DALI



gesis[®] KNX

System devices, sensors and more.

■ System devices

KNX network operation requires power supply units and line/backbone couplers as well as an interface connection to the PC for commissioning, testing or as a link between a PC-based visualization and the KNX network.

■ Motion and presence detection

Power-optimized operation of room automation requires presence and motion detectors. The detectors control or regulate the lighting system and also affect the heating, ventilation and air conditioning control with their presence messages.

■ Lighting control with DALI

The lighting control system DALI with its dimming and error message options is optimally suited to building automation. For this purpose, this sub-system must be linked to the building automation system. In addition to the actuators from the **gesis**[®] RM system the DALI gateway can be used for various connections.

■ Room thermostats and air conditioning

Optimized energy consumption in rooms requires an optimally controlled room climate. This is achieved by a combination of presence detectors and applicable room thermostats that affect the electrothermal valve controls or the corresponding actuators.

■ Integration of conventional push-buttons

Push-buttons are optimally integrated in a cost-effective manner using binary inputs. In addition to the binary inputs from the **gesis**[®] EIB M2 and **gesis**[®] EIB RM device series, push-button interfaces can be used as well.



Advantages of decentralized building automation

- Energy optimization with demand-based regulation
- High flexibility with change of use
- Considerably reduced wiring expenses
- Permanently clear cable management
- Small distribution rooms

Application example

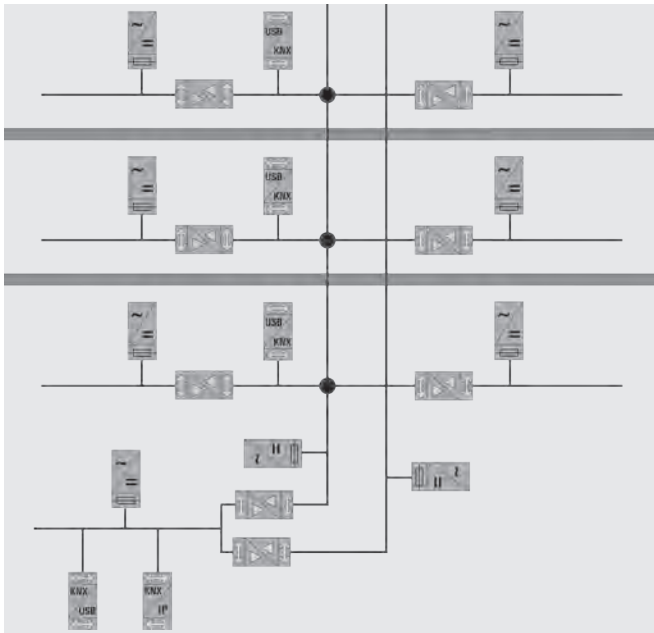

General

The internationally standardized system for home and building automation functions with multivendor devices and can be used by all trades. It is therefore excellently suited to satisfying the desire for continuously optimized power utilization in buildings.

The system has no central control. It starts with a line with max. 64 bus devices and can be extended throughout various sections up to a system with more than 14,000 bus nodes. Thus it is suitable both for small and for very large buildings.

Radio, Powerline and Twisted-Pair are available as transmission media. Due to the system characteristics the Wieland devices exclusively function with the Twisted-Pair technology on KNX side.

See the following pages describing the devices for the following topics.

		FO.000.0034.5 / FO.000.0034.6	FO.000.0034.7	FO.000.0034.8 / FO.000.0034.9	FO.000.0017.3	FO.000.0032.0	FO.000.0032.7	FO.000.0032.8	FO.000.0032.1	FO.000.0032.6	FO.000.0032.3	FO.000.0032.4	FO.000.0032.5	88.020.1404.0	88.020.1405.0	88.020.1406.0	88.020.1413.0	88.020.1414.0	88.020.1415.0	88.020.1416.0	88.020.1417.0	88.020.1418.0
Valve actuators	KNX voltage supply / mA																160	320	640			
	KNX interfaces																					
	USB <-> TP																					
	Line/backbone coupler TP/TP																					
	IP Router TP / LAN IP																					
	DALI Gateway DALI / TP																					
	Presence detectors and constant light																					
	Motion detection																					
	Standard room thermostat		q	r	r																	
	Fan coil room thermostat																					
	Fan coil output																					
	Continuous, direct KNX-TP connection																					
	Type of installation	2-point electrothermal / voltage																				
Adapter ring VAXx										24	230											
Push-button linkages / number of inputs												78	80									
DIN rail installation / MW														2	4	6						
Voltages	On / in outlet socket				4			4									4	4	4	2	2	2
	Installation hole, 64 mm diameter																					
	at heating / cooling valve																					
	KNX																					
230 V																						
24 V																						
DALI																						

*) The devices can be found in the gesis EIB V catalog sections.

**) See the product range of the pluggable electrical installation system gesis CON



Office with heating/cooling system and constant light control

Requirements

The heating and cooling function of each room is to be controlled separately. A window contact is to be integrated into the system for energy-optimizing control. The lighting is dimmed with an presence detector and the room temperature is optimized. The conventional push-buttons for controlling light and sunblinds can be integrated into the building automation via push-button interfaces.

Realization

The necessary sensors are installed in each office. The drives for the control valves are connected directly to the KNX. The outputs for the lighting and the sunblinds from the **gesis®** EIB RM series are used and installed decentrally with a **gesis®** RAN for two offices each.

The following modules are required for that:

2 x room thermostats	gesis KNXRTRSP
2 x presence detectors	gesis KNXPPSU
2 x push-button interfaces 6-fold	gesis KNXTA6/4
4 x continuous actuator with binary input	gesis KNXTHS
1 x base module KNX	gesis EIB RM2-BAS
1 x voltage supply	gesis RM-PS
2 x switching/dimming output	gesis RM-0/2SD
1 x sunblind output	gesis RM-0/2SI

Note

The controls can be modified from a central point (e.g. night mode, weekend mode). Additionally, the set values for the heating/cooling valves can be evaluated centrally to achieve perfect regulation of the primary heaters/coolers.

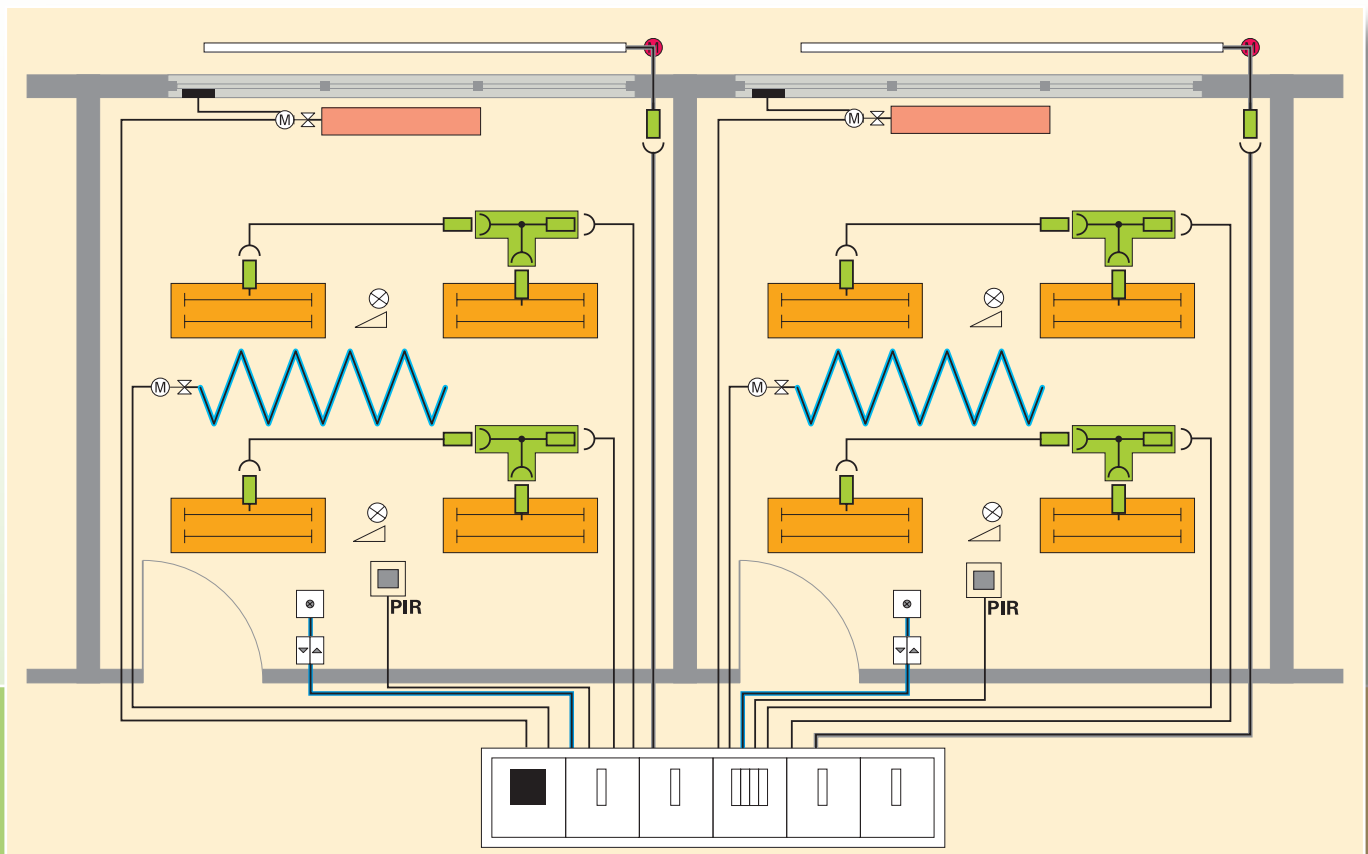

Presence detector

	Type	Part No.
	gesis KNX P PSU gesis KNX P PPU	F0.000.0034.5 F0.000.0034.6
<p>Presence detector for ceiling mounting with integrated bus coupling and mixed light measurement with a quadratic detection range (360°). With two/three outputs for controlling light groups, constant light control or switching, and two presence outputs for HLK control.</p>	Electrical data: Infeed KNX TP1 Bus coupling Integrated Detection range Horizontal 360°, vertical 120° Mixed light measurement 5 Lux - 3000 lx (gesis KNX P PPU) Maximum detection range Mounting height 3.5 m: 8 m x 8 m (PSU), 10 m x 10 m (PPU) Mounting height 2.5 m: 6 m x 6 m (PSU), 8 m x 8 m (PPU) Detection range of a seated person Mounting height 3.0 m: 5 m x 5 m (PSU), 7 m x 7 m (PPU) Mounting height 2.5 m: 4 m x 4 m (PSU), 6 m x 6 m (PPU) Ambient temperature 0 °C ... +50 °C	
	Mechanical data: Mounting Flush-mounted box 72 mm (bore hole 73 mm) Dimensions (visible) Diameter 110 mm, height 37 mm (PSU), 42 mm (PPU) Protection type IP 20 (in installed state IP40)	

Presence detector

	Type	Part No.
	gesis KNX P RPU	F0.000.0034.7
<p>Presence detector for ceiling mounting with integrated bus coupling and mixed light measurement with a round detection range (360°). With two outputs for controlling light groups, constant light control or switching, and two presence outputs for HLK control.</p>	Electrical data: Infeed KNX TP1 Bus coupling Integrated Detection range Horizontal 360°, vertical 120° Mixed light measurement 30 Lux - 3000 lx Maximum detection range Mounting height 3.5 m: 24 m diameter Mounting height 2.5 m: 23 m diameter Detection range of a seated person Mounting height 3.0 m: 8 m diameter Mounting height 2.5 m: 7 m diameter Ambient temperature -15 °C ... +50 °C	
	Mechanical data: Mounting Flush-mounted box 72 mm (bore hole 73 mm) Dimensions (visible) Diameter 110 mm, height 46 mm Protection type IP 20 (in installed state IP40)	

Motion detector

	Type	Part No.
	gesis KNX M MSD gesis KNX M MPU	F0.000.0034.8 F0.000.0034.9
<p>Motion detector for ceiling mounting with integrated bus coupling and mixed light measurement with a round detection range (360°). With a brightness-dependent output for controlling light groups, and a presence output for HLK control.</p>	Electrical data: Infeed KNX TP1 Bus coupling Integrated Detection range Horizontal 360° Mixed light measurement 30 Lux - 3000 lx Detection range of a person walking across Mounting height 3.5 m: Diameter 8 m (MSD), 24 m (MPU) Mounting height 2.5 m: Diameter 7 m (MSD), 23 m (MPU) Detection range of a person walking to the front Mounting height 3.0 m: Diameter 4 m (MSD), 8 m (MPU) Mounting height 2.5 m: Diameter 3 m (MSD), 7 m (MPU) Ambient temperature -15 °C ... +50 °C	
	Mechanical data: Mounting MSD: in ceiling cutout with 62 - 70 mm diameter MPU: on flush-mounted box 72 mm (bore hole 73 mm) Dimensions (visible) MSD: Diameter 74 mm, height 23 mm MPU: Diameter 110 mm, height 46 mm Protection type IP 20 (in installed state IP40)	

Push-button interface, 2-fold

 <p>The 2-fold push-button interface is a binary input/output device. It can be installed together with conventional push-buttons/switches in in-wall outlet boxes. This way all switching programs can be integrated into KNX systems. The inputs can be configured as outputs for LEDs.</p>	Type	Part No.
	gesis KNX TA 2/2	83.020.1404.0
Electrical data:		
Infeed	KNX TP1	
Inputs	2 for potential-free contacts	
Scanning voltage	3.3V / 0.5 mA	
Outputs	2 when configured as LED	
Output current	low current 1mA (LED 1 mA types)	
Operating temperature	-5°C to +45°C	
Mechanical data:		
Installation	in in-wall outlet box	
Cable length	25cm, extendable to max. 5m	
Dimensions	37 x 37 x 10mm	

Push-button interface, 4-fold

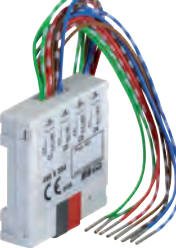
 <p>The 4-fold push-button interface is a binary input/output device. It can be installed together with conventional push-buttons/switches in in-wall outlet boxes. This way all switching programs can be integrated into KNX systems. The inputs can be configured as outputs for LEDs.</p>	Type	Part No.
	gesis KNX TA 4/4	83.020.1405.0
Electrical data:		
Infeed	KNX TP1	
Inputs	4 for potential-free contacts	
Scanning voltage	3.3V / 0.5 mA	
Outputs	4 when configured as LED	
Output current	low current 1 mA (LED 1 mA types)	
Operating temperature	-5°C to +45°C	
Mechanical data:		
Installation	in in-wall outlet box	
Cable length	25cm, extendable to max. 5m	
Dimensions	37 x 37 x 10mm	

Push-button interface, 6-fold

 <p>The 6-fold push-button interface is a binary input/output device. It can be installed together with conventional push-buttons/switches in in-wall outlet boxes. This way all switching programs can be integrated into KNX systems. Four of the six inputs can be configured as outputs for LEDs.</p>	Type	Part No.
	gesis KNX TA 6/4	83.020.1406.0
Electrical data:		
Infeed	KNX TP1	
Inputs	6 for potential-free contacts	
Scanning voltage	3.3V / 0.5 mA	
Outputs	4 when configured as LED	
Output current	low current 1 mA (LED 1 mA types)	
Operating temperature	-5°C to +45°C	
Mechanical data:		
Installation	in in-wall outlet box	
Cable length	25cm, extendable to max. 5m	
Dimensions	37 x 37 x 10mm	

KNX DALI gateway

 <p>The KNX DALI gateway N 141 is a KNX device with a DALI output for up to 64 DALI actuators (e.g. electronic ballasts with DALI interface). DALI sensors are not allowed to be connected to the output. All gateway functions are parameterized through the ETS.</p>	Type	Part No.
	DALI Gateway N141	F0.000.0017.3
Electrical data:		
Infeed – bus/main power supply	KNX TP1 / 110 – 240V AC/DC max. 7W	
Bus connection	Terminal block and data rail	
Output - DALI	approx. 16V max. 64 DALI EBs	
Mechanical data:		
Installation	DIN rail mount device for TS35	
Width	4 MW (72 mm)	

Room thermostat

 <p>Room thermostats with integrated KNX bus coupling unit for control and regulation of valve controls and heating actuators. Three integrated inputs can be used for conventional switches/push-buttons or even for external temperature sensors (optional), window contacts or presence signals.</p>	Type	Part No.
	gesis KNX RTR SP	F0.000.0032.0
<p>Electrical data:</p> <p>Infeed KNX TP1 Bus coupling unit integrated Setting range 10°C to 28°C Measuring range 0°C to 40°C</p> <p>Mechanical data:</p> <p>Installation In in-wall outlet box 55 mm or surface mount Dimensions 80 x 84 mm with a height of 27 mm Degree of protection IP20</p>		

Constant valve control

 <p>This motor-driven KNX valve control with two binary inputs and valve stroke indicator can be mounted to customary valves using an adapter (supplied). A fully automatic valve stroke detection dynamically adapts the contact path to the valve used.</p>	Type	Part No.
	gesis KNX TH S	F0.000.0032.1
<p>Electrical data:</p> <p>Infeed KNX TP1 Valve stroke detection Fully automatic Operating temperature 0°C to 50°C</p> <p>Mechanical data:</p> <p>Connection cable approx. 1 m Valve stroke max. 7.5 mm; <20s/mm; 120 N Applicable valves Danfoss RA, Heimeier, MNG, Schlösser from 3/93, Honeywess Braukmann, Dumser (distribution units), Reich (distribution units), Landis & Gyr, Oventropp, Herb, Onda Degree of protection IP21 Dimensions 82 x 50 x 65 mm</p>		

Fan coil room thermostat

 <p>This room thermostat with integrated bus coupling unit is used to control fan coil systems. It integrates a manual button for selection of the operating modes Off and Auto as well as the fan position. The three available binary inputs can be configured freely.</p>	Type	Part No.
	gesis KNX RTR FC	F0.000.0032.7
<p>Electrical data:</p> <p>Infeed KNX TP1 Bus coupling unit integrated Setting range 10°C to 28°C Measuring range 0°C to 40°C</p> <p>Mechanical data:</p> <p>Installation In in-wall outlet box 55 mm or surface mount Dimensions 80 x 84 mm with a height of 27 mm Degree of protection IP20</p>		

Fan coil output 1 – 3 levels

 <p>The fan coil actuator for DIN rail mounting with integrated bus coupling unit is used to control fan coil devices with heating/cooling circuits and 3-level fans. Furthermore this actuator has two potential-free inputs that can be used for condensate monitoring or for window contacts.</p>	Type	Part No.
	gesis KNX FC 1-3	F0.000.0032.8
<p>Electrical data:</p> <p>Infeed – bus/main power supply KNX TP1 / 230V Outputs – valves 24 – 230V AC 0.5A Outputs – fans 230V AC 8A Inputs potential-free</p> <p>Mechanical data:</p> <p>Installation DIN rail mount device for TS35 Width 4 MW (72 mm) Degree of protection IP20</p>		

Valve control, 2-level control, 230V

 <p>The electrothermal 2-level valve control for 230V can be mounted to customary valves simply by using a valve adapter. Valve adapters are not included.</p>	Type	Part No.
	gesis TH P230 Electrical data: Operating voltage Operating power Starting current Mechanical data: Connection cable Pluggable with gesis Closing/opening times Valve stroke Adapter Degree of protection Dimensions	F0.000.0032.3 230 V AC 50/60 Hz 1.8 W 300 mA for max. 200 ms, 250 mA for max. 2 min approx. 1 m we recommend gesis MINI (GST15i2) pre-assembly on request approx. 2.5 min (valve is closed without applying any power) 4 mm; 100 N; order separately IP54 60 x 44 x 61 mm

Valve control, 2-level control, 24V

 <p>The electrothermal 2-level valve control for 24V can be mounted to customary valves simply by using a valve adapter. Valve adapters are not included.</p>	Type	Part No.
	gesis TH P24 Electrical data: Infeed Operating power Starting current Mechanical data: Connection cable Pluggable with gesis Closing/opening times Valve stroke Adapter Degree of protection Dimensions	F0.000.0032.6 24 V 0 – 60 Hz 1.8 W 300 mA for max. 200 ms, 250 mA for max. 2 min approx. 1 m we recommend gesis MINI (GST15i2) pre-assembly on request approx. 2.5 min (valve is closed without applying any power) 4 mm; 100 N; order separately IP54 60 x 44 x 61 mm

Valve adapter ring VA78

 <p>Valve adapter ring VA 78 for easy installation of the valve controls. The adapter ring is placed on the valve, and the valve control is snapped on.</p>	Type	Part No.
	gesis TH VA78 Mechanical data: Applicable valves	F0.000.0032.4 Danfoss RA

Valve adapter ring VA80

 <p>Valve adapter ring VA 80 for easy installation of the valve controls. The adapter ring is placed on the valve, and the valve control is snapped on.</p>	Type	Part No.
	gesis TH VA80 Mechanical data: Applicable valves	F0.000.0032.5 Onda, Schlösser built after 1992, Oventrop M30 x 1.5, Heimeier, Herb, Therm-Concept, Frank, Roth (distribution units), Dinotherm (distribution units)

Power supply unit KNX 160 mA



Power supply unit for KNX TP1 networks with integrated choke and a rated current of 160 mA. The DIN rail mount device for distribution unit installation supplies KNX devices on shorter lines. The voltage is tapped off a terminal block at the front of the housing.

Type	Part No.
gesis KNX PS160	83.020.1413.0
Electrical data:	
Infeed	120 to 230 V AC
Output voltage	29 V DC SELV
Output current	160 mA
Bus connection	terminal block
Choke	integrated
Mechanical data:	
Installation	DIN rail mount device for TS35
Width	4 MW (72 mm)

Power supply unit KNX 320 mA



Power supply unit for KNX TP1 networks with integrated choke and a rated current of 320 mA. The DIN rail mount device for distribution unit installation supplies KNX devices on standard lines. The voltage is tapped off a terminal block at the front of the housing.

Type	Part No.
gesis KNX PS320	83.020.1414.0
Electrical data:	
Infeed	120 to 230 V AC
Output voltage	29 V DC SELV
Output current	320 mA
Bus connection	terminal block
Choke	integrated
Mechanical data:	
Installation	DIN rail mount device for TS35
Width	4 MW (72 mm)

Power supply unit KNX 640 mA



Power supply unit for KNX TP1 networks with integrated choke and a rated current of 640 mA. The DIN rail mount device for distribution unit installation supplies KNX devices of a standard line and includes an output for the unchoked voltage through a second terminal block at the front of the housing. The unchoked voltage is tapped off a terminal block at the front of the housing.

Type	Part No.
gesis KNX PS640	83.020.1415.0
Electrical data:	
Infeed	120 to 230 V AC
Output voltage	29 V DC SELV
Output current	640 mA
Bus connection	terminal block
Choke	integrated
Unchoked voltage	on terminal block
Mechanical data:	
Installation	DIN rail mount device for TS35
Width	4 MW (72 mm)

USB interface



Only 1 MW

The interface is used to create a bidirectional connection between a PC and the KNX installation bus. The USB connection is electrically isolated from the KNX bus. The interface is compatible with the ETS (Engineering Tool Software), from ETS3 and higher, and is also supported by various visualization programs.

Type	Part No.
gesis KNX USB	83.020.1418.1
Electrical data:	
Infeed KNX	through the line
Bus connection KNX	terminal block
Infeed USB	via PC
Connection USB	USB socket type B, max. 5 m
Mechanical data:	
Installation	DIN rail mount device for TS35
Width	1 MW (36 mm)

Line/backbone coupler

 <p>The line/backbone coupler is used to couple lines and backbones; it can be used as a line amplifier, too. Both the primary and the secondary lines are connected via terminal blocks.</p>	<table border="1"> <thead> <tr> <th>Type</th> <th>Part No.</th> </tr> </thead> <tbody> <tr> <td>gesis KNX LK</td> <td>83.020.1416.0</td> </tr> </tbody> </table>	Type	Part No.	gesis KNX LK	83.020.1416.0
	Type	Part No.			
gesis KNX LK	83.020.1416.0				
<p>Electrical data: Primary line DC 24 (for device supply) Secondary line DC 24V</p> <p>Mechanical data: Installation DIN rail mount device for TS35 Width 2 MW (36 mm)</p>					

IP router

 <p>The KNX IP router enables telegram routing between various lines through a LAN (IP) used as a fast backbone. This way the device replaces the KNX line coupling unit. In parallel, the KNX IP router can be used as an interface for bus access via IP. The IP address can be assigned via a DHCP server or through manual configuration (ETS).</p>	<table border="1"> <thead> <tr> <th>Type</th> <th>Part No.</th> </tr> </thead> <tbody> <tr> <td>gesis KNX IP-R</td> <td>83.020.1417.0</td> </tr> </tbody> </table>	Type	Part No.	gesis KNX IP-R	83.020.1417.0
	Type	Part No.			
gesis KNX IP-R	83.020.1417.0				
<p>Electrical data: Infeed 12 – 24V AC or 12 – 30V DC alternatively Power-over-Ethernet Power consumption < 800 mW Connection – infeed screw terminals Bus connection terminal block Ethernet connection LAN socket RJ45</p> <p>Mechanical data: Installation DIN rail mount device for TS35 Width 2 MW (36 mm)</p>					

Surge arrester KNX TP

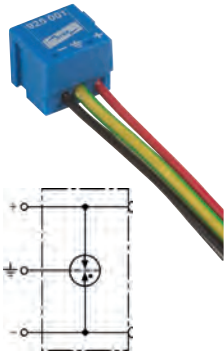
 <p>The type 2 arrester with KNX certification for KNX-TP systems has been tested according to EN 61643-21. It can directly replace the terminal block on KNX devices. The 200 mm earthing conductor is connected directly to the device.</p>	<table border="1"> <thead> <tr> <th>Type</th> <th>Part No.</th> </tr> </thead> <tbody> <tr> <td>gesis KNX OVP</td> <td>F0.000.0008.3</td> </tr> </tbody> </table>	Type	Part No.	gesis KNX OVP	F0.000.0008.3
	Type	Part No.			
gesis KNX OVP	F0.000.0008.3				
<p>Electrical data: Arrester class type 2 Rated/continuous voltage 24V/45V (for KNX TP) KNX connection spring contact (as terminal, directly pluggable to KNX device) cables Ø 0.8 mm/200 mm long cables 0.75 mm²/200 mm long</p> <p>Ground connection</p> <p>Mechanical data: Arrester in mm 12 x 11 x 11 Cables length approx. 200 mm</p>					

KNX connection module

 <p>The KNX connection module enables a simple tap of the KNX TP1 network in distribution units. The system integrator can access the network with the connection module, without removing field covers and therefore without interfering with the electrical installation.</p>	<table border="1"> <thead> <tr> <th>Type</th> <th>Part No.</th> </tr> </thead> <tbody> <tr> <td>gesis KNX REG AM</td> <td>F0.000.0033.8</td> </tr> </tbody> </table>	Type	Part No.	gesis KNX REG AM	F0.000.0033.8
	Type	Part No.			
gesis KNX REG AM	F0.000.0033.8				
<p>Electrical data: KNX Twisted Pair (SELV) Nominal current 3A Connection type terminal block (under distributor cover) pluggable to outside (BST 14i2)</p> <p>Mechanical data: Installation on TH35 e.g. in distributors Width 2 pitch units (36 mm)</p> <p>Accessories: Connectors BST 14i2 e.g. 93.422.0553.1</p>					



European Court of Justice in Luxembourg

The building was equipped with a decentralized, pluggable electrical installation by Wieland. **gesis**[®] EIB RM integrated in a **gesis**[®] RAN was used. The distribution unit variants were reduced to a minimum.

The following devices are used:

- **gesis**[®] EIB RM base module for managing the extension modules
- **gesis**[®] EIB RM sunblind modules 230V AC and 24V DC for sunblind and shade control
- **gesis**[®] EIB RM switching application for lighting control
- Cable assemblies and connectors



gesis[®] RM

KNX-Modular devices for flexible and decentralized installation

The **gesis**[®] RM module series enables highly flexible, high-performance and error-free decentralized installations with clearly reduced consumption of switching, sensor and end device cabling.

A maximum of four extension modules can be connected to a base module. The base module and extension module communicate through a flat cable and form one physical address or node. As the module series controls lighting, sunblinds, heating/ventilation/air conditioning devices and provides both radio technology and binary inputs, various requirements can be fulfilled with coherent concepts.

gesis[®] RM integrated by Wieland or the customer in a distributor to be installed decentrally, e.g. **gesis**[®] RAN from Wieland. Since they are defined for each project, dimensions and installations are almost freely selectable.

The connector type and quantity can be determined as required thanks to the use of **gesis**[®] RAN. Any configurations which may become necessary for the electrical installation system can be integrated quickly and easily, made possible by the convenient knockouts.

■ Optimal commissioning

Easy assembly and pluggability of all electrical connections allow for fast installation without the need for tools. The entire module can be programmed and tested in the room in advance. This creates clear interfaces between system integration and installation and saves a lot of time and cost at the site.



Benefits of the **gesis**[®] RM device series

- **Modular device arrangement – One physical address for various functions**
- **Low installation height of < 55 mm**
- **Optimized for decentralized room automation**
- **Pluggability with **gesis**[®] CON
Simple, error-free installation**
- **Installation in **gesis**[®] RAN to any specification – suitable for any requirement**

Common data of the gesis®RM device series

Dimensions (length/width/height in mm)

Width in the direction of the DIN rail (MW) 49mm (2.7 MW)

Height 100mm

Depth incl. mounting rail TS 35x7.5 52mm

Degree of protection IP00

Due to degree of protection IP00 the devices must be installed inside a **gesis**® distribution box or a similar housing.

Housing halogen-free

Housing color black

Installation type on TS 35 mounting rail

Software The extension modules are managed exclusively in the base module

KNX Product database for ETS available at www.wieland-electric.com

		KNX base module 83.020.0400.0	Power supply unit 1-fold 83.020.0401.0	Power supply unit 2-fold 83.020.0421.0	Binary input 8-fold 83.020.0402.0	Radio input 16-fold 83.020.0408.0	Switching output 4-fold 83.020.0403.0	Sunblind output 2-fold 230V 83.020.0404.0	Sunblind output 2-fold 24V DC 83.020.0407.0	Switching/dimming output, 2-fold 83.020.0405.0	Universal dimmer 2-fold 83.020.0409.0	DALI output 2-fold 83.020.0410.0	Semiconductor output 4-fold wide range 83.020.0406.0	Semiconductor output AC 83.020.0411.0	Semiconductor output DC 83.020.0412.0
Functions	Management of x extension modules (slots on the base module)	4													
	Supply for x base modules		1	2											
	x slots occupied				1	2	1	1	1	1	1	1	1	1	1
	Binary inputs				8										
	Radio inputs					2 x 8									
	Switching outputs, 16A (relay)						4								
	Sunblind outputs 230V 5A							2							
	Sunblind outputs 24V DC 5A								2						
	Switching/dimming output 230V / 1 – 10V									2					
	Universal dimmer 2 x 250V A RLC load										2				
	DALI output broadcast 2 x 8 EBs											2			
	Semiconductor output 24 – 230V AC/DC 0.5A												4		
	Semiconductor output 230V AC 0.5A													4	
Semiconductor output 24V DC 0.5A														4	
Voltage/ supply	Auxiliary voltage / supply 230V														
	Auxiliary voltage 12V RM power supply														
Screw terminals	0.14 – 1.5 mm² solid (inputs)														
	0.14 – 1.0 mm² solid (inputs)														
	0.14 – 4.0 mm² solid														
	0.14 – 2.5 mm² fine stranded														
Antenna connection	SMA socket														



Office with heating/cooling system with gesis[®] EIB RM

Requirements for each office

- two switched lighting circuits
- one sunblind
- one heating valve (24 V, 2-point control)
- one cooling valve (24 V, 2-point control)
- window position detection
- push-buttons and room temperature controllers with direct bus capability
- separate incoming supply for lighting and sunblinds

1 x sunblind output 2-fold	gesisRM-0/2W SI
1 x semiconductor switching output 4-fold heating/cooling valves	gesisRM-4HL
1 x binary input 8-fold window contacts	gesisRM-8/0 (12)

Installation of the modules inside a customized gesis[®]RAN.

Note

The binary input still has six available input contacts. These can be used, for example, for conventional push-buttons to control the sunblinds directly at the window.

Realization

Two offices are controlled with one gesis[®]RAN distribution unit equipped with the following modules:

- 1 x base module KNX gesisEIB RM2-BAS
- 1 x switching application 4-fold lighting gesisRM-0/4

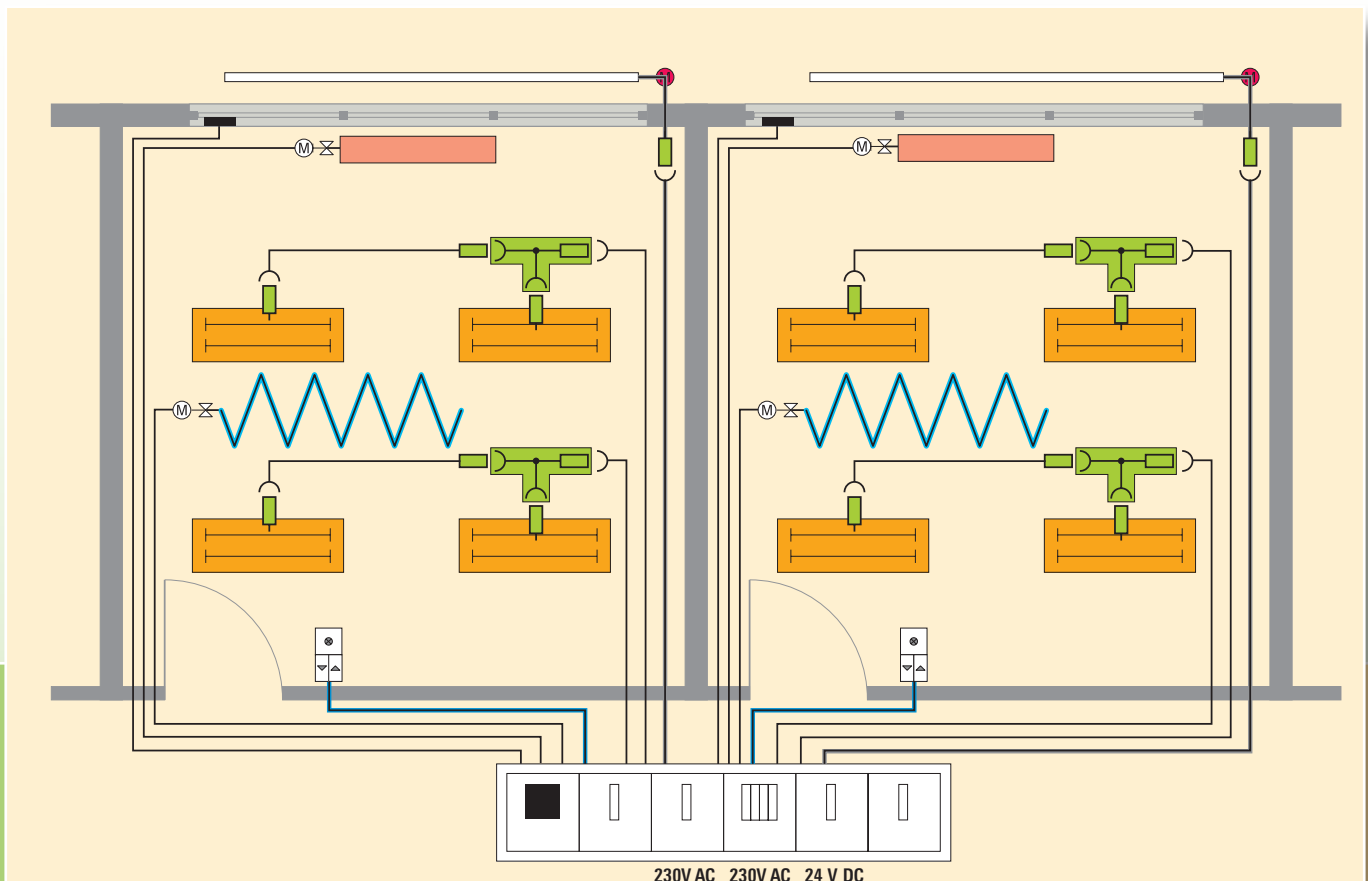

KNX RM base module



The KNX RM base module manages up to four extension modules. The extension modules are connected with a flat cable to the base module; the flat cable is supplied with the extension modules. Regardless of the number of extension modules, the module counts as one physical address.

Type	Part No.
gesis EIB RM2-BAS	83.020.0400.3
Infeed: Supply Bus	12V DC from gesis RM-PS KNX TP 1
Outputs:	four slots for flat cables to the extension modules
Accessories:	gesis RM-PS

Power supply unit for one base module



One base module can be connected to the power supply unit. The power supply unit supplies the base module and, through it, the connected extension modules, too.

Type	Part No.
gesis RM-PS	83.020.0401.0
Infeed: Supply	230 V AC
Output:	12.5 V DC SELV / 160 mA for one base module

Power supply unit for 2 base modules



Two base modules can be connected to the power supply unit. The base module and, through it, also the extension modules are supplied with energy.

Type	Part No.
gesis RM-PS 12/5	83.020.0421.0
Infeed: Supply	230 V AC
Output:	12.5 V DC SELV / 400 mA for two base modules

Extension module binary input 8-fold



Eight independent potential-free contacts can be connected to the binary input. The scanning voltage of 12 V DC is provided by the module.

Type	Part No.
gesis RM-8/0 (12)	83.020.0402.0
Infeed:	
Supply	230 V AC
Base module	pluggable flat cable on the front panel
Inputs:	
Quantity	8, for potential-free contacts max. cable length 100 m each
Scanning voltage	12 V DC SELV, provided by the module
Accessories:	RM base module

Extension module radio input EnOcean 2 x 8-fold



The radio input can manage 2 groups of eight inputs each. One slot per group is required on the base module. The radio sensors (e.g. push-buttons) are assigned directly on the module without any additional software (EnOcean learn mode).

Type	Part No.
gesis RM-16/0 (RC)	83.020.0408.0
Infeed:	
Base module	pluggable flat cable on the front panel
Inputs:	2 x 8, EnOcean sensors a total of 170 EnOcean telegrams can be programmed for the 16 inputs
Accessories:	RM base module antenna with SMA plug; we recommend the Wieland antenna 83.020.0503.0

Antenna for EnOcean devices with external antenna



The 868.6 MHz antenna is suitable for connection to Wieland **gesis** devices with a SMA socket. The black antenna can be fastened with a magnetic foot and has a 2.5m connection cable.

Type	Part No.
Antenna	83.020.0503.0
Antenna	
– 868.3MHz antenna	
– fastened with magnetic foot	
– incl. approx. 2.5m connection cable and SMA plug	

Extension module binary output 4-fold



The 4-fold switching output has four independently controllable relays. Strict isolation of the relay outputs enables connection of various phase conductors.

Type	Part No.
gesis RM-0/4	83.020.0403.0
Infeed:	
Supply	switching voltage for the outputs
from the base module	pluggable flat cable on the front panel
Outputs:	4, potential-free contacts 230 V; 16 A ohmic load
Accessories:	RM base module

Extension module 2-fold sunblind output



The 2-fold sunblind output for 230V motors with two directions of rotation can directly position the sunblind and the slat angle for each of the two outputs separately. Fusing of the outputs inside the module considerably facilitates troubleshooting in the case of a short circuit inside the sunblind circuit.

Type	Part No.
gesis RM-0/2W SI	83.020.0404.0
Infeed: Supply from the base module	230V AC (switching voltage for outputs) pluggable flat cable on the front panel
Outputs: Quantity	2, for potential-free change-over contacts with neutral center position
Fuse	230V / 5 AT integrated in the device for the two outputs together
Accessories:	RM base module

Extension module sunblind output 2-fold for 24V DC drives



The 2-fold sunblind output for 24V DC motors with two directions of rotation (pole reversion) can optionally position the two outputs separately. Fusing of the outputs inside the module considerably facilitates troubleshooting in the case of a short circuit inside the sunblind circuit.

Type	Part No.
gesis RM-0/2W DC	83.020.0407.0
Infeed: Supply from the base module	24V DC (switching voltage for outputs) pluggable flat cable on the front panel
Outputs: Quantity	2, potential-free with pole reversion
Fuse	5 AT integrated in the device for both outputs together
Rated voltage	6 – 24V DC
Accessories:	RM base module

Extension module 2-fold switching/dimming output



The switching/dimming actuator has two isolated outputs with one switching and one control output each. Strict isolation of the outputs enables connection of various phase conductors.

Type	Part No.
gesis RM-0/2SD	83.020.0405.0
Infeed: Supply from the base module	230V AC for supply of the electronic 230V AC (Switching voltage for outputs) Pluggable flat cable on the front panel
Outputs: Main power supply Control output	2 potential-free contacts for 230V; 16A 1 – 10V, max. 50mA (passive)
Accessories:	RM base module

Extension module 2-fold universal dimmer



The universal dimmer has two isolated outputs. Both outputs can automatically be adapted to the dimming behavior of the connected load (R, L, C). Mixed loads per output are not possible.

Type	Part No.
gesis RM-0/2D	83.020.0409.0
Infeed: Supply from the base module	230V AC (main supply voltage to be dimmed) pluggable flat cable on the front panel
Outputs:	2 0 – 230V AC, max. 250V A each R, L, C load (self-recognition)
Accessories:	RM base module

Extension module 2 x 8-fold DALI actuator



The DALI output has two isolated output circuits. These are used as a master and control the maximum of 8 connected electronic ballasts via broadcast commands. Error feedback is possible for each output.

Type	Part No.
gesis RM-0/2DA	83.020.0410.0
Infeed:	230V AC
Supply	pluggable flat cable on the front panel
from the base module	2, DALI as master
Outputs:	max. 8 DALI EBs each (16mA)
	commands as broadcast
Accessories:	RM base module

Extension module 4-fold semiconductor output universal



The semiconductor output is used to control four isolated circuits, for example, for electrothermal valves. As it is capable of switching 24V to 230V AC or DC, it is ideally suited to avoiding planning mistakes.

Type	Part No.
gesis RM-0/4 (HL)	83.020.0406.0
Infeed:	switching voltage for the outputs
Supply	pluggable flat cable on the front panel
from the base module	4, semiconductor outputs
Outputs:	230V AC or 24V DC, max. 0.5A per output
Accessories:	RM base module

Extension module 4-fold semiconductor output AC



The semiconductor output is used to control four isolated circuits, for example, for electrothermal valves. The switching voltage is 230V AC.

Type	Part No.
gesis RM-0/4 HL AC	83.020.0411.0
Infeed:	switching voltage for the outputs
Supply	pluggable flat cable on the front panel
from the base module	4, semiconductor outputs
Outputs:	12 – 230V AC, max. 0.5A per output
Accessories:	RM base module

Extension module 4-fold semiconductor output DC



The semiconductor output is used to control four isolated circuits, for example, for electrothermal valves. The switching voltage is 24V DC.

Type	Part No.
gesis RM-0/4 HL DC	83.020.0412.0
Infeed:	switching voltage for the outputs
Supply	pluggable flat cable on the front panel
from the base module	4, semiconductor outputst
Outputs:	24V DC, max. 0.5A per output
Accessories:	RM base module



Schwabenhof in Heilbronn

This building with its extraordinary architecture was designed by the Arbeitsgemeinschaft Riemer Planung and Lucie Holzigel and serves the headquarters for the Heilbronn-based plumbing company Roland Hertner. The **gesis® EIB M2** modular system controls the sun protection. The sunblinds are controlled by conventional push-buttons that have been integrated in KNX via binary inputs.

The following devices are used:

- **gesis® EIB M2** base module for managing the extension modules
- **gesis® EIB M2** binary inputs for integration of window contacts
- **gesis® EIB M2** sunblind actuators for controlling the shutters
- Cable assemblies and connectors



gesis® EIB M2

KNX-Modular devices for clear and sustainable installation

		Discontinuation					
		gesis EIB M2 base module 83.020.1020.0	Binary input, 4-fold 230V AC 83.020.1021.0	Binary input, 4-fold 24V DC 83.020.1022.0	Power switch, 2-fold 83.020.1023.0	Sunblind output, 2-fold 83.020.1024.0	Switching/dimming output, 1-fold 83.020.1026.0
Functions	Management of x gesis EIB M2 extension modules	6					
	Inputs 230V AC		4				
	Inputs 24V DC			4			
	Power switch 230V, no short-circuit protection						
	Parallel sunblind outputs					2	
	Switching/dimming output 230V / 1 – 10V						1
	Phase selection with jumper				X	X	X
	Firmly assigned phase conductor	L2	L3	L1			
Connector/connection*)	Main supply input						
	Bus input	5-pole GST 18i5 black					
		Automatic contacting by daisy-chaining					
	Input	2-pole BST 14i2 green					
		Internal bus, automatic contacting					
		4-pole GST 18i4 gray					
	Output	5-pole GST 18i5 light blue					
3-pole GST 18i3 black							
4-pole GST 18i4 black							
5-pole GST 18i5 pastel blue							

*) See the product range of the pluggable electrical installation system gesis®CON

This product series has found a worthy successor:

The product series **gesis® EIB M2** is being phased out in 2015. The successor series, **gesis® FLEX**, will offer even more potentials. It is likewise completely pluggable, the software functions have been significantly upgraded and the shape of the housing has been adapted to the changed structural conditions.

You will find the products of the **gesis® FLEX** series on pages 8 – 25.



Benefits of the gesis® EIB M2 device series

- Decentralized installation without additional housing
- Easy installation via snap-on connection to DIN rail
- Quick and error-free installation with pluggable connections
- Optimized devices for use in building with standard office axes
- Interoperability with certified KNX devices

Base module of the device series (discontinuation 2015)

 <p>The gesis EIB M2 base module manages up to six extension modules from the gesis EIB M2 module series. The extension modules are automatically supplied with the internal bus and the power supply voltage when daisy-chained. Regardless of the number of extension modules, the module counts as one physical address.</p>	<table border="1"> <thead> <tr> <th>Type</th> <th>Part No.</th> </tr> </thead> <tbody> <tr> <td>gesis EIB M2-BAS</td> <td>83.020.1020.0</td> </tr> </tbody> </table>	Type	Part No.	gesis EIB M2-BAS	83.020.1020.0
	Type	Part No.			
gesis EIB M2-BAS	83.020.1020.0				
<p>Infeed: Main power supply</p> <p>Bus</p> <p>Output:</p>	<p>230/400V~, 50..60Hz, max. 16A</p> <p>KNX</p> <p>internal bus for max. 6 extension modules</p> <p>230/400V main supply connection for the extension modules</p>				

Extension module 4-fold input 230V AC (discontinuation 2015)

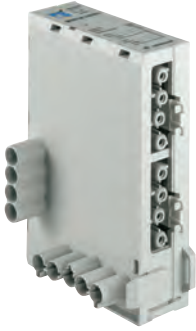
 <p>The 230V binary input can manage four independent potential-free contacts. The scanning voltage of 230V AC is provided by the module.</p>	<table border="1"> <thead> <tr> <th>Type</th> <th>Part No.</th> </tr> </thead> <tbody> <tr> <td>gesis EIB M2-4/0</td> <td>83.020.1021.0</td> </tr> </tbody> </table>	Type	Part No.	gesis EIB M2-4/0	83.020.1021.0
	Type	Part No.			
gesis EIB M2-4/0	83.020.1021.0				
<p>Infeed:</p> <p>Input data: Quantity</p> <p>Rated voltage</p> <p>Cable length</p> <p>Accessories: Base module</p>	<p>via an upstream base or extension module</p> <p>4</p> <p>230V AC, coming from the module</p> <p>max. 100m</p> <p>83.020.1020.0</p>				

Extension module 4-fold input 24V DC (discontinuation 2015)

 <p>The 24V DC binary input can manage four independent potential-free contacts. The scanning voltage of 24V DC SELV is provided by the module.</p>	<table border="1"> <thead> <tr> <th>Type</th> <th>Part No.</th> </tr> </thead> <tbody> <tr> <td>gesis EIB M2-4/0 (24)</td> <td>83.020.1022.0</td> </tr> </tbody> </table>	Type	Part No.	gesis EIB M2-4/0 (24)	83.020.1022.0
	Type	Part No.			
gesis EIB M2-4/0 (24)	83.020.1022.0				
<p>Infeed:</p> <p>Input data: Quantity</p> <p>Rated voltage</p> <p>Cable length</p> <p>Accessories: Base module</p>	<p>via an upstream base or extension module</p> <p>4</p> <p>24V DC, coming from the module</p> <p>max. 100m</p> <p>83.020.1020.0</p>				

Extension module 2-fold power switch (discontinuation 2015)

 <p>The 2-fold switching output for high loads has two independently controllable relays. For these relays together the phase conductor used can be defined through a jumper.</p>	<table border="1"> <thead> <tr> <th>Type</th> <th>Part No.</th> </tr> </thead> <tbody> <tr> <td>gesis EIB M2-0/2</td> <td>83.020.1023.0</td> </tr> </tbody> </table>	Type	Part No.	gesis EIB M2-0/2	83.020.1023.0
	Type	Part No.			
gesis EIB M2-0/2	83.020.1023.0				
<p>Infeed:</p> <p>Input data: Quantity</p> <p>Rated voltage</p> <p>Switching current</p> <p>Accessories: Base module</p>	<p>via an upstream base or extension module</p> <p>2</p> <p>230V AC</p> <p>max. 16A ohmic load, high switching capacity</p> <p>83.020.1020.0</p>				

Extension module 1 x 2-fold sunblind output (discontinuation 2015)



The sunblind output 1 x 2-fold for 230V DC motors with two directions of rotation has two uncoupled outputs that are controlled in parallel. The phase conductor used can be defined using a jumper.

Type	Part No.
gesis EIB M2-0/1Wx2	83.020.1024.0
Infeed:	via an upstream base or extension module
Output data:	
Quantity	2 parallel uncoupled
Rated voltage	230V AC
Switching current	8A ohmic load
Accessories:	
Base module	83.020.1020.0

Extension module switching/dimming output (discontinuation 2015)



The switching/dimming output has a switching and a control output for dynamic EBs with a 1 – 10V interface. The phase conductor used can be defined using a jumper.

Type	Part No.
gesis EIB M2-0/SD	83.020.1026.0
Infeed:	via an upstream base or extension module
Output data:	
Quantity	1
Main power supply	230V AC; 16A ohmic load
Switching output	1 – 10V (passive); max. 50 mA
Accessories:	
Base module	83.020.1020.0



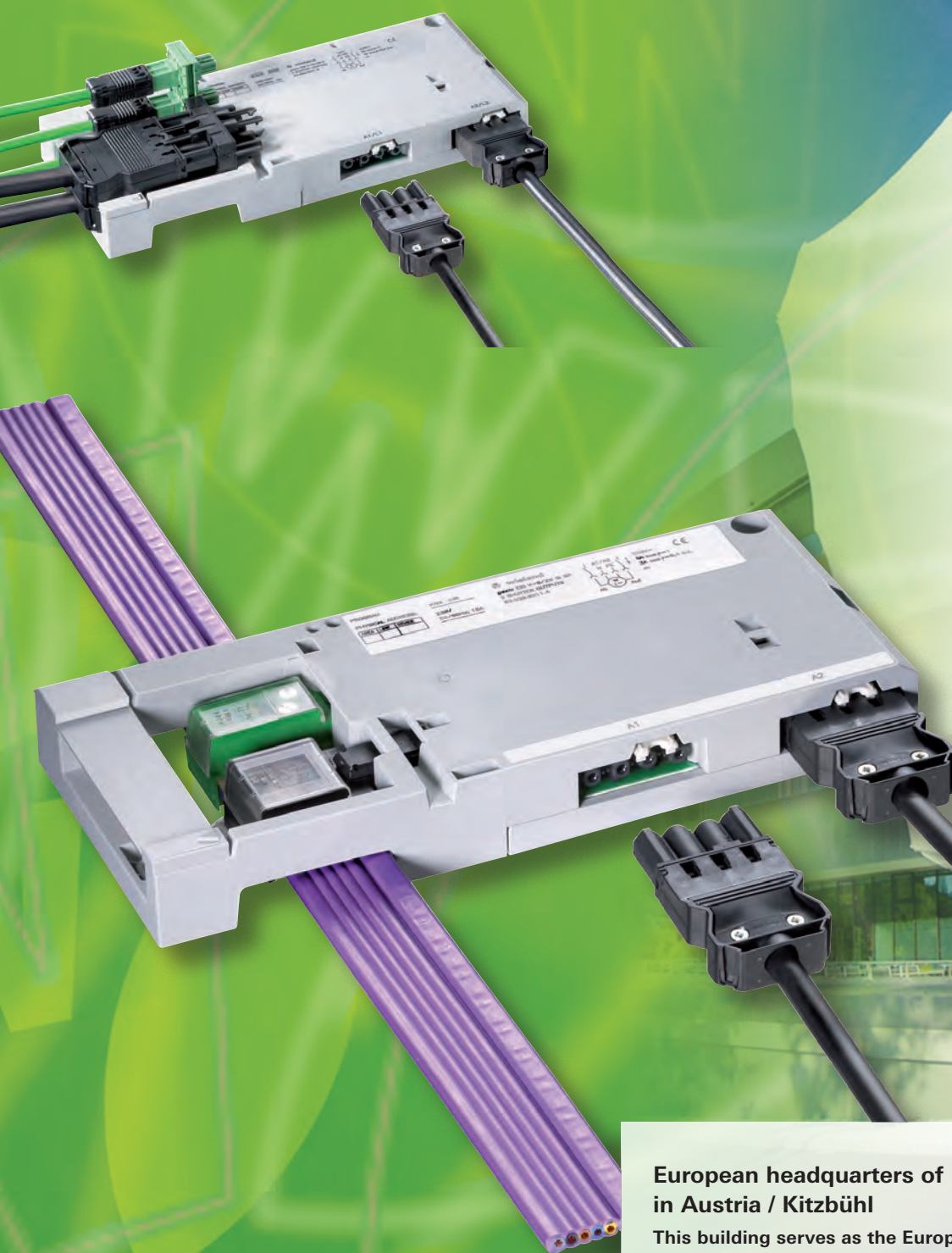

European headquarters of Eurotours in Austria / Kitzbühl

This building serves as the European company headquartes of Eurotours. The **gesis** system was used, as it ensures the flexibility required for the use of the buildings as well as quick and safe installation. **gesis**[®] EIBV actuators control lighting and sunblinds. They are supplied by a halogen-free flat cable and were placed in the double floor.

The following devices are used:

- **gesis**[®] EIBV switching outputs for lighting control
- **gesis**[®] EIBV sunblind outputs for sunblind control
- Halogen-free flat cable 5+2-pole taking over the power and KNX supply.



gesis[®] EIB V KNX device series – flat and flat conductor-compliant.

■ General

The **gesis**[®] EIB V device series can be used without additional housing and features an extremely low profile. The device is decentralized and installed near the load. Devices with the same number of inputs/ outputs differ regarding the input for main power supply. Two different versions are available: a three-phase infeed with a 5-pole connector, and a 3-pole single-phase infeed. Potential distribution of ground, N and the switched phase conductor is performed inside the modules.

■ Convenient integration of EnOcean sensors

In many systems, cabling to the sensors, e.g. push-buttons or window contacts, is not desirable or simply too complicated or not possible. EnOcean technology with its maintenance-free, batteryless sensors offers an ideal solution.

The **gesis**[®] EIB V EnOcean gateway offers the opportunity to bring EnOcean telegrams into the world of KNX. First, the gateway is parameterized with the KNX software (ETS). The sensors are assigned without software. The gateway is switched to learning mode and the desired sensor is operated. It is equally simple to delete previous assignments.

■ Installation space becomes more and more limited

Concrete core cooling, air-handling ceilings, cost-saving measures and other requirements are making the installation space in the systems increasingly smaller. With **gesis**[®] EIB V devices, you can manage almost everywhere. Due to their installation height of only 32 mm, the devices fit under cable routes, for example. They can also be inserted into a raised floor through most bottom tanks and can then be conveniently connected thanks to their pluggable connections.



Benefits of the **gesis**[®] EIB V device series

- **Decentralized installation without additional housing**
- **Flat, space-saving design**
- **Quick and error-free installation with pluggable connections**
- **Optimized devices for use in buildings with standard office axes**
- **Interoperability with certified KNX devices**

Common data of the *gesis®* EIB V device series

Dimensions	255/112/32 (71 incl. combined distribution block)
(length/width/height in mm)	
Degree of protection	IP 20
Housing	halogen-free
Housing color	light gray similar to RAL7035
Installation type	surface mount with screw fastening
Electrical connections	only pluggable
Connectors and cables	see the product range of the pluggable electrical installation system <i>gesis®</i> CON
Certification	KNX-certified
Software	Product database for ETS at www.wieland-electric.com

Range of the EnOcean gateway

The EnOcean gateway indicates with LEDs whether an EnOcean telegramme has been received and helps to determine whether the required senders reach the gateway. If one of the two gateways with external antenna are used, it can be installed in a place with better radio reception, if required. Please observe the information in the chapter on *gesis®* RC for range planning.

		Discontinuation													
		83.020.0212.0	83.020.0212.4	83.020.0213.0	83.020.0213.4	83.020.0214.0	83.020.0220.0	83.020.0220.1	83.020.0220.2	83.020.0220.3	83.020.0221.0	83.020.0221.4	83.020.0222.4	83.020.0225.0	83.020.0225.4
Functions	Switching output	1	1			6	4	4	4	4				4	4
	Sunblind output	2	2								2	2	2		
	Internal fuse 5 AT														
	Switching/dimming output			2	2										
	Radio input						56	56	56	56					
Connector/connection*)	Main supply input	Three-phase, 5-pole (GST 18i5 black)													
		Single-phase, 3-pole (GST 18i3 black)													
	KNX input	2-pole BST green													
		2-pole BST green spaced													
		3-pole GST 18i3 black													
	Output	4-pole GST 18i4 black													
		5-pole GST 18i5 black													
5-pole GST 18i5 pastel blue															
Antenna connection	SMA socket														

*) See the product range of the pluggable electrical installation system *gesis* CON

The discontinued products have found a worthy successor:

The EnOcean/KNX gateways in the *gesis®* EIB V housing are being phased out in 2015. The successor devices in the *gesis®* FLEX series will offer even more potentials. The transmitting or receiving of all standardized EnOcean telegrams (EEPs) is implemented on 32 switchable channels (bi-directional). In addition to the pure gateway functions, logic and control functions are possible.

You will find the products of the *gesis®* FLEX series on pages 8 – 25.



Room installation

Requirements for each office

Implementation

The office systems are installed throughout using a 7-pole flat cable (main power supply and bus) for the window side and a 2-pole flat cable on the door side. The combined actuator is adapted directly on the 5+2-pole flat cable and the push-button interfaces are connected to the 2-pole flat cable using a connection cable.

Alternatively, preassembled round cables and distribution blocks can be used for main power and bus supply.

Connection components used

Automation devices used

- 2 x combined actuators gesis EIB V-0/2+1W
- 2 x KNX push-button interfaces, 4-fold gesis KNX TA 4/4

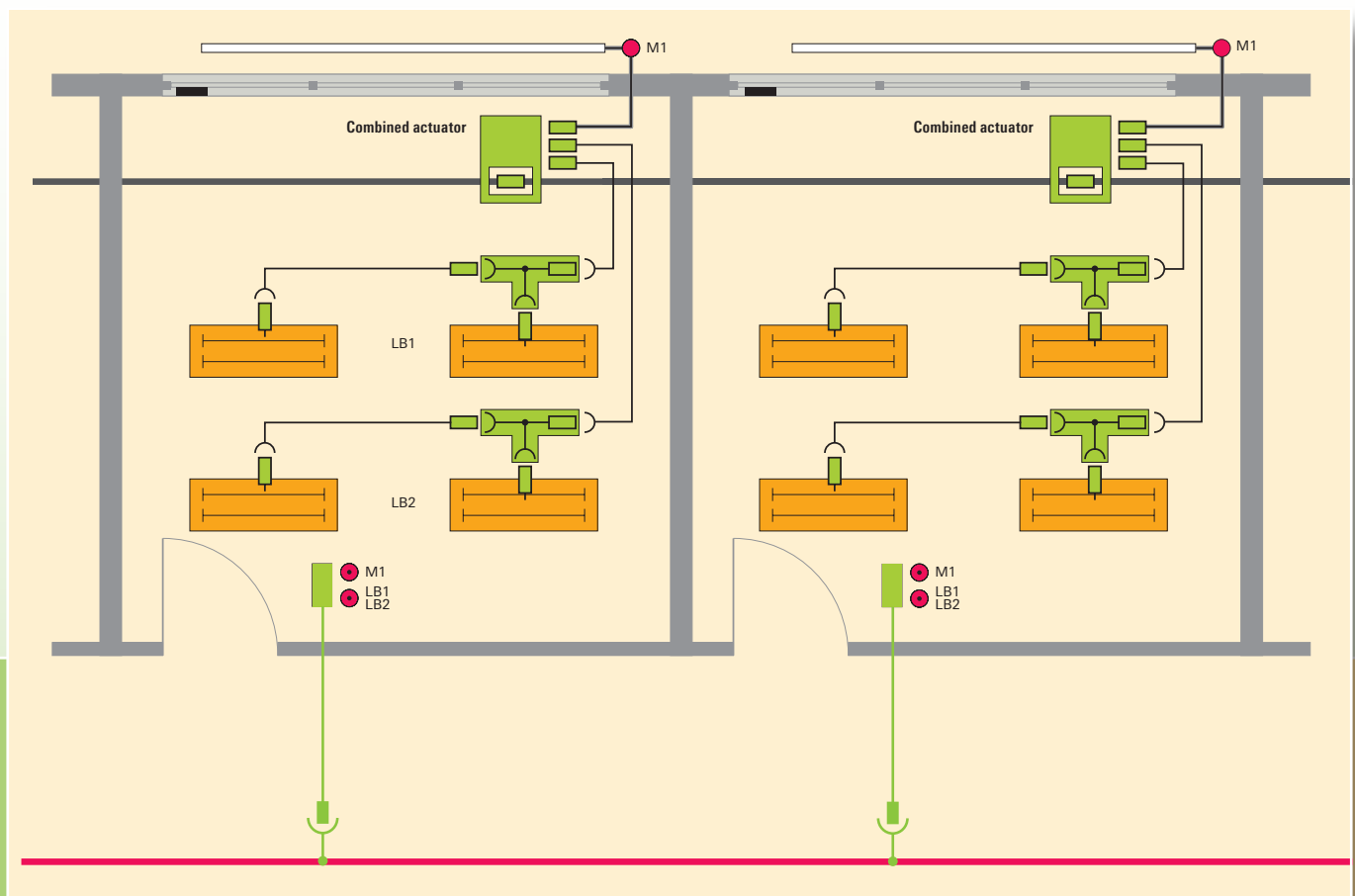

2-fold sunblind output for complex sunblind controls

	Type	Part No.
	gesis EIB V-0/2W B Three-phase main supply connection	83.020.0221.0 (output A1 → L1; A2 → L2)
	gesis EIB V-0/2W B SP Single-phase main supply connection	83.020.0221.4 (3-pole)
	gesis EIB V-0/2W F SP Single-phase main supply connection Internal fuse 5 AT	83.020.0222.4 (3-pole) 5 AT for both outputs together
<p>The KNX sunblind output for surface-mount switches two independent sunblind motors. The outputs can be positioned directly. All electrical connections are pluggable.</p>		
<p>Infeed: Supply/KNX 230/400V~, 50..60Hz, max. 16A; KNX</p> <p>Outputs: Rated voltage 230 V AC Switching current max. 16A ohmic load</p>		

4-fold switching output with increased functionality

	Type	Part No.
	gesis EIB V-0/4 B Three-phase main supply connection	83.020.0225.0
	gesis EIB V-0/4 B SP Single-phase main supply connection	83.020.0225.4 (3-pole)
<p>The 4-fold KNX switching output for surface mount has four independent switched outputs. All electrical connections are pluggable.</p>		
<p>Infeed: Supply/KNX 230/400V~, 50..60Hz, max. 16A; KNX</p> <p>Outputs: Rated voltage 230 V AC Switching current max. 16A ohmic load</p>		

6-fold switching output

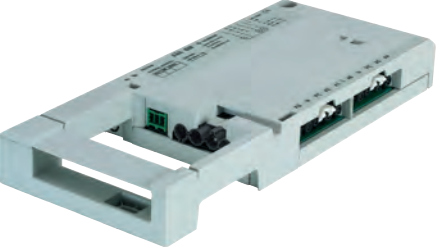
	Type	Part No.
	gesis EIB V-0/6 Three-phase main supply connection	83.020.0214.0 (output A1/A4 → L1; A2/A5 → L2; A3/A6 → L3)
<p>The 6-fold KNX switching output for surface-mount has six independent switchable outputs. Three outputs each are combined in a 5-pole connector. All electrical connections are pluggable.</p>		
<p>Infeed: Supply/KNX 400V~, 50..60Hz, max. 16A per phase conductor; KNX</p> <p>Outputs: Connection combined with three outputs in a 5 pole connector (e.g. A1, A2, A3, N, ground) Rated voltage 230 V AC Switching current max. 16A ohmic load</p>		

Combined actuator with 2-fold switching and 1-fold sunblind output



The combined KNX output for surface mount has two switching outputs and one sunblind output. All electrical connections are pluggable.

Type	Part No.
gesis EIB V-0/2+1W Three-phase main supply connection	83.020.0212.0 (output A1 → L1; A2 → L2; A3 → L3)
gesis EIB V-0/2+1W SP Single-phase main supply connection	83.020.0212.4 (3-pole)
Infeed: Supply/KNX	230/400V~, 50..60Hz, max. 16A; KNX
Outputs: Rated voltage	230 V AC
Switching current-switching output A1, A2	max. 16A ohmic load
Switching current-sunblind output A3	max. 8A ohmic load

2-fold switching/dimming output



The KNX switching/dimming output for surface mount has two independent outputs for controlling dynamic electronic ballasts for lighting control. All electrical connections are pluggable.

Type	Part No.
gesis EIB V-0/2SD Three-phase main supply connection	83.020.0213.0 (output A1 → L1; A2 → L2)
gesis EIB V-0/2SD SP Single-phase main supply connection	83.020.0213.4 (3-pole)
Infeed: Supply/KNX	230/400V~, 50..60Hz, max. 16A; KNX
Outputs: Rated voltage	230 V AC
Switching current	max. 16A ohmic load
Control output	1 – 10 V / max. 50mA (passive)

EnOcean-KNX 56-fold gateway with 4 switching outputs (discontinuation 2015)



The gateway of the EnOcean radio technology to KNX manages 170 EnOcean telegrams and transfers them to 56 KNX objects. Independently from this, four switching outputs are available. All electrical connections are pluggable.

Type	Part No.
gesis EIB V-56/4 RC Three-phase main supply connection	83.020.0220.0 (output A1 → L1; A2 → L2; A3/A4 → L3)
gesis EIB V-56/4 RCSP Single-phase main supply connection	83.020.0220.1 (3-pole)
gesis EIB V-56/4 B RC 3-phase main supply/antenna connection	83.020.0220.2 (output A1 → L1; A2 → L2; A3/A4 → L3)
gesis EIB V-56/4 B RCSP Single-phase main supply/antenna connection	83.020.0220.3 (3-pole)
Infeed: Supply/KNX	230/400V~, 50..60Hz, max. 16A; KNX
Outputs: Rated voltage	230 V AC
Switching current	max. 16A ohmic load

Antenna for EnOcean devices with external antenna



The 868.6 MHz antenna is suitable for connection to Wieland gesis® devices with a SMA socket. The black antenna can be fastened with a magnetic foot and has a 2.5m connection cable.

Type	Part No.
Antenna	83.020.0503.0
Antenna	
– 868.3MHz antenna	
– fastened with magnetic foot	
– incl. approx. 2.5m connection cable and SMA plug	



"An den Brücken" in Munich

This building was awarded the platinum award, the highest LEED certification, and uses radio technology together with KNX for sunblind and lighting control.

The following devices are used:

- EnOcean push-buttons
- Gateway EnOcean - KNX sunblind control
- gesis® EIB RM DALI lighting control - sunblind control
- gesis® CON structured and pluggable cabling of lighting and sunblind drives



gesis[®] RC

EnOcean devices with radio technology.

The **gesis**[®] RC device series (RC stands for radio-controlled) uses the EnOcean radio technology as the transfer protocol. The most outstanding feature of this technology is the use of batteryless sensors (push-buttons). These generate the power required to send a radio telegram from a electromagnetic generator. They require absolutely no maintenance.

■ **gesis**[®] RC as a stand-alone system

Some devices can be operated without any building automation system. In this application, the assignments of push-buttons and outputs is made without software – simply by pushing a button at the switching application and by actuating the desired switch for operating the lighting or sunblind group.

gesis[®] enables highly flexible installations that can be easily planned, as the switches and push-buttons can be mounted anywhere and do not require any cables.

■ **gesis**[®] RC for automation

With a gateway to KNX and a radio input for the **gesis**[®] EIB RM device series, many sensors can be conveniently integrated into the world of building automation.

■ **gesis**[®] RC for outdoors

The water-proof (IP68) RST distribution unit with EnOcean integration even makes it suitable for use outdoors.



Benefits of radio technology

- **Cable-less sensors**
simple planning, simple installation
- **Sensors without batteries**
no maintenance required
- **Stand-alone system**
programming without software
- **Integration into automation**
gateway for KNX
- **Decentralized installation**
can be installed on-site
- **Pluggable connections**
smart installation with **gesis**[®] CON

Data/radio technology

Technology

Use of the EnOcean protocol

Radio frequency

868.3 MHz

Range

- Line-of-sight Typically 30m in aisles, up to 100m in halls
- Plaster board/wooden walls Typically 30m through a maximum of 5 walls
- Brick/gas-aerated concrete walls Typically 20m through a maximum of 3 walls
- Reinforced concrete walls/ceilings Typically 10m through a maximum of 1 ceiling/wall
- Considerable limitations in the range (up to the shielding of the radio signal).

All electrically conductive materials (mostly metals) between the transmitter and the receiver or near by impair the range.

Examples:

Insulating material on metal film; suspended ceilings as well as raised floors or panels made of metal or carbon fibers; lead glass or metal-plated glass; steel furniture; sensors mounted on metal, etc. Fire protection walls, stairwells, supply and elevator shafts or similar areas should be regarded as shields. Furthermore, the angle at which the radio signals hit the wall plays a major role. Depending on the angle the effective wall thickness, and thus the signal damping, changes. The signals should not hit the wall at a narrow angle, if possible. Wall niches should be avoided.

		83.020.0500.0	83.020.0500.2	83.020.0501.1	83.020.0501.2	83.020.0504.0	83.020.0505.0	83.020.0506.0	83.020.0502.0	F0.000.0009.0	83.020.0220.x	83.020.0228.0	83.020.0408.0	F0.000.0024.4	F0.000.0024.5	83.020.0503.0		
Functions	Switching output	4	4			1	4	1			4							
	Sunblind output			2	2													
	Dimming output (R, C load)																	
	Binary input								8			2x8						
	Radio input										56	32						
	Alarm input								8									
	Window position									1								
	Pushbuttons (number of buttons /function)													1	4	2/4	2/4	1
	Gateway to											KNX	KNX					
	Reception display / field intensity																	
Properties	Pluggable connections with gesis ®CON					RST	RST											
	Screw terminals																	
	External antenna																	
	Surface mounting																	
	Box mounting																	
	DIN rail mounting																	
	Frames from the Wieland product range															incl.		

*1 Discontinuation



Room installation with central commands

Requirements for each office

- two switched lighting circuits
- one sunblind
- no cabling to the sensors available

Note

If the lighting system or sunblinds are to be operated in other locations, additional switches are simply programmed for the corresponding outputs.

Realization

The switching outputs for lighting and sunblinds control two office axes each.

1 x switching output, 4-fold	gesis RC V-0/4 1PH
1 x sunblind output, 2-fold	gesis RC V-0/2 W 1PH
2 x pushbuttons 2 channels	multivendor up/down
2 x pushbuttons 4 channels	multivendor I/O

Extension of room installation

Requirements

In addition to the existing operating options the sunblinds are to travel into a wind-safe position using a central weather station. The sunblinds are closed over the weekends using a seasonal time switch in order to prevent excessive warming of the building during the summer. The lighting shall be switched off via a central switch.

Realization

An additional radio alarm transmitter is installed in a central location. Potential-free contacts from the weather station and the time switch are connected to this alarm transmitter. The channels that are to react to the control commands are programmed with the corresponding channels of the radio alarm sender. With a 2-channel switch the lighting can be switched centrally.

1 x radio alarm sender 4-fold in	gesis RAN
	gesis RC R-16/0
1 x antenna for alarm sender	gesis RC Z ANT SMA
1 x push-button, 2 channels	multivendor I/O

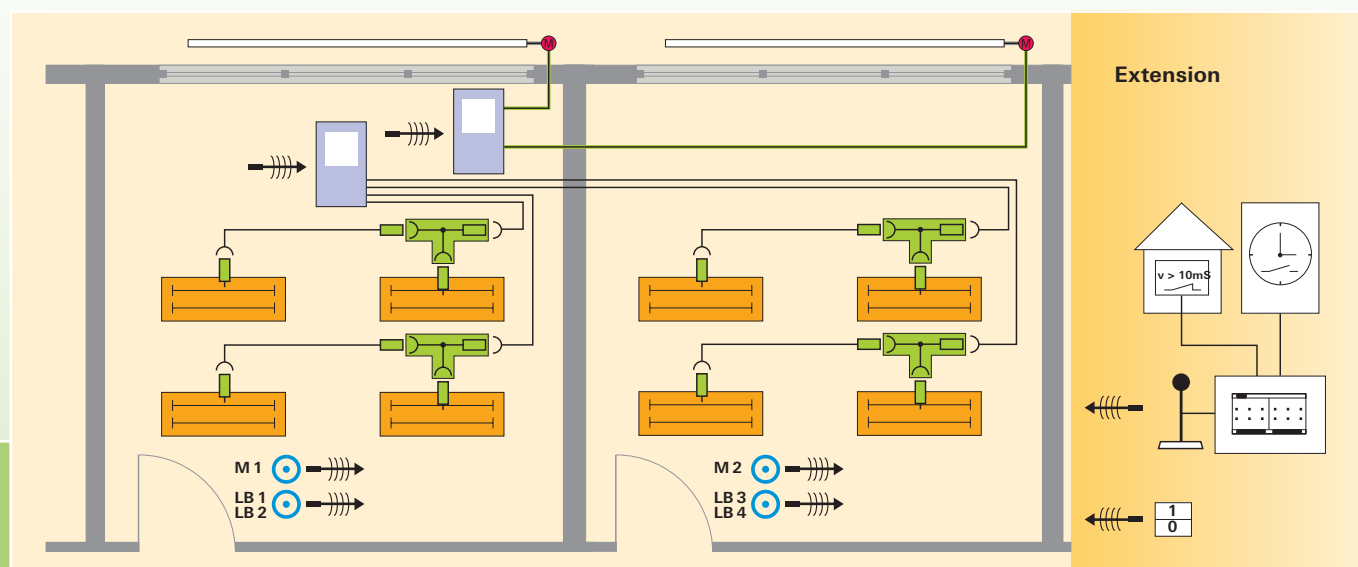

Note

As the radio signals' range is limited, it must be ensured that all outputs are within the range of the alarm transmitter. If this is not possible, in the case of central commands over several floors, for example, several alarm senders can be connected in parallel.

Switching output, 4-fold



Output module with four relay outputs for switching four independent load groups with sensors that use EnOcean radio technology.

Type		Part No.
gesis RCV-0/4 1PH	1-phase main supply	83.020.0500.0
gesis RCV-0/4 B 1PH	1-phase main supply/antenna connection	83.020.0500.2
Infeed:		
Main power supply	230 V AC	
Rated voltage	230 V AC (N, ground, switched phase conductor)	
Switching current	16 A ohmic load	
General data:		
Installation	surface mounting, fixing with screws	
Degree of protection	IP20	
Dimensions (length/width/height)	254/112/32 mm	
Connection and supply components are available in the gesis [®] con section.		

Sunblind output, 2-fold



Output module with two sunblind outputs for switching two independent sunblind motors with sensors that use EnOcean radio technology. In addition, each output has an alarm function.

Type		Part No.
gesis RCV-0/2WAL 1PH	1-phase main supply	83.020.0501.1
gesis RCV-0/2WALB 1PH	1-phase main supply/antenna connection	83.020.0501.2
Infeed:		
Main power supply	230 V AC	
Rated voltage	230 V AC, (N, ground, up, down)	
Switching current	5 A ohmic load	
General data:		
Installation	surface mounting, fixing with screws	
Degree of protection	IP20	
Dimensions (length/width/height)	254/112/32 mm	
Connection and supply components are available in the gesis [®] con section.		

Switching outputs and LED drivers for outdoors



EnOcean switching outputs in the IP68 surface housings for outdoor use feature four or one 230V relay. They can be programmed for 30 push-button pairs. All electrical connections are pluggable. Voltage and power supplies for LED and low-voltage halogen luminaires are available as accessories.



The EnOcean power supply units in the IP68 surface housings for outdoor use are designed for connecting low-voltage halogen or LED luminaires. All electrical connections are pluggable.

Type		Part No.
gesis RCRST-0/1	1 relay output, 1 feed-through wiring	83.020.0504.0
gesis RCRST-0/1x2	2 relay outputs connected in parallel	83.020.0504.1
gesis RCRST-0/4	4 relay outputs, 1 feed-through wiring	83.020.0505.0
Infeed:		
Power input/output	230 V AC / 20 A connector RST coding black	
Outputs:		
Quantity	1/4	
Connection type	connector RST coding black	
Rated voltage	230 V AC	
Switching capacity gesis RCRST-0/1...	5 A total ohmic load	
Switching capacity gesis RCRST-0/4	6 A (max. two of the LED/LV halogen modules given below)	
General data:		
Degree of protection	IP68 (all connections plugged or closed)	
Dimensions (length/width/height)		
gesis RCRST-0/1...	104/162/57 mm	
gesis RCRST-0/4	104/162/96 mm	
Mounting option	4 elongated holes	
Voltage supplies:		
gesis RSTPSU 12/12 LED	1 LED control unit 12V/12W, 1 feed-through wiring	83.020.0900.0
gesis RSTPSU 24/12 LED	1 LED control unit 24V/12W, 1 feed-through wiring	83.020.0901.0
gesis RSTPSU 12/70 LVH	1 LV halogen control 12V/70W, 1 feed-through wiring	83.020.0904.0
Power supply units:		
gesis RSTPSI 350/12 LED	1 LED control unit 350 mA/12W, 1 feed-through wiring	83.020.0902.0
gesis RSTPSI 700/12 LED	1 LED control unit 700 mA/12W, 1 feed-through wiring	83.020.0903.0

Switching output with 1 channel



Single-channel output module with screw connections. The small design enables installation in in-wall outlet boxes or surface mount.

Type	Part No.
gesis RCUP-0/1	83.020.0506.0
Infeed:	
Power input	230 V AC / 16 A screw clamp terminals
Outputs	
Quantity	1
Connection type	screw clamp terminals
Rated voltage	230 V AC
Switching capacity F0.000.0016.9	5 A ohmic load
General data:	
Installation	surface mounting, fixing with screws
Degree of protection	IP30
Dimensions (length/width/height)	48/29/35 mm

Alarm transmitter for sunblind control and binary input



This device has eight digital alarm inputs as well as eight digital standard inputs. The input signals are sent as EnOcean telegrams. The alarm inputs can cyclically send defined alarm positions, top or bottom, for sunblind outputs. Time monitoring of the alarm telegrams is performed by the sunblind outputs.

The standard inputs send defined EnOcean telegrams equivalent to the radio switches.

Type	Part No.
gesis RCR-16/0	83.020.0502.0
Infeed:	
Voltage	24 V DC ± 20%
Current	35 mA
Inputs:	
Quantity	8 x alarm inputs, 8 x binary inputs
General data:	
Installation	on DIN rail TH 35
Degree of protection	IP20
Dimensions (width)	approx. 6 MW (93 mm)
Accessories:	
Antenna	Part No. 83.020.0503.0

Window contact



Batteryless and maintenance-free window contact with integrated power buffer for night operation.

Type	Part No.
gesis RC S-SRWSENFK	F0.000.0009.0
Supply:	
Solar cells	min. brightness 100Lux (best from 400Lux)
Power reserve	min. 14 hours fully charged
General data:	
Color	signal white similar to RAL 9003
Dimensions (length/width/height)	110/19/15 mm
Contact connector	magnet 23/14/6 mm
Installation	surface

Radio input from the gesis® RM system



The radio input that has to be operated with a base module that conforms to the type of system can manage 2 groups of eight inputs each. One slot per group is required on the base module. The radio sensors (e.g. push-buttons) are assigned directly on the module without any additional software (EnOcean learning mode).

Type	Part No.
gesis RM-16/0 (RC)	83.020.0408.0
Infeed:	
Base module	pluggable flat cable on the front panel
Inputs:	
	2 x 8, EnOcean sensors
	a total of 170 EnOcean telegrams can be programmed for the 16 inputs
Accessories:	
Antenna	83.020.0503.0
KNX base module	83.020.0400.3

EnOcean Gateway

	Type	Std. Pack	Part No.
	gesis FLEX-ENO32 without plug set	10	83.020.0628.0
gesis FLEX-ENO32 Z with plug set	1	83.020.0628.1 Female and male, BST14i2 (KNX)	
Infeed Bus connection KNX EnOcean signals			
		BST14i2, green male connector in the module 32 channels, can be switched to bi-directional, all current EEPs	
Output Bus connection KNX EnOcean signals			
		BST14i2, green female connector in the module 32 channels, can be switched to bi-directional, all current EEPs	
Accessories Base and extension modules from the gesis ® FLEX serie			

EnOcean-KNX 56-fold gateway with 4 switching outputs (discontinuation 2015)

	Type	Part No.
	gesis EIB V-56/4 RC Three-phase main supply connection	83.020.0220.0 (output A1 → L1; A2 → L2; A3/A4 → L3)
gesis EIB V-56/4 RCSP Single-phase main supply connection	83.020.0220.1 (3-pole)	
gesis EIB V-56/4 B RC Three-phase main supply/antenna conn.	83.020.0220.2 (output A1 → L1; A2 → L2; A3/A4 → L3)	
gesis EIB V-56/4 B RCSP Single-phase main supply/antenna conn.	83.020.0220.3 (3-pole)	
Infeed: Main power supply/KNX		
		230/400V~, 50..60 Hz, max. 16A; KNX
Outputs: Rated voltage Switching current		
		4, can be controlled separately 230V AC max. 16A ohmic load
Accessories: Antenna		
		Part No. 83.020.0503.0

The gateway of the EnOcean radio technology to KNX manages 170 EnOcean telegrams and transfers them to 56 KNX objects. Independently from this, four switching outputs are available. All electrical connections are pluggable.

Handheld radio transmitter, 4 channels

	Type	Color	Part No.
	Handheld radio transmitter	black	F0.000.0009.2
Batteryless and maintenance-free 4-channel handheld transmitter for direct control of the actuators.			
Handheld radio transmitter – Batteryless and maintenance-free – For stick-on surface mounting or as handheld remote control			

Convenient hand-held transmitter



Included in delivery

The convenient hand-held transmitter allows for control of the complete building. Whether complex lighting concepts or comprehensive actions according to a detailed schedule: this hand-held terminal lets you program building functions in the twinkling of an eye. Menu navigation is intuitive and is supported by easily understandable symbols.

Additionally, the device offers service functions for the installer regarding range planning and can be used for function testing during commissioning.

Type	Part No.
Convenient hand-held transmitter	F0.000.0024.4
Technical data:	
Radio channels	512
Configurable levels	32
Displays	time, date, temperature
Texts and symbols	pre-defined or configurable
Lock	with PIN code
Timers	32
Speed dial keys	8
Dimensions (length/width/height)	165/55/21 mm
Special EnOcean function:	EnOcean service function, e.g. ID display, quality of radio signals, and a radio link test (enables range test between two hand-held terminals)
Power supply:	
Supply with batteries	3 AAA-NiMH power packs (included in delivery)
Charging device	USB charging device and separate USB cable (included in delivery)

Multivendor radio switch, 2/4 channels



Batteryless and maintenance-free radio switches with 2/4 channels for direct control of the actuators. The rockers in neutral center position are marked with I/O or Up/Down (▲▼) symbols. These 55x55mm switches enable installation in various designs of various manufacturers.

Type	Color	Part No.	Marking
Radio switch, 2 channels	white	F0.000.0005.6	I / O
	anthracite	F0.000.0007.5	I / O
	aluminum finish	F0.000.0007.6	I / O
Radio switch, 2 channels	white	F0.000.0005.8	(▲▼)
	anthracite	F0.000.0007.7	(▲▼)
	aluminum finish	F0.000.0007.8	(▲▼)
Radio switch, 4 channels	white	F0.000.0005.7	I / O
	anthracite	F0.000.0007.9	I / O
	aluminum finish	F0.000.0008.0	I / O
Radio switch, 4 channels	white	F0.000.0005.9	(▲▼)
	anthracite	F0.000.0008.1	(▲▼)
	aluminum finish	F0.000.0008.2	(▲▼)

- batteryless and maintenance-free
- for mounting on flat surfaces with screws or adhesive pads (included in delivery)
- the radio switches fit the following frames with 55mm installation size following vendors:
Berker: S1, B1, B3, B7 Glas
Gira: Standard 55, E2, Event, Esprit
Jung: A500, A plus
Merten: M-Smart, M-Arc, M-Plan

Multivendor radio switches with 2/4 channels (light) (I / O)
- the rockers are imprinted with I/O symbols

Multivendor radio switches with 2/4 channels (sunblind) (Up / Down) (▲▼)
- the rockers are imprinted with Up/Down (▲▼) symbols

Radio switch, 2/4 channels glossy with suitable frame



This push-button series features a glossy, smooth surface. The radio switches with 2 or 4 channels do not require batteries or maintenance. The rockers are in neutral central position and without marking with 1/0 or up/down symbols. The matching frames for these push-buttons can be found below.



Energy self-sufficient Hotel Card switch for storage and simultaneous sending of an EnOcean telegram. Together with suitable actuators from the **gesis**[®] RC device series, the power supply of the room can be operated directly or the signal can be transmitted to the building automation.



Frame for installation of the 2/4-channel glossy radio switches. Suitable for vertical and horizontal mounting.

Type	Color	Part No.	Marking
Radio switch, 2 channels	pure white	F0.000.0025.0	1 / 0
	pure white	F0.000.0025.2	(△▼)
	pure white	F0.000.0025.4	
	piano black	F0.000.0025.9	1 / 0
	piano black	F0.000.0026.1	(△▼)
	piano black	F0.000.0026.3	
	aluminum	F0.000.0026.8	1 / 0
	aluminum	F0.000.0027.0	(△▼)
Radio switch, 4 channels	aluminum	F0.000.0027.2	
	pure white	F0.000.0025.1	1 / 0
	pure white	F0.000.0025.3	(△▼)
	pure white	F0.000.0025.5	
	piano black	F0.000.0026.0	1 / 0
	piano black	F0.000.0026.2	(△▼)
	piano black	F0.000.0026.4	
	aluminum	F0.000.0026.9	1 / 0
aluminum	F0.000.0027.1	(△▼)	
aluminum	F0.000.0027.3		
<p>* 2 channels represent one rocker in neutral center position. This function is defined in the receiver.</p> <p>* 4 channels represent two rockers in neutral center position. This function is defined in the receiver.</p> <ul style="list-style-type: none"> - glossy surface - batteryless and maintenance-free - for installation on flat surfaces with screws or adhesive pads (included in delivery) - the combination frames have to be ordered separately 			
Hotel Card switch	white	F0.000.0024.6	
Hotel Card switch	piano black	F0.000.0024.7	
Hotel Card switch	aluminum	F0.000.0024.8	
Power supply:		energy is produced when the card is inserted	
Energy self-sufficient		surface, stick-on or screws	
Installation:		surface, on a standard in-wall outlet box	
Dimensions:		55 x 85 mm (standard dimensions)	
Hotel Card			
Combination frame 1-fold	pure white	F0.000.0025.6	
	pure white	F0.000.0025.7	
	pure white	F0.000.0025.8	
Combination frame 1-fold	piano black	F0.000.0026.5	
	piano black	F0.000.0026.6	
	piano black	F0.000.0026.7	
Combination frame 1-fold	aluminum	F0.000.0027.4	
	aluminum	F0.000.0027.5	
	aluminum	F0.000.0027.6	

Repeater, 2-level



This repeater receives EnOcean telegrams and sends these as they are with maximum transmitting power, either in 1 or 2-level operation. This amplifies the radio signal twice at the maximum and enhances the radio range significantly.

Type	Part No.
Repeater	F0.000.0024.5
Power supply: Rated voltage	230 V AC
Installation Installation option	in-wall outlet box or surface mount fixing clip for a standard 60mm outlet socket
Dimensions (height/width/installation depth)	48/50/35 mm

Antenna for EnOcean devices with external antenna



The 868.6 MHz antenna is suitable for connection to Wieland **gesis** devices with a SMA female connector. The black antenna can be mounted using a magnetic foot and has a 2.5m connection cable.

Type	Part No.
Antenna	83.020.0503.0
Antenna	
– 868.3MHz antenna	
– mounted with magnetic foot	
– incl. approx. 2.5m connection cable and SMA connector	

Radio switch, 2/4 channels and suitable frames (phase-out)



Batteryless and maintenance-free radio switches with 2/4 channels for direct control of the actuators. The rockers in neutral center position are marked with I/O or Up/Down (△▼) symbols. Between the rockers there is a marking field with detachable marking strips. The following combination frames fit these radio switches.



Frame for installation of the 2/4-channel radio switches for vertical or horizontal mounting.

Type	Color	Part No.	Marking
Radio switch, 2 channels	white	F0.000.0002.1	I / 0
	aluminum finish	F0.000.0004.4	I / 0
	white	F0.000.0002.2	(△▼)
Radio switch, 4 channels	aluminum finish	F0.000.0004.5	(△▼)
	white	F0.000.0002.3	I / 0
	aluminum finish	F0.000.0004.6	I / 0
	white	F0.000.0002.4	(△▼)
	aluminum finish	F0.000.0004.7	(△▼)
– batteryless and maintenance-free			
– for mounting on plane surfaces with screws or adhesive pads (included in delivery)			
Radio switch, 2/4 channels (light) I / 0			
– the rockers are imprinted with I/O symbols			
Radio switch, 2/4 channels (sunblind) Up / Down			
– the rockers are imprinted with Up/Down (△▼) symbols			
Combination frame 1-fold	white	F0.000.0002.5	
	aluminum finish	F0.000.0004.8	
Combination frame 2-fold	white	F0.000.0002.6	
	aluminum finish	F0.000.0004.9	
Combination frame 3-fold	white	F0.000.0003.5	
	aluminum finish	F0.000.0009.7	
Combination frame, 1-fold to 3-fold			
– match the radio switches			
– not suitable for multivendor radio switches			



Conventional installation versus automation

In many areas of building installation, effectiveness and comfort are demanded but building automation solutions are not employed. In such cases, presence or motion detectors are often used.

At the same time, dimmed lighting is increasingly being realized by means of DALI. The **gesis®** presence detector as a fully-fledged DALI master is the ideal solution here.

Yet overvoltage protection is also becoming more and more important. It's not only a lightning strike that can destroy electronic systems. Overvoltages can also be caused by switching operations, for instance. The overvoltage protection that can be ideally integrated into the **gesis®** installation provides protection here.



gesis[®] .

Other applications designed to be pluggable. Presence detectors, overvoltage protection and transformers.

■ Other applications for pluggable electronic systems.

Motion and presence detectors are being used for lighting control with increased regularity. Above all in offices and classrooms, and not only in corridors or adjoining rooms. Both switching detectors and dimming detectors are used. Dimming is realized almost exclusively via DALI. The reliable detection of slight motions is crucial to applications for sedentary activities. Simple detectors are not suitable for this purpose, since they have a very coarse data acquisition grid and detect only severe motions. Wieland detectors take this into account and are equipped with very sensitive detectors.

■ DALI

Digital Addressable Lighting Interface, DALI for short, is the standard in lighting control. Besides 230V, two conductors are laid for controlling electronic ballasts for fluorescent lamps, LED ballast sand other applications. These are normally laid together with the power supply lines in one conductor. DALI is a conventional master/slave system. It controls and regulates, in dependence of brightness and motion, up to 64 DALI ballasts in four separate groups.

■ Overvoltage protection

Overvoltage protection is becoming increasingly important. The financial consequences come not from defective devices such as computers, but the outage costs caused by the defect. The **gesis**[®] overvoltage protection is a Type 3 arrester which is used near to the end devices. For the protection against overvoltages caused by lightning flashes to work properly, a comprehensive lightning protection concept must be designed for the building.

■ Electronic systems made pluggable

With the advent of LED technology, devices such as the electronic transformers on the following pages are certainly no longer in such great demand even for customized lighting. Here, they are mainly symbolic for the potentials created by the **gesis**[®] plug systems. We tailor, with pleasure, electronic systems for our customers so they can be simply plugged into the electronic installations.

The benefits of pluggable electronic systems

- Easy, quick and safe to install
- No need to open the housing to connect the conductor (avoiding accessible electronic systems)
- Fast change of electronics in case of a fault
- Industrial design quality transferred to the installation

Classrooms as an example

Requirements

The lighting in classrooms has to be controlled in dependence of brightness and presence. The various elements of natural light between window side and corridor side must be noted and the light strips at various levels considered. The lighting must be activated by a fully-automated mechanism if required. The lighting levels are to be changed or switched on by force as and when necessary. In large rooms, where the range of one presence detector is inadequate, a second detector has to be used as a slave to the 1st detector.

Realization

The DALI presence detector performs this task par excellence. As the DALI master, it can control up to 64 DALI ballasts in four groups. Three of these groups can be dimmed and one group, for the blackboard lighting, can be switched. Various offsets can be specified for the three dimming groups. As a result, the window side can be dimmed more than the corridor side when there is enough

exterior light. The installation location of the sensor serves as a reference point. The lighting can be controlled manually via the remote at any time. If the sensor detection range is not adequate, another detector is quickly integrated into the pluggable installation as the slave. Just like the master sensor and the lights, it is simply integrated into the DALI line in parallel.

Used automation devices:

- 1 x DALI presence detector
- 1 x power supply GST18i5 socket in pastel blue for the local connection (in this case, only N, L and PE are connected).
- 1 x distributor with 1 E/3A GST18i5 pastel blue
- Depending on the number of lights, T-pieces GST18i5 pastel blue
- Pre-assembled conductors GST18i5, pastel blue in various lengths
- Lights with GST18i5 pastel blue connection

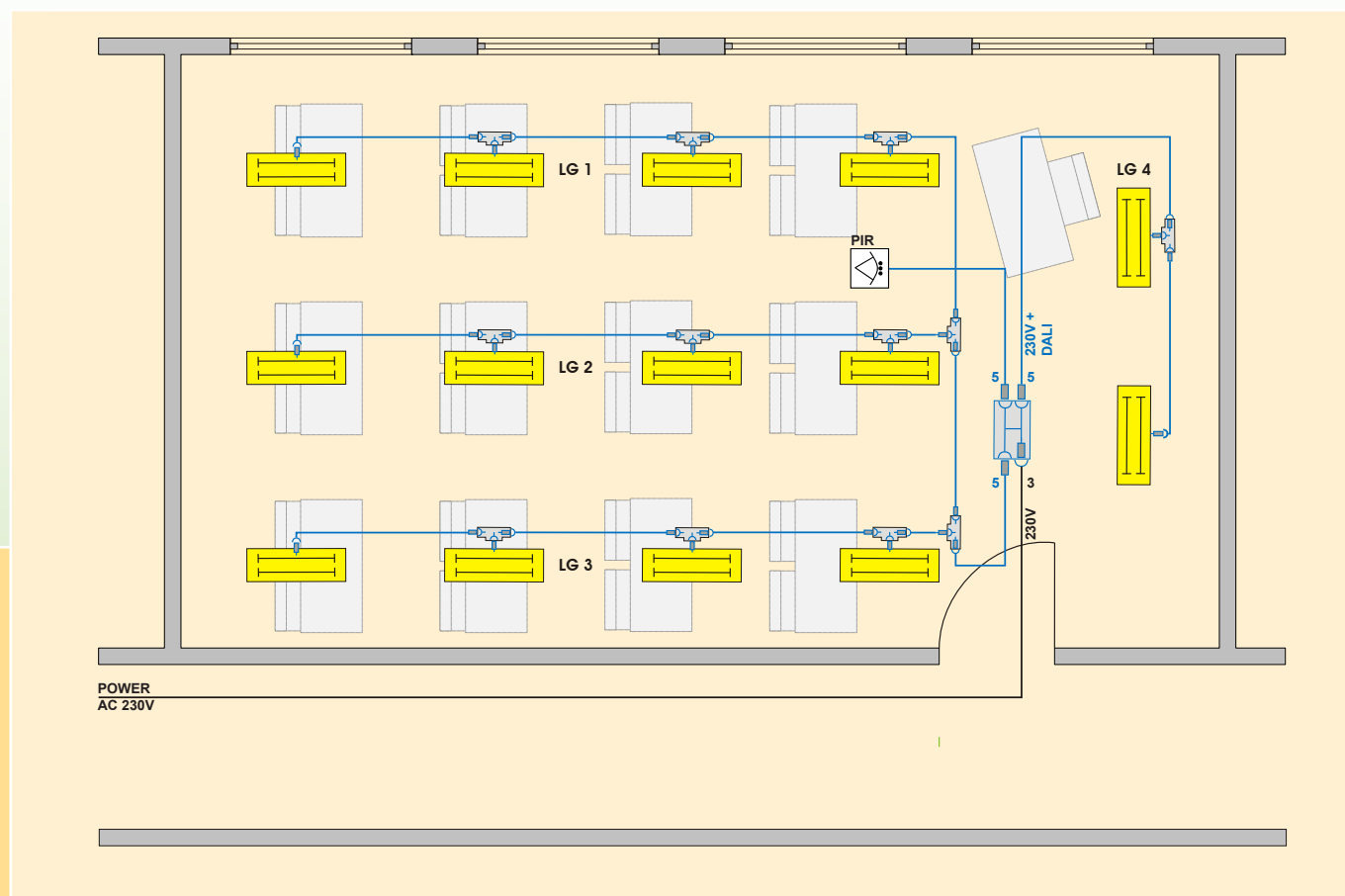

DALI presence detector



	Function	Input/output	
		Type	male GST18 Code2
P	Infeed	Only 230 V	5-pole pastel blue
MA	Master	230 V DALI	
SL	Slave		
H	DALI luminaire		

Type	Std. pack	Part no.
Master gesis P CLS-DALI-31	1	83.020.0115.1
Slave gesis P MS-DALI-SL		83.020.0116.1

Rated voltage: 230 V / 50 Hz
 Output: DALI
 64 ballasts in
 4 groups (3 x dimming, 1 x switching)

Mounting location: Ceiling
 Mounting height: 2.4 to 3.0 m
 Range: 8-12 m, round
 Plug system: GST18i5, Code 2, pastel blue
 Accessories: T-distributor 92.050.1453.0

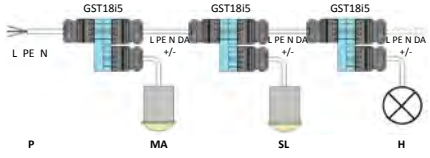

Comment:
Power supply system:
 Power is supplied to the system via a female connector, GST18i5, pastel blue, to which only L, N and PE is connected. The DALI signal is supplied from the master to the DALI installation.

Through-wiring:
 The through-wiring is completely 5-pole. All stations and detectors are connected in parallel.



Master with direct luminaire connection (MA)
 83.020.0110.1

Type	Std. pack	Part no.
Master with direct luminaire connection (MA) gesis P MS8-360-1L	1	83.020.0110.1
Master for connecting a cross connect (MAB) gesis P MS8-360-1Lb	1	83.020.0110.2
Cross connect accessories		92.030.0153.1
Master for connecting a slave (MASL) gesis P MS8-360-1LSL	1	83.020.0110.3
Slave with direct luminaire connection (SLa) gesis P MS8-360-SLb	1	83.020.0111.1
Slave with connection for further slave (SLSL) gesis P MS8-360-SLSL	1	83.020.0111.2

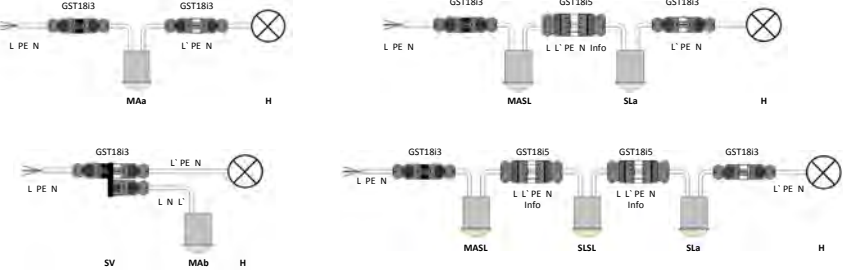

Rated voltage: 230 V / 50 Hz
 Switching current: 10 A
 Switching load: 165 A/20 ms || 800/20 ms || max. 140 µF
 Mounting location: Ceiling
 Mounting height: 2.4 to 3.0 m
 Range: 8-12 m, round
 Plug system: See table, left

	Function	Input		Output	
		Type	male GST18 Code1	Type	male GST18
MAa	Master	230 V	3-pole black	230 V	3-pole white
MAB	Master	Contained in the output			3-pole brown
MASL	Master	230 V	3-pole black	to the slave	5-pole white
SLa	Slave	from the master or slave	5-pole black	230 V	3-pole white
SLSL	Slave	from the master or slave	5-pole black	to the slave	5-pole white
SV		Cross connect			
H		Luminaire			

IR transmitter for commissioning and operating the presence and motion detector

	Type	Std. pack	Part no.
	Commissioning gesis PIR IR B-21 IPD	1	83.020.0120.0
<p>This remote control is required for setting the presence detector functions, e.g. delay times, lighting levels or the assignment of DALI groups. It can be used for any number of detectors.</p>			

IR transmitter for operation

	Type	Std. pack	Part no.
	Operation gesis PIR IR B-04 IPD	1	83.020.0120.1
<p>This remote control permits the user to operate the assigned presence or movement detectors, and hence temporarily change the dimming value, for example.</p>			

gesis[®] overvoltage protection Type 3

	Type	Std. pack	Part no.
	Optical defect indicator	1	84.990.1242.0
	Acoustic defect indicator	1	84.990.1243.0
	Connectors	GST18i3, Code 1, black Type 3 according to EN 61643-11+A11	
	Worker classification	Class 3 according to IEC 61643-1	
U _e	255 V / 50 Hz		
Max. fusing	16 A gl/gG (B 16 A)		
Ambient temperature	-25° C ... +40° C		

Electronic transformer for low-volt halogen lights



Type	Std. pack	Part no.
Assembled on primary and secondary side 1	1	99.449.9999.9
Nominal voltage	230 V 150-60 Hz	
Rated current	0.45 A (primary)	
Output		
Nominal voltage	11,8 V	
Connected load	35 ... 105 W	
Ambient temperature	max. 50° C	
Short-circuit protective device	Electronic, automatic restart	
Dimensions (transformer)	175 x 42 x 18 mm	
Connection		
Primary side	GST18i3, Code 1, white	
Secondary side	ST 16/2 BS	
Assembled on primary and secondary side, assembled pluggable	1	99.448.9999.9
Assembled on secondary side	1	99.449.9999.9

Outdoor installation



gesis® RST® – plug & play outdoors

Water-tight electronics.

■ The challenge

Expert operation plays a major role, particularly for electrical installations outdoors. Difficult installation conditions and extreme time pressure often lead to errors, loss of protection and finally to the failure of the system.

■ The solution

As a complete installation system, **gesis® RST®** is optimally adapted to these increased requirements. It is very flexible in its application and has proven technology at its disposal. Luminaires can thus be delivered in a pre-assembled design. They only have to be plugged in on-site. The connectors are also touch-safe when they have not yet been plugged in; they provide a locking device against accidental loosening.

The possibility of connecting almost all customary cable types (including underground cables) as well as the IP 68 and IP 69K protection degree make the RST® connector a strong partner for outdoor lighting.



■ Optimization

The system becomes even more versatile with **gesis® RC RST®** switching outputs with integrated EnOcean radio technology. The outputs for 230 V can switch 6 A at maximum and can be controlled with standard EnOcean key functions. Two LED drivers from the system family can be connected to each switched output. A transmission frequency of 868.3 MHz and EnOcean radio technology are used.

Benefits of the *gesis® RST®* device series

- **Quick IP68 installation with pluggable connections**
- **Safe installation as devices do not have to be opened to connect them**
- **Easy installation with pre-assembled devices and cables**
- **Easy operation due to use of EnOcean radio technology**
- **Comprehensive as LED drivers are available in the system housing**

Common data

Type of protection	IP65, IP66, IP67, IP68 (3 m; 2 h), IP69K all IP protection degrees are only valid for plugged cables or closed connections
Connector	only from the gesis® RST20i2 and gesis® RST20i3 series
Dimensions	
high housing	104/162/96 mm
flat housing	104/162/58 mm
Housing	thermoplastic PA 66 halogen-free
Housing color	black

Data/radio technology

Technology using the EnOcean protocol

Radio frequency 868.3 MHz

Range

- Line-of-sight typically 30m in corridors, up to 100m in halls
- Plaster board/wooden walls typically 30m through max. 5 walls
- Brick/gas-aerated concrete walls typically 20 m through max. 3 walls
- Reinforced concrete walls/ceilings typically 10 m through max. 1 floor/wall
- Considerable limitations in the range (up to the shielding of the radio signal)

All electrically conductive materials (mostly metals) between the transmitter and the receiver or nearby impair the range.

	Switching application EnOcean 4-fold 83.020.0905.0	Switching application EnOcean 1-fold 83.020.0904.0	Switching application EnOcean 1-fold 83.020.0904.1	LED constant voltage supply 12V 83.020.0900.0	LED constant voltage supply 24V 83.020.0901.0	LED constant voltage supply 350 mA 83.020.0902.0	LED constant voltage supply 700 mA 83.020.0903.0	Low voltage halogen transformer 83.020.0904.0
Outputs (enOcean controlled)	4	1	1					
Outputs switching in parallel			2					
230V Through-wiring	1	1		1	1	1	1	1
LED outputs 12V/12W				1				
LED outputs 24V/12W					1			
LED outputs 350 mA/12W						1		
LED outputs 700 mA/12W							1	
Low voltage halogen output 21V/20-70W								1
RST 20i3 black for power								
RST 20i2 brown for low voltage								
RST 20i2 gray for low voltage								

*1 See the product range of the pluggable electrical installation system **gesis®** CON



Garden installation with *gesis® RST®*

Requirements

Switching various spotlights in a hotel garden. The individual switching groups are to be controlled via radio as there is only one supply line. Furthermore, trained personell shall be able to easily modify the system.

Realization

All components are pluggable. The *gesis® RST®* connector system is used in order to meet the degree of protection required for electrical safety. The radio outputs are controlled with switches from indoors. To keep them in the same design as the other switches and sockets, multivendor switches and the corresponding design frames are used.

Wieland devices used

- ① 2 x push-buttons 4-channel F0.000.0002.3
- ② 1 x EnOcean switching application 4-fold 83.020.0505.0
- ③ LED constant current supply 350 mA 83.020.0902.0
- ④ LED constant current supply 350 mA 83.020.0902.0
- ⑤ Distribution block for series connection 99.910.0000.7
- ⑥ Lighting 230V with RST20i3 connection 230V
- ⑦ LED spotlight with RST20i2 connection max. 50 V

The initial connection is made to a female connector for pre-assembly on-site. The connection cables in various lengths are also pre-assembled. Connections not used are closed with covers.

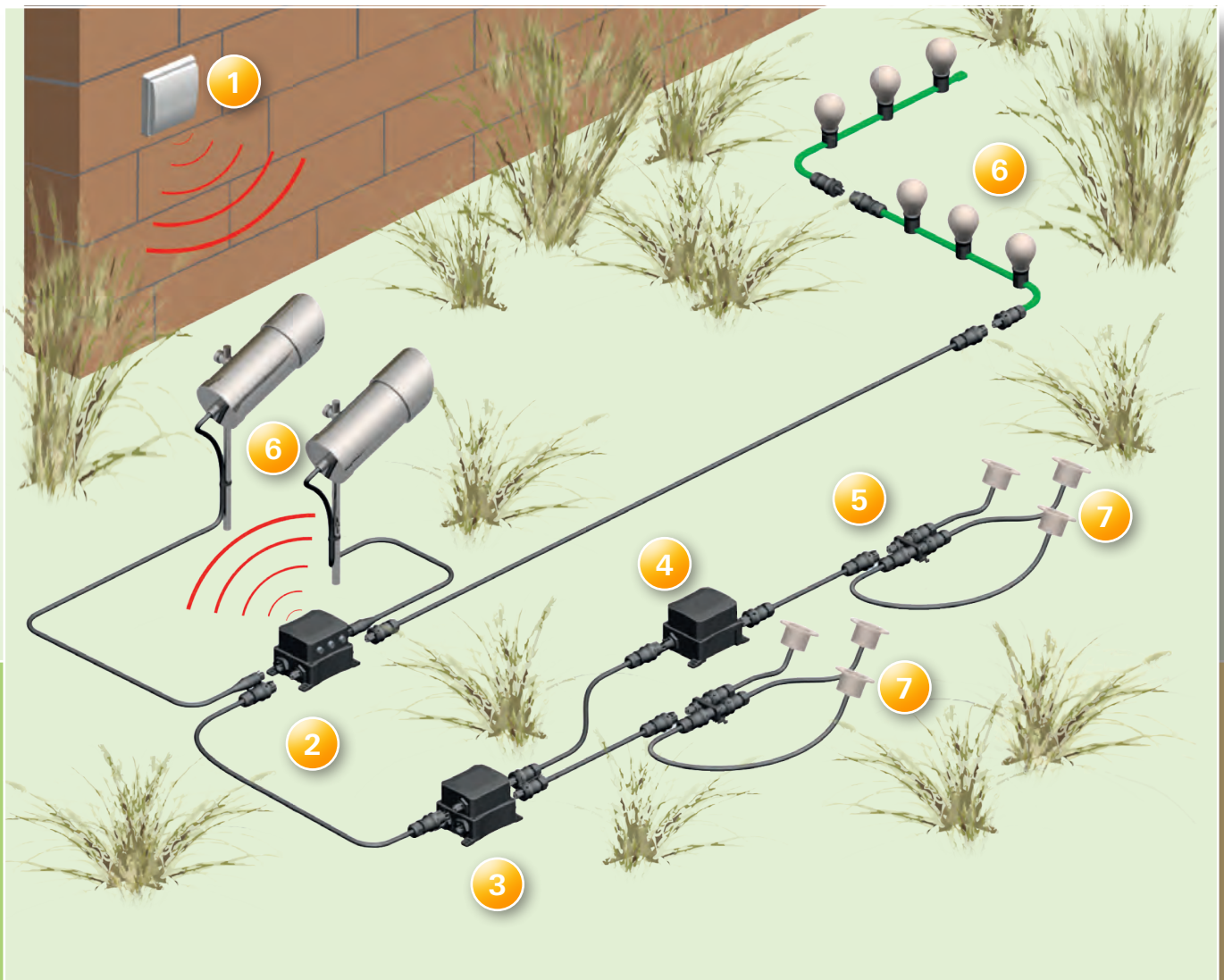

Switching application EnOcean 4-fold

 <p>EnOcean 4-fold switching outputs in the IP68 surface housings for outdoor use feature four 230V relays. They can be programmed for 30 push-button pairs. All electrical connections are pluggable.</p>	<table border="1"> <thead> <tr> <th>Type</th> <th>Part No.</th> </tr> </thead> <tbody> <tr> <td>gesis RC RST-0/4</td> <td>4 relay outputs, 1 feed-through wiring</td> <td>83.020.0505.0</td> </tr> </tbody> </table>	Type	Part No.	gesis RC RST-0/4	4 relay outputs, 1 feed-through wiring	83.020.0505.0
	Type	Part No.				
gesis RC RST-0/4	4 relay outputs, 1 feed-through wiring	83.020.0505.0				
<p>Incoming supply: Power input/output</p> <p>Outputs: Quantity Connection type Rated voltage Switching capacity</p> <p>General data: Type of protection Dimensions (length/width/height) Installation option</p>	<p>230V AC / 20A connector RST 20i3 coding black</p> <p>4 connector RST20i3 coding black 230V AC 6A (max. two of the LED/LV halogen modules given below)</p> <p>IP68 (all connections plugged or closed) 104/162/96 mm 4 elongated holes</p>					

Switching application EnOcean 4-fold

 <p>EnOcean 1-fold switching outputs in the IP68 surface housing for outdoor use feature one 230V relay. They can be programmed for 30 push-button pairs. All electrical connections are pluggable.</p>	<table border="1"> <thead> <tr> <th>Type</th> <th>Part No.</th> </tr> </thead> <tbody> <tr> <td>gesis RC RST-0/1</td> <td>1 relay output, 1 feed-through wiring</td> <td>83.020.0504.0</td> </tr> <tr> <td>gesis RC RST-0/1x2</td> <td>2 relay outputs connected in parallel</td> <td>83.020.0504.1</td> </tr> </tbody> </table>	Type	Part No.	gesis RC RST-0/1	1 relay output, 1 feed-through wiring	83.020.0504.0	gesis RC RST-0/1x2	2 relay outputs connected in parallel	83.020.0504.1
	Type	Part No.							
gesis RC RST-0/1	1 relay output, 1 feed-through wiring	83.020.0504.0							
gesis RC RST-0/1x2	2 relay outputs connected in parallel	83.020.0504.1							
<p>Incoming supply: Power input/output</p> <p>Outputs: Quantity Connection type Rated voltage Switching capacity</p> <p>General data: Type of protection Dimensions (length/width/height) Installation option</p>	<p>230V AC / 20A connector RST 20i3 coding black</p> <p>1 connector RST20i3 coding black 230V AC 5A total ohmic load</p> <p>IP68 (all connections plugged or closed) 104/162/96 mm 4 elongated holes</p>								

Constant power supply unit, 350 mA DC

 <p>Constant power supply unit 350 mA for connecting LEDs. Connections not used have to be closed.</p>	<table border="1"> <thead> <tr> <th>Type</th> <th>Part No.</th> </tr> </thead> <tbody> <tr> <td>gesis RST PSI 350/12 LED</td> <td></td> <td>83.020.0902.0</td> </tr> </tbody> </table>	Type	Part No.	gesis RST PSI 350/12 LED		83.020.0902.0
	Type	Part No.				
gesis RST PSI 350/12 LED		83.020.0902.0				
<p>Incoming supply: Input power (male connector) Output power (female connector) Output LED (female connector)</p> <p>General data: Type of protection Ambient temperature Dimensions (length/width/height) Installation option Electrical connections</p>	<p>230V AC/20A RST20i3 coding black 230V AC/20A RST20i3 coding black 350mA DC/max. 12W RST20i2 coding brown</p> <p>IP68 (all connections plugged or closed) -25°C to +55°C 104/162/96 mm 4 elongated holes pluggable with RST20i2 ... 20i3</p>					

Constant power supply unit, 700 mA DC

 <p>Constant power supply unit 700 mA for connecting LEDs. Connections not used have to be closed.</p>	<table border="1"> <thead> <tr> <th>Type</th> <th>Part No.</th> </tr> </thead> <tbody> <tr> <td>gesis RST PSI 700/12 LED</td> <td></td> <td>83.020.0903.0</td> </tr> </tbody> </table>	Type	Part No.	gesis RST PSI 700/12 LED		83.020.0903.0
	Type	Part No.				
gesis RST PSI 700/12 LED		83.020.0903.0				
<p>Incoming supply: Input Power (male connector) Output Power (female connector) Output LED (female connector)</p> <p>General data: Type of protection Ambient temperature Dimensions (length/width/height) Installation option Electrical connections</p>	<p>230V AC/20A RST20i3 coding black 230V AC/20A RST20i3 coding black 700mA DC/max. 12W RST20i2 coding brown</p> <p>IP68 (all connections plugged or closed) -25°C to +55°C 104/162/96 mm 4 elongated holes pluggable with RST20i2 ... 20i3</p>					

LED constant voltage supply, 12V DC

 <p>Constant voltage supply unit 12 V for connecting LEDs. Connections not used have to be closed.</p>	<table border="1"> <thead> <tr> <th>Type</th> <th>Part No.</th> </tr> </thead> <tbody> <tr> <td>gesis RST PSU 12/12 LED</td> <td>83.020.0900.0</td> </tr> </tbody> </table>	Type	Part No.	gesis RST PSU 12/12 LED	83.020.0900.0
	Type	Part No.			
gesis RST PSU 12/12 LED	83.020.0900.0				
<p>Incoming supply: Input power (male connector) 230 V AC/20A RST20i3 coding black Output power (female connector) 230 V AC/20A RST20i3 coding black Output LED (female connector) 12 V DC/max. 12 W RST20i2 coding pebble gray</p> <p>General data: Type of protection IP 68 (all connections plugged or closed) Ambient temperature -25 °C to +55 °C Dimensions (length/width/height) 104/162/96 mm Installation option 4 elongated holes Electrical connections pluggable with RST20i2 ... 20i3</p>					

LED constant voltage supply, 24V DC

 <p>Constant voltage supply unit 24 V for connecting LEDs. Connections not used have to be closed.</p>	<table border="1"> <thead> <tr> <th>Type</th> <th>Part No.</th> </tr> </thead> <tbody> <tr> <td>gesis RST PSU 24/12 LED</td> <td>83.020.0901.0</td> </tr> </tbody> </table>	Type	Part No.	gesis RST PSU 24/12 LED	83.020.0901.0
	Type	Part No.			
gesis RST PSU 24/12 LED	83.020.0901.0				
<p>Incoming supply: Input power (male connector) 230 V AC/20A RST20i3 coding black Output power (female connector) 230 V AC/20A RST20i3 coding black Output LED (female connector) 12 V DC/max. 12 W RST20i2 coding pebble gray</p> <p>General data: Type of protection IP 68 (all connections plugged or closed) Ambient temperature -25 °C to +55 °C Dimensions (length/width/height) 104/162/96 mm Installation option 4 elongated holes Electrical connections pluggable with RST20i2 ... 20i3</p>					

Transformer for low-voltage halogen luminaires, 12V AC

 <p>Power supply unit 12 V for connecting halogen luminaires. Connections not used have to be closed.</p>	<table border="1"> <thead> <tr> <th>Type</th> <th>Part No.</th> </tr> </thead> <tbody> <tr> <td>gesis RST PSU 12/70 LVH</td> <td>83.020.0904.0</td> </tr> </tbody> </table>	Type	Part No.	gesis RST PSU 12/70 LVH	83.020.0904.0
	Type	Part No.			
gesis RST PSU 12/70 LVH	83.020.0904.0				
<p>Incoming supply: Input power (male connector) 230 V AC/20A RST20i3 coding black Output power (female connector) 230 V AC/20A RST20i3 coding black Output LV halogen (female connector) 12 V AC/20 – 70 W RST20i2 coding pebble gray Output LV halogen cable length max. 2 m</p> <p>General data: Type of protection IP 68 (all connections plugged or closed) Ambient temperature 0 °C to +45 °C (derating from 35 °C) Dimensions (length/width/height) 104/162/96 mm Installation option 4 elongated holes Electrical connections pluggable with RST20i2 ... 20i3</p>					

Accessories: covers

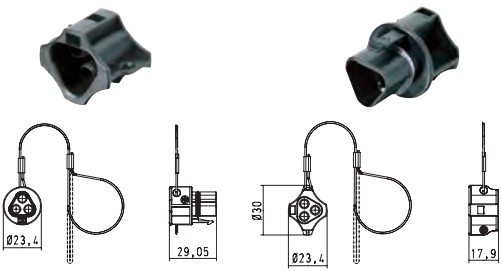
 <p>The covers have to be used to close all unused inputs and outputs. Without these covers, only IP20 is achieved!</p>	<table border="1"> <thead> <tr> <th>Type</th> <th>Part No.</th> </tr> </thead> <tbody> <tr> <td>Suitable for all RST20i2 and RST20i3 codings</td> <td></td> </tr> <tr> <td>For male connector captive against loss</td> <td>99.416.6205.2</td> </tr> <tr> <td>For male connector not captive against loss</td> <td>05.564.4453.1</td> </tr> <tr> <td>For female connector captive against loss</td> <td>99.414.6205.2</td> </tr> <tr> <td>For female connector not captive against loss</td> <td>Z5.564.4553.1</td> </tr> </tbody> </table>	Type	Part No.	Suitable for all RST20i2 and RST20i3 codings		For male connector captive against loss	99.416.6205.2	For male connector not captive against loss	05.564.4453.1	For female connector captive against loss	99.414.6205.2	For female connector not captive against loss	Z5.564.4553.1
	Type	Part No.											
Suitable for all RST20i2 and RST20i3 codings													
For male connector captive against loss	99.416.6205.2												
For male connector not captive against loss	05.564.4453.1												
For female connector captive against loss	99.414.6205.2												
For female connector not captive against loss	Z5.564.4553.1												

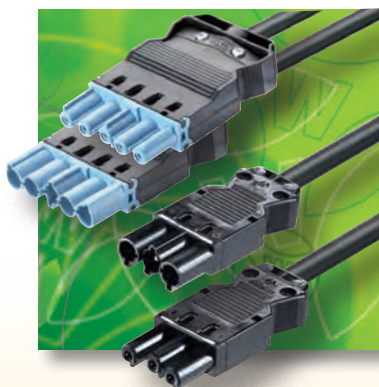

GST 18i 3-pole to 6-pole

The product range for the installation of lighting systems, switches and outlets, 3, 4, 5, or 6-pole. Mechanical coding enables a clear separation of different applications. In addition, the color of the connectors indicates the relevant links.

Features

- Proven connector system for fixed installations
- Consistent according to IEC 61535
- Pre-assembled cables save time at the construction site



GST 15, 2-pole to 5-pole

Connector for connection directly on-site. Male or female complete with strain relief for connection of all current types of cable. 2- to 5-pole with different codings.

Features

- Compact MINI connectors
- Integrated locking device
- Connection of cables up to a cross-section of 2.5 mm²
- Codings for mains voltage, low-voltage and dimmer applications
- Straight and elbow strain relief for 4 and 5-pole connectors

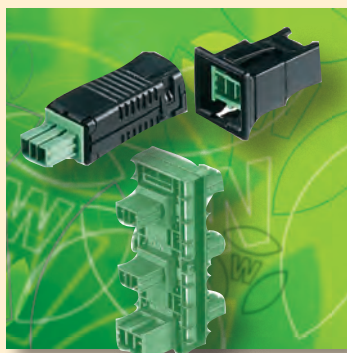

BST 14i2 and BST 14i3

BST allows the pluggable installation even of signal applications. Mechanical coding and clear assignments by different colors make installation easy: green for EIB/KNX applications, black for general signal or LON applications.

Features

- Standard connectors for KNX applications
- Distribution units and device connectors
- Pre-assembled cables

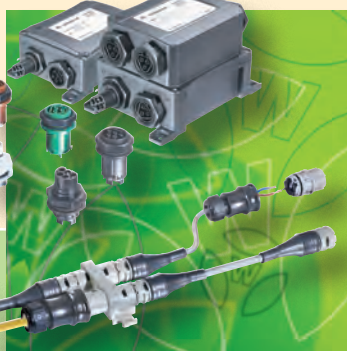

RST 20i 2-pole to 5-pole

The RST system serves as safe and durable cabling with increased degree of protection. The types of protection IP65/67, IP68 (3m; 2h) and IP69K prevent ingress of e.g. water, dust, oil and soot. The RST system features various codings that are not plug-compatible with each other. This is ideal to keep different applications separate, ensuring correct polarity.

Features

- Quick, safe and easy installation
- Increased degree of protection (IP65/67, IP68 (3m; 2h) and IP69K)
- Comprehensive distribution unit and accessories program
- Pre-assembled cables save time at the construction site



More detailed product information:
0670.1 **gesis**®
Pluggable electrical installation
for indoors

Available directly from our download center
on the Internet in PDF format;
product information also in e-CAT at
<http://eshop.wieland-electric.com>

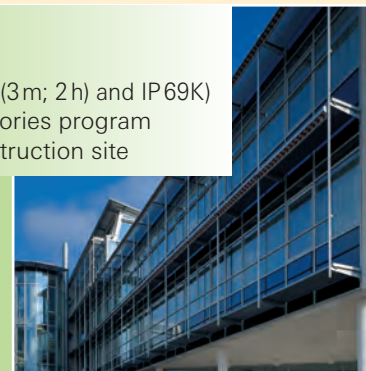



gesis[®] CON – facility management – simply plug it in. Perfect building installation.

gesis[®] – one name, one idea, an unparalleled success story! With pluggable electrical installation, Wieland has been the unchallenged market leader for 30 years. No wonder since time savings of 70 % and cost reductions of 30 % always speak for themselves.

The benefits of the plug-and-play principle are apparent everywhere: no more cutting to length, stripping and threading into terminals: **gesis**[®] system components are industrially pre-assembled and tested. Everything fits perfectly, and only needs to be plugged together on-site. **gesis**[®] is the standard for safe and error-free installation.

The **gesis**[®] system comprises connectors, radio-controlled switching units, devices for decentralized building automation and pluggable distribution boxes for state-of-the-art facility management, cables, and busbar and low-voltage systems.

gesis[®] CON is the ingenious principle for building installation technology – in high-rise buildings just as in family homes, and from the basement to the roof. The unique variety of more than 5,000 components offers solutions for any kind of electrical installation.

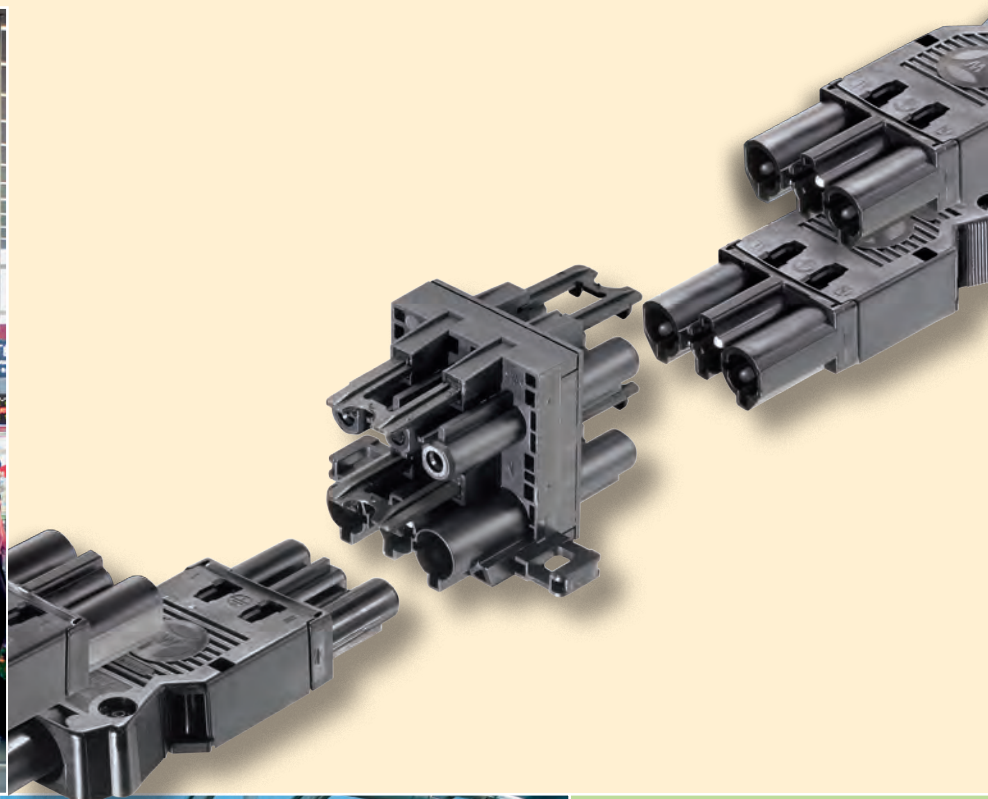

Connector system in IP20 format for Outputs

GST 18i3, coding 1, black		GST 18i4, coding 1, black		GST 15i2, coding 3, light blue		GST 18i5, coding 1, black	
Length m	Part No.	Length m	Part No.	Length m	Part No.	Length m	Part No.
Use for switching outputs (relay) 230V AC		Use for sunblind outputs 230V AC		Use for sunblind outputs 24V AC		Use for switching outputs (relay) 230V AC, 5-pole	
gesis EIB V		gesis EIB V		gesis EIB RM		gesis EIB V	
Combination actuator	83.020.0212.x	Sunblind output	83.020.0221.x	Sunblind output	83.020.0407.0	Switching output	83.020.0214.x
Gateway	83.020.0220.x	Sunblind output	83.020.0222.4	gesis FLEX			
Switching output	83.020.0225.x	Combination actuator	83.020.0212.x	Sunblind output	83.020.0607.0		
gesis RC		gesis RC					
Switching output	83.020.0500.x	Sunblind output	83.020.0501.x				
gesis FLEX		gesis FLEX					
Switching output	83.020.0623.x	Sunblind output	83.020.0624.x				
Switching output C-load	83.020.0626.0	gesis EIB M2					
gesis EIB M2		Sunblind output	83.020.1024.x				
Switching output	83.020.1023.x						
Male, screw connection		Male, screw connection		Male, screw connection		Male, screw connection	
							
Test plug	92.932.3053.1 92.002.5153.1	Test plug	92.944.3053.1 92.002.5253.1	Test plug	91.922.3353.0		92.954.4053.1
Male – free end 3 x 1.5 H05VV-F (PVC)		Male – free end 4 x 1.5 H05VV-F (PVC)		Male – free end 2 x 1.5 H04VV-F (PVC)		Male – free end 5 x 1.5 H05VV-F (PVC)	
							
1.0 to	92.232.1004.1	1.0 to	92.207.1004.1	1.0 to	91.222.1004.6	1.0 to	92.257.1004.1
8.0 to	92.232.8004.1	8.0 to	92.207.8004.1	8.0 to	91.222.8004.6	8.0 to	92.257.8004.1
Male – female 3 x 1.5 H05VV-F (PVC)		Male – female 4 x 1.5 H05VV-F (PVC)		Male – female 2 x 1.5 H04VV-F (PVC)		Male – female 5 x 1.5 H05VV-F (PVC)	
							
1.0 to	92.232.1000.1	1.0 to	92.207.1000.1	1.0 to	92.222.1000.6	1.0 to	92.257.1000.1
8.0 to	92.232.8000.1	8.0 to	92.207.8000.1	8.0 to	92.222.8000.6	8.0 to	92.257.8000.1

Connector system in IP 20 format for Outputs / Inputs

GST 15i2, coding 2, light blue		GST 18i5, coding 2, pastel blue		GST 15i5, coding 3, light blue		GST 18i5, coding 3, light blue	
Length m	Part No.	Length m	Part No.	Length m	Part No.	Length m	Part No.
Use for DALI outputs		Use for switching/dimming outputs		Use for binary input 24V DC		Use for binary input 24V	
gesis EIB RM DALI aktor 83.020.0410.0		gesis EIB V Switching/dimming output 83.020.0213.x		gesis FLEX Input 83.020.0622.0		gesis EIB M2 Input 24V 83.020.0214.x	
gesis FLEX DALI output 83.020.0630.0		gesis EIB M2 Switching/dimming output 83.020.1026.x					
Male, screw connection only DALI signal		Male, screw connection		Male, spring clamp connection		Male, screw connection	
							
91.922.3453.0		Test plug 92.954.4453.0 92.002.5353.0		Test plug 91.952.4353.0 92.002.5453.0		92.954.3353.0	
Male – free end, only DALI signal Male – female, only DALI signal, 2 x 1,5 H04VV-F (PVC)		Male – free end 5 x 1.5 H05VV-F (PVC)		Male – free end		Male – free end 5 x 0.75 Ölflex Classic (PVC)	
							
M-f.e: 1.0 91.222.1004.9 M-f.e: 8.0 to 91.222.8004.9 M-F: 1.0 92.222.1000.9 M-F: 8.0 to 92.222.8000.9		1.0 92.257.1004.9 8.0 to 92.257.8004.9		on request		4.0 99.332.6200.0 8.0 99.336.6200.0	
Male – female, DALI + mains p.supply PVC: 1,5 mm² H04VV-F halogen free: 1,5 mm² H05Z1Z1-F		Male – female 5 x 1.5 H05VV-F (PVC)		Male – female		Male – female 5 x 0.75 Ölflex Classic (PVC)	
							
0,5 m PVC 99.404.9999.8 0,5 m halogen free 99.405.9999.8		1.0 92.257.1000.9 8.0 to 92.257.8000.9		on request		4.0 99.342.6200.0 8.0 99.346.6200.0	

Connector system in IP20 format for Inputs / Incoming supply



GST 18i4, coding 2, pebble gray		GST 18i3, coding 1, black		GST 18i5, coding 1, black		BST 14i2, coding 1, green	
Length m	Part No.	Length m	Part No.	Length m	Part No.	Length m	Part No.
Use for binary input 230V		Use for mains feed 1-phase, 3-pole		Use for mains feed 3-phase, 5-pole		Use for KNX feed KNX-TP, SELV	
gesis EIB M2 Input 230V 83.020.0214.x		gesis EIB V Combination actuator 83.020.0212.4 Switching/dimming output 83.020.0213.4 Gateway 83.020.0220.1 Gateway 83.020.0220.3 Sunblind output 83.020.0221.4 Sunblind output 83.020.0222.4 Switching output 83.020.0225.4 gesis RC Switching output 83.020.0500.x Sunblind output 83.020.0501.x gesis FLEX Base modules 83.020.0601.x Feed modules 83.020.0611.x		gesis EIB V Combination actuator 83.020.0212.0 Switching/dimming output 83.020.0213.0 Switching output 83.020.0214.0 Gateway 83.020.0220.0 Gateway 83.020.0220.2 Sunblind output 83.020.0221.0 Switching output 83.020.0225.0 gesis EIB M2 Base modules 83.020.1020.0 gesis FLEX Base modules 83.020.0600.x Feed modules 83.020.0610.x		gesis EIB V Combination actuator 83.020.0212.x Switching/dimming output 83.020.0213.x Switching output 83.020.0214.0 Gateways 83.020.0220.x Sunblind output 83.020.0221.x Sunblind output 83.020.0222.4 Switching output 83.020.0225.x gesis EIB M2 Base modules 83.020.1020.0 gesis FLEX Base modules 83.020.060x.x	
Male, screw connection		Female, screw connection		Female, screw connection		Female, spring clamp connection	
							
Test plug 92.944.3553.0 92.002.5053.0		92.931.3053.1		92.953.4053.1		93.421.0553.1	
Male – free end 4 x 1.5 H05VV-F (PVC)		Female – free end 3 x 1.5 H05VV-F (PVC)		Female – free end 5 x 1.5 H05VV-F (PVC)		Female – free end 2x2x0.8 FB-2Y(ST)2Y (PVC)	
							
1.0 92.207.1004.3 8.0 to 92.207.8004.3		1.0 92.232.1004.1 8.0 to 92.232.8004.1		1.0 92.257.1003.1 8.0 to 92.257.8003.1		1.0 94.425.1003.7 8.0 to 94.425.8003.7	
Male – female 4 x 1.5 H05VV-F (PVC)		Male – female 3 x 1.5 H05VV-F (PVC)		Male – female 5 x 1.5 H05VV-F (PVC)		Male – female 2x2x0.8 FB-2Y(ST)2Y (PVC)	
							
1.0 92.207.1000.3 8.0 to 92.207.8000.3		1.0 92.232.1000.1 8.0 to 92.232.8000.1		1.0 92.257.1000.1 8.0 to 92.257.8000.1		1.0 94.425.1000.7 8.0 to 94.425.8000.7	

Connector system in IP 20 format for Incoming supply

for gesis® EIB V

Power/KNX flat cable
Power: GST 18i5/i3 black
KNX: BST 14i2 green

Flat cable 5-pole + 2-pole

PVC	00.702.0323.9
Halogen-free	00.709.0323.9

IDC connection
Flat cable adapter 5-pole

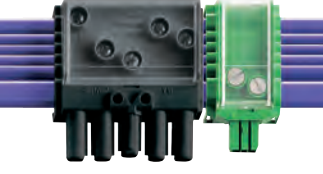

Power	92.051.0353.1
KNX	93.421.0853.0

IDC connection
Flat cable adapter 3-pole



Power tap L1	92.031.4153.1
Power tap L2	92.031.4253.1
Power tap L3	92.031.4353.1
KNX	93.421.1153.0

IDC connection
KNX flat cable adapter





Without spacer	93.421.0853.0
With spacer	93.421.1153.0

for gesis® RC

Power/KNX flat cable
Power: GST 18i3 black

Flat cable 5-pole

PVC	00.702.0303.7
Halogen-free	00.709.0303.7

IDC connection
Flat cable adapter 3-pole



Power tap L1-L3	92.051.0553.1
Power tap L1	92.031.5153.1
Power tap L2	92.031.5253.1
Power tap L3	92.031.5353.1

Flat cable accessories



Sheath stripping tool	95.350.0200.0
Cable cutter	95.300.0300.0

Cable clips for flat cable



For 2.5 mm²	05.562.3000.0
For 10 and 16 mm²	05.563.9753.0

Lock for various connections

Locking devices female – male for cables

Locking device
 Locking devices must be provided for all pluggable connections (except for BST 14i2, GST 15i5).



white	05.587.3156.0
black	05.587.3156.1

Locking devices for the incoming supply of devices

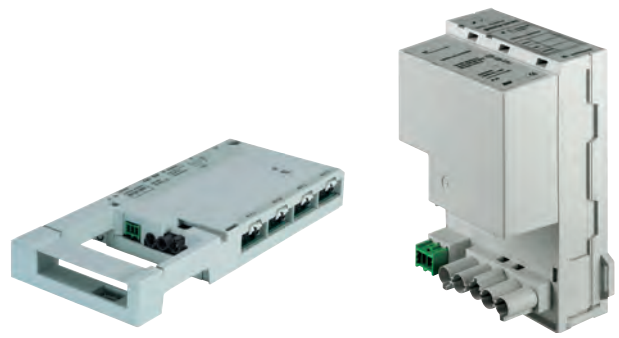

gesis RC / EIB V	83.020.0225.0	gesis EIB M2	83.020.1020.0
------------------	---------------	--------------	---------------

Locking device combinations	Incoming supply gesis® RC/EIB V	Incoming supply gesis® EIB M2
Flat cable adapter GST 18i3 power 3-pole	05.590.4556.1 (bl) 05.590.4556.0 (wh)	–
Flat cable adapter GST 18i3 power 5-pole	05.590.4556.1 (bl) 05.590.4556.0 (wh)	05.590.4556.1 (bl) 05.590.4556.0 (wh)
GST 18i3/i5 connector (not for snap-in and distribution blocks)	05.587.3156.1 (bl) 05.587.3156.0 (wh)	05.587.3156.1 (bl) 05.587.3156.0 (wh)

Connector system RST in IP 66/68 (3m; 2h)/69K format for incoming supply, output, accessories

Length m/Cable Ø	Part No.	Length m/Cable Ø	Part No.	Length m/Cable Ø	Part No.	Length m	Part No.
Incoming supply Power 3-pole RST 20i3 black		Output (voltage) LED/LV halogen RST 20i2 gray		Output (power) LED RST 20i2 brown		Covers RST 20i2 and RST 20i3	
Female, screw connection		Female, screw connection		Female, screw connection		Female, cover, black	
							
6 – 10 mm 10 – 14 mm	96.031.4053.1 96.031.4153.1	6 – 10 mm	92.021.4050.8	6 – 10 mm	96.021.4051.4	Not captive against loss Captive against loss	Z5.564.4553.1 99.414.6205.2
Male, screw connection		Male, screw connection		Male, screw connection		Male, cover, black	
							
6 – 10 mm 10 – 14 mm	96.032.4053.1 96.032.4153.1	6 – 10 mm	96.022.4050.8	6 – 10 mm	96.022.4051.4	Not captive against loss Captive against loss	05.564.4453.1 99.416.6205.2
Female – Male H07RN-F 2x15*)		Female – Male H07RN-F 2x15*)		Female – Male H07RN-F 2x15*)		Jumperplug RST 20i2 brown Note: Only use jumper plug for serial distribution box 99.910.0000.7	
							
1.0 to 8.0 to	96.222.1030.1 96.222.8030.1	1.0 to 8.0 to	96.222.1032.8 96.222.8032.8	1.0 to 8.0 to	96.222.1032.4 96.222.8032.4		96.537.0000.7
Distribution block 1I/3O parallel		Distribution block 1I/3O parallel		Note: For LED applications with constant current supply, the luminaires have to be connected in series. The serial distribution block has been especially designed for this purpose. Outputs not used must be closed with the jumper plug. Circuit diagram 1I/3O serial		Distribution block 1I/3O serial	
							
With mounting option Without mounting option	96.030.0153.0 96.030.0253.0	With mounting option Without mounting option	96.020.0150.8 96.020.0250.8			With mounting option	99.910.0000.7

*) Other cables/designs available on request (see also catalog **gesis®RST®**)



More detailed product informations:

- 0407.1 **Light**
Solutions for the electrical connection of luminaires
- 0418.0 **GaLaBau**
Steckbare Elektroinstallation für den Außenbereich
- 0670.1 **gesis®**
Pluggable Electrical Installation for indoors
- 0690.1 **gesis®RST®**
Pluggable electrical installation in highest protection (IP6X)
- 0695.1 **gesis®RST® MINI**
Smallest pluggable installation connector with highest type of protection
- 0701.1 **gesis®FLEX**
Room for the future.
Decentralized room automation modular - compact - pluggable
- 0404.1 **Electronics with pay back**
Decentralized building automation with plug and play
Educational facilities
- 0408.1 **smart Installation**
Building a green future
Pluggable, decentralized electrical installation for sustainable building
- 0409.1 **gesis®RAN**
Intelligent Deal
Custom distribution boxes for building automation solutions

Available directly from our download center on the Internet in PDF format; product information also in e-CAT at <http://eshop.wieland-electric.com>

Other products for building installation. Mains power devices, overvoltage protection, DIN rail terminal blocks.



Signal conditioning for control and our connection technology

Every time current flows and signals are processed, the **interface** products of Wieland Electric reveal their strength. Through the wide range of relays, the components for power supply, and the overvoltage protection units as well as the transfer and analog modules, your application will be a real all-rounder as well.

Set the signals with our **interface** technology and innovative DIN rail terminal blocks **fasis BIT** and **selos BIT**.

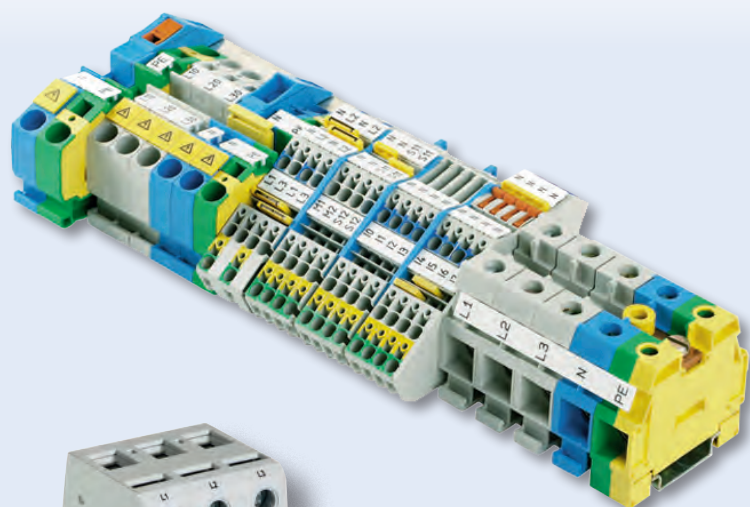

For more detailed product information:

0800.1 **interface** – catalog
Solutions for the control cabinet

0500.1 **selos / fasis** – catalog
DIN rail terminal blocks with screw, tension spring and push-in connection technologies



Protection against overvoltage

wietap systems are overvoltage arresters for voltage and signal coupling which protect electric and electronic systems against high-power overvoltage (e.g. in case of lightning strikes).

Features

- Discharge capacity of up to 100 kA, type 1 to 3
- Modules are pluggable, vibration and shock resistant acc. to EN 60968-2
- Energetically coordinated for all network systems
- Function/defect indication acc. to VDE 0100-534 for each path
- Fuse protection through follow current limitation



Reliable supply of control units

The **wipos** series contains current supplies which have a central function in the control cabinet. Their reliability has an important influence on the availability of machines or processes. Thus, a robust and proven power supply system is essential.

Features

- Number of phases: 1 to 3 phases
- Rated voltage: 0.42 ... 40 A
- Capacity: 100% up to +60 °C
- Series or parallel connection possible
- PFC technology



Network and remote maintenance technology

Our Ethernet switches provide a part of the Ethernet physical layer – no matter whether on a copper or FO basis. Within the automation technology, Ethernet connections are now the standard. The combination of VPN industrial routers (mobile radio or LAN-to-LAN) with the Wie-Service24 VPN Service Portal allows a global and future-proof online remote maintenance.

Features

- Redundant power supply
- Fast Ethernet and Giga Ethernet
- GSM, GPRS, EDGE, HSPA, LTE
- VPN server and routers for a configuration as simple as possible



DIN rail terminal blocks for installation distribution boards

The series **fasis** BIT and **selos** BIT are especially tailored to the requirements inside distribution boards. No matter whether you choose push-in, tension spring or screw connection – space-saving designs, service-friendly testability features and short installation times are the key characteristics of our BIT terminal blocks. All DIN rail terminal blocks are compliant with the erection rules for power installations and safe power supplies and are designed for use in public buildings.

Features and variants

- Flexible, universal, and maintenance-free connections
- Highest contact forces - lowest contact resistances
- Flexible distribution of energy and potential

Index: Part No., type, group, page

00.702.0303.7	■ gesis	CON	87	83.020.0500.2	■ gesis	RC	64	83.020.1021.0	■ gesis	EIB M2	52
00.702.0323.9	■ gesis	CON	87	83.020.0501.1	■ gesis	RC	64	83.020.1022.0	■ gesis	EIB M2	52
00.709.0303.7	■ gesis	CON	87	83.020.0501.2	■ gesis	RC	64	83.020.1023.0	■ gesis	EIB M2	52
00.709.0323.9	■ gesis	CON	87	83.020.0502.0	■ gesis	RC	65	83.020.1024.0	■ gesis	EIB M2	53
05.562.3000.0	■ gesis	CON	87	83.020.0503.0	■ gesis	EIB RM	47	83.020.1026.0	■ gesis	EIB M2	53
05.563.9753.0	■ gesis	CON	87	83.020.0503.0	■ gesis	EIB V	59	83.020.1404.0	■ gesis	KNX	37
05.564.4453.1	■ gesis	RST	81	83.020.0503.0	■ gesis	RC	69	83.020.1405.0	■ gesis	KNX	37
05.564.4453.1	■ gesis	RST	88	83.020.0504.0	■ gesis	RC	64	83.020.1406.0	■ gesis	KNX	37
05.587.3156.0	■ gesis	CON	87	83.020.0504.0	■ gesis	RST	80	83.020.1413.0	■ gesis	KNX	40
05.587.3156.1	■ gesis	CON	87	83.020.0504.1	■ gesis	RC	64	83.020.1414.0	■ gesis	KNX	40
83.020.0110.1	■ gesis		73	83.020.0504.1	■ gesis	RST	80	83.020.1415.0	■ gesis	KNX	40
83.020.0110.2	■ gesis		73	83.020.0505.0	■ gesis	RC	64	83.020.1416.0	■ gesis	KNX	41
83.020.0110.3	■ gesis		73	83.020.0505.0	■ gesis	RST	80	83.020.1417.0	■ gesis	KNX	41
83.020.0111.1	■ gesis		73	83.020.0506.0	■ gesis	RC	65	83.020.1418.1	■ gesis	KNX	40
83.020.0111.2	■ gesis		73	83.020.0600.1	■ gesis	FLEX	13	84.990.1242.0	■ gesis		74
83.020.0115.1	■ gesis		73	83.020.0601.0	■ gesis	FLEX	13	84.990.1243.0	■ gesis		74
83.020.0116.1	■ gesis		73	83.020.0601.1	■ gesis	FLEX	13	91.222.1004.6	■ gesis	CON	84
83.020.0120.0	■ gesis		74	83.020.0610.0	■ gesis	FLEX	14	91.222.1004.9	■ gesis	CON	85
83.020.0120.1	■ gesis		74	83.020.0610.1	■ gesis	FLEX	14	91.222.8004.6	■ gesis	CON	84
83.020.0212.0	■ gesis	EIB V	59	83.020.0611.0	■ gesis	FLEX	14	91.222.8004.9	■ gesis	CON	85
83.020.0212.4	■ gesis	EIB V	59	83.020.0611.1	■ gesis	FLEX	14	91.257.0500.2	■ gesis	FLEX	23
83.020.0213.0	■ gesis	EIB V	59	83.020.0622.0	■ gesis	FLEX	15	91.257.1000.2	■ gesis	FLEX	23
83.020.0213.4	■ gesis	EIB V	59	83.020.0622.1	■ gesis	FLEX	15	91.922.3353.0	■ gesis	CON	84
83.020.0214.0	■ gesis	EIB V	58	83.020.0623.0	■ gesis	FLEX	16	91.922.3453.0	■ gesis	CON	85
83.020.0220.0	■ gesis	EIB V	59	83.020.0623.1	■ gesis	FLEX	16	91.952.4353.0	■ gesis	CON	85
83.020.0220.0	■ gesis	RC	66	83.020.0624.0	■ gesis	FLEX	17	92.002.5053.0	■ gesis	CON	86
83.020.0220.1	■ gesis	EIB V	59	83.020.0624.1	■ gesis	FLEX	17	92.002.5153.1	■ gesis	CON	84
83.020.0220.1	■ gesis	RC	66	83.020.0626.0	■ gesis	FLEX	16	92.002.5253.1	■ gesis	CON	84
83.020.0220.2	■ gesis	EIB V	59	83.020.0626.1	■ gesis	FLEX	16	92.002.5353.0	■ gesis	CON	85
83.020.0220.2	■ gesis	RC	66	83.020.0627.0	■ gesis	FLEX	17	92.002.5453.0	■ gesis	CON	85
83.020.0220.3	■ gesis	EIB V	59	83.020.0627.1	■ gesis	FLEX	17	92.021.4050.8	■ gesis	RST	88
83.020.0220.3	■ gesis	RC	66	83.020.0628.0	■ gesis	FLEX	18	92.030.0153.1	■ gesis		73
83.020.0221.0	■ gesis	EIB V	58	83.020.0628.0	■ gesis	RC	66	92.031.4253.1	■ gesis	CON	87
83.020.0221.4	■ gesis	EIB V	58	83.020.0628.1	■ gesis	FLEX	18	92.031.4353.1	■ gesis	CON	87
83.020.0222.4	■ gesis	EIB V	58	83.020.0628.1	■ gesis	RC	66	92.031.5253.1	■ gesis	CON	87
83.020.0225.0	■ gesis	EIB V	58	83.020.0630.0	■ gesis	FLEX	15	92.031.5353.1	■ gesis	CON	87
83.020.0225.0	■ gesis	CON	87	83.020.0630.1	■ gesis	FLEX	15	92.207.1000.1	■ gesis	CON	84
83.020.0225.4	■ gesis	EIB V	58	83.020.0660.0	■ gesis	FLEX	18	92.207.1000.3	■ gesis	CON	86
83.020.0400.3	■ gesis	EIB RM	46	83.020.0661.0	■ gesis	FLEX	18	92.207.1004.1	■ gesis	CON	84
83.020.0401.0	■ gesis	EIB RM	46	83.020.0662.0	■ gesis	FLEX	18	92.207.1004.3	■ gesis	CON	86
83.020.0402.0	■ gesis	EIB RM	47	83.020.0663.0	■ gesis	FLEX	18	92.207.8000.1	■ gesis	CON	84
83.020.0403.0	■ gesis	EIB RM	47	83.020.0667.0	■ gesis	FLEX	19	92.207.8000.3	■ gesis	CON	86
83.020.0404.0	■ gesis	EIB RM	48	83.020.0900.0	■ gesis	RC	64	92.207.8004.1	■ gesis	CON	84
83.020.0405.0	■ gesis	EIB RM	48	83.020.0900.0	■ gesis	RST	81	92.207.8004.3	■ gesis	CON	86
83.020.0406.0	■ gesis	EIB RM	49	83.020.0901.0	■ gesis	RC	64	92.222.1000.6	■ gesis	CON	84
83.020.0407.0	■ gesis	EIB RM	48	83.020.0901.0	■ gesis	RST	81	92.222.1000.9	■ gesis	CON	85
83.020.0408.0	■ gesis	EIB RM	47	83.020.0902.0	■ gesis	RC	64	92.222.8000.6	■ gesis	CON	84
83.020.0408.0	■ gesis	RC	65	83.020.0902.0	■ gesis	RST	80	92.222.8000.9	■ gesis	CON	85
83.020.0409.0	■ gesis	EIB RM	48	83.020.0903.0	■ gesis	RC	64	92.232.1000.1	■ gesis	CON	84
83.020.0410.0	■ gesis	EIB RM	49	83.020.0903.0	■ gesis	RST	80	92.232.1000.1	■ gesis	CON	86
83.020.0411.0	■ gesis	EIB RM	49	83.020.0904.0	■ gesis	RC	64	92.232.1004.1	■ gesis	CON	84
83.020.0412.0	■ gesis	EIB RM	49	83.020.0904.0	■ gesis	RST	81	92.232.1004.1	■ gesis	CON	86
83.020.0421.0	■ gesis	EIB RM	46	83.020.1020.0	■ gesis	EIB M2	52	92.232.8000.1	■ gesis	CON	84
83.020.0500.0	■ gesis	RC	64	83.020.1020.0	■ gesis	CON	87	92.232.8000.1	■ gesis	CON	86

92.232.8004.1	■	gesis	CON	84	99.401.9999.8	■	gesis	FLEX	23	F0.000.0025.5	■	gesis	RC	68
92.232.8004.1	■	gesis	CON	86	99.404.9999.8	■	gesis	FLEX	23	F0.000.0025.6	■	gesis	RC	68
92.257.1000.1	■	gesis	CON	84	99.404.9999.8	■	gesis	CON	85	F0.000.0025.7	■	gesis	RC	68
92.257.1000.1	■	gesis	CON	86	99.405.9999.8	■	gesis	FLEX	23	F0.000.0025.8	■	gesis	RC	68
92.257.1000.9	■	gesis	CON	85	99.405.9999.8	■	gesis	CON	85	F0.000.0025.9	■	gesis	RC	68
92.257.1003.1	■	gesis	CON	86	99.414.6205.2	■	gesis	RST	81	F0.000.0026.0	■	gesis	RC	68
92.257.1004.1	■	gesis	CON	84	99.414.6205.2	■	gesis	RST	88	F0.000.0026.1	■	gesis	RC	68
92.257.1004.9	■	gesis	CON	85	99.416.6205.2	■	gesis	RST	81	F0.000.0026.2	■	gesis	RC	68
92.257.8000.1	■	gesis	CON	84	99.416.6205.2	■	gesis	RST	88	F0.000.0026.3	■	gesis	RC	68
92.257.8000.1	■	gesis	CON	86	99.448.9999.9	■	gesis		75	F0.000.0026.4	■	gesis	RC	68
92.257.8000.9	■	gesis	CON	85	99.449.9999.9	■	gesis		75	F0.000.0026.5	■	gesis	RC	68
92.257.8003.1	■	gesis	CON	86	99.449.9999.9	■	gesis		75	F0.000.0026.6	■	gesis	RC	68
92.257.8004.1	■	gesis	CON	84	99.449.9999.9	■	gesis		75	F0.000.0026.7	■	gesis	RC	68
92.257.8004.9	■	gesis	CON	85	99.910.0000.7	■	gesis	RST	88	F0.000.0026.8	■	gesis	RC	68
92.931.3053.1	■	gesis	CON	86	F0.000.0002.1	■	gesis	RC	69	F0.000.0026.9	■	gesis	RC	68
92.932.3053.1	■	gesis	CON	84	F0.000.0002.2	■	gesis	RC	69	F0.000.0027.0	■	gesis	RC	68
92.944.3053.1	■	gesis	CON	84	F0.000.0002.3	■	gesis	RC	69	F0.000.0027.1	■	gesis	RC	68
92.944.3553.0	■	gesis	CON	86	F0.000.0002.4	■	gesis	RC	69	F0.000.0027.2	■	gesis	RC	68
92.953.4053.1	■	gesis	CON	86	F0.000.0002.5	■	gesis	RC	69	F0.000.0027.3	■	gesis	RC	68
92.954.3353.0	■	gesis	CON	85	F0.000.0002.6	■	gesis	RC	69	F0.000.0027.4	■	gesis	RC	68
92.954.4053.1	■	gesis	CON	84	F0.000.0003.5	■	gesis	RC	69	F0.000.0027.5	■	gesis	RC	68
92.954.4453.0	■	gesis	CON	85	F0.000.0004.4	■	gesis	RC	69	F0.000.0027.6	■	gesis	RC	68
93.421.0553.1	■	gesis	CON	86	F0.000.0004.5	■	gesis	RC	69	F0.000.0032.0	■	gesis	KNX	38
93.421.1153.0	■	gesis	CON	87	F0.000.0004.6	■	gesis	RC	69	F0.000.0032.1	■	gesis	KNX	38
94.425.1000.7	■	gesis	CON	86	F0.000.0004.7	■	gesis	RC	69	F0.000.0032.3	■	gesis	KNX	39
94.425.1003.7	■	gesis	CON	86	F0.000.0004.8	■	gesis	RC	69	F0.000.0032.4	■	gesis	KNX	39
94.425.8000.7	■	gesis	CON	86	F0.000.0004.9	■	gesis	RC	69	F0.000.0032.5	■	gesis	KNX	39
94.425.8003.7	■	gesis	CON	86	F0.000.0005.6	■	gesis	RC	67	F0.000.0032.6	■	gesis	KNX	39
95.300.0300.0	■	gesis	CON	87	F0.000.0005.7	■	gesis	RC	67	F0.000.0032.7	■	gesis	KNX	38
95.350.0200.0	■	gesis	CON	87	F0.000.0005.8	■	gesis	RC	67	F0.000.0032.8	■	gesis	KNX	38
96.020.0150.8	■	gesis	RST	88	F0.000.0005.9	■	gesis	RC	67	F0.000.0033.8	■	gesis	KNX	41
96.020.0250.8	■	gesis	RST	88	F0.000.0007.5	■	gesis	RC	67	F0.000.0034.5	■	gesis	KNX	36
96.021.4051.4	■	gesis	RST	88	F0.000.0007.6	■	gesis	RC	67	F0.000.0034.6	■	gesis	KNX	36
96.022.4050.8	■	gesis	RST	88	F0.000.0007.7	■	gesis	RC	67	F0.000.0034.7	■	gesis	KNX	36
96.022.4051.4	■	gesis	RST	88	F0.000.0007.8	■	gesis	RC	67	F0.000.0034.8	■	gesis	KNX	36
96.030.0153.0	■	gesis	RST	88	F0.000.0007.9	■	gesis	RC	67	F0.000.0034.9	■	gesis	KNX	36
96.030.0253.0	■	gesis	RST	88	F0.000.0008.0	■	gesis	RC	67	G0.000.0666.6	■	gesis	FLEX	20
96.031.4053.1	■	gesis	RST	88	F0.000.0008.1	■	gesis	RC	67	G0.000.0666.8	■	gesis	FLEX	19
96.031.4153.1	■	gesis	RST	88	F0.000.0008.2	■	gesis	RC	67	G0.000.0666.9	■	gesis	FLEX	20
96.032.4053.1	■	gesis	RST	88	F0.000.0008.3	■	gesis	KNX	41	G0.000.0667.0	■	gesis	FLEX	21
96.032.4153.1	■	gesis	RST	88	F0.000.0009.0	■	gesis	RC	65	G0.000.0667.1	■	gesis	FLEX	21
96.222.1030.1	■	gesis	RST	88	F0.000.0009.2	■	gesis	RC	66	G0.000.0667.2	■	gesis	FLEX	22
96.222.1032.4	■	gesis	RST	88	F0.000.0009.7	■	gesis	RC	69	G0.000.0667.3	■	gesis	FLEX	22
96.222.1032.8	■	gesis	RST	88	F0.000.0017.3	■	gesis	KNX	37	Z5.524.1410.0	■	gesis	FLEX	24
96.222.8030.1	■	gesis	RST	88	F0.000.0024.4	■	gesis	RC	67	Z5.524.1510.0	■	gesis	FLEX	24
96.222.8032.4	■	gesis	RST	88	F0.000.0024.5	■	gesis	RC	69	Z5.524.1610.0	■	gesis	FLEX	24
96.222.8032.8	■	gesis	RST	88	F0.000.0024.6	■	gesis	RC	68	Z5.524.1710.0	■	gesis	FLEX	24
96.537.0000.7	■	gesis	RST	88	F0.000.0024.7	■	gesis	RC	68	Z5.524.1810.0	■	gesis	FLEX	24
99.061.9999.9	■	gesis	FLEX	25	F0.000.0024.8	■	gesis	RC	68	Z5.524.1910.0	■	gesis	FLEX	24
99.332.6200.0	■	gesis	CON	85	F0.000.0025.0	■	gesis	RC	68	Z5.524.2010.0	■	gesis	FLEX	24
99.336.6200.0	■	gesis	CON	85	F0.000.0025.1	■	gesis	RC	68	Z5.564.4553.1	■	gesis	RST	81
99.342.6200.0	■	gesis	CON	85	F0.000.0025.2	■	gesis	RC	68	Z5.564.4553.1	■	gesis	RST	88
99.346.6200.0	■	gesis	CON	85	F0.000.0025.3	■	gesis	RC	68					
99.400.9999.8	■	gesis	FLEX	23	F0.000.0025.4	■	gesis	RC	68					

Hotline, advice Additional information

Technical support

Automation technology:

Phone: +49 951 9324- . . .

- Safety technology **safety** -999
e-mail: safety@wieland-electric.com
- **interface:** -995
Power supply, industrial Ethernet switches, timer relays, measuring and monitoring relays, coupling relays, analog modules, remote I/O, surge protection, passive interfaces, remote power distribution **podis**®
- DIN rail terminal blocks **fasis, selos** -991
Industrial multipole connectors **revos**
PCB terminals and connectors **wiecon**, appliance terminals, european terminal strips, housings for electronic components

Fax: +49 951 9326-991
e-mail: AT.TS@wieland-electric.com

Sales service:

- To contact our sales department regarding availability, delivery schedules, and pricing please call

Phone: +49 951 9324-990

Technical Support

Building services engineering:

Phone: +49 951 9324- . . .

- System connectors for building installation -996
gesis®CON, **gesis**®RAN, **gesis**®ELECTRONIC
 - DIN rail terminal blocks **fasis**BIT, **selos**BIT -991
- Fax: +49 951 9326-996
e-mail: BIT.TS@wieland-electric.com

Additional information for pluggable installation:

- gesis**® (indoor)
Pluggable electrical installation of indoors Part No. 0670.1
- gesis**®RST® (outdoor) Part No. 0690.1

for remote electronic distribution units:

- gesis**®FLEX Part No. 0701.1
- smart** installation Part No. 0408.1
- gesis**®RAN Part No. 0409.1
- Schools Part No. 0404.1

Information about Wieland products in general:

Wieland product overview Part No. 0902.0

General information and news:
www.wieland-electric.com
Visit our eCAT at
<http://eshop.wieland-electric.com>



Our subsidiaries

... and the addresses of our sales partner worldwide are available at:

www.wieland-electric.com



USA
Wieland Electric Inc.
North American Headquarters
 2889 Brighton Road
 Oakville, Ontario L6H 6C9
 Phone +1 905 8298414
 Fax +1 905 8298413
www.wielandinc.com



CANADA
Wieland Electric Inc.
North American Headquarters
 2889 Brighton Road
 Oakville, Ontario L6H 6C9
 Phone +1 905 8298414
 Fax +1 905 8298413
www.wieland-electric.ca



GREAT BRITAIN
Wieland Electric Ltd.
 Riverside Business Centre,
 Walnut Tree Close
 GB-Guildford/Surrey GU1 4UG
 Phone +44 1483 531213
 Fax +44 1483 505029
sales.uk@wieland-electric.com



FRANCE
Wieland Electric SARL.
 Le Céramê Hall 6
 47, avenue des Genottes
 CS 48313
 95803 Cergy-Pontoise Cedex
 Phone +33 1 30320707
 Fax +33 1 30320714
info.adv@wieland-electric.com



SPAIN
Wieland Electric S.L.
 C/ Maria Auxiliadora 2 bajos
 E-08017 Barcelona
 Phone +34 93 2523820
 Fax +34 93 2523825
ventas@wieland-electric.com



ITALY
Wieland Electric S.r.l.
 Via Edison, 209
 I-20019 Settimo Milanese
 Phone +39 02 48916357
 Fax +39 02 48920685
info.italy@wieland-electric.com



BELGIUM
ATEM-Wieland Electric NV
 Bedrijvenpark De Veert 4
 B-2830 Willebroek
 Phone +32 3 8661800
 Fax +32 3 8661828
info.belgium@wieland-electric.com



DENMARK
Wieland Electric A/S
 Vallørækken 26
 DK-4600 Køge
 Phone +45 70 266635
 Fax +45 70 266637
sales.denmark@wieland-electric.com



SWITZERLAND
Wieland Electric AG
 Harzachstrasse 2b
 CH-8404 Winterthur
 Phone +41 52 2352100
 Fax +41 52 2352119
info.swiss@wieland-electric.com



POLAND
Wieland Electric Sp. Zo.o.
 Św. Antoniego 8
 62-080 Swadzim
 Phone +48 61 2225400
 Fax +48 61 8407166
office@wieland-electric.pl



CHINA
Wieland Electric Trading
 Unit 2703
 International Soho City
 889 Renmin Rd., Huang Pu District
 PRC- Shanghai 200010
 Phone +86 21 63555833
 Fax +86 21 63550090
info-shanghai@wieland-electric.com



JAPAN
Wieland Electric Co, Ltd.
 Nisso No. 16 Bldg. 7F
 3-8-8 Shin-Yokohama,
 Kohoku-ku
 Yokohama 222-0033
 Phone +81 45 473 5085
 Fax +81 45 470 5408
info-japan@wieland-electric.com



◀ Informational material for
 downloading from our websites



Headquarters:
Wieland Electric GmbH
Brennerstraße 10 – 14
96052 Bamberg, Germany

Sales Center:
Wieland Electric GmbH
Benzstraße 9
96052 Bamberg, Germany

Phone +49 951 9324-0
Fax +49 951 9324-198
www.wieland-electric.com
info@wieland-electric.com

Industrial technology

Solutions for the control cabinet

- DIN rail terminal blocks
 - Screw, tension spring or push-in connection technology
 - Wire cross sections up to 300 mm²
 - Numerous special functions
 - Software solutions interfacing to CAE systems
- Safety
 - Safe signal acquisition
 - Safety switching devices
 - Modular safety modules
 - Compact safety controllers
 - Application consulting and training
- Network engineering and fieldbus systems
 - Remote maintenance via VPN industrial router and VPN service portal
 - Industrial Ethernet switches
 - PLC and I/O systems, standard and increased environmental conditions
- Interface
 - Power supply units
 - Overvoltage protection
 - Coupling relays, semiconductor switches
 - Timer relays, measuring and monitoring relays
 - Analog coupling and converter modules
 - Passive interfaces

Solutions for field applications

- Decentralized installation and automation technology
 - Electrical installation for wind tower
 - Fieldbus interfaces and motor starters
- Connectors for industrial applications
 - Rectangular and round connectors
 - Aluminium or plastic housings
 - Degree of protection up to IP 69K
 - Current-carrying capacity up to 100 A
 - Connectors for hazardous areas
 - Modular, application-specific technology

PC board terminals and connectors

- Screw or spring clamp connection technology
- Spacings: 3.5 mm to 10.16 mm
- Reflow or wave soldering process

Building and installation technology

- Building installation systems
 - Main power supply connectors IP 20/IP 65 ... IP 69K
 - Bus connectors
 - Low-voltage connectors
 - Power distribution system with flat cables
 - Distribution systems
 - Room automation with KNX and wireless technology
 - DIN rail terminal blocks for electrical installations
 - Overvoltage protection