

# Absolute encoders - bus interfaces

Encoder with solid shaft  $\varnothing 11$  mm and EURO flange B10

Single and multiturn 13 bit ST / 12 or 16 bit MT

SSI / Profibus / CANopen® / DeviceNet / PROFINET

## AMG 11



AMG 11

### Technical data - electrical ratings

Voltage supply	9...30 VDC
Consumption w/o load	$\leq 100$ mA (per interface SSI) $\leq 250$ mA (per interface bus)
Initializing time	$\leq 200$ ms after power on
Interfaces	SSI, Profibus-DPV0, CANopen®, DeviceNet, PROFINET
Function	Multiturn
Transmission rate	9.6...12000 kBaud (Profibus) 10...1000 kBaud (CANopen®) 125...500 kBaud (DeviceNet) 100 MBaud (PROFINET)
Profile conformity	Profibus-DPV0 CANopen® CiA DSP 406 V 3.0 Device Profile Encoder V 1.0 Encoder profile PNO 3.162
Device adress	Rotary switch in bus cover
Steps per turn	8192 / 13 bit
Number of turns	$\leq 65536$ / 16 bit
Additional output signals	Square-wave TTL (RS422) Square-wave HTL
Sensing method	Optical
Code	Gray (version SSI)
Code sequence	CW default
Inputs	SSI clock (version SSI)
Interference immunity	EN 61000-6-2
Emitted interference	EN 61000-6-3
Programmable parameters	Depending on the selected absolute interface
Diagnostic function	Position or parameter error
Status indicator	DUO-LED integrated in bus cover
Approvals	CE, UL approval / E256710

### Features

- Multiturn SSI / Profibus / CANopen® / DeviceNet / PROFINET
- Optical sensing method
- Singleturn 13 bit, multiturn 12 bit / 16 bit
- EURO-flange B10 / solid shaft  $\varnothing 11$  mm
- Multiturn sensing with microGen technologie, without gear or battery
- Available with redundant absolute signals
- Special protection against corrosion

### Optional

- Additional incremental output (TTL / HTL)

### Technical data - mechanical design

Size (flange)	$\varnothing 115$ mm
Shaft type	$\varnothing 11$ mm solid shaft
Flange	EURO flange B10
Protection DIN EN 60529	IP 67
Operating speed	$\leq 3500$ rpm (mechanical)
Operating torque typ.	12 Ncm
Rotor moment of inertia	780 gcm <sup>2</sup>
Admitted shaft load	$\leq 250$ N axial, $\leq 350$ N radial
Materials	Housing: aluminium alloy Shaft: stainless steel
Operating temperature	-20...+85 °C
Resistance	IEC 60068-2-6 Vibration 10 g, 10-2000 Hz IEC 60068-2-27 Shock 100 g, 6 ms
Explosion protection	II 3 G Ex nA IIC T4 Gc (gas) II 3 D Ex tc IIIC T135°C Dc (dust)
Weight approx.	3 kg (depending on version)
Connection	Bus cover Terminal box or flange connector M23, 12 pin (SSI/ incremental)

# Absolute encoders - bus interfaces

## Encoder with solid shaft $\varnothing 11$ mm and EURO flange B10

### Single and multiturn 13 bit ST / 12 or 16 bit MT

### SSI / Profibus / CANopen® / DeviceNet / PROFINET

**AMG 11**

#### Part number

**AMG 11**

- Additional incremental signals
- Z0 Without
- T1024 TTL level, 1024 pulses\*
- T2048 TTL level, 2048 pulses\*
- H1024 HTL level, 1024 pulses\*
- H2048 HTL level, 2048 pulses\*
  
- Absolute share
- 13 13 bit singleturn
- 25 13 bit singleturn + 12 bit multiturn (only S and SS version)
- 29 13 bit singleturn + 16 bit multiturn
  
- Interface/interfaces
- S SSI
- P Profibus
- C CANopen®
- D DeviceNet
- N PROFINET
- SS 2 x SSI
- PS Profibus and SSI
- CS CANopen® and SSI
- DS DeviceNet and SSI
- PP 2 x Profibus
- CP CANopen® and Profibus
- DP DeviceNet and Profibus
- CC 2 x CANopen®
- DC DeviceNet and CANopen®
- DD 2 x DeviceNet

\* The incremental signals are duplicated with configuration SS  
 Please note: additional incremental output signals are not feasible with PP, CP, DP, CC, DC and DD interface.

#### Accessories

##### Connectors and cables

HEK 8 Sensor cable for encoders

##### Mounting accessories

- K 35 Spring washer coupling for solid shaft  $\varnothing 6 \dots 12$  mm
- K 50 Spring washer coupling for solid shaft  $\varnothing 11 \dots 16$  mm
- K 60 Spring washer coupling for solid shaft  $\varnothing 11 \dots 22$  mm

##### Diagnostic accessories

HENQ 1100 Analyzer for encoders

# Absolute encoders - bus interfaces

Encoder with solid shaft  $\varnothing 11$  mm and EURO flange B10

Single and multiturn 13 bit ST / 12 or 16 bit MT

SSI / Profibus / CANopen® / DeviceNet / PROFINET

## AMG 11

### Terminal assignment - Profibus

View A - Connecting terminal in cover

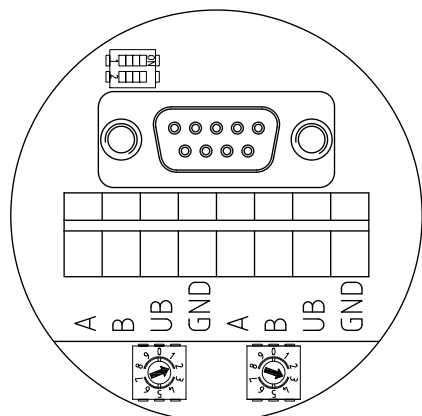

### Terminal significance - Profibus

A	Negative serial data transmission, pair 1 and pair 2
B	Positive serial data transmission, pair 1 and pair 2
UB	Voltage supply 9...30 VDC
GND	Ground connection for UB

Terminals with the same label are internally connected.

### Features - Profibus

Protocol	Profibus DP V0
Profibus features	Device Class 1 and 2
Data Exch. functions	Input: Position value Output: Preset value
Preset value	The „Preset“ parameter can be used to set the encoder to a predefined value that corresponds to a specific axis position of the system.
Parameter functions	Rotating direction: The relationship between the rotating direction and rising or falling output code values can be set in the operating parameter. Scaling: The parameter values set the number of steps per turn and the overall resolution.
Diagnostic	The encoder supports the following error messages: - Position error
Default settings	User address 00

### Terminal assignment - CANopen®

View A - Connecting terminal in cover

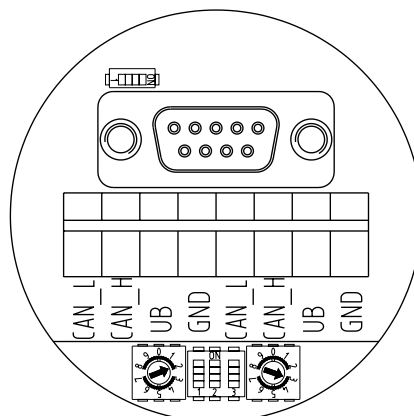

### Terminal significance - CANopen®

CAN_L	CAN Bus signal (dominant low)
CAN_H	CAN Bus signal (dominant high)
UB	Voltage supply 9...30 VDC
GND	Ground connection for UB

Terminals with the same label are internally connected.

### Features - CANopen®

Protocol	CANopen®
CANopen® features	Device class 2 CAN 2.0B
Device profile	CANopen® CiA DSP 406, V 3.0
Operation modes	Polling mode (asynch, via SDO) Cyclic mode (asynch-cyclic) Synch mode (synch-cyclic) Acyclic mode (synch-acyclic)
Diagnostic	The encoder supports the following error messages: - Position error
Default settings	User address 00

# Absolute encoders - bus interfaces

## Encoder with solid shaft $\varnothing 11$ mm and EURO flange B10

### Single and multiturn 13 bit ST / 12 or 16 bit MT

### SSI / Profibus / CANopen® / DeviceNet / PROFINET

AMG 11

#### Terminal assignment - DeviceNet

View A - Connecting terminal in cover

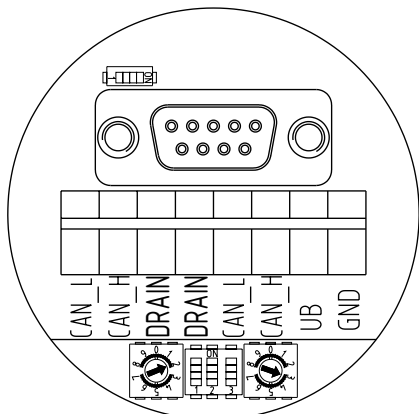

#### Terminal significance - DeviceNet

CAN_L	CAN bus Signal (dominant Low)
CAN_H	CAN bus Signal (dominant High)
DRAIN	Shield connection
UB	Voltage supply 9...30 VDC
GND	Ground connection relating to UB

Terminals of the same significance are internally connected and identical in their functions. Max. load on the internal terminal connections UB-UB and GND-GND is 1 A each.

#### Features - DeviceNet

Protocol	DeviceNet
DeviceNet features	Device Profile for Encoders V 1.0
Operating modes	I/O-Polling Cyclic Change of State
Preset value	The „Preset“ parameter can be used to set the encoder to a predefined value that corresponds to a specific axis position of the system. The offset of encoder zero point and mechanical zero point is stored in the encoder.
Parameter functions	Rotating direction: The relationship between the rotating direction and rising or falling output code values can be set in the operating parameter. Scaling: The parameter values set the number of steps per turn and the overall resolution.
Diagnostic	The encoder supports the following error warnings: - Position and parameter error
Default settings	User address 00

#### Terminal assignment - PROFINET

View D - View onto connector „Voltage supply“

male	Connection	Description
1	UB	Voltage supply 9...30 VDC
2	-	Do not use
3	GND	Ground for UB
4	-	Do not use

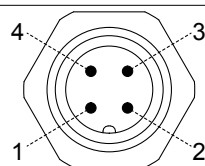

Connector M12 (male)  
4-pin, A-coded

View E - View into connector „Data transmission“

female	Connection	Description
1	TxD+	Transmission data+
2	RxD+	Receiving data+
3	TxD-	Transmission data-
4	RxD-	Receiving data-

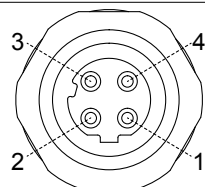

Connector M12 (female)  
4-pin, D-coded

#### Features - PROFINET

Bus protocol	PROFINET
Device profile	Encoder profile PNO 3.162
Features	100 Mbaud Fast Ethernet IP address programmable Realtime (RT) Class 1, IRT
Class 2,	IRT Class 3
Process data	Position value 32 bit input data

# Absolute encoders - bus interfaces

Encoder with solid shaft  $\varnothing 11$  mm and EURO flange B10

Single and multiturn 13 bit ST / 12 or 16 bit MT

SSI / Profibus / CANopen® / DeviceNet / PROFINET

## AMG 11

### Terminal assignment - Incremental and/or SSI

View B - Connecting terminal in cover

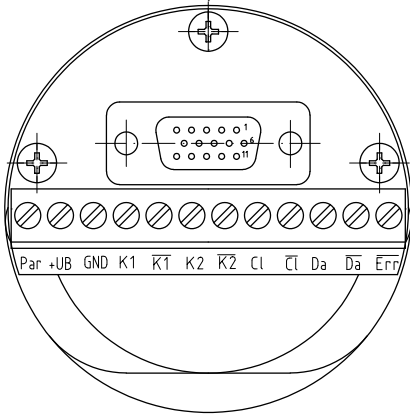

View C - Option

Flange connector M23, 12-pin, male contacts, counter-clockwise

Male Assignment

Pin 1	$\overline{K2}$
Pin 2	Clock *
Pin 3	Data *
Pin 4	$\overline{Data}$ *
Pin 5	K1
Pin 6	$\overline{K1}$
Pin 7	Param *
Pin 8	K2
Pin 9	$\overline{Error}$ *
Pin 10	GND
Pin 11	$\overline{Clock}$ *
Pin 12	+UB *

\* only for SSI

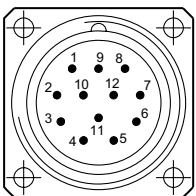

### Data transfer

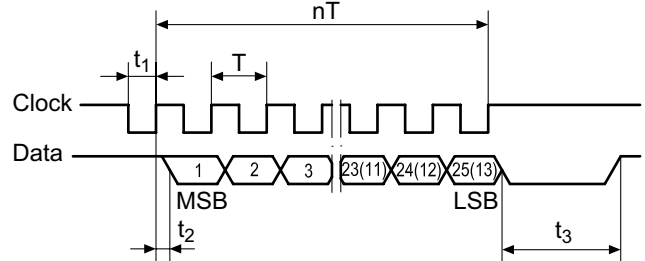

$$T = 1.25 \dots 10 \mu\text{s}$$

$$t_1 = 0.63 \dots 5 \mu\text{s}$$

$$t_2 \leq 0.4 \mu\text{s}$$

$$t_3 = 12 \dots 30 \mu\text{s}$$

$$n = \text{Number of bits}$$

$$\text{Clock frequency} = 100 \dots 800 \text{ kHz}$$

### Output signals

Additional incremental signals at positive rotating direction

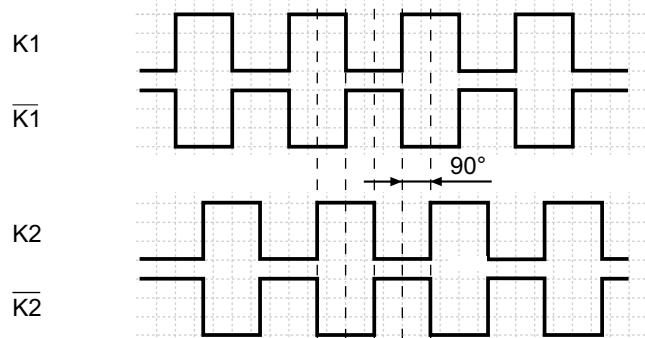

# Absolute encoders - bus interfaces

Encoder with solid shaft  $\varnothing 11$  mm and EURO flange B10

Single and multiturn 13 bit ST / 12 or 16 bit MT

SSI / Profibus / CANopen® / DeviceNet / PROFINET

AMG 11

## Dimensions

### AMG 11 - SSI / Profibus / CANopen® / DeviceNet

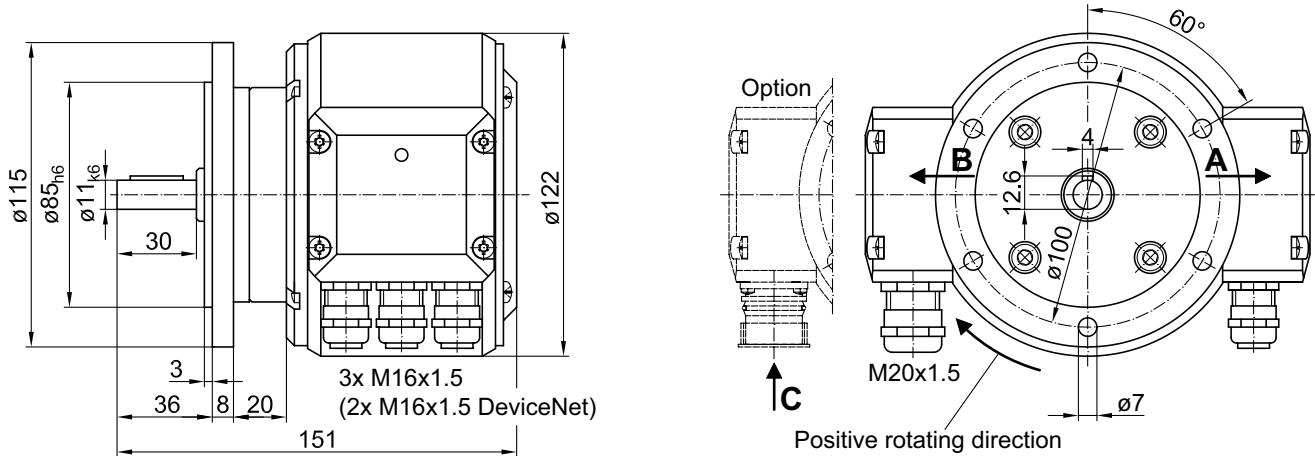

### AMG 11 - PROFINET

