

Preset counters electromechanic

1 preset, subtracting

Display 5 digits, manual/electric reset

FS218, FS219



FS218 - Front panel with screw mount

Features

- Large pulse counter with one preset
- Subtracting
- Display 5-digits
- Manual and electric reset

Technical data - electrical ratings

Voltage supply	24/110 VAC $\pm 10\%$ (50/60 Hz) 230 VAC $+6/-10\%$ (50/60 Hz) 24 VDC $\pm 10\%$
Residual ripple	<48 %
Nominal frequency	50 / 60 Hz
Pulse ratio	1:1
Service life	100 million impulses Electric reset operations: Approx. 1 million
Preset	1 preset
Output contact	Change-over contact by micro-switch, one-pole
Switching voltage	230 VAC / VDC
Switching current	2 A (VAC) 1 A (VDC)
Switching capacity	100 VA / 30 W
Limit switch lifetime	1 million switching cycles
Spark extinguisher	Recommended for inductive load
Standard DIN EN 61010-1	Protection class II Overvoltage category II Pollution degree 2
Emitted interference	DIN EN 61000-6-3
Interference immunity	DIN EN 61000-6-2

Technical data - mechanical design

Display	White numbers on black
Number of digits	5-digits
Digit height	8 mm
Count mode	1 impulse = 1 count
Step-by-step switching	Subtracting in 2 half steps
Measuring range	99 999
Ambient temperature	-5...+50 °C
Storage temperature	-20...+70 °C
Relative humidity	80 % non-condensing
Protection DIN EN 60529	IP 41
Housing type	Built-in housing
Connection	Plug-in terminal connector, 10-pin
Mounting	Front panel with 4 screws
Dimensions W x H x L	144 x 72 x 129 mm
Cutout dimensions	113 x 61 mm (+0.5)
Mounting depth	129 mm
Material	Housing: Hostaform POM, black

FS218

Reset	Manual by button to preset
Weight approx.	650 g

FS219

Reset	Manual by button and electric reset to preset
Weight approx.	850 g

Preset counters electromechanic

1 preset, subtracting

Display 5 digits, manual/electric reset

FS218, FS219

Trigger level

Count	Voltage DC	Voltage AC
Power	4 W	5 VA
Min. pulse duration	50 ms	50 ms
Min. pulse interval	50 ms	50 ms
Switch on time (at 25 °C)	100 %	100 %

Electr. reset	Voltage DC	Voltage AC
Power	30 W	42 VA
Min. pulse duration	300 ms	300 ms
Min. pulse interval	9x pulse duration	9x pulse duration
Switch on time (at 25 °C)	10 % max. 1 min	10 % max. 1 min

Connection diagram

FS218

DC

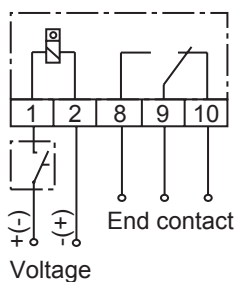

AC

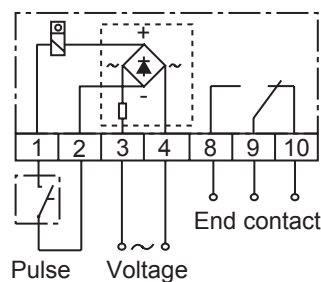

FS219

DC

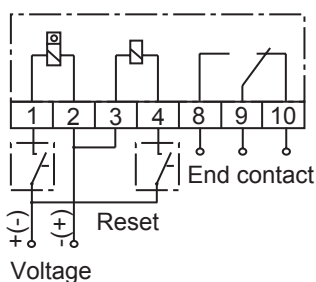

AC

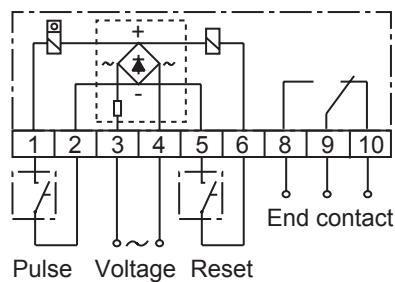

Accessories

Front panels

Z 100.04A Front panel with transparent protective cover, for socket box 114 x 61 mm

Preset counters electromechanic

1 preset, subtracting

Display 5 digits, manual/electric reset

FS218, FS219

Part number

With reset button

FS218. 550B B

Display
B 5-digits 99999

Voltage
A3 24 VDC
B5 24 VAC
B8 110 VAC
B9 230 VAC

Reset
550B With reset button

With button reset and electrical reset

FS219. 550B B

Display
B 5-digits 99999

Voltage
A3 24 VDC
B5 24 VAC
B8 110 VAC
B9 230 VAC

Reset
550B With button reset and electrical reset

Dimensions

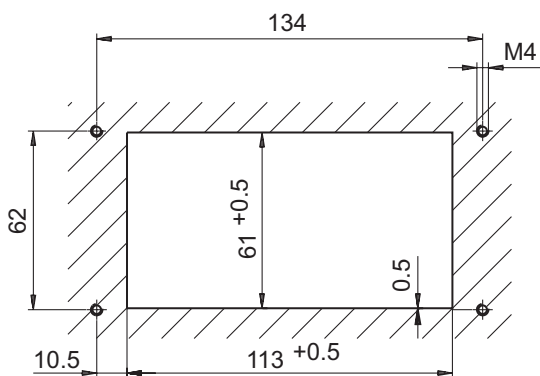
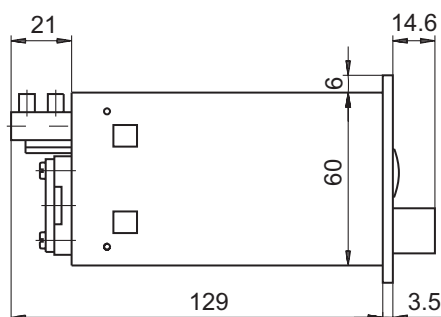
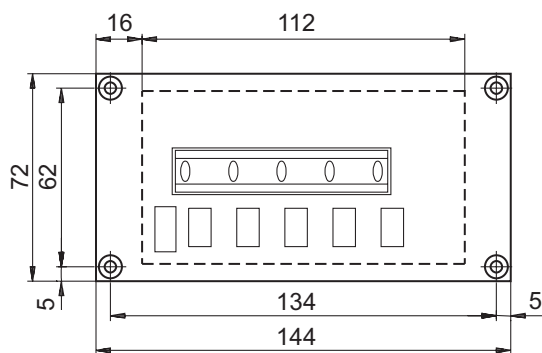

Preset counters electromechanic
1 preset, subtracting
Display 5 digits, manual/electric reset

FS218, FS219
