

Absolute encoders - bus interfaces

Blind / through hollow shaft or cone shaft (1:10)

Profibus DPV0 or DPV2 / 13 bit ST / 16 bit MT / Speed switch

HMG10 - Profibus DP



HMG 10 - picture similar

Technical data - electrical ratings

Voltage supply	10...30 VDC
Short-circuit proof	Yes
Consumption w/o load	≤200 mA
Initializing time	≤500 ms after power on
Interface	Profibus-DPV0/V2
Function	Multiturn
Transmission rate	9.6...12000 kBaud
Device address	Rotary switch in bus connecting box (type-specific)
Steps per turn	8192 / 13 bit
Number of turns	65536 / 16 bit
Additional outputs	Square-wave HTL/TTL (RS422)
Sensing method	Magnetic
Interference immunity	EN 61000-6-2
Emitted interference	EN 61000-6-3
Programmable parameters	Steps per revolution Number of revolutions Preset, scaling, rotating direction
Diagnostic function	Position or parameter error
Status indicator	DUO-LED in bus connecting box 4 LEDs in device back side
Approvals	CE, UL approval / E256710

Technical data - electrical ratings (speed switches)

Interface	RS485
Switching accuracy	±2 % (or Digit)
Switching outputs	1 output (Open-Collector or Solid State Relay)
Output switching capacity	30 VDC; ≤100 mA
Switching delay time	≤20 ms

Features

- Interface Profibus DPV0 or DPV2
- Magnetic sensing method
- Resolution: singleturn 13 bit, multiturn 16 bit
- Function display via LEDs
- Multiturn sensing with Energy Harvesting technologie, without gear or battery
- Two hybrid bearings, one at each end
- Special protection against corrosion C5-M

Optional

- Integrated speed switch, programmable
- Additional output incremental with zero pulse

Technical data - mechanical design

Size (flange)	ø105 mm
Flange	Support plate, 360° freely positionable
Protection DIN EN 60529	IP 66/IP 67
Operating speed	≤6000 rpm
Range of switching speed	±2...6000 rpm, default 6000 rpm
Operating torque typ.	10 Ncm
Rotor moment of inertia	950 gcm ²
Admitted shaft load	≤450 N axial ≤650 N radial
Materials	Housing: aluminium alloy Shaft: stainless steel
Operating temperature	-40...+85 °C
Relative humidity	95 % non-condensing
Resistance	IEC 60068-2-6 Vibration 30 g, 10-2000 Hz IEC 60068-2-27 Shock 400 g, 1 ms
Corrosion protection	IEC 60068-2-52 Salt mist Complies to ISO 12944-5:1998 Protective paint systems (C5-M)
Weight approx.	2.2 kg (depending on version)
Connection	Bus connecting box Terminal box incremental

HMG10-B - Profibus DP

Shaft type	ø16...20 mm (blind hollow shaft) ø17 mm (cone shaft 1:10)
------------	--

HMG10-T - Profibus DP

Shaft type	ø16...20 mm (through hollow shaft)
------------	------------------------------------

Absolute encoders - bus interfaces

Blind / through hollow shaft or cone shaft (1:10)

Profibus DPV0 or DPV2 / 13 bit ST / 16 bit MT / Speed switch

HMG10 - Profibus DP

Part number

Encoder with blind hollow shaft / cone shaft

HMG10

	-B	H	.				.3		00		.A
--	----	---	---	--	--	--	----	--	----	--	----

Additional output *

0 Without

See also table "Additional output **"

Resolution multiturm

0 Without

6 16 bit

Voltage supply / interface

P0 10...30 VDC, Profibus-DPV0

P2 10...30 VDC, Profibus-DPV2

Connection

5 1x bus connecting box with 3 cable glands M16, radial

3 1x bus connecting box with 3 connectors M12, radial

F 1x bus connecting box with 3 cable glands M16, radial +
1x terminal box with 1 cable gland M20, radial

G 1x bus connecting box with 3 connectors M12, radial +
1x terminal box with 1 cable gland M20, radial

Shaft diameter

6 ø16 mm, central screw

7 ø17 mm cone 1:10, central screw

Z ø20 mm, central screw

Protection

D IP 66 and IP 67, optimized for dusty environments

L IP 66 and IP 67, optimized for oily and wet environments

Flange

H Support for torque arm, shaft insulation hybrid bearing

Speed switch / Programming

Without

D With speed switch *

(Standard: Open Collector, Solid State Relais on request)

* Only for connection F or G

Absolute encoders - bus interfaces

Blind / through hollow shaft or cone shaft (1:10)

Profibus DPV0 or DPV2 / 13 bit ST / 16 bit MT / Speed switch

HMG10 - Profibus DP

Part number

Encoder with through hollow shaft

HMG10

	-T	H	.				.3		00		.A
--	----	---	---	--	--	--	----	--	----	--	----

Additional output *

0 Without

See also table "Additional output **"

Resolution multiturn

0 Without

6 16 bit

Voltage supply / interface

P0 10...30 VDC, Profibus-DPV0

P2 10...30 VDC, Profibus-DPV2

Connection

5 1x bus connecting box with 3 cable glands M16, radial

3 1x bus connecting box with 3 connectors M12, radial

F 1x bus connecting box with 3 cable glands M16, radial +
1x terminal box with 1 cable gland M20, radial

G 1x bus connecting box with 3 connectors M12, radial +
1x terminal box with 1 cable gland M20, radial

Shaft diameter

C \varnothing 16 mm, clamping ring on drive side

F \varnothing 20 mm, clamping ring on drive side

P \varnothing 16 mm, clamping ring on drive side with keyway

Protection

D IP 66 and IP 67, optimized for dusty environments

L IP 66 and IP 67, optimized for oily and wet environments

Flange

H Support for torque arm, shaft insulation hybrid bearing

Speed switch / Programming

Without

D With speed switch *

(Standard: Open Collector, Solid State Relais on request)

* Only for connection F or G

Absolute encoders - bus interfaces

Blind / through hollow shaft or cone shaft (1:10)

Profibus DPV0 or DPV2 / 13 bit ST / 16 bit MT / Speed switch

HMG10 - Profibus DP

Part number - tables

Additional output *

0	(Without)
Q	(8192 ppr TTL/HTL push-pull (Vin=Vout), 6 channels)
P	(8192 ppr TTL (RS422), 6 channels)
G	(5000 ppr TTL/HTL push-pull (Vin=Vout), 6 channels)
H	(5000 ppr TTL (RS422), 6 channels)
K	(4096 ppr TTL/HTL push-pull (Vin=Vout), 6 channels)
J	(4096 ppr TTL (RS422), 6 channels)
7	(3072 ppr TTL/HTL push-pull (Vin=Vout), 6 channels)
8	(3072 ppr TTL (RS422), 6 channels)
9	(2048 ppr TTL/HTL push-pull (Vin=Vout), 6 channels)
4	(2048 ppr TTL (RS422), 6 channels)
5	(1024 ppr TTL/HTL push-pull (Vin=Vout), 6 channels)
6	(1024 ppr TTL (RS422), 6 channels)
1	(512 ppr TTL/HTL push-pull (Vin=Vout), 6 channels)
2	(512 ppr TTL (RS422), 6 channels)

* Only for connection F or G

Accessories

Mounting accessories

11043628	Torque arm M6, length 67-70 mm
11004078	Torque arm M6, length 120-130 mm (≥71 mm)
11002915	Torque arm M6, length 425-460 mm (≥131 mm)
11054917	Insulated torque arm M6, length 67-70 mm
11072795	Insulated torque arm M6, length 120-130 mm (≥71 mm)
11082677	Insulated torque arm M6, length 425-460 mm (≥131 mm)
11077197	Mounting kit for torque arm size M6 and earthing strap
11077087	Mounting and dismounting set

Absolute encoders - bus interfaces

Blind / through hollow shaft or cone shaft (1:10)

Profibus DPV0 or DPV2 / 13 bit ST / 16 bit MT / Speed switch

HMG10 - Profibus DP

Profibus-DP V0 - Terminal assignment

View A¹⁾ - View inside bus connecting box

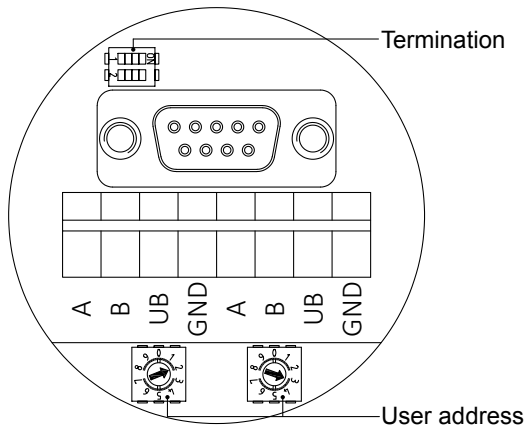

View C¹⁾ - View into connector „Voltage supply“

male	Connection	Description
1	UB	Voltage supply 10...30 VDC
3	GND	Ground connection for UB

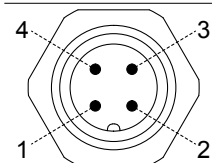

Connector M12 (male)
4-pin, A-coded

View D¹⁾ / View E¹⁾ - View into connector „Data transmission“

male / female	Connection	Description
2	A	Negative serial data transmission
4	B	Positive serial data transmission

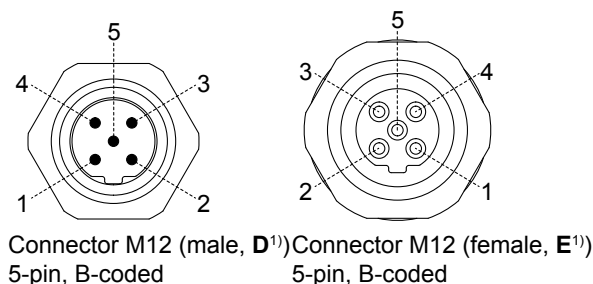

Connector M12 (male, D¹⁾) Connector M12 (female, E¹⁾)
5-pin, B-coded 5-pin, B-coded

Terminals of the same significance are internally connected and identical in their functions. Max. load on the internal terminal connections UB-UB and GND-GND is 1 A each.

Profibus-DP V0 - Features

Bus protocol	Profibus-DP V0
Profibus-Features	Device Class 1 and 2
Data Exch. functions	Input: Position value Output: Preset value
Preset value	The „Preset“ parameter can be used to set the encoder to a pre-defined value that corresponds to a specific axis position of the system.
Parameter functions	Rotating direction: The relationship between the rotating direction and rising or falling output code values can be set in the operating parameter. Scaling: The parameter values set the number of steps per turn and the overall resolution.
Diagnostic	The encoder supports the following error messages: - Position error
Default settings	User address 00

Profibus-DP V0 - Termination

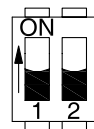

both ON = final user
both OFF = user xx

Profibus-DP V0 - User address

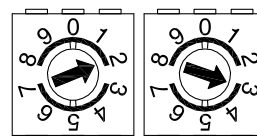

Defined by rotary switch.
Example: User address 23

¹⁾ See dimensions

Absolute encoders - bus interfaces

Blind / through hollow shaft or cone shaft (1:10)

Profibus DPV0 or DPV2 / 13 bit ST / 16 bit MT / Speed switch

HMG10 - Profibus DP

Profibus-DP V2 - Terminal assignment

View A¹⁾ - View inside bus connecting box

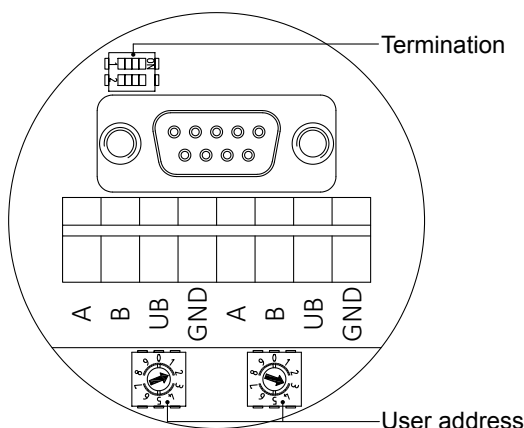

View C¹⁾ - View into connector „Voltage supply“

male	Connection	Description
1	UB	Voltage supply 10...30 VDC
3	GND	Ground connection for UB

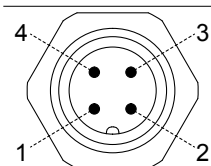

Connector M12 (male)
4-pin, A-coded

View D¹⁾ / View E¹⁾ - View into connector „Data transmission“

male / female	Connection	Description
2	A	Negative serial data transmission
4	B	Positive serial data transmission

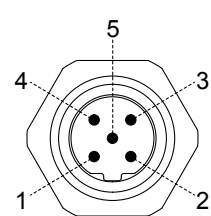

Connector M12 (male, D¹⁾)
5-pin, B-coded

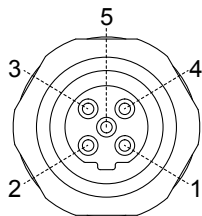

Connector M12 (female, E¹⁾)
5-pin, B-coded

Terminals of the same significance are internally connected and identical in their functions. Max. load on the internal terminal connections UB-UB and GND-GND is 1 A each.

Profibus-DP V2 - Features

Bus protocol	Profibus-DP V2
Profibus-Features	Device Class 3 and 4
Data Exch. functions	Input: Position value Output: Preset value
Preset value	The „Preset“ parameter can be used to set the encoder to a pre-defined value that corresponds to a specific axis position of the system.
Parameter functions	Rotating direction: The relationship between the rotating direction and rising or falling output code values can be set in the operating parameter. Scaling: The parameter values set the number of steps per turn and the overall resolution.
Diagnostic	The encoder supports the following error messages: - Position error
Default settings	User address 00

Profibus-DP V2 - Termination

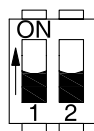

both ON = final user
both OFF = user xx

Profibus-DP V2 - User address

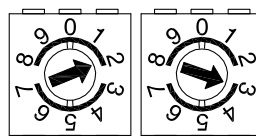

Defined by rotary switch.
Example: User address 23

¹⁾ See dimensions

Absolute encoders - bus interfaces

Blind / through hollow shaft or cone shaft (1:10)

Profibus DPV0 or DPV2 / 13 bit ST / 16 bit MT / Speed switch

HMG10 - Profibus DP

Speed switch/incremental - Terminal significance

+UB	Voltage supply
⊥	Ground
A+	Channel A+
A-	Channel A- (channel A+ inverted)
B+	Channel B+
B-	Channel B- (channel B+ inverted)
R+	Zero pulse (reference signal)
R-	Zero pulse inverted
nE+	System OK+ / error output
nE-	System OK- / error output inverted
SP+ ²⁾	DSL_OUT1 / speed switch (Open-Collector or Solid State Relay)
SP- ²⁾	DSL_OUT2 / speed switch (0 V or Solid State Relay)
SA ²⁾	RS485+ / programming interface
SB ²⁾	RS485- / programming interface

Incremental - Output signals

Version with additional incremental output at positive rotating direction

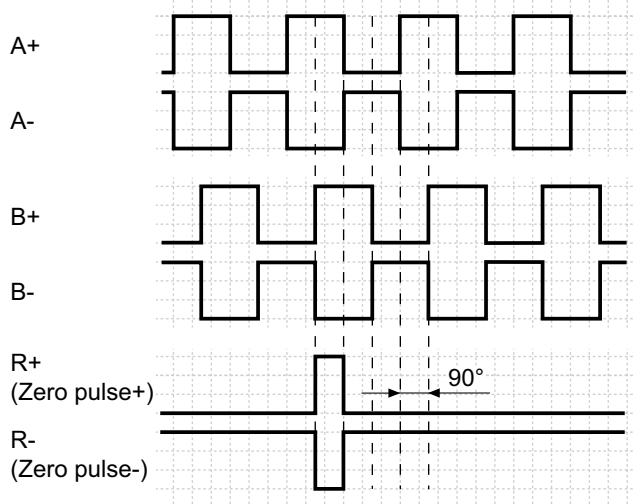

Speed switch/incremental - Terminal assignment terminal box

View B¹⁾

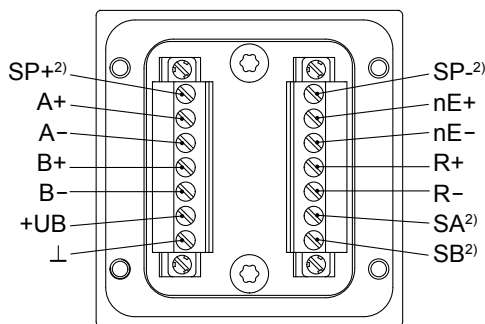

Speed switch - Switching characteristics

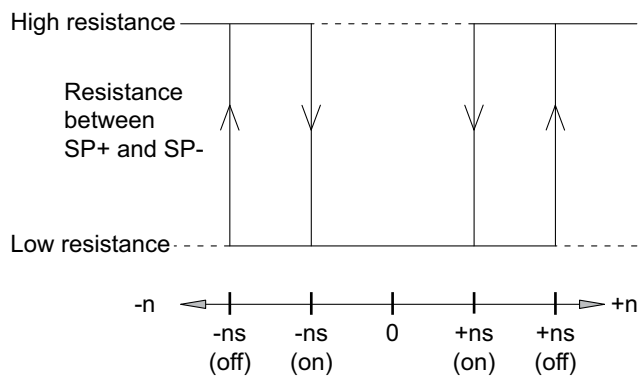

- n = Speed
- +ns (on) = Activation speed at shaft rotation in positive rotating direction¹⁾.
- +ns (off) = Deactivation speed at shaft rotation in positive rotating direction¹⁾.
- ns (on) = Activation speed at shaft rotation in negative rotating direction¹⁾.
- ns (off) = Deactivation at shaft rotation in negative rotating direction¹⁾.

¹⁾ See dimensions

²⁾ Do not use at version without speed switch

Absolute encoders - bus interfaces

Blind / through hollow shaft or cone shaft (1:10)

Profibus DPV0 or DPV2 / 13 bit ST / 16 bit MT / Speed switch

HMG10 - Profibus DP

Dimensions

Blind hollow shaft and cone shaft with radial terminal boxes

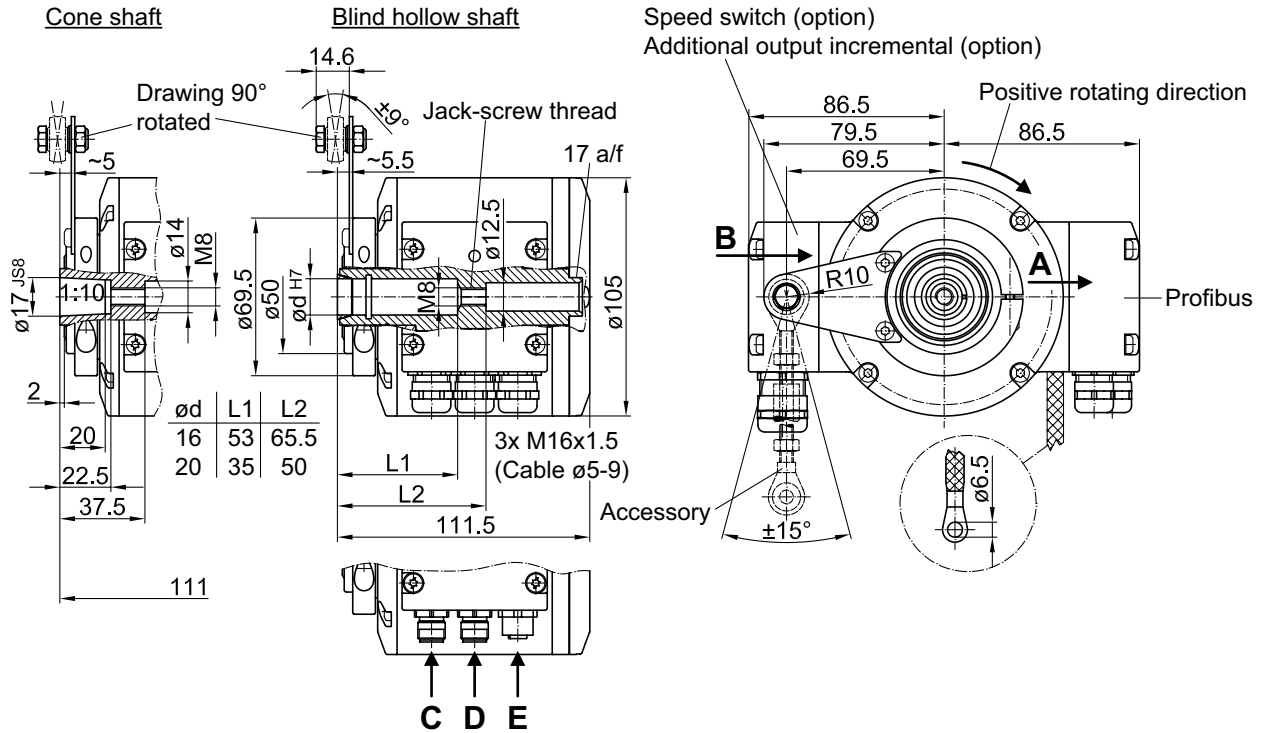

Through hollow shaft with radial terminal boxes

