

# Diffuse sensors with background suppression

## FHDK 04G6102/KS35A

### dimension drawing

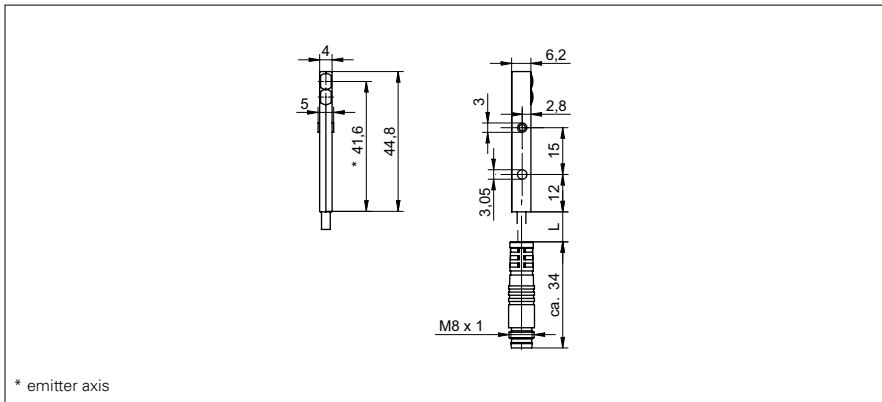

### general data

type	background suppression
light source	pulsed point source LED
sensing distance Tw	50 mm ±3 mm
alignment / soiled lens indicator	flashing light indicator
light indicator	LED yellow
wave length	660 nm
beam diameter	2 mm
suppression of reciprocal influence	yes

### electrical data

response time / release time	< 0,5 ms
voltage supply range +Vs	11 ... 30 VDC
current consumption max. (no load)	30 mA
current consumption typ.	20 mA
voltage drop Vd	< 2 VDC
output function	light operate
output circuit	push-pull
output current	< 50 mA
short circuit protection	yes
reverse polarity protection	yes, supply only

### mechanical data

width / diameter	4 mm
height / length	44,8 mm
depth	6,2 mm
type	rectangular
housing material	plastic (ASA)
front (optics)	PMMA
connection types	flylead connector M8 4 pin, L=200 mm

### ambient conditions

operating temperature	-10 ... +50 °C
protection class	IP 65

### photo



### connection diagram

