

Diffuse sensors with background suppression

FHDM 16N5001

dimension drawing

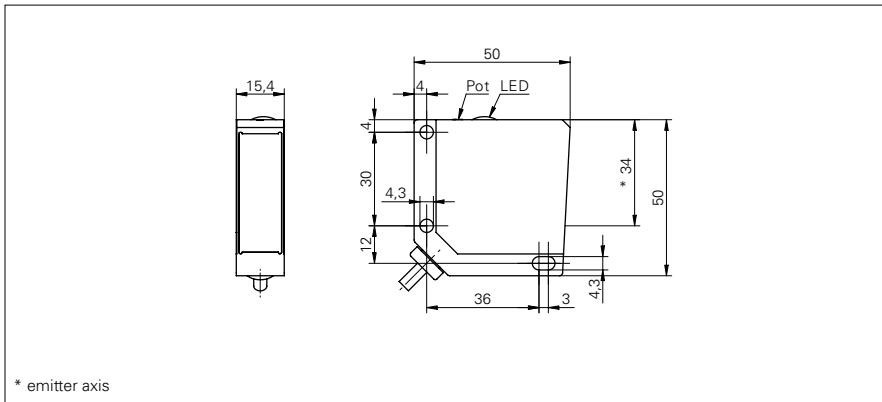

general data

type	background suppression
light source	pulsed red LED
sensing distance T_w	20 ... 450 mm
sensing range T_b (at T_w max.)	20 ... 450 mm
sensing range T_b (at T_w min.)	5 ... 20 mm
light indicator	LED yellow
sensing distance adjustment	mechanical, 5 turn
wave length	660 nm
suppression of reciprocal influence	yes

electrical data

response time / release time	< 1 ms
voltage supply range +Vs	10 ... 30 VDC
current consumption max. (no load)	41 mA
current consumption typ.	29 mA
voltage drop V_d	< 1,8 VDC
output function	light / dark operate
output circuit	NPN
output current	< 200 mA
short circuit protection	yes
reverse polarity protection	yes

mechanical data

width / diameter	15,4 mm
height / length	50 mm
depth	50 mm
type	rectangular
housing material	die-cast zinc
front (optics)	PMMA
connection types	cable 4 pin, 2 m

ambient conditions

operating temperature	-25 ... +65 °C
protection class	IP 67

photo



connection diagram

