

# Diffuse sensors with background suppression

## FHDM 16N5004/S14

### dimension drawing

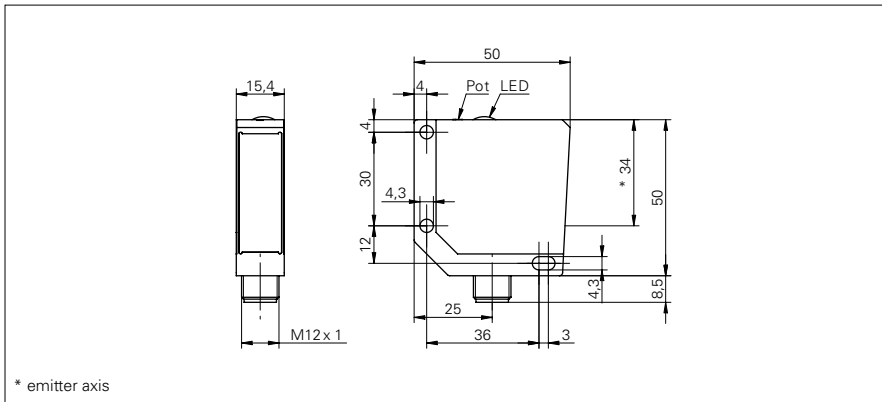

### general data

type	background suppression
light source	pulsed red LED
sensing distance $T_w$	20 ... 600 mm
sensing range $T_b$ (at $T_w$ max.)	20 ... 600 mm
sensing range $T_b$ (at $T_w$ min.)	5 ... 20 mm
light indicator	LED yellow
sensing distance adjustment	mechanical, 5 turn
wave length	660 nm
suppression of reciprocal influence	yes

### electrical data

response time / release time	< 5 ms
voltage supply range +Vs	10 ... 30 VDC
current consumption max. (no load)	41 mA
current consumption typ.	29 mA
voltage drop $V_d$	< 1,8 VDC
output function	light / dark operate
output circuit	NPN
output current	< 200 mA
short circuit protection	yes
reverse polarity protection	yes

### mechanical data

width / diameter	15,4 mm
height / length	50 mm
depth	50 mm
type	rectangular
housing material	die-cast zinc
front (optics)	PMMA
connection types	connector M12 4 pin

### ambient conditions

operating temperature	-25 ... +65 °C
protection class	IP 67

### photo



### connection diagram

