

Diffuse sensors with intensity difference

FZAM 08P1002/S35L

dimension drawing

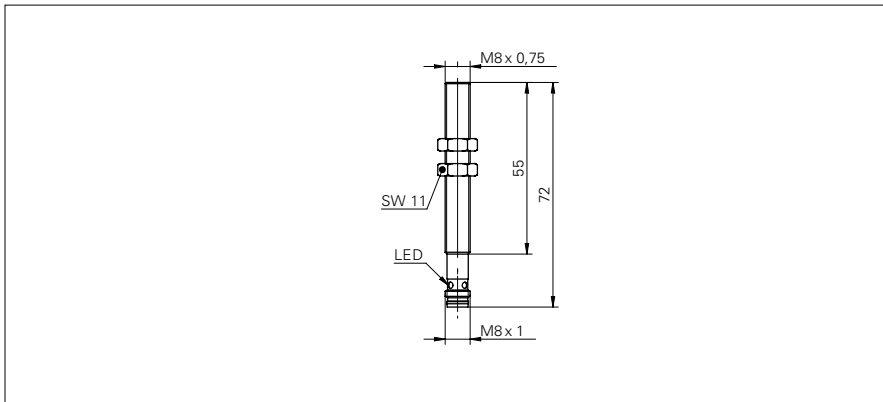

general data

type	intensity difference
light source	pulsed infrared diode
sensing distance Tw	< 80 mm
alignment / soiled lens indicator	flashing light indicator
light indicator	LED red
sensitivity adjustment	no
wave length	880 nm
suppression of reciprocal influence	yes

electrical data

response time / release time	< 1 ms
voltage supply range +Vs	10 ... 30 VDC
current consumption max. (no load)	42 mA
current consumption typ.	20 mA
voltage drop Vd	< 2 VDC
output function	light operate
output circuit	PNP
output current	< 100 mA
short circuit protection	yes
reverse polarity protection	yes

mechanical data

width / diameter	8 mm
height / length	73 mm
type	cylindrical threaded
housing material	brass nickel plated
front (optics)	PC
connection types	connector M8, 3 pin

ambient conditions

operating temperature	-25 ... +65 °C
protection class	IP 65

photo



connection diagram

