

Diffuse sensors with intensity difference

FZAM 30P5002

dimension drawing

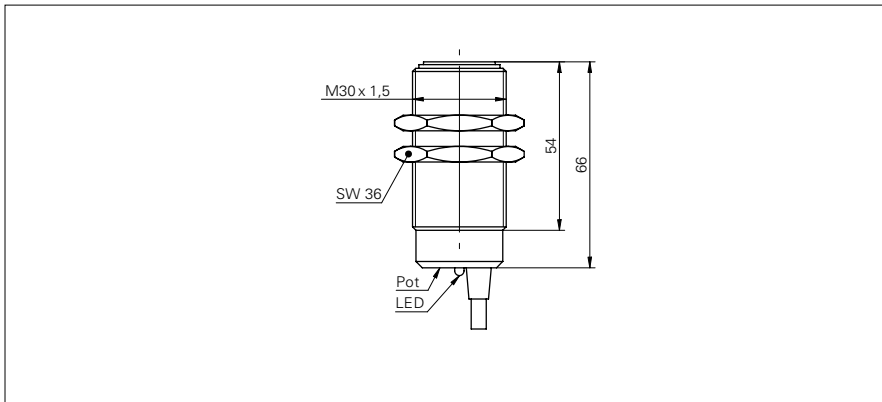

general data

type	intensity difference
light source	pulsed infrared diode
sensing distance Tw	300 ... 1500 mm
alignment / soiled lens indicator	flashing light indicator
light indicator	LED yellow
sensitivity adjustment	potentiometer, 15 turn
wave length	880 nm

electrical data

response time / release time	< 2,5 ms
voltage supply range +Vs	10 ... 30 VDC
current consumption max. (no load)	60 mA
current consumption typ.	50 mA
voltage drop Vd	< 2,5 VDC
output function	light / dark operate
output circuit	PNP
output current	< 100 mA
short circuit protection	yes
reverse polarity protection	yes

mechanical data

width / diameter	30 mm
height / length	66 mm
type	cylindrical threaded
housing material	brass nickel plated
front (optics)	PC
connection types	cable 4 pin, 2 m

ambient conditions

operating temperature	0 ... +65 °C
protection class	IP 65

photo



connection diagram

