

Inductive proximity switch

IFFM 08P37A5/O1S35L

dimension drawing

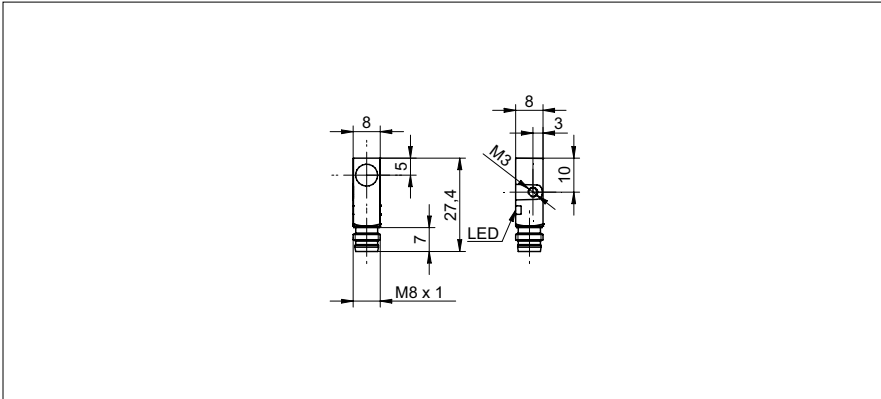

general data

mounting type	flush
nominal sensing distance S_n	2 mm
hysteresis	3 ... 20 % of S_r
output indicator	LED red

electrical data

switching frequency	< 5 kHz
voltage supply range +Vs	10 ... 30 VDC
current consumption max. (no load)	12 mA
output circuit	PNP break function (NC)
voltage drop V_d	< 2 VDC
output current	< 200 mA
short circuit protection	yes
reverse polarity protection	yes

mechanical data

type	rectangular
material (sensing face)	PBT
housing material	die-cast zinc nickel plated
dimension	8 mm
housing length	27,4 mm
connection types	connector M8

ambient conditions

operating temperature	-25 ... +75 °C
protection class	IP 67

photo



connection diagram

