

Inductive sensors special versions

IFRD 08N37A1/S35L

dimension drawing

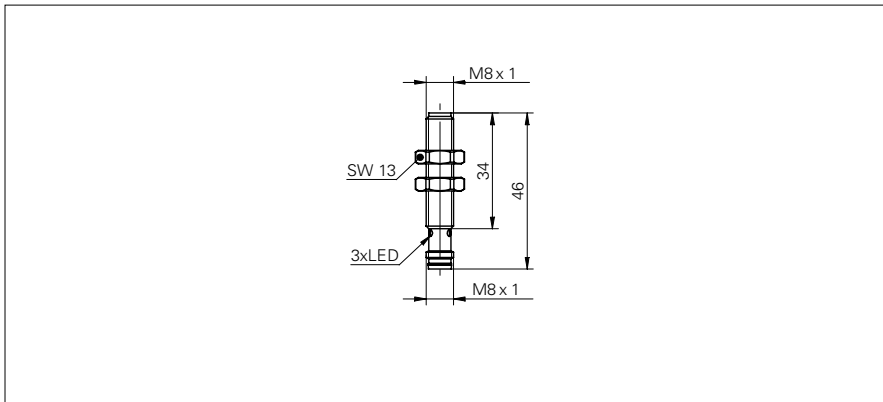

general data

mounting type	quasi-flush
special type	full metal housing (DuroProx)
nominal sensing distance S_n	2 mm
hysteresis	2 ... 20 % of S_r
output indicator	3 port LED red

electrical data

switching frequency	< 150 Hz
voltage supply range +Vs	10 ... 30 VDC
current consumption max. (no load)	20 mA
output circuit	NPN break function (NC)
voltage drop V_d	< 2 VDC
output current	< 200 mA
short circuit protection	yes
reverse polarity protection	yes

mechanical data

type	cylindrical threaded
material (sensing face)	stainless steel 1.4404 (V4A)
housing material	stainless steel 1.4404 (V4A)
pressure static	< 20 bar
dimension	8 mm
housing length	46 mm
connection types	connector M8

ambient conditions

operating temperature	-25 ... +75 °C
protection class	IP 68/67 (sensing face/sensor)

photo



connection diagram



- Higher noise immunity (EMC), (EN 61000-6-2)