

Inductive proximity switch

IFRM 05N17A1/S35L

dimension drawing

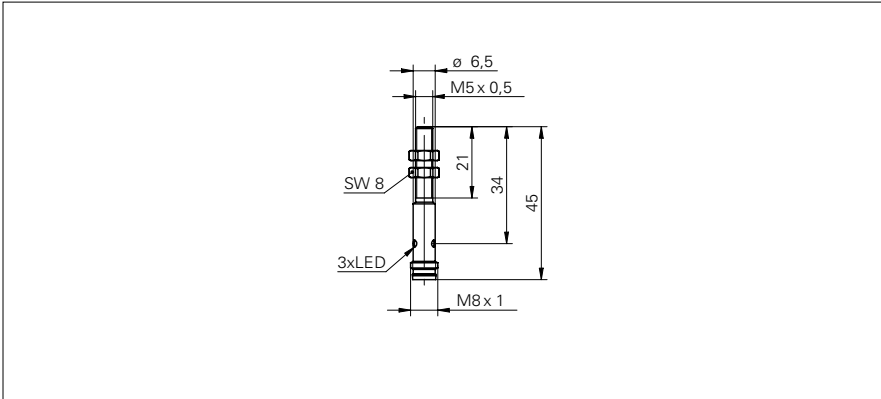

general data

mounting type	flush
nominal sensing distance S_n	1,6 mm
hysteresis	2 ... 20 % of S_r
output indicator	3 port LED red

electrical data

switching frequency	< 3 kHz
voltage supply range +Vs	10 ... 30 VDC
current consumption max. (no load)	12 mA
output circuit	NPN make function (NO)
voltage drop V_d	< 2 VDC
output current	< 100 mA
short circuit protection	yes
reverse polarity protection	yes

mechanical data

type	cylindrical threaded
material (sensing face)	LCP
housing material	stainless steel
dimension	5 mm
housing length	45 mm
connection types	connector M8

ambient conditions

operating temperature	-25 ... +75 °C
protection class	IP 67

photo



connection diagram



- M8 x 1 quick disconnect
- 3 port LED