

**Inductive proximity switch**

**IFRM 06P37A3/S35L**

**dimension drawing**

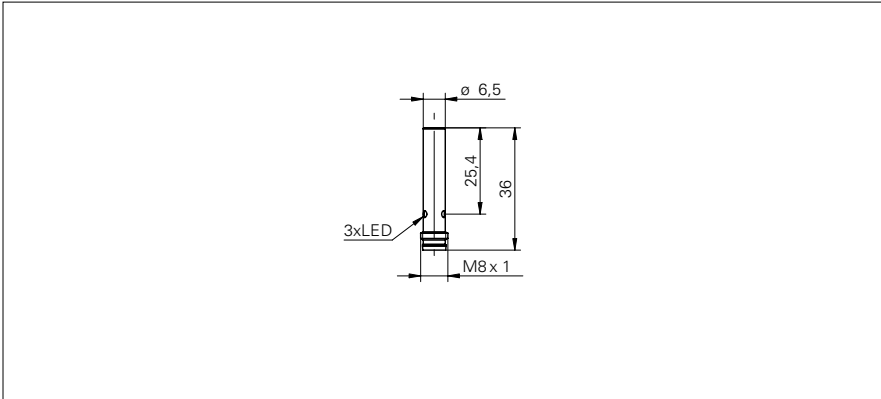

**general data**

mounting type	flush
nominal sensing distance $S_n$	2 mm
hysteresis	3 ... 20 % of $S_r$
output indicator	3 port LED red

**electrical data**

switching frequency	< 5 kHz
voltage supply range +Vs	10 ... 30 VDC
current consumption max. (no load)	12 mA
output circuit	PNP break function (NC)
voltage drop $V_d$	< 2 VDC
output current	< 200 mA
short circuit protection	yes
reverse polarity protection	yes

**mechanical data**

type	cylindrical smooth
material (sensing face)	PBT
housing material	stainless steel
dimension	6,5 mm
housing length	36 mm
connection types	connector M8

**ambient conditions**

operating temperature	-25 ... +75 °C
protection class	IP 67

**photo**



**connection diagram**



- robust steel housings
- high switching frequency