

Inductive sensors NAMUR

IFRM 08X9103

dimension drawing

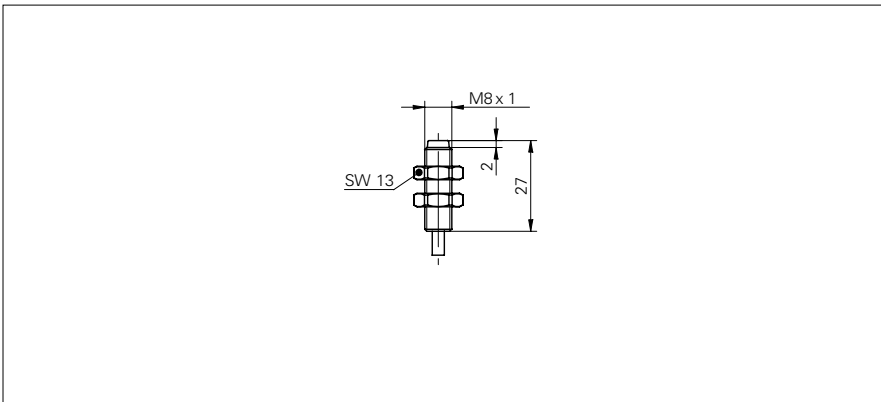

general data

mounting type	non-flush
nominal sensing distance S_n	2 mm
approvals/certificates	ATEX 1G

electrical data

switching frequency	< 5 kHz
normal operating voltage	8,2 VDC
voltage supply range +Vs	5 ... 30 VDC
current consumption undamped	> 4 mA
current consumption damped	< 1 mA
current consumption max. (no load)	10 mA
output circuit	NAMUR
residual ripple	< 10 % Vs

mechanical data

type	cylindrical threaded
housing material	brass nickel plated
dimension	8 mm
housing length	27 mm
connection types	cable, 2 m

ambient conditions

operating temperature	-25 ... +75 °C
protection class	IP 67

safe maximum values

EC-type-examination Certificate	PTB 03 ATEX 2146
marking	II 1G Ex ia IIC T6 Ga
current I_i	< 37 mA
voltage U_i	< 13,5 VDC
power P_i	< 0,125 W
internal capacitance C_i	< 50 nF
internal inductance L_i	< 0,2 mH
operating temperature T_a (temp. class T5)	-20 ... +60 °C
operating temperature T_a (temp. class T6)	-20 ... +40 °C

photo



connection diagram

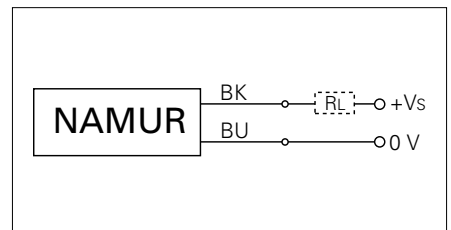

• connector base version /S35