

Inductive proximity switch

IFRM 18P37A3/L

dimension drawing

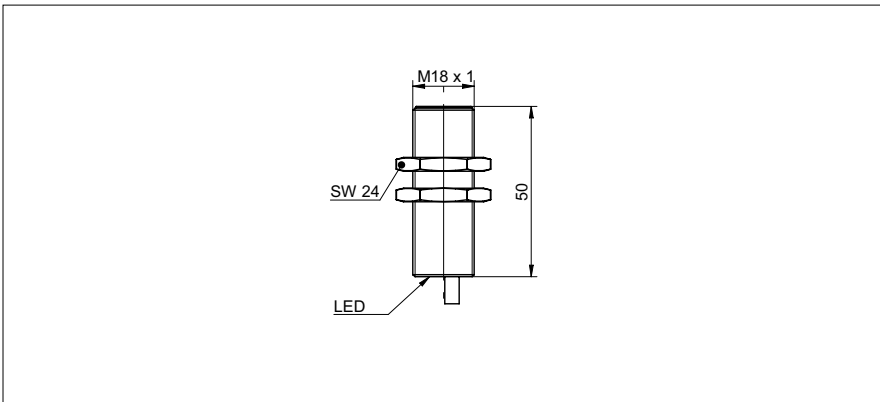

general data

mounting type	quasi-flush
nominal sensing distance S_n	8 mm
hysteresis	3 ... 20 % of S_r
output indicator	LED red

electrical data

switching frequency	< 500 Hz
voltage supply range +Vs	10 ... 30 VDC
current consumption max. (no load)	10 mA
output circuit	PNP break function (NC)
voltage drop V_d	< 2 VDC
output current	< 200 mA
short circuit protection	yes
reverse polarity protection	yes

mechanical data

type	cylindrical threaded
material (sensing face)	PBT
housing material	brass nickel plated
dimension	18 mm
housing length	50 mm
connection types	cable, 2 m
tightening torque max.	40 Nm

ambient conditions

operating temperature	-25 ... +75 °C
protection class	IP 67

photo



connection diagram

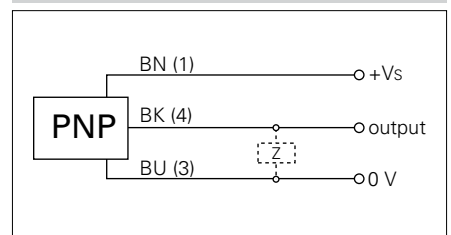

• Not for flush mounting in mild steel