

Inductive sensors special versions

IFRP 18P1501/S14

dimension drawing

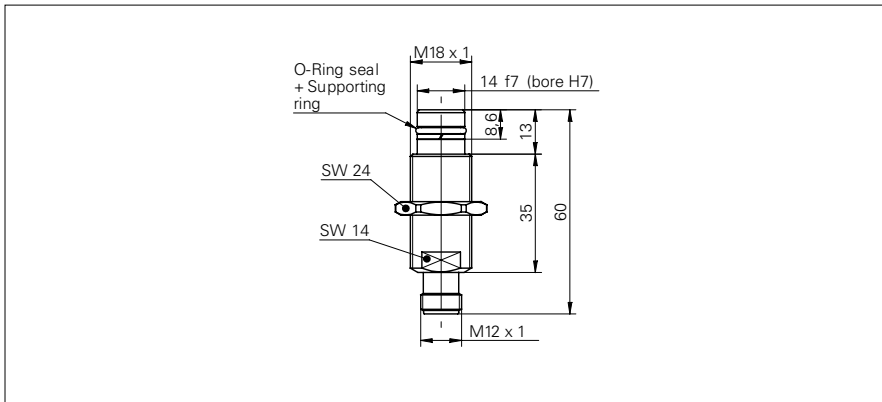

general data

mounting type	flush
special type	high pressure
nominal sensing distance S_n	2 mm
hysteresis	2 ... 20 % of S_n

electrical data

switching frequency	< 3 kHz
voltage supply range +Vs	10 ... 30 VDC
current consumption max. (no load)	12 mA
output circuit	PNP make function (NO)
voltage drop V_d	< 2 VDC
output current	< 200 mA
short circuit protection	yes
reverse polarity protection	yes

mechanical data

type	cylindrical threaded
material (sensing face)	ceramic
housing material	stainless steel
pressure static	< 500 bar
pressure dynamic	< 350 bar
dimension	18 mm
housing length	60 mm
connection types	connector M12

ambient conditions

operating temperature	-25 ... +80 °C
protection class	IP 68/67 (sensing face/sensor)

photo



connection diagram

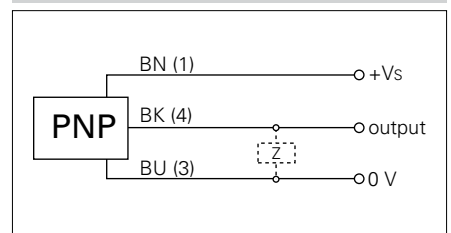

installation drawing

