

Inductive proximity switch

IFRR 08P33T1/S14L-9

dimension drawing

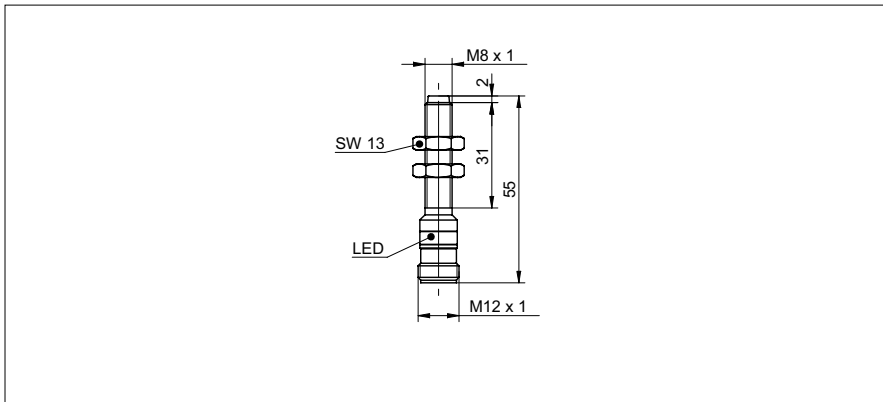

general data

mounting type	non-flush
special type	Outdoor design Washdown design
nominal sensing distance S_n	3 mm
hysteresis	2 ... 15 % of S_r
output indicator	LED red
approvals/certificates	Ecolab

electrical data

switching frequency	< 3 kHz
voltage supply range +Vs	10 ... 30 VDC
current consumption max. (no load)	10 mA
output circuit	PNP break function (NC)
voltage drop V_d	< 2 VDC
output current	< 200 mA
output current (at cleaning temperature)	< 100 mA
short circuit protection	yes
reverse polarity protection	yes

mechanical data

type	cylindrical threaded
material (sensing face)	LCP
housing material	stainless steel 1.4404 (V4A); LSR
dimension	8 mm
housing length	55 mm
connection types	connector M12

ambient conditions

operating temperature	-40 ... +80 °C
cleaning temperature	80 ... +100 °C (30 min/day)
protection class	IP 68/69K & proTect+
vibration resistance	EN 61373: 2010 (category 3), 5h per axis (14.4 gRMS, 10-500 Hz, EN 60068-2-64)
shock resistance	EN 61373: 2010 (category 3), 10 bumps per axis (100 g, 6 ms, EN 60068-2-27)

photo



connection diagram



- Sensor FDA compliant and Ecolab approved
- LSR = Liquid Silicon Rubber