

# Inductive distance measuring sensors

## IWRM 30U9502

### dimension drawing

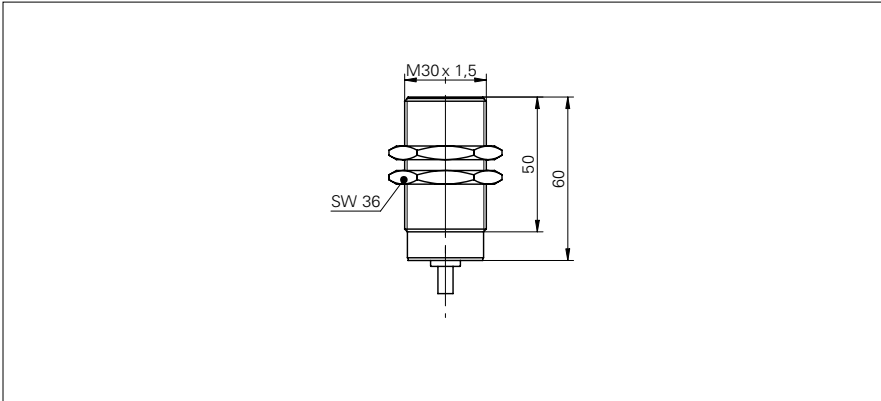

### general data

mounting type	flush
measuring distance Sd	5 ... 9 mm
reference distance	6,7 ... 7,3 mm
measuring speed	< 1,5 mm / ms
repeat accuracy	< 0,02 mm
linearity error	± 150 µm
temperature coefficient	1 µm / (K mm)

### electrical data

voltage supply range +Vs	15 ... 30 VDC
current consumption max. (no load)	20 mA
output circuit	voltage output
output signal	1 ... 9 VDC
load resistance	> 1000 Ohm
residual output ripple	< 0,5 % Vs
short circuit protection	yes
reverse polarity protection	yes

### mechanical data

type	cylindrical threaded
housing material	brass nickel plated
dimension	30 mm
housing length	60 mm
connection types	cable, 2 m

### ambient conditions

operating temperature	0 ... +60 °C
protection class	IP 67

### photo



### connection diagram

