

My-Com precision switches

MY-COM A50/S35

dimension drawing

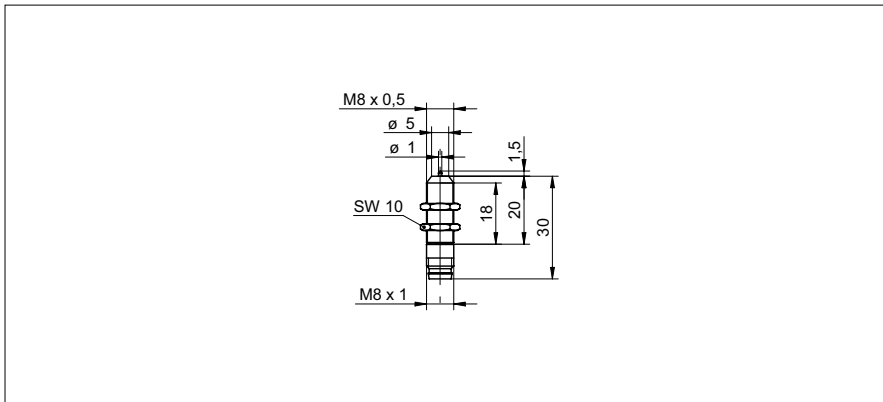

general data

repeat accuracy	< 0,001 mm
activating force	50 cN
mech. pre-run / overrun	- / 1,5 mm approx.
measurement type	contact with medium
direction of approach	frontal

electrical data

DC voltage max.	15 VDC
switch. current DC max.	2 mA
AC voltage max.	24 VAC
switch. current AC max.	50 mA
output circuit	break function (NC) mechanical

mechanical data

activating pin	zirconium oxide ZrO2
housing material	brass nickel plated
dimension	8 mm
type	cylindrical threaded
housing length	30 mm
connection types	connector M8

ambient conditions

operating temperature	-20 ... +75 °C
protection class	IP 50

photo



connection diagram

