

**Through beam sensors**

**O300W.TR-11167300**

**dimension drawing**

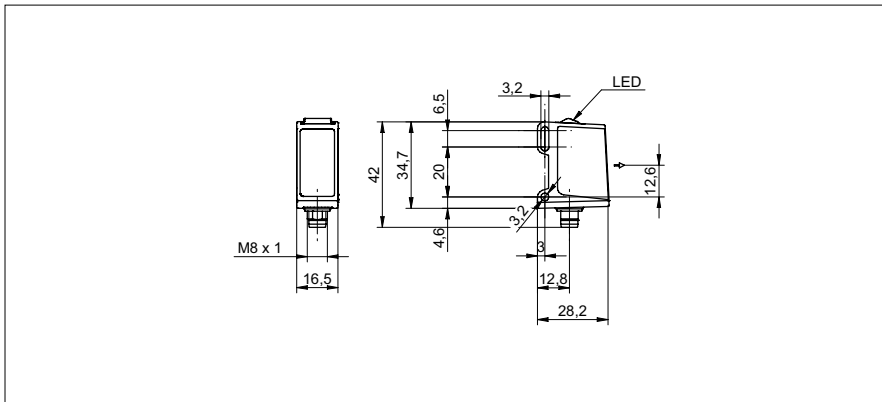

**general data**

type	through beam sensor
special type	Washdown design
emitter / receiver	emitter
light source	pulsed red LED
actual range Sb	10 m
nominal range Sn	15 m
power on indication	LED green
wave length	645 nm
alignment optical axis	< 2°
approvals/certificates	Ecolab

**electrical data**

response time / release time	< 0,49 ms
voltage supply range +Vs	10 ... 30 VDC
current consumption max. (no load)	40 mA
current consumption typ.	30 mA
reverse polarity protection	yes

**mechanical data**

width / diameter	16,5 mm
height / length	34,7 mm
depth	28,2 mm
type	rectangular
housing material	stainless steel 1.4404 (V4A)
front (optics)	PMMA
connection types	connector M8 4 pin

**ambient conditions**

operating temperature	-25 ... +60 °C
protection class	IP 68/69K & proTect+

**photo**



**connection diagram**

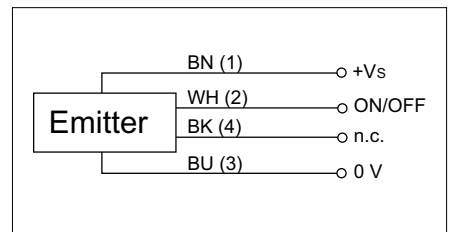

proTect<sup>+</sup>

