

Ultrasonic proximity sensors

UNDK 30N1712/S14

dimension drawing

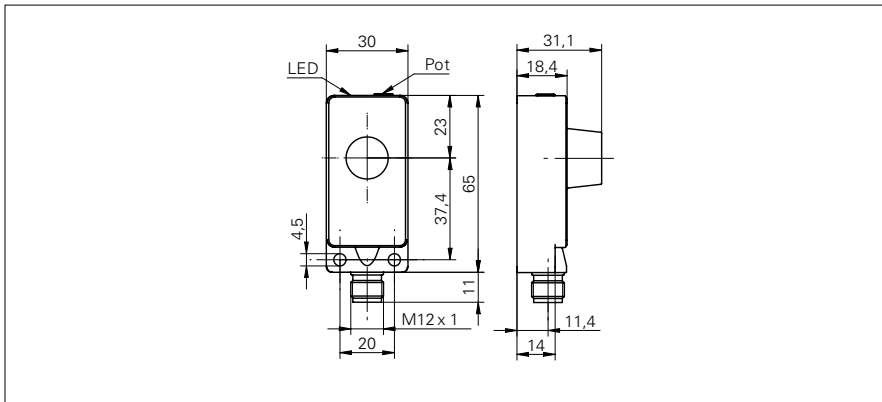

general data

scanning range sd	60 ... 400 mm
scanning range far limit Sde	60 ... 400 mm
hysteresis typ.	4 % Sde
repeat accuracy	< 0,5 mm
synchronization	yes
multiplex version	on request
temperature drift	< 0,18 % Sde/K
response time ton (sync on)	< 25 ms
release time toff (sync on)	< 25 ms
sonic frequency	400 kHz
adjustment	potentiometer
alignment aid	target indication flashing
output indicator	LED green

photo



electrical data

voltage supply range +Vs	12 ... 30 VDC
current consumption max. (no load)	35 mA
output circuit	NPN make function (NO)
output current	< 200 mA
voltage drop Vd	< 2 VDC
residual ripple	< 10 % Vs
short circuit protection	yes
reverse polarity protection	yes

connection diagram

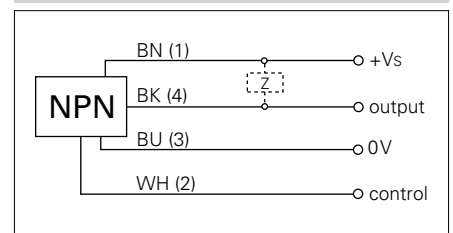

mechanical data

type	rectangular
housing material	polyester / die-cast zinc
width / diameter	30 mm
height / length	65 mm
depth	31 mm
connection types	connector M12

ambient conditions

operating temperature	-25 ... +60 °C
protection class	IP 67



• with synchronization output