

Ultrasonic retro-reflective sensors

URDK 20N6914/S35A

dimension drawing

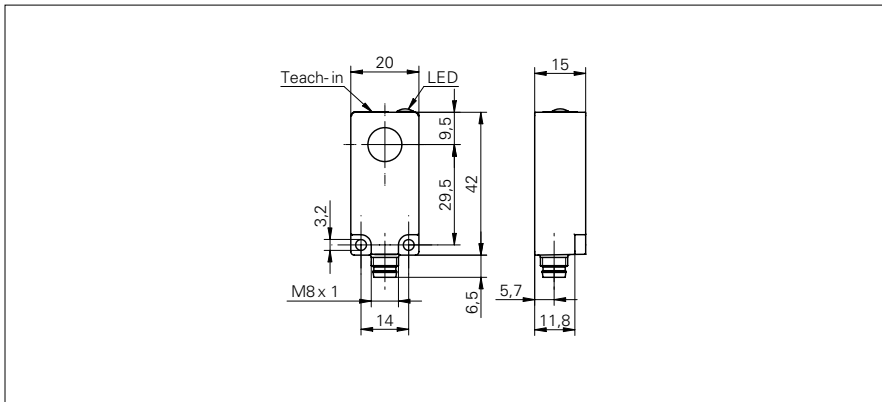

general data

| | |
|---|----------------------------|
| scanning range sd | 0 ... 200 mm |
| reflector position Sde | 40 ... 200 mm |
| adjusting range reflector (operating range) | ± 2,5 % Sde |
| adjusting range reflector (limit range) | ± 5 % Sde |
| repeat accuracy | < 1,5 mm |
| temperature drift | < 2 % Sde |
| response time ton | < 10 ms |
| release time toff | < 10 ms |
| sonic frequency | 380 kHz |
| adjustment | Teach-in |
| alignment aid | target indication flashing |
| output indicator | LED green |

electrical data

| | |
|------------------------------------|------------------------|
| voltage supply range +Vs | 12 ... 30 VDC |
| current consumption max. (no load) | 35 mA |
| output circuit | NPN make function (NO) |
| output current | < 200 mA |
| voltage drop Vd | < 2 VDC |
| residual ripple | < 10 % Vs |
| short circuit protection | yes |
| reverse polarity protection | yes |

mechanical data

| | |
|------------------|--------------|
| type | rectangular |
| housing material | polyester |
| width / diameter | 20 mm |
| height / length | 42 mm |
| depth | 15 mm |
| connection types | connector M8 |

ambient conditions

| | |
|-----------------------|----------------|
| operating temperature | -10 ... +60 °C |
| protection class | IP 67 |

photo



connection diagram

