

# SAFETY ACCESS CONTROL BARRIER



**YCA-50 □4-3500-□□□□**



**3 BEAMS / BEAM GAP 500 MM**

**TYPE 4 / PL e**

## MAIN FEATURES

- Protective height: 1032 mm
- Operating range: 1 ... 15 m / 10 ... 50 m
- Category 4, PL e according to ISO 13849-1 (former EN 954-1)
- Type 4 according to IEC 61496-1/2
- 2-channel selection
- Optically synchronized units
- Permanent autocontrol

## TECHNICAL DATA (at +23 °C ±5 °C, 24 VDC)

Number of beams	3
Beam gap (Bg)	500 mm
Effective aperture angle	< ± 2.5° (when operating distance ≥ 3 m)
Operating range	1 ... 15 m / 10 ... 50 m (can be configured)
Dimensions	42 mm x 48 mm x Ht (total height with M12 connector)
Total height (Ht)	1154 mm
Housing height (Hb)	1124 mm
Protective height (Hs)	1032 mm
Height extension (He)	21 mm
Response time	4.2 ms
Supply voltage range	24 VDC ± 15 %
Current consumption	sender: 35 mA max. / receiver: 75 mA max. (excl. load)
Dissipated power	sender: 1.0 W max. / receiver: 2.2 W max. (excl. load)
Output type	2 PNP outputs
Output protection	short-circuit, overload protected
Output monitoring	cross-circuit monitored
Load current	max. 200 mA per output (at 50 °C / 122 °F)
Output voltage ON min.	-1.0 V of the operating voltage
Output voltage OFF max.	1.0 V
Output monitoring frequency	500 Hz
Leakage current when OFF state	< 1 mA
Maximum load inductance	100 mH
Sender wavelength	IR 880 nm
Safety level	Category 4, Type 4 (IEC 61496-1/2) PL e, MTTF <sub>d</sub> = 112 years, DC <sub>avg</sub> = 97% (EN/ISO 13849-1)
Electrical protection class	III (IEC 61140)
Startup delay	< 0.5 s
Vibration resistance	10 to 55 Hz, 0.35 mm amplitude, 1 octave/min., 20 sweeps for each axis
Shock resistance	10 g during 16 ms, 1000 times for each axis
Light immunity	incandescent lamp: 3000 lx max. (light intensity on receiver surface) xenon flash tube: flash duration 1.2 ms max. with a frequency of 2 Hz max. (TS 61496-2)
Ambient temperature range	-35 ... +60 °C (-31 ... +140 °F)
Storage temperature range	-40 ... +70 °C (-40 ... +158 °F)
Air humidity	15 ... 95 % (non-condensing)
Degree of protection	IP 65 + IP 67 (EN 60529/A1)
Housing material	aluminum profile, PMMA front screen
Material of upper and lower cover	PA + 30% fiberglass
Cable runs	10 m max. (at 10 nF capacitive load)
Weight	2410 g per unit (with M12 connector)
Reference standards:	safety IEC 61496-1, IEC 61496-2, EN 60204-1, EN 50178
	environment EN 60068-2-1,2,3,6,29
	EMC EN 61000-4-2,3,4,5,6,11
	radio disturbance EN 55011/A2

**DIMENSIONS**

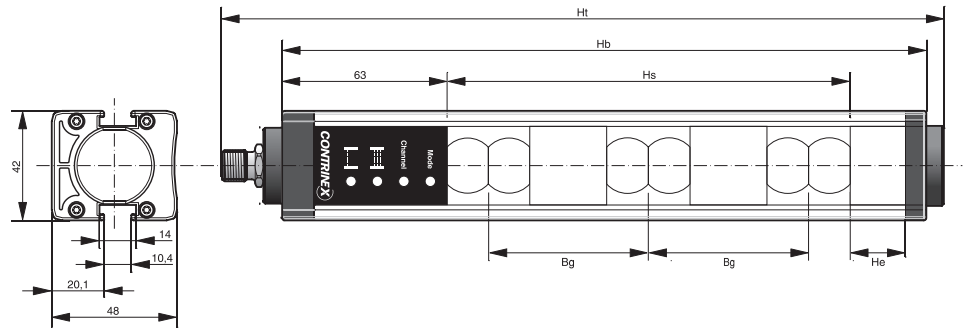

**M12 connector**  
YCA-50S4-3500-G012  
YCA-50R4-3500-G012

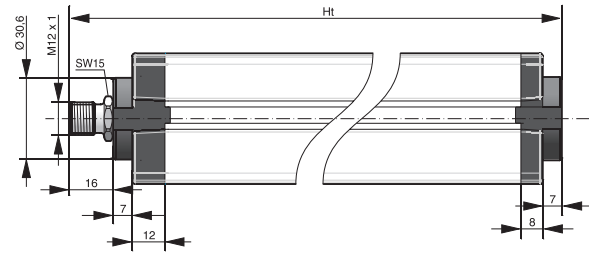

**M26 connector**  
YCA-50S4-3500-G026  
YCA-50R4-3500-G026

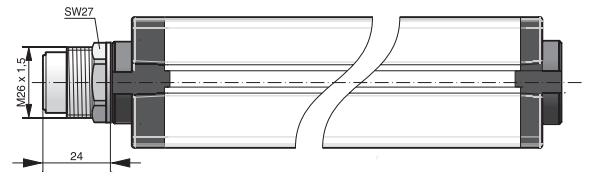

**Pigtail M12**  
YCA-50S4-3500-P012  
YCA-50R4-3500-P012

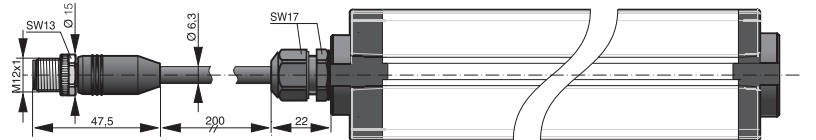

**Cable**  
YCA-50S4-3500-D...  
YCA-50R4-3500-D...

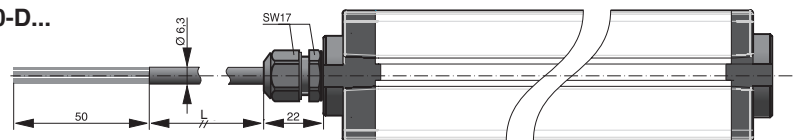

**PART REFERENCE**

Output / Connection	Sender	Receiver
PNP / Connector M12	YCA-50S4-3500-G012	YCA-50R4-3500-G012
PNP / Connector M26	YCA-50S4-3500-G026	YCA-50R4-3500-G026
PNP / Pigtail M12	YCA-50S4-3500-P012	YCA-50R4-3500-P012
PNP / PUR cable 2 m	YCA-50S4-3500-D020	YCA-50R4-3500-D020
PNP / PUR cable 5 m	YCA-50S4-3500-D050	YCA-50R4-3500-D050
PNP / PUR cable 10 m	YCA-50S4-3500-D100	YCA-50R4-3500-D100

### LED INDICATORS

LED indicators on the YCA **sender** unit

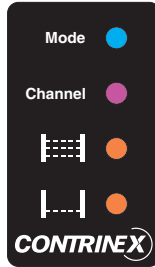

- Operating range: OFF when max. operating range = 15 m  
blue when max. operating range = 50 m  
red or purple in case of wiring error
- Channel : blue when channel 1 selected  
purple when channel 2 selected
- Alignment : steady orange when screen not fully aligned  
flashing orange when first third of screen aligned  
OFF when screen fully aligned
- Alignment : steady orange when lowest beam not aligned  
flashing orange when lowest beam aligned  
OFF when screen fully aligned

LED indicators on the YCA **receiver** unit

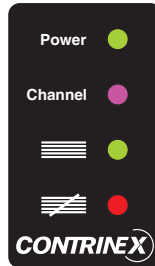

- Power : green when power ON
- Channel : blue when channel 1 selected  
purple when channel 2 selected
- Status : green when OSSD outputs ON
- Status : red when OSSD outputs OFF

### PIN ASSIGNMENT

**M12 connector**

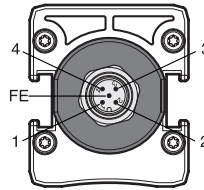

**M26 connector**

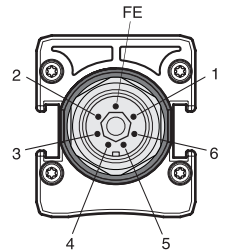

**Pigtail M12**



**cable**

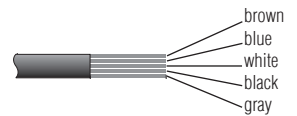

ASSIGNMENT	FUNCTION	PINS/WIRES ON SENDER			PINS/WIRES ON RECEIVER		
		M12 / PIGTAIL	M26	OPEN CABLE	M12 / PIGTAIL	M26	OPEN CABLE
Power supply	24 VDC for channel 1 0 V for channel 2	1	1	brown	1	1	brown
Power supply	0 V for channel 1 24 VDC for channel 2	3	2	blue	3	2	blue
Operating range selection	24 VDC for 10...50 m 0 V for 1...15 m	4	3	black	-	-	-
Operating range selection	0 V for 10...50 m 24 VDC for 1...15 m	2	4	white	-	-	-
Output	OSSD1	-	-	-	2	4	white
Output	OSSD2	-	-	-	4	3	black
Functional earth	Shield	FE	FE	gray	FE	FE	gray