

FBE 60 Cleaning Air Nozzle

- For cleaning the receiver optics from accumulations and dirt
- By means of an M5 tube-adaption easy pneumatic connection
- Flexible
- Length 60 mm

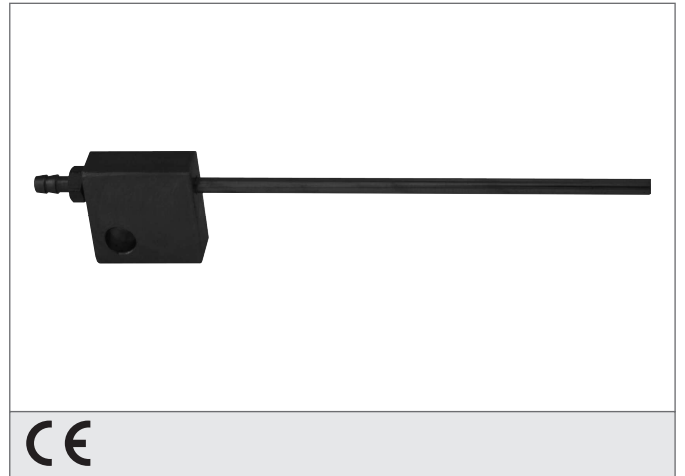

Safety instructions

The Instruments are not to be used for safety applications, in particular applications in which safety of persons depends on proper operation of the instruments.
These instruments shall exclusively be used by qualified personnel.

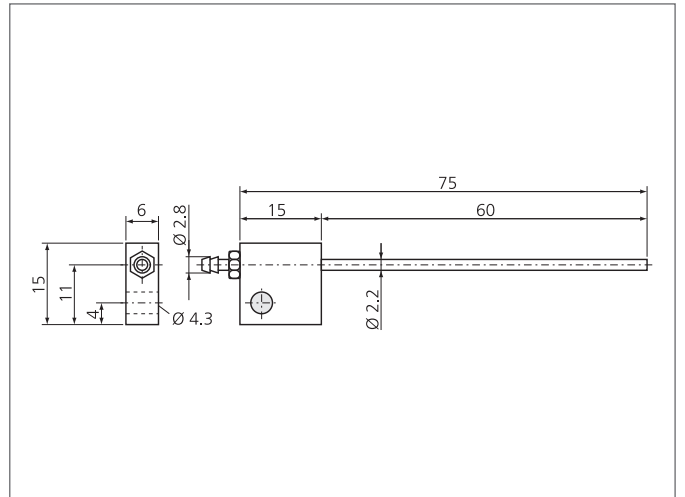

TECHNICAL INFORMATION (typ.)

Length	60 mm
Characteristics	Flexible, for angled and fork light barriers
Casing material	metal