

OTV 22 K 115 P1K

Diffuse Sensor

- Compact design
- Red light
- Sensitivity adjustable
- High resolution, operating frequency

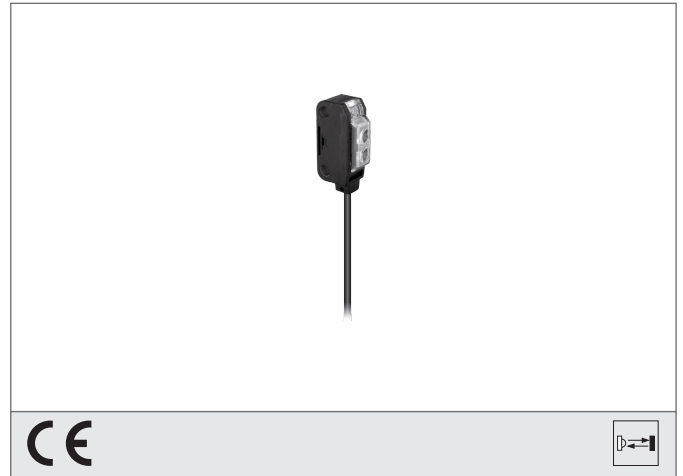

Safety instructions

The Instruments are not to be used for safety applications, in particular applications in which safety of persons depends on proper operation of the instruments.

These instruments shall exclusively be used by qualified personnel.

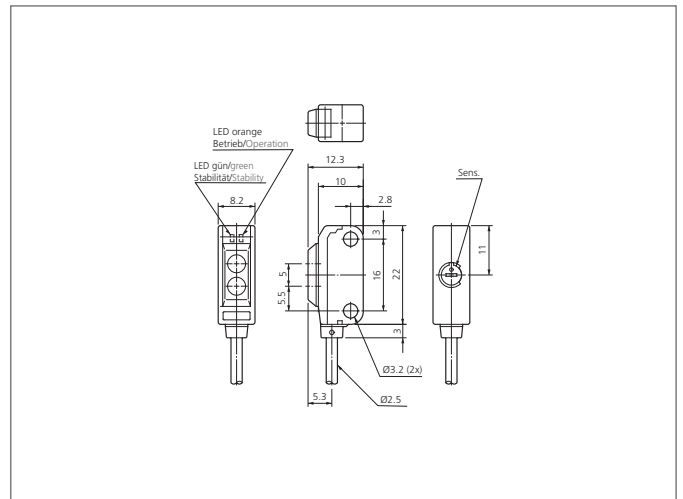

TECHNICAL INFORMATION (typ.)		+20°C, 24V DC
Operating principle		Diffuse reflective sensor
Evaluation		digital
Size		22 x 10 x 8 mm (Dimensions)
Design		cuboid design
Emitted light		Red, 680 nm, clocked
Standardized measuring plate		100 x 100 mm, white
Service voltage		12 ... 24 V DC
Internal power consumption		< 20 mA
background suppression		no
Operating distance		90 ... 115 mm
Sensitivity adjustment		potentiometer
Switching output		pnp, 50 mA, NO
Switching hysteresis		< 15 %
Switching frequency		1.000 Hz
Response-/release time		< 0,5 ms / < 0,5 ms
Ambient temperature		-25 ... +55 °C
Temperature drift		0,3 %/K
Ambient light immunity		3 kLx
Insulation voltage endurance		1.000 V
Protection class		IP 67
Protection degree		III, operation on protective low voltage
Casing material		plastics
Material		plastic (Window)

OTV 22 K 115 P1K
Diffuse Sensor



TECHNICAL INFORMATION (typ.)

Connection

+20°C, 24V DC

cable PVC, 2 m