

TKHM-W-5/4 Connecting Cable

- Drag chain compatible
- Sturdy metal coupling ring
- Durable PU coating
- Flexible lead design
- Good stripping properties
- High protection class
- Gold-plated plug-in contacts

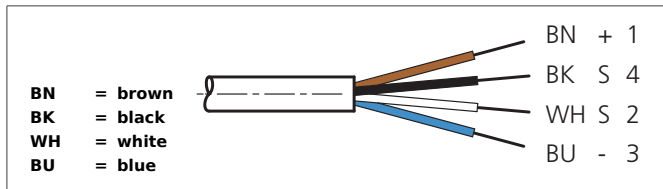

CE



Safety instructions

The Instruments are not to be used for safety applications, in particular applications in which safety of persons depends on proper operation of the instruments.

These instruments shall exclusively be used by qualified personnel.

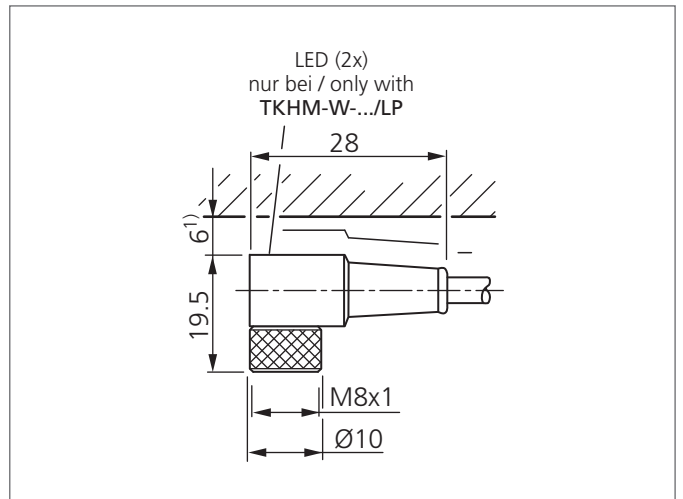

TECHNICAL INFORMATION (typ.)		+20°C, 24V DC
Size		Ø 4.8 mm (Diameter) M8 x 1 (thread)
Design		angled
Length		5.000 mm
Characteristics		metal coupling ring
Service voltage		< 60 V AC/DC
LED indicator		no
Ambient temperature		-30 ... +80°C (fixed), -5 ... +80°C (moved)
Protection class		IP 67, (at tightening torque 0,4 Nm)
Material		PUR (Cable) PUR (connector)
Connection		Connector, M8, 4-poled
Drag chain compatible		Yes
Drag chain properties		2 Mio. (Bending cycles) 70 mm (Minimum bending radius)