

# LGL 051 N3K-TSSL

## Laser Angled Light Barrier

- Very high resolution
- Mountable side by side
- Optical axis approachable in x-, y- and z-direction
- Visible laser spot
- High operating frequency
- Light/dark switching
- Laser class 1
- Bright ring LED
- 5-year warranty



### Safety instructions

Inproper use may result in hazardous radiation exposure. Pay attention to accident prevention rules and laser class. The instruments are not to be used for safety applications, in particular applications in which safety of persons depends on proper operation of the instruments. These instruments shall exclusively be used by qualified personnel.

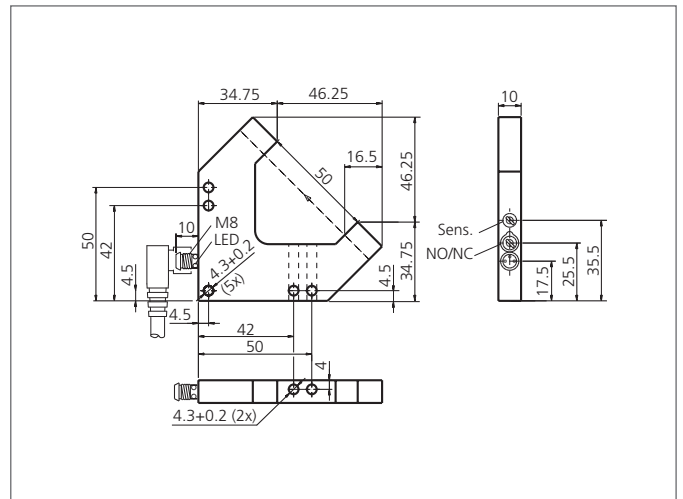

TECHNICAL INFORMATION (typ.)		+20°C, 24V DC
Operating principle		Optical
Evaluation		digital
Size		81 x 81 x 10 mm (Dimensions)
Design		Angle
Branch length		50/50 mm
Emitted light		Red light laser, 650 nm, clocked
Laser class		1 (IEC 60825-1)
Service voltage		10 ... 35 V DC (Supply Class 2)
Internal power consumption		< 30 mA
Operating distance		50 mm (optical axis)
Resolution		50 µm
Sensitivity adjustment		potentiometer
Switching output		npn, 200 mA, NO/NC, switchable
Switching hysteresis		< 20 µm
Voltage drop		< 2,8 V
Switching frequency		3.000 Hz
Reproducibility		10 µm
Laser power		< 100 µW
Ambient temperature		+5 ... +45 °C
Ambient light immunity		100 kLx
Insulation voltage endurance		250 V
Protection class		IP 67
Protection degree		III, operation on protective low voltage

# LGL 051 N3K-TSSL

## Laser Angled Light Barrier



### TECHNICAL INFORMATION (typ.)

**+20°C, 24V DC**

Casing material	Aluminium black anodized
Connection	Connector, M8, 3-poled
Connecting cable	TK ...