

MZ-S-10/6.5 Sensor clamp

- Reliable mounting of cylinder sensors at round cylinders
- High locking power
- Robust casing
- For a quick and easy fix and mounting of sensors

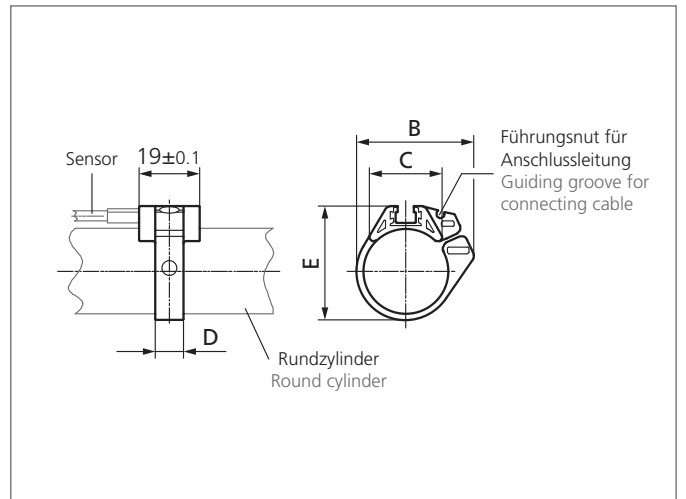
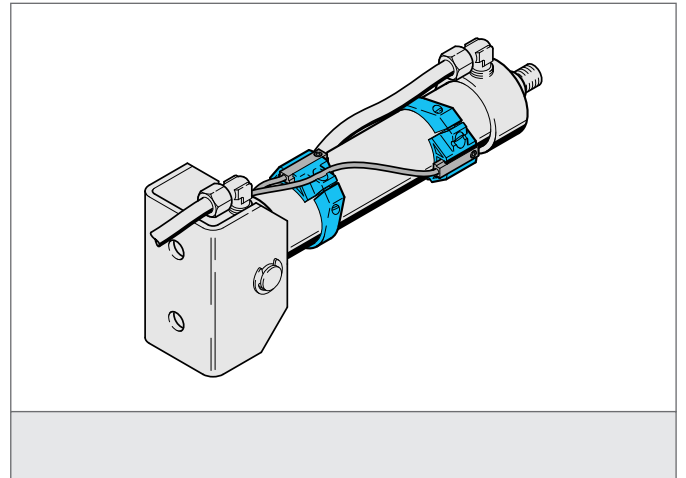

TECHNICAL INFORMATION (typ.)

Size	20.4 mm (Spacer measure B) 13.7 mm (Spacer measure C) 7 mm (Spacer measure C) 19.9 mm (Spacer measure E)
Mounting	at round cylinders
For	Cylinder sensores with T-Slot
Casing material	Aluminium / ring POM, (polyacetal - POM)
to be used for	Cylinder Ø 10 mm
Scope of delivery	Fixing material