

MZ-S-25/6.5 Sensor clamp

- Reliable mounting of cylinder sensors at round cylinders
- High locking power
- Robust casing
- For a quick and easy fix and mounting of sensors

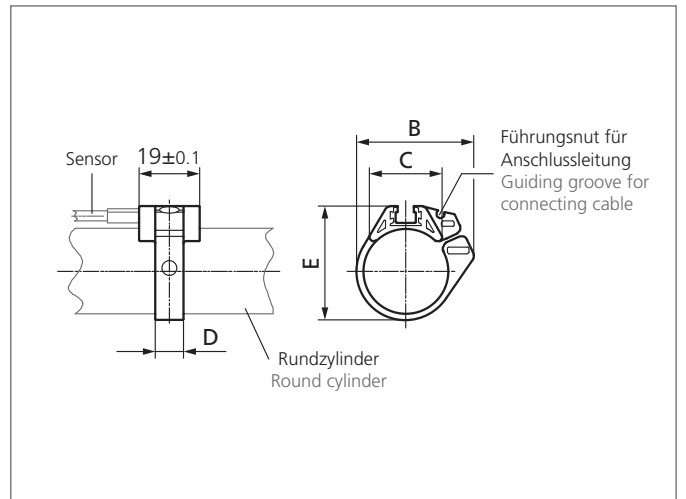
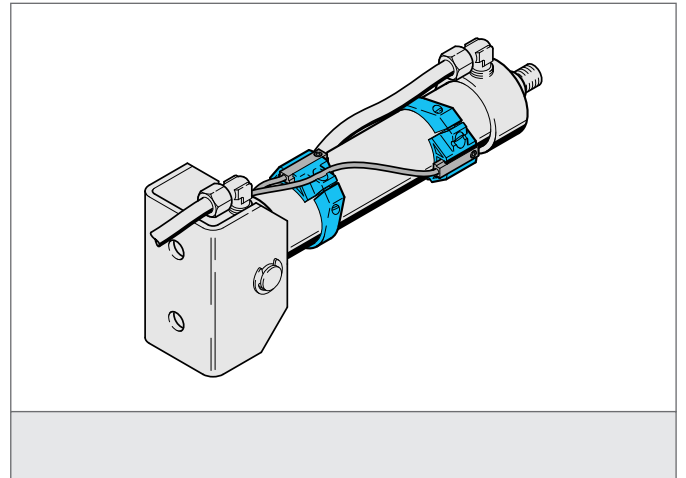

TECHNICAL INFORMATION (typ.)

Size	36.5 mm (Spacer measure B) 22.6 mm (Spacer measure C) 9 mm (Spacer measure C) 35.6 mm (Spacer measure E)
Mounting	at round cylinders
For	Cylinder sensores with T-Slot
Casing material	Aluminium / ring POM, (polyacetal - POM)
to be used for	Cylinder Ø 25 mm
Scope of delivery	Fixing material